

O

C

E

A

B



www.es-toolbox.com



BAHCO



Catálogo **2020**



Catálogo-Tarifa 2020

Catálogo-Tarifa

Contenido	2-9
Capítulos	
Sierras de cinta y otras sierras para máquinas	11-20
Limas	21-36
Llaves	37-62
Vasos y accesorios	63-112
Herramientas dinamométricas	113-130
Accesorios para herramientas eléctricas	131-168
Destornilladores	169-198
Llaves acodadas	199-208
Alicates	209-242
Llaves para tubos y herramientas para fontanería	243-248
Herramientas neumáticas	249-260
Herramienta electro portátil	261-266
Herramientas para automoción	267-326
Iluminación	327-330
Herramientas de inspección	331-334
Extractores	335-344
Almacenamiento de herramientas y composiciones	345-416
Herramientas para trabajos en altura	417-432
Herramientas aisladas	433-446
Herramientas antichispa	447-466
Herramientas de acero inoxidable	467-472
Pinzas y herramientas especiales para electrónica	473-480
Medición y trazado	481-488
Herramientas para Albañilería	489-496
Sierras manuales	497-500
Serruchos	501-508
Formones	509-514
Tijeras y cuchillos	515-524
Mordazas y tornillos de banco	525-528
Martillos	529-536
Herramientas forestales y de tala de árboles	537-540
Cinceles y punteros de chapista	541-548
Palancas	549-550
Herramientas para plantación y cultivo	551-554
Herramientas de poda	555-572
Herramientas neumáticas de exterior	573-576
Herramientas de precisión Lindström	577-590
Índice alfanumérico	551-665
Garantía	671

11-20 SIERRAS DE CINTA Y OTRAS SIERRAS PARA MÁQUINAS



21-36 LIMAS



37-62 LLAVES



63-112 VASOS Y ACCESORIOS



113-130 HERRAMIENTAS DINAMOMÉTRICAS



131-168 ACCESORIOS PARA HERRAMIENTAS ELÉCTRICAS



169-198 DESTORNILLADORES



199-208 LLAVES ACODADAS



209-242 ALICATES



243-248 LLAVES PARA TUBOS Y HERRAMIENTAS PARA FONTANERÍA



249-260 HERRAMIENTAS NEUMÁTICAS



261-266 HERRAMIENTA ELECTRO PORTÁTIL



267-326 HERRAMIENTAS PARA AUTOMOCIÓN



327-330 ILUMINACIÓN



331-334 HERRAMIENTAS DE INSPECCIÓN



335-344 EXTRACTORES



345-416 ALMACENAMIENTO DE HERRAMIENTAS Y COMPOSICIONES



417-432 HERRAMIENTAS PARA TRABAJOS EN ALTURA



433-446 HERRAMIENTAS AISLADAS



447-466 HERRAMIENTAS ANTICHISPA



467-472 HERRAMIENTAS DE ACERO INOXIDABLE



473-480 PINZAS Y HERRAMIENTAS ESPECIALES PARA ELECTRÓNICA



481-488 MEDICIÓN Y TRAZADO



489-496 HERRAMIENTAS PARA ALBAÑILERÍA



497-500 SIERRAS MANUALES



501-508 SERRUCHOS



509-514 FORMONES



515-524 TIJERAS Y CUCHILLOS



525-528 MORDAZAS Y TORNILLOS DE BANCO



529-536 MARTILLOS



537-540 HERRAMIENTAS FORESTALES Y DE TALA DE ÁRBOLES



541-548 CINCELES Y PUNTEROS DE CHAPISTA



549-550 PALANCAS



551-554 HERRAMIENTAS PARA PLANTACIÓN Y CULTIVO



555-572 HERRAMIENTAS DE PODA



573-576 HERRAMIENTAS NEUMÁTICAS DE EXTERIOR



577-590 HERRAMIENTAS DE PRECISIÓN LINDSTRÖM



Contenido

A		C	
ABOCINADOR	246	CABALLETES Y ACCESORIOS	324
ACCESORIOS 1/2"	87	CABEZAS INTERCAMBIABLES DINAMOMETRÍA	124
ACCESORIOS 1/4"	65	CAJAS DE ALBAÑIL	395
ACCESORIOS 1"	101	CAJAS METÁLICAS	395
ACCESORIOS 3/4"	98	CAJAS PLÁSTICO	411
ACCESORIOS 3/8"	77	CALIBRE PARA DISCOS DE FRENO	297
ACCESORIOS DE IMPACTO 1.1/2"	112	CALIBRES	488
ACCESORIOS DE IMPACTO 1/2"	105	CAMILLA TALLER	314
ACCESORIOS DE IMPACTO 1"	111	CARGADOR BATERÍAS	307
ACCESORIOS DE IMPACTO 3/4"	108	CARGADORES A BATERÍA	265
ACCESORIOS DE IMPACTO 3/8"	103	CARRACAS 1/2"	90
ACCESORIOS PARA CARROS	348	CARRACAS A BATERÍA	262
ACCESORIOS PARA LIMAS	34	CARRACAS NEUMÁTICAS	252
ACEITERA	291	CARRETES ENROLLADORES	259,329
ADAPTADORES 1/4"	156	CARRILES	494
ADAPTADORES PAR Y ÁNGULO	120	CARROS	346
AFILADOR PODA	570	CARROS INOX.	468
AJUSTABLES (1000V)	38 (442)	CENTRAFAROS	313
AJUSTABLES ANTI-CHISPA	448	CEÑIDOR SEGMENTOS PISTÓN	288
ALCOTANA	533	CEPILLO PARA BUJÍAS	283
ALICATE DE SIRGA	272	CEPILLO PARA CANTOS ESCAYOLA	492
ALICATE PARA ABRAZADERAS	304	CEPILLO PARA DISCOS DE FRENO	283
ALICATE PARA BUJÍAS	282	CEPILLO PARA TERMINALES	284
ALICATE PARA ESCAPES	290	CINCELES	542
ALICATES 1000V	440	CINCELES ANTI-CHISPA	462
ALICATES ANTI-CHISPA	458	CINCELES INOX.	472
ALICATES BOCA REDONDA	224	CINCELES NEUMÁTICOS	257
ALICATES BOCA SEMIRREDONDA	219	CIZALLA NEUMÁTICA	256
ALICATES CORTANTES (1000V)	210 (440)	COMPOSICIONES DE HTAS. EN FOAM	352
ALICATES DE ARANDELAS	227	COMPROBADOR ANTICONGELANTE	278
ALICATES DE BOCA PLANA	222	COMPROBADOR DE CALENTADORES	271
ALICATES DE CARRACA	232	COMPROBADOR DE LÍQUIDO DE FRENOS	298
ALICATES INOX.	472	COMPROBADOR DIGITAL DE PAR	123
ALICATES LINDSTRÖM	578	COMPROBADORES DE TENSIÓN	193
ALICATES PARA CONECTORES	223	COMPROBADORES ELÉCTRICOS	193
ALICATES PARA ELECTRÓNICA	211	CORONAS DE SIERRA Y JUEGOS	132
ALICATES PARA LATIGUILLOS	280	CORTACABLES	216
ALICATES PARA TERMINALES	226,231	CORTAFRÍOS	542
ALICATES PARA TUERCAS	224	CORTASETOS	565
ALICATES PELACABLES	229	CORTATUBOS	247
ALICATES PRECISIÓN	235	CORTAVARILLAS	217
ALICATES TRENZADORES	241	CUBREASIENTOS	313
ALICATES UNIVERSALES (1000V)	217 (441)	CUCHILLOS	490
ALMACENAMIENTO DE HERRAMIENTAS	345	CUÑAS ANTI-CHISPA	462
AMOLADORAS	253	CUTTERS	519
AMOLADORAS A BATERÍA	264	D	
ARCOS DE MARQUETERÍA Y HOJAS	507	DESMONTADOR DE VÁLVULAS	287
ARCOS DE SIERRA PARA METALES	498	DESMONTADOR NEUMÁTICOS	304
ARCOS TRONZADORES	567	DESPEGADOR DE PARABRISAS	256
ARMARIOS Y PANELES	393	DESTORNILLADOR ELECTRÓNICO	195
ARRANCADOR BATERÍAS	307	DESTORNILLADOR IMPACTO	157
ATORNILLADOR NEUMÁTICO	256	DESTORNILLADOR MANGO MADERA	195
B		DESTORNILLADORES 1000V	434
BANCOS DE TRABAJO	390	DESTORNILLADORES ACODADOS	207
BARRAS DE TORSIÓN	300	DESTORNILLADORES ANTI-CHISPA	457
BARRAS DESENCOFRADORAS	550	DESTORNILLADORES BAHCOFIT (1000V)	178 (437)
BATERIA PARA HTA ELECTROPORTÁTIL	265	DESTORNILLADORES DE CARRACA	188
BOLSAS PORTA HERRAMIENTAS	411	DESTORNILLADORES DINAMOMÉTRICOS	121, 589
BOMBA ENGRASE	295	DESTORNILLADORES DINAMOMÉTRICOS	121
BOOSTER	307	DESTORNILLADORES ERGO™ (1000V)	170 (434)
BOTADORES	544	DESTORNILLADORES INOX.	470
BROCAS	148	DESTORNILLADORES MANGO EN "T"	194
BROCAS ESCALONADAS	152	DESTORNILLADORES MANGO IMPACTO	187
BROCAS MADERA, METAL	153	DESTORNILLADORES PORTAPUNTAS 1/4"	195
BROCAS PILOTO Y SOPORTES PARA CORONAS	138	DESTORNILLADORES PRECISIÓN	191
BURILES	542	DESTORNILLADORES SERIE 600/SENSOR	184



DINAMOMÉTRICAS	113	IMANTADOR/DESIMANTADOR	197
DINAMOMÉTRICAS DIGITALES	118	J	
DINAMOMÉTRICAS MECÁNICAS	114	JUEGO DE ALICATES	236
DISCOS ABRASIVOS	253	JUEGO DE CALADO PARA MOTOR	268
DOBLADORES DE TUBO Y REPUESTOS	246	JUEGO DE PUNTAS 1/4"	165
E		JUEGO DE TERRAJAS	342
EMPUÑADURA 1000V	444	JUEGOS PARA ELECTRÓNICA Y ELECTRICISTA	415
ENDOSCOPIO	332	L	
ENGRASADORAS A BATERÍA	265	LÁMPARA UV	279
ENROLLADORES DE CABLE	259	LÁMPARAS Y ACCESORIOS	328
EQUIPAMIENTO PARA GARAJE	312	LÁPIZ CARPINTERO	487
EQUIPOS DE ELEVACIÓN	320	LIJADORAS	253
ESCOFINAS	33	LIJADORAS A BATERÍA	264
ESCUADRAS	487	LIMAS CON DIENTES FRESADOS	29
ESPÁTULAS	490	LIMAS DE AGUJA	26
ESPEJOS	333	LIMAS DE DIAMANTE	29
ESTETOSCOPIO	332	LIMAS DE MECÁNICO	22
EXTRACTOR DE CALENTADORES	280	LIMAS DOBLES PARA ROSCAS	342
EXTRACTOR DE CLAVOS	530	LIMAS PARA AFILADO	30
EXTRACTOR DE ESPÁRRAGOS	340	LIMAS ROTATIVAS CARBURO DE TUNGSTENO	143
EXTRACTOR DE FILTRO	291	LIMAS ROTATIVAS DE ACERO RÁPIDO	147
EXTRACTOR DE HUMOS	290	LIMPIADOR DE SUPERFICIES	257
EXTRACTOR DE INYECTORES	279	LLANAS	493
EXTRACTORES	335	LLAVE DE FLEJE	290
EXTRACTORES ANTI-CHISPA	465	LLAVES 1000V	442
F		LLAVES ACODADAS	200
FIJAS ALBAÑIL	532	LLAVES ACODADAS INOX.	471
FLEXÓMETROS Y CINTAS MÉTRICAS	482	LLAVES AJUSTABLES	38
FORMONES	510	LLAVES ANTI-CHISPA	448
G		LLAVES ARMARIOS CONTROL	60
GALGAS	488	LLAVES CARRACA PARA ESTRUCTURAS	112
GATOS Y ACCESORIOS	320	LLAVES COMBINADAS	40
GIRAMACHOS DE CARRACA	342	LLAVES DE CADENA	246
GONIÓMETROS	120	LLAVES DE CARRACA	45
GRANETES (ANTI-CHISPA)	543 (463)	LLAVES DE ESTRELLA DE DOS BOCAS	53
GRIPS	236	LLAVES DE GOLPEO	56
GRÚAS Y ACCESORIOS	325	LLAVES DE GOLPEO ANTI-CHISPA	450
GUANTES AISLADOS	445	LLAVES DE IMPACTO	250
GUBIAS	513	LLAVES DE TUBO	57
H		LLAVES EN CRUZ	303
HACHAS	538	LLAVES FIJAS	49
HERRAMIENTA ACERO INOX.IDABLE	467	LLAVES GANCHO ARTICULADA	61
HERRAMIENTA AISLADA	433	LLAVES HEXAGONALES INOX.	470
HERRAMIENTA ELECTROPORTÁTIL	262	LLAVES INOX.	468
HERRAMIENTAS ANTI-CHISPA	448	LLAVES PARA BUJÍAS	284
HERRAMIENTAS DE INSPECCIÓN	332	LLAVES PARA CÁRTER	292
HERRAMIENTAS DE PODA	555	LLAVES PARA RACORES	55
HERRAMIENTAS DE PRECISIÓN LINDSTRÖM	578	LLAVES PARA TUBOS	244
HERRAMIENTAS DINAMOMÉTRICAS	114	LLAVES PARA TUERCAS LAVABO	245
HERRAMIENTAS PARA ALBAÑILERÍA	489	LLAVES STILLSON (ANTI-CHISPA)	245 (452)
HERRAMIENTAS PARA CARROCERÍA	314	LLAVES VÁLVULAS ANTI-CHISPA	453
HERRAMIENTAS PARA ELECTRÓNICA	474	LUBRICADOR 1/4"	258
HERRAMIENTAS PARA ESCAYOLA	493	LUPA	480
HERRAMIENTAS PARA MOTOR	268	M	
HERRAMIENTAS PARA RUEDAS Y TRANSMISIÓN	299	MACETAS	531
HERRAMIENTAS PARA SERVICIO DE ACEITE	290	MAGNETIZADOR/DESMAGNETIZADOR	197
HERRAMIENTAS PARA SISTEMA DE FRENADO	297	MALETAS RÍGIDAS Y COMPOSICIONES	396
HERRAMIENTAS PARA SUSPENSIÓN	305	MANGOS PARA SERRUCHOS	506
HERRAMIENTAS PARA TRABAJOS EN ALTURA	417	MANGUERA ESPIRAL	259
HERRAMIENTAS PLANTACIÓN Y CULTIVO	551	MARCADOR NEUMÁTICO	258
HOJAS DE CALAR	142	MARTILLO ANTI-REBOTE	533
HOJAS DE SABLE	139	MARTILLO DE INERCIA	302
HOJAS DE SIERRA DE MANO	499	MARTILLO PARA CARROCERÍA	316
HOJAS DE SIERRA DE MÁQUINA	19	MARTILLOS	529
HOJAS PARA TRONZAR	568	MARTILLOS ANTI-CHISPA	460
I		MARTILLOS DE CONSTRUCCIÓN	531
ILUMINACIÓN	328	MARTILLOS DE MECÁNICO	530

MARTILLOS INOX.	472	REMACHADORA NEUMÁTICA	257
MAZAS	534	REMACHADORA PARA TUERCAS	319
MEDICIÓN Y TRAZADO	481	REMACHADORAS MANUALES	239
MINI AMOLADORAS	253	RUEDAS DE MEDICIÓN	483
MINI RADIAL	253	S	
MORDAZAS GRIP	236	SACABOCADOS	546
MORDAZAS Y TORNILLOS DE BANCO	525	SACABOCADOS	546
MULTIHERRAMIENTA	523	SERRUCHOS	501
MULTÍMETRO	309	SERRUCHOS DE PODA	568
MULTIPLICADORES DE PAR	129	SERRUCHOS DE PRECISIÓN	506
N		SERRUCHOS PARA ESCAYOLA	502
NAVAJAS	522	SERRUCHOS PARA MADERA	503
NAVAJAS PARA INJERTAR	566	SIERRA DE CINTA	12
NIVELES	484	SIERRA VAIVÉN	256
P		SIERRAS CIRCULARES	142
PALANCAS	342	SIERRAS MANUALES	497
PALANCAS	549	SISTEMAS APRIETE DINAMOMETRÍA	130
PALANCAS INOX.	472	SOLDADORES	478
PALANCAS ANTI-CHISPA	462	SOPORTES PARA LUNAS Y CARROCERÍA	314
PALAS	552	T	
PALETAS DE ALBAÑIL	494	TABURETE TALLER	314
PANELES PARA HERRAMIENTAS	351	TACÓMETRO	18
PELACABLES	229	TALADROS NEUMÁTICOS	256
PELAMANGUERAS	231	TALADROS Y ATORNILLADORES A BATERÍA	263
PERFORADORES DE CHAPA	546	TALOCHAS	494
PÉRTIGAS TELESCÓPICAS	563	TASES	317
PICOS	532	TENACILLAS ARTICULADAS AJUSTE RÁPIDO	225
PICOS Y PALAS ANTI-CHISPA	464	TENACILLAS DE CREMALLERA	226
PIEDRAS DE AFILAR	513	TENAZAS	239
PINZAS 1000V	444	TENSÍMETRO	277
PINZAS LINDSTRÖM	582	TENSIÓMETRO	18
PINZAS PARA ELECTRÓNICA	474	SENSOR PARA ABRAZADERAS DE NYLON	240
PINZAS PARA UNIR PERFILES	493	TERMÓMETRO INFRARROJOS	278
PISTOLA DE PINTAR	258	TIJERA ELECTRICISTA (1000V)	518 (444)
PISTOLAS DE IMPACTO	250	TIJERAS PARA CHAPA	516
PISTOLAS DE IMPACTO A BATERÍA	262	TIJERAS PARA INGLETES	492
PISTOLAS DE SOPLADO	259	TIJERAS PARA PODA Y RECAMBIOS	556
PLOMADAS Y POLVO COLORANTE	486	TIJERAS Y CUCHILLOS	515
PODA EN ALTURA	562	TIJERAS Y CUCHILLOS 1000V	444
PODADERAS NEUMÁTICAS	574	TORNILLOS DE BANCO	527
PORTA HERRAMIENTAS Y CINTURONES	413	TRANSPORTADORES	352
PRENSAS Y ACCESORIOS	312	TRONZATUERCAS	340
PRENSATERMINALES	235	U	
PULIDORAS A BATERÍA	264	ÚTILES DE SINTONIZACIÓN	480
PULIDORAS NEUMÁTICAS	253	V	
PUNTAS 10MM	286	VARILLAS DESTORNILLADOR HEXAGONALES 1/4"	189
PUNTAS 5/16"	157	VASOS 1/2"	85
PUNTAS 5/32"	163	VASOS 1/4"	63
PUNTAS 7/16"	158	VASOS 1"	100
PUNTAS ACR 1/4"	154	VASOS 3/4"	97
PUNTAS CON ROSCA	166	VASOS 3/8"	76
PUNTAS DE DIAMANTE 1/4"	154	VASOS CON PUNTA 1/2"	88
PUNTAS DE TORSIÓN 1/4"	154	VASOS CON PUNTA 1/4"	67
PUNTAS ESTÁNDAR 1/4"	159	VASOS CON PUNTA 3/8"	80
PUNTAS EXTRA DURAS 1/4"	155	VASOS DE IMPACTO 1.1/2"	111
PUNTAS EXTRACTORAS DE ESPÁRRAGOS	341	VASOS DE IMPACTO 1/2"	104
PUNTAS INOX.	471	VASOS DE IMPACTO 1/4"	102
PUNTAS TIN 1/4"	166	VASOS DE IMPACTO 1"	109
R		VASOS DE IMPACTO 3/4"	107
RASQUETA	490	VASOS DE IMPACTO 3/8"	103
RASQUETAS ANTI-CHISPA	463	VASOS PARA BUJÍAS	263
RASTRILLOS Y AZADAS	552	VASOS PARA RUEDAS	301
REBABADORES	248	VASOS Y ACCESORIOS 1000V	443
RECOGEDORA DE ACEITE	293	VASOS Y ACCESORIOS ANTI-CHISPA	453
REFRACTÓMETRO	18, 278	VASOS Y ACCESORIOS INOX.	469
REGULADOR Y FILTRO 1/2"	258		
RELOJ COMPARADOR	297		



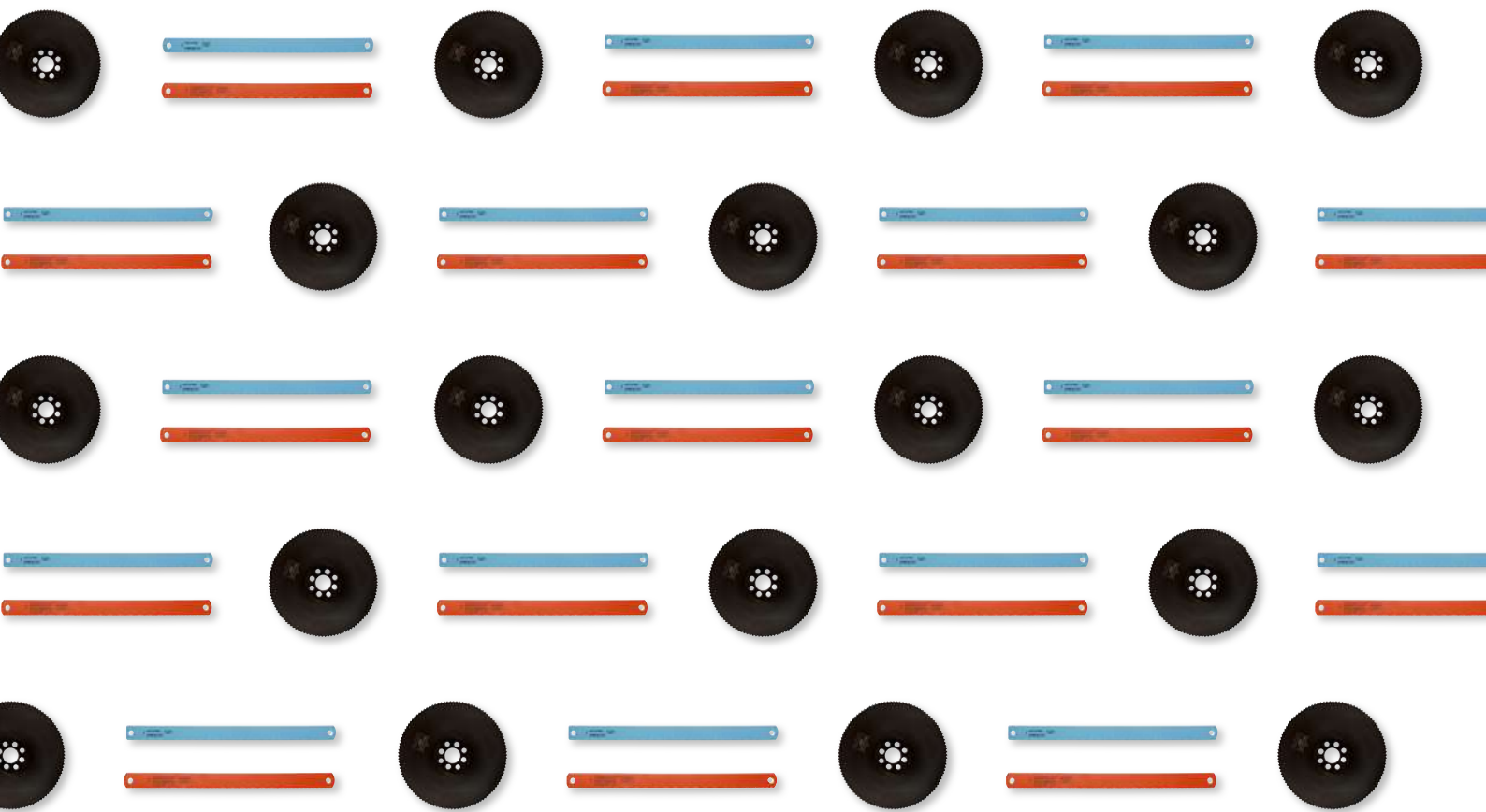

Sierras de cinta y otras sierras para máquinas







SIERRAS DE CINTA BIMETÁLICAS PARA EL CORTE DE METAL

Sierra cinta Easy Cut
Dentado patentado multiuso







3857 Easy-Cut

			
13	EZ	1	3857-13-0.5-EZ-S
13	EZ	1	3857-13-0.6-EZ-S
13	EZ	1	3857-13-0.6-EZ-M
13	EZ	1	3857-13-0.6-EZ-L
13	EZ	1	3857-13-0.9-EZ-S
20	EZ	1	3857-20-0.9-EZ-S
20	EZ	1	3857-20-0.9-EZ-M
20	EZ	1	3857-20-0.9-EZ-L
27	EZ	1	3857-27-0.9-EZ-S
27	EZ	1	3857-27-0.9-EZ-M
27	EZ	1	3857-27-0.9-EZ-L
34	EZ	1	3857-34-1.1-EZ-S
34	EZ	1	3857-34-1.1-EZ-M
34	EZ	1	3857-34-1.1-EZ-L





Sandflex® Cobra™



3851 Contour and small machine

			
20	R	1	3851-20-0.9-R-18
6	Hook	1	3851-6-0.6-H-6
6	PRX	1	3851-6-0.6-10/14
6	Hook	1	3851-6-0.9-H-6





BAHCO





			
6	PRX	1	3851-6-0.9-10/14
10	Hook	1	3851-10-0.6-H-4
10	Hook	1	3851-10-0.6-H-6
10	PRX	1	3851-10-0.6-10/14
10	Hook	1	3851-10-0.9-H-4
10	Hook	1	3851-10-0.9-H-6
10	Regular	1	3851-10-0.9-R-14
10	PRX	1	3851-10-0.9-10/14
13	Regular	1	3851-13-0.5-R-10
13	PRX	1	3851-13-0.5-10/14
13	Regular	1	3851-13-0.5-R-14
13	PRX	1	3851-13-0.5-14/18
13	Regular	1	3851-13-0.5-R-18
13	Regular	1	3851-13-0.5-R-24
13	PRX	1	3851-13-0.6-5/8
13	PRX	1	3851-13-0.6-6/10
13	PRX	1	3851-13-0.6-8/12
13	PRX	1	3851-13-0.6-10/14
13	Hook	1	3851-13-0.6-H-3
13	Hook	1	3851-13-0.6-H-4
13	Hook	1	3851-13-0.6-H-6
13	Regular	1	3851-13-0.6-R-10
13	Regular	1	3851-13-0.6-R-14
13	Regular	1	3851-13-0.6-R-18
13	PRX	1	3851-13-0.9-6/10
13	PRX	1	3851-13-0.9-10/14
13	Hook	1	3851-13-0.9-H-3
13	Hook	1	3851-13-0.9-H-4
13	Regular	1	3851-13-0.9-R-6
13	Hook	1	3851-13-0.9-H-6
13	Regular	1	3851-13-0.9-R-14
16	Hook	1	3851-16-0.5-H-3
20	H	1	3851-20-0.9-H-2
20	H	1	3851-20-0.9-H-3
20	H	1	3851-20-0.9-H-4
20	PRX	1	3851-20-0.9-4/6
20	PRX	1	3851-20-0.9-5/8
20	PRX	1	3851-20-0.9-6/10
20	PRX	1	3851-20-0.9-8/12
20	PRX	1	3851-20-0.9-10/14
27	PS	1	3851-27-0.9-P-3
27	PS	1	3851-27-0.9-P-4
27	Regular	1	3851-27-0.9-R-6
27	PRX	1	3851-27-0.9-2/3
27	PRX	1	3851-27-0.9-3/4
27	PRX	1	3851-27-0.9-4/6
27	PRX	1	3851-27-0.9-5/8
27	PRX	1	3851-27-0.9-6/10
27	PRX	1	3851-27-0.9-8/12
27	PRX	1	3851-27-0.9-10/14

Sandflex® Cobra™



3851 Sandflex® Cobra™





			
34	PRX	1	3851-34-1.1-2/3
34	PRX	1	3851-34-1.1-3/4





			
34	PRX	1	3851-34-1.1-4/6
34	PRX	1	3851-34-1.1-5/8
34	PRX	1	3851-34-1.1-6/10
41	PRX	1	3851-41-1.3-1.4/2
41	PRX	1	3851-41-1.3-2/3
41	PRX	1	3851-41-1.3-3/4
41	PRX	1	3851-41-1.3-4/6
41	PRX	1	3851-41-1.3-5/8
54	PRX	1	3851-54-1.3-2/3
54	PRX	1	3851-54-1.3-4/6
54	PRX	1	3851-54-1.6-1/1.4
54	PRX	1	3851-54-1.6-1.4/2
54	PRX	1	3851-54-1.6-2/3
54	PRX	1	3851-54-1.6-3/4
67	PRX	1	3851-67-1.6-7/1
67	PRX	1	3851-67-1.6-1/1.4
67	PRX	1	3851-67-1.6-1.4/2
67	PRX	1	3851-67-1.6-2/3
67	PRX	1	3851-67-1.6-3/4
67	PRX	1	3851-67-1.6-4/6
80	PRX	1	3851-80-1.6-7/1
80	PRX	1	3851-80-1.6-1/1.4
80	PRX	1	3851-80-1.6-1.4/2

Sandflex® King Cobra™ PHG



3854-Sandflex® King Cobra™ PHG





			
27	PHG	1	3854-27-0.9-PHG-3/4
27	PHG	1	3854-27-0.9-PHG-4/6
34	PHG	1	3854-34-1.1-PHG-1.4/2
34	PHG	1	3854-34-1.1-PHG-2/3
34	PHG	1	3854-34-1.1-PHG-3/4
34	PHG	1	3854-34-1.1-PHG-4/6
41	PHG	1	3854-41-1.3-PHG-1.4/2
41	PHG	1	3854-41-1.3-PHG-2/3
41	PHG	1	3854-41-1.3-PHG-3/4
41	PHG	1	3854-41-1.3-PHG-4/6
54	PHG	1	3854-54-1.3-PHG-1.4/2
54	PHG	1	3854-54-1.6-PHG-7/1

			
54	PHG	1	3854-54-1.6-PHG-1.4/2
54	PHG	1	3854-54-1.6-PHG-2/3
67	PHG	1	3854-67-1.6-PHG-7/1
67	PHG	1	3854-67-1.6-PHG-1/1.4
67	PHG	1	3854-67-1.6-PHG-1.4/2
67	PHG	1	3854-67-1.6-PHG-2/3
80	PHG	1	3854-80-1.6-PHG-7/1
80	PHG	1	3854-80-1.6-PHG-1.4/2

Sandflex® King Cobra™ PQ



3854-Sandflex® King Cobra™ PQ





			
27	PQ	1	3854-27-0.9-PQ-3/4
27	PQ	1	3854-27-0.9-PQ-4/6
34	PQ	1	3854-34-1.1-PQ-2/3
34	PQ	1	3854-34-1.1-PQ-3/4
34	PQ	1	3854-34-1.1-PQ-4/6
41	PQ	1	3854-41-1.3-PQ-1.4/2
41	PQ	1	3854-41-1.3-PQ-2/3
41	PQ	1	3854-41-1.3-PQ-3/4
41	PQ	1	3854-41-1.3-PQ-4/6
54	PQ	1	3854-54-1.6-PQ-9/1.2
54	PQ	1	3854-54-1.6-PQ-1.4/2
54	PQ	1	3854-54-1.6-PQ-2/3
54	PQ	1	3854-54-1.6-PQ-3/4
54	PQ	1	3854-54-1.6-PQ-4/6
67	PQ	1	3854-67-1.6-PQ-9/1.2
67	PQ	1	3854-67-1.6-PQ-1.4/2
67	PQ	1	3854-67-1.6-PQ-2/3
67	PQ	1	3854-67-1.6-PQ-3/4
80	PQ	1	3854-80-1.6-PQ-9/1.2
80	PQ	1	3854-80-1.6-PQ-1.4/2
80	PQ	1	3854-80-1.6-PQ-2/3
80	PQ	1	3854-80-1.6-PQ-3/4



Sandflex® King Cobra™ PHG P9000





3858 PHG P9000



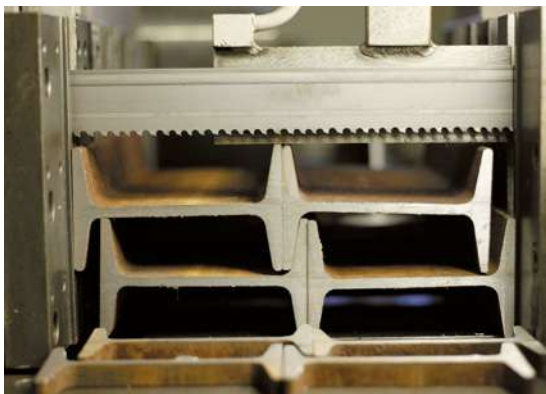

			
1.4/2	PHG P9000	1	3858-41-1.3-PHG-1.4/2
2/3	PHG P9000	1	3858-41-1.3-PHG-2/3
3/4	PHG P9000	1	3858-41-1.3-PHG-3/4
2/3	PHG P9000	1	3858-54-1.3-PHG-2/3
3/4	PHG P9000	1	3858-54-1.3-PHG-3/4
.7/1	PHG P9000	1	3858-54-1.6-PHG-.7/1
1.4/2	PHG P9000	1	3858-54-1.6-PHG-1.4/2
2/3	PHG P9000	1	3858-54-1.6-PHG-2/3
.7/1	PHG P9000	1	3858-67-1.6-PHG-.7/1
1/1.4	PHG P9000	1	3858-67-1.6-PHG-1/1.4
1.4/2	PHG P9000	1	3858-67-1.6-PHG-1.4/2
.7/1	PHG P9000	1	3858-80-1.6-PHG-.7/1
1.4/2	PHG P9000	1	3858-80-1.6-PHG-1.4/2

Sandflex® Top Fabricator



3853 Sandflex® Top Fabricator





			
20	PF	1	3853-20-0.9-5/7-VS
20	PF	1	3853-20-0.9-8/11-VS

			
27	PF	1	3853-27-0.9-3/4
27	PF	1	3853-27-0.9-4/6
27	PF	1	3853-27-0.9-5/8
27	PF	1	3853-27-0.9-5/7-VS
27	PF	1	3853-27-0.9-8/11-VS
34	PF	1	3853-34-1.1-2/3
34	PF	1	3853-34-1.1-3/4
34	PF	1	3853-34-1.1-4/6
34	PF	1	3853-34-1.1-5/8
34	PF	1	3853-34-1.1-5/7-VS
34	PF	1	3853-34-1.1-8/11-VS
41	PF	1	3853-41-1.3-2/3
41	PF	1	3853-41-1.3-3/4
41	PF	1	3853-41-1.3-4/6
41	PF	1	3853-41-1.3-5/8
41	PF	1	3853-41-1.3-5/7-VS
54	PF	1	3853-54-1.3-3/4-W
54	PF	1	3853-54-1.3-5/8
54	PF	1	3853-54-1.6-2/3
54	PF	1	3853-54-1.6-3/4
54	PF	1	3853-54-1.6-4/6
67	PF	1	3853-67-1.6-2/3
67	PF	1	3853-67-1.6-3/4

Sandflex® Cobra™ Fundición



3851 Sandflex® Cobra™ Foundry



			
10	Hook	1	3851-10-0.6-HA-4
13	Hook	1	3851-13-0.5-H-4
13	HA	1	3851-13-0.6-HA-4
13	HA	1	3851-13-0.6-HA-6
13	HA	1	3851-13-0.9-HA-4
20	Hook	1	3851-20-0.9-HA-2
20	HA	1	3851-20-0.9-HA-3
20	Hook	1	3851-20-0.9-HA-4
27	HA	1	3851-27-0.9-HA-4
27	HA	1	3851-27-0.9-HA-3

SIERRAS DE CINTA DE METAL DURO PARA METAL

3860 TCD - Sierra cinta Metal Duro sin triscado





3860 Unset Carbide TCD

			
27	TCD	1	3860-27-0.9-TCD-3
27	TCD	1	3860-27-0.9-TCD-3/4
34	TCD	1	3860-34-1.1-TCD-2/3
34	TCD	1	3860-34-1.1-TCD-3/4
34	TCD	1	3860-34-1.1-TCD-3/4-W
41	TCD	1	3860-41-1.3-TCD-1.4/2
41	TCD	1	3860-41-1.3-TCD-1.9/2.1
41	TCD	1	3860-41-1.3-TCD-2/3
41	TCD	1	3860-41-1.3-TCD-3/4
41	TCD	1	3860-41-1.3-TCD-3/4WB
54	TCD	1	3860-54-1.6-TCD-1.4/2
54	TCD	1	3860-54-1.6-TCD-1.4/2WB
54	TCD	1	3860-54-1.6-TCD-1.9/2.1
54	TCD	1	3860-54-1.6-TCD-2/3
54	TCD	1	3860-54-1.6-TCD-3/4

3860 TCA- Sierra cinta sin triscado multiviruta



3860 Unset Carbide TCA



			
27	TCA	1	3860-27-0.9-TCA-3
34	TCA	1	3860-34-1.1-TCA-2
34	TCA	1	3860-34-1.1-TCA-2/3
34	TCA	1	3860-34-1.1-TCA-3
41	TCA	1	3860-41-1.3-TCA-1.4/2
41	TCA	1	3860-41-1.3-TCA-2/3
54	TCA	1	3860-54-1.6-TCA-1/1.25
54	TCA	1	3860-54-1.6-TCA-1.4/2

Geometría del diente especial para aluminio

Carbide Triple Set® "Xtra"™



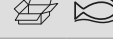

3868 Carbide Triple Set® TSX

			
27	TSX	1	3868-27-0.9-TSX-3/4
34	TSX	1	3868-34-1.1-TSX-2/3
34	TSX	1	3868-34-1.1-TSX-3/4
41	TSX	1	3868-41-1.3-TSX-1.4/2
41	TSX	1	3868-41-1.3-TSX-1.6
41	TSX	1	3868-41-1.3-TSX-2/3
41	TSX	1	3868-41-1.3-TSX-3/4
54	TSX	1	3868-54-1.3-TSX-1.4/2
54	TSX	1	3868-54-1.6-TSX-1/1.25
54	TSX	1	3868-54-1.6-TSX-1.4/2
54	TSX	1	3868-54-1.6-TSX-1.6
54	TSX	1	3868-54-1.6-TSX-2/3
54	TSX	1	3868-54-1.6-TSX-3/4
67	TSX	1	3868-67-1.6-TSX-.7/1
67	TSX	1	3868-67-1.6-TSX-1/1.25
67	TSX	1	3868-67-1.6-TSX-1.4/2
80	TSX	1	3868-80-1.1-TSX-3/4
67	TSx	1	3868-67-1.6-TSX-2/3
80	TSx	1	3868-80-1.6-TSX-.7/1
80	TSx	1	3868-80-1.6-TSX-2/3

Carbide TSS Triple Set



3868 Carbide Triple Set® TSS



			
34	TSS	1	3868-34-1.1-TSS-2/3
41	TSS	1	3868-41-1.3-TSS-1.4/2
41	TSS	1	3868-41-1.3-TSS-2/3
54	TSS	1	3868-54-1.6-TSS-1/1.25
54	TSS	1	3868-54-1.6-TSS-1.4/2
54	TSS	1	3868-54-1.6-TSS-2/3
67	TSS	1	3868-67-1.6-TSS-.7/1
67	TSS	1	3868-67-1.6-TSS-1/1.25
67	TSS	1	3868-67-1.6-TSS-1.4/2
67	TSS	1	3868-67-1.6-TSS-2/3
80	TSS	1	3868-80-1.6-TSS-.7/1
80	TSS	1	3868-80-1.6-TSS-1.4/2



Carbide Triple Set





3869 Carbide Triple Set®

			
34	TS	1	3869-34-1.1-TS-2
13	TS	1	3869-13-0.9-TS-3
20	TS	1	3869-20-0.9-TS-3
20	TS	1	3869-20-0.9-TS-4
27	TS	1	3869-27-0.9-TS-3
27	TS	1	3869-27-0.9-TS-4
34	TS	1	3869-34-1.1-TS-3

3881 Carbide Multi Chip THQ





3881 Carbide Multi Set THQ

			
34	THQ	1	3881-34-1.1-THQ-2/3
41	THQ	1	3881-41-1.3-THQ-1.4/2
41	THQ	1	3881-41-1.3-THQ-2/3
54	THQ	1	3881-54-1.6-THQ-1.4/2
54	THQ	1	3881-54-1.6-THQ-2/3
67	THQ	1	3881-67-1.6-THQ-1/1.25
67	THQ	1	3881-67-1.6-THQ-1.4/2
80	THQ	1	3881-80-1.6-THQ-1/1.25
67	THQ	1	3881-67-1.6-THQ-2/3
80	THQ	1	3881-80-1.6-THQ-7/1
80	THQ	1	3881-80-1.6-THQ-1.4/2
80	THQ	1	3881-80-1.6-THQ-2/3

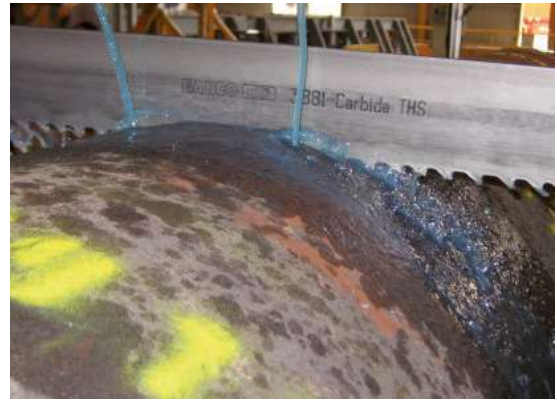
3881 Carbide Multi Chip THS





3881 Carbide Multi Set THS

			
100	THS	1	3881-100-1.6-THS-7/1
41	THS	1	3881-41-1.3-THS-1.4/2
54	THS	1	3881-54-1.6-THS-1/1.25
54	THS	1	3881-54-1.6-THS-1.4/2
67	THS	1	3881-67-1.6-THS-1/1.25
67	THS	1	3881-67-1.6-THS-1.4/2
67	THS	1	3881-67-1.6-THS-2/3
80	THS	1	3881-80-1.6-THS-7/1
80	THS	1	3881-80-1.6-THS-1.4/2
80	THS	1	3881-80-1.6-THS-2/3

Sierra cinta 3860 Carbide dentado especial para Titanio



3860 Unset Carbide TMC

			
41	TMC	1	3860-41-1.3-TMC-1.4/2
41	TMC	1	3860-41-1.3-TMC-2/3
54	TMC	1	3860-54-1.3-TMC-1.4/2
54	TMC	1	3860-54-1.3-TMC-2/3
54	TMC	1	3860-54-1.6-TMC-7/1
54	TMC	1	3860-54-1.6-TMC-1/1.25
54	TMC	1	3860-54-1.6-TMC-1.4/2
54	TMC	1	3860-54-1.6-TMC-2/3
67	TMC	1	3860-67-1.6-TMC-1/1.25
67	TMC	1	3860-67-1.6-TMC-1.4/2
67	TMC	1	3860-67-1.6-TMC-2/3
80	TMC	1	3860-80-1.6-TMC-7/1
80	TMC	1	3860-80-1.6-TMC-1/1.25
80	TMC	1	3860-80-1.6-TMC-1.4/2
80	TMC	1	3860-80-1.6-TMC-2/3

3860 TCZ - Sierra cinta metal duro sin triscado



3860 Unset Carbide TCZ

27	TCZ		1	3860-27-0.9-TCZ-3/4
34	TCZ		1	3860-34-1.1-TCZ-2/3
34	TCZ		1	3860-34-1.1-TCZ-3/4
41	TCZ		1	3860-41-1.3-TCZ-2/3
41	TCZ		1	3860-41-1.3-TCZ-3/4

Dentado especial para corte
barras tratadas al cromo duro

SIERRAS CIRCULARES DE ACERO RAPIDO

Sierra circular acero rápido



3815-32-1

200	BW3	1	3815-200-2.0-32-1-03BW
200	BW4	1	3815-200-2.0-32-1-04BW
225	BW3	1	3815-225-2.0-32-1-03BW
225	BW4	1	3815-225-2.0-32-1-04BW
225	BW5	1	3815-225-2.0-32-1-05BW
225	C6	1	3815-225-2.0-32-1-06C
250	BW3	1	3815-250-2.0-32-1-03BW
250	BWS3	1	3815-250-2.0-32-1-03BWS
250	BW4	1	3815-250-2.0-32-1-04BW
250	BWS4	1	3815-250-2.0-32-1-04BWS
250	BW5	1	3815-250-2.0-32-1-05BW
250	C6	1	3815-250-2.0-32-1-06C
275	BW4	1	3815-275-2.5-32-1-04BW
275	BWS4	1	3815-275-2.5-32-1-04BWS
275	BW5	1	3815-275-2.5-32-1-05BW
275	C6	1	3815-275-2.5-32-1-06C
275	C8	1	3815-275-2.5-32-1-08C
300	BW4	1	3815-300-2.5-32-1-04BW
300	BW5	1	3815-300-2.5-32-1-05BW
300	C5	1	3815-300-2.5-32-1-05C
300	C6	1	3815-300-2.5-32-1-06C

300	C8	1	3815-300-2.5-32-1-08C
315	BW4	1	3815-315-2.5-32-1-04BW
315	BW5	1	3815-315-2.5-32-1-05BW
315	C6	1	3815-315-2.5-32-1-06C
315	C8	1	3815-315-2.5-32-1-08C
350	BW4	1	3815-350-2.5-32-1-04BW
350	C6	1	3815-350-2.5-32-1-06C

Sierra circular en acero rápido



3815-40-2

250	BW3	1	3815-250-2.0-40-2-03BW
250	BW4	1	3815-250-2.0-40-2-04BW
250	BW5	1	3815-250-2.0-40-2-05BW
275	BW3	1	3815-275-2.5-40-2-03BW
275	BW4	1	3815-275-2.5-40-2-04BW
275	BW5	1	3815-275-2.5-40-2-05BW
275	C6	1	3815-275-2.5-40-2-06C
275	C8	1	3815-275-2.5-40-2-08C
315	BW4	1	3815-315-2.5-40-2-04BW
315	BW5	1	3815-315-2.5-40-2-05BW
315	C6	1	3815-315-3.0-40-2-06C

Sierra circular en acero rápido



3815-50-4

370	C8	1	3815-370-3.0-50-4-08C
370	C10	1	3815-370-3.0-50-4-10C
400	C10	1	3815-400-3.5-50-4-10C





733549_WOOD CUTTING

Sandcut® Sólido



3862 Sandcut Solid



		
1.15	Hook	1 3862-33-0.9-H-1.15
1.15	Hook	1 3862-33-1.1-H-1.15
1.15	Hook	1 3862-40-1.1-H-1.15

ACCESORIOS PARA SIERRAS DE CINTA

Cepillo de virutas



3870-BRUSH

	
60 mm	4 3870-BRUSH-60-6
80 mm	4 3870-BRUSH-80-6
80 mm	4 3870-BRUSH-80-8
80 mm	4 3870-BRUSH-80-10
100 mm	4 3870-BRUSH-100-10
100 mm	4 3870-BRUSH-100-12
100 mm	4 3870-BRUSH-100-10-HEX
100 mm	1 3870-BRUSH-100-13

Tacómetro



3870-TACHO

	
400	1 3870-TACHO METER

Tensiómetro



3870-TENSION

	
680	1 3870-TENSION METER

Refractómetro



3870-REFR

	
260	1 3870-REFRACTOMETER

CD con parámetros de sierra cinta Bahco



3870-CALC



45



1 3870-BANDCALC

Cuña metálica larga, 75mm



3870-WEDGE



60



1 3870-WEDGE-3

HOJAS DE SIERRA DE MÁQUINA

Hoja de sierra para máquinas Sandflex® Bi-metal Sandflex® bi-metal



3809



10
14
6



73
73
120



10 3809-300-25-1.25-10
10 3809-300-25-1.25-14
10 3809-300-32-1.60-6



10	120	10	3809-300-32-1.60-10
6	88	10	3809-350-25-1.25-6
10	88	10	3809-350-25-1.25-10
14	88	10	3809-350-25-1.25-14
4	145	10	3809-350-32-1.60-4
6	145	10	3809-350-32-1.60-6
8	145	10	3809-350-32-1.60-8
10	145	10	3809-350-32-1.60-10
14	145	10	3809-350-32-1.60-14
4	159	10	3809-350-32-2.00-4
6	159	10	3809-350-32-2.00-6
10	159	10	3809-350-32-2.00-10
6	204	10	3809-350-38-2.00-6
10	204	10	3809-350-38-2.00-10
10	108	10	3809-400-25-1.25-10
4	160	10	3809-400-32-1.60-4
6	160	10	3809-400-32-1.60-6
8	160	10	3809-400-32-1.60-8
10	160	10	3809-400-32-1.60-10
14	160	10	3809-400-32-1.60-14
4	184	10	3809-400-32-2.00-4
6	184	10	3809-400-32-2.00-6
8	184	10	3809-400-32-2.00-8
10	184	10	3809-400-32-2.00-10
4	219	10	3809-400-38-2.00-4
6	219	10	3809-400-38-2.00-6
10	219	10	3809-400-38-2.00-10
6	170	10	3809-425-32-1.60-6
10	170	10	3809-425-32-1.60-10
4	177	10	3809-450-32-1.60-4
6	177	10	3809-450-32-1.60-6
10	177	10	3809-450-32-1.60-10
14	177	10	3809-450-32-1.60-14
4	209	10	3809-450-32-2.00-4
6	209	10	3809-450-32-2.00-6
10	209	10	3809-450-32-2.00-10
4	249	10	3809-450-38-2.00-4
6	249	10	3809-450-38-2.00-6
8	249	10	3809-450-38-2.00-8
10	249	10	3809-450-38-2.00-10
4	358	10	3809-450-45-2.25-4
6	358	10	3809-450-45-2.25-6
6	378	10	3809-475-45-2.25-6
4	304	10	3809-500-38-2.00-4
6	304	10	3809-500-38-2.00-6
10	304	10	3809-500-38-2.00-10
4	398	10	3809-500-45-2.25-4
6	398	10	3809-500-45-2.25-6
4	513	10	3809-500-50-2.50-4
6	513	10	3809-500-50-2.50-6
8	513	10	3809-500-50-2.50-8
6	314	10	3809-525-38-2.00-6
10	314	10	3809-525-38-2.00-10
4	423	10	3809-525-45-2.25-4
6	423	10	3809-525-45-2.25-6
4	433	10	3809-550-45-2.25-4
6	433	10	3809-550-45-2.25-6
4	553	10	3809-550-50-2.50-4
6	553	10	3809-550-50-2.50-6
4	453	10	3809-575-45-2.25-4
3	568	10	3809-575-50-2.50-3
4	568	10	3809-575-50-2.50-4
6	568	10	3809-575-50-2.50-6
6	356	10	3809-600-38-2.00-6
4	478	10	3809-600-45-2.25-4
6	478	10	3809-600-45-2.25-6
3	588	10	3809-600-50-2.50-3
4	588	10	3809-600-50-2.50-4
6	588	10	3809-600-50-2.50-6
4	634	5	3809-650-50-2.50-4
6	634	5	3809-650-50-2.50-6
4	679	5	3809-700-50-2.50-4
6	679	5	3809-700-50-2.50-6
4	690	5	3809-750-50-2.50-4
6	690	5	3809-750-50-2.50-6



Sandflex® Bi-metal hoja de sierra para máquina KASTO



3809 KA



6	10	3809-400-32-2.00-6-KA
4	10	3809-450-38-2.00-4-KA
6	10	3809-450-38-2.00-6-KA
10	10	3809-450-38-2.00-10-KA
6	10	3809-500-45-2.25-6-KA
4	10	3809-500-50-2.50-4-KA
6	10	3809-500-50-2.50-6-KA
4	10	3809-550-50-2.50-4-KA
6	10	3809-550-50-2.50-6-KA
3	10	3809-575-50-2.50-3-KA
4	10	3809-575-50-2.50-4-KA
6	10	3809-575-50-2.50-6-KA
10	10	3809-575-50-2.50-10-KA
4	10	3809-600-50-2.50-4-KA
6	10	3809-600-50-2.50-6-KA
3	5	3809-650-50-2.50-3-KA
4	5	3809-650-50-2.50-4-KA
6	5	3809-650-50-2.50-6-KA
3	5	3809-700-50-2.50-3-KA
4	5	3809-700-50-2.50-4-KA
6	5	3809-700-50-2.50-6-KA

Hoja de sierra para máquinas HSS Acero rápido



3802



6	10	3802-300-25-1.25-6
10	10	3802-300-25-1.25-10
14	10	3802-300-25-1.25-14
6	10	3802-300-32-1.60-6
10	10	3802-300-32-1.60-10
6	10	3802-350-25-1.25-6
10	10	3802-350-25-1.25-10
14	10	3802-350-25-1.25-14
4	10	3802-350-32-1.60-4
6	10	3802-350-32-1.60-6
8	10	3802-350-32-1.60-8
10	10	3802-350-32-1.60-10
14	10	3802-350-32-1.60-14
6	10	3802-400-25-1.25-6
10	10	3802-400-25-1.25-10
14	10	3802-400-25-1.25-14
4	10	3802-400-32-1.60-4
6	10	3802-400-32-1.60-6
8	10	3802-400-32-1.60-8
10	10	3802-400-32-1.60-10
14	10	3802-400-32-1.60-14
4	10	3802-400-38-2.00-4
6	10	3802-400-38-2.00-6
10	10	3802-400-38-2.00-10

BAHCO



6	10	3802-425-32-1.60-6
10	10	3802-425-32-1.60-10
4	10	3802-450-32-1.60-4
6	10	3802-450-32-1.60-6
10	10	3802-450-32-1.60-10
14	10	3802-450-32-1.60-14
4	10	3802-450-38-2.00-4
6	10	3802-450-38-2.00-6
8	10	3802-450-38-2.00-8
10	10	3802-450-38-2.00-10
8	10	3802-475-38-2.00-8
4	10	3802-500-38-2.00-4
6	10	3802-500-38-2.00-6
8	10	3802-500-38-2.00-8
10	10	3802-500-38-2.00-10
10	10	3802-500-45-2.25-10
4	10	3802-500-50-2.50-4
6	10	3802-500-50-2.50-6
6	10	3802-525-38-2.00-6
8	10	3802-525-38-2.00-8
10	10	3802-525-38-2.00-10
6	10	3802-550-38-2.00-6
4	10	3802-550-50-2.50-4
6	10	3802-550-50-2.50-6
8	5	3802-550-50-2.50-8
10	10	3802-550-50-2.50-10
4	10	3802-575-50-2.50-4
6	10	3802-575-50-2.50-6
4	10	3802-600-50-2.50-4
6	10	3802-600-50-2.50-6
8	10	3802-600-50-2.50-8
4	5	3802-650-50-2.50-4
6	5	3802-650-50-2.50-6
3	5	3802-700-50-2.50-3
4	5	3802-700-50-2.50-4
6	5	3802-700-50-2.50-6
4	5	3802-750-50-2.50-4
6	5	3802-750-50-2.50-6

Hoja de sierra para máquinas KASTO HSS Acero rápido



3802 KA



4	10	3802-450-38-2.00-4-KA
6	10	3802-450-38-2.00-6-KA
8	10	3802-450-38-2.00-8-KA
10	10	3802-450-38-2.00-10-KA
4	10	3802-500-50-2.50-4-KA
6	10	3802-500-50-2.50-6-KA
4	10	3802-550-50-2.50-4-KA
8	10	3802-550-50-2.50-8-KA
3	10	3802-575-50-2.50-3-KA
4	10	3802-575-50-2.50-4-KA
6	10	3802-575-50-2.50-6-KA
4	5	3802-650-50-2.50-4-KA
6	5	3802-650-50-2.50-6-KA
2	5	3802-700-50-2.50-2-KA
4	5	3802-700-50-2.50-4-KA
6	5	3802-700-50-2.50-6-KA



Limas



LIMAS DE MECÁNICO

Lima plana paralela, embalaje industrial, sin mango



1-100...-0

100	1	10	1-100-04-1-0
100	2	10	1-100-04-2-0
100	3	10	1-100-04-3-0
150	1	10	1-100-06-1-0
150	2	10	1-100-06-2-0
150	3	10	1-100-06-3-0
200	1	10	1-100-08-1-0
200	2	10	1-100-08-2-0
200	3	10	1-100-08-3-0
250	1	10	1-100-10-1-0
250	2	10	1-100-10-2-0
250	3	10	1-100-10-3-0
300	1	5	1-100-12-1-0
300	2	5	1-100-12-2-0
300	3	5	1-100-12-3-0
350	1	5	1-100-14-1-0
350	2	5	1-100-14-2-0

Tipo de picado: 1 = Basto, 2 = Entrefino, 3 = Fino

Lima paralela con mango
Embalaje unitario

ergo



1-100...-2

100	1	5	1-100-04-1-2
100	2	5	1-100-04-2-2
150	1	5	1-100-06-1-2
150	2	5	1-100-06-2-2
150	3	5	1-100-06-3-2
200	1	5	1-100-08-1-2
200	2	5	1-100-08-2-2
200	3	5	1-100-08-3-2
250	1	5	1-100-10-1-2
250	2	5	1-100-10-2-2
250	3	5	1-100-10-3-2
300	1	5	1-100-12-1-2
300	2	5	1-100-12-2-2
300	3	5	1-100-12-3-2

Tipo de picado: 1 = Basto, 2 = Entrefino, 3 = Fino

Lima plana paralela, delgada
Embalaje industrial sin mango



1-102

150	2	10	1-102-06-2-0
150	3	10	1-102-06-3-0
200	1	10	1-102-08-1-0
200	2	10	1-102-08-2-0
200	3	10	1-102-08-3-0

Lima para torear
Embalaje industrial sin mango



1-104

250	2	10	1-104-10-2-0
250	3	10	1-104-10-3-0
300	2	5	1-104-12-2-0
300	3	5	1-104-12-3-0
350	3	5	1-104-14-3-0

Tipo de picado: 2 = Entrefino, 3 = Fino

Lima plana paralela "Oberg Cut"
Embalaje industrial sin mango



1-106...-0

200	1	10	1-106-08-1-0
250	1	10	1-106-10-1-0
300	1	5	1-106-12-1-0

Limado Oberg
Embalaje unitario

ergo



1-106...-2

200	1	5	1-106-08-1-2
250	1	5	1-106-10-1-2
300	1	5	1-106-12-1-2

Lima plana
Embalaje industrial sin mango



1-110...-0

100	1	10	1-110-04-1-0
100	2	10	1-110-04-2-0
100	2	10	1-110-04-3-0
150	1	10	1-110-06-1-0
150	2	10	1-110-06-2-0
150	3	10	1-110-06-3-0
200	1	10	1-110-08-1-0
200	2	10	1-110-08-2-0
200	2	10	1-110-08-3-0
250	1	10	1-110-10-1-0
250	2	10	1-110-10-2-0
250	3	10	1-110-10-3-0
300	1	5	1-110-12-1-0
300	2	5	1-110-12-2-0
300	3	5	1-110-12-3-0
350	1	5	1-110-14-1-0

Tipo de picado: 1 = Basto, 2 = Entrefino, 3 = Fino

Lima plana
Embalaje unitario

ergo



1-110...-2

150	1	5	1-110-06-1-2
150	2	5	1-110-06-2-2
150	3	5	1-110-06-3-2
200	1	5	1-110-08-1-2
200	2	5	1-110-08-2-2
200	3	5	1-110-08-3-2

250	1		5	1-110-10-1-2
250	2		5	1-110-10-2-2
250	3		5	1-110-10-3-2
300	1		5	1-110-12-1-2
300	2		5	1-110-12-2-2
300	3		5	1-110-12-3-2

Tipo de picado: 1 = Basto, 2 = Entrefino, 3 = Fino

Lima plana, punta delgada
Embalaje industrial sin mango



1-111...-0

100	1		10	1-111-04-1-0
100	2		10	1-111-04-2-0
100	3		10	1-111-04-3-0
150	1		10	1-111-06-1-0
150	2		10	1-111-06-2-0
150	3		10	1-111-06-3-0
200	1		10	1-111-08-1-0
200	2		10	1-111-08-2-0

Tipo de picado: 1 = Basto, 2 = Entrefino, 3 = Fino

Lima plana, punta delgada
Embalaje unitario

ergo®



1-111...-2

150	2		5	1-111-06-2-2

Lima de contacto



1-115

110	3		10	1-115-11-3-1

Lima universal, 2 cantos planos (tipo USA)
Embalaje industrial sin mango. Tipo picado Basto



1-143...-0

100	1		10	1-143-04-1-0
150	1		10	1-143-06-1-0
200	1		10	1-143-08-1-0
250	1		10	1-143-10-1-0
300	1		5	1-143-12-1-0

Lima 2 cantos planos
Embalaje individual. Tipo picado Basto

ergo®



1-143...-2

150	1		5	1-143-06-1-2
200	1		5	1-143-08-1-2
250	1		5	1-143-10-1-2
300	1		5	1-143-12-1-2

Lima diagonal
Tipo de picado entrefino

ergo®



1-320...-2

200	2		5	1-320-08-2-2
250	2		5	1-320-10-2-2
300	2		5	1-320-12-2-2

Lima diagonal
Embalaje industrial sin mango



1-320...-0

200	2		10	1-320-08-2-0
250	2		10	1-320-10-2-0
300	2		5	1-320-12-2-0

Lima triangular
Embalaje industrial sin mango



1-170...-0

100	1		10	1-170-04-1-0
100	2		10	1-170-04-2-0
100	3		10	1-170-04-3-0
150	1		10	1-170-06-1-0
150	2		10	1-170-06-2-0
150	3		10	1-170-06-3-0
200	1		10	1-170-08-1-0
200	2		10	1-170-08-2-0
200	3		10	1-170-08-3-0
250	1		10	1-170-10-1-0
250	2		10	1-170-10-2-0
250	3		10	1-170-10-3-0
300	1		5	1-170-12-1-0
300	2		5	1-170-12-2-0

Tipo de picado: 1 = Basto, 2 = Entrefino, 3 = Fino

Lima triangular
Embalaje individual con cartón

ergo®



1-170...-2

100	2		5	1-170-04-2-2
150	1		5	1-170-06-1-2
150	2		5	1-170-06-2-2
150	3		5	1-170-06-3-2
200	1		5	1-170-08-1-2
200	2		5	1-170-08-2-2
200	3		5	1-170-08-3-2
250	1		5	1-170-10-1-2
250	2		5	1-170-10-2-2
250	3		5	1-170-10-3-2

Tipo de picado: 1 = Basto, 2 = Entrefino, 3 = Fino



Lima cuadrada
Embalaje industrial sin mango



1-160...-0

100	1	10	10	1-160-04-1-0
100	2	10	10	1-160-04-2-0
100	3	10	10	1-160-04-3-0
150	1	10	10	1-160-06-1-0
150	2	10	10	1-160-06-2-0
150	3	10	10	1-160-06-3-0
200	1	10	10	1-160-08-1-0
200	2	10	10	1-160-08-2-0
200	3	10	10	1-160-08-3-0
250	1	10	10	1-160-10-1-0
250	2	10	10	1-160-10-2-0
250	3	10	10	1-160-10-3-0
300	1	5	5	1-160-12-1-0
300	2	5	5	1-160-12-2-0
300	3	5	5	1-160-12-3-0

Tipo de picado: 1 = Basto, 2 = Entrefino, 3 = Fino

Lima cuadrada
Embalaje industrial sin mango



1-160...-2

100	1	5	5	1-160-04-1-2
100	2	5	5	1-160-04-2-2
150	1	5	5	1-160-06-1-2
150	2	5	5	1-160-06-2-2
150	3	5	5	1-160-06-3-2
200	1	5	5	1-160-08-1-2
200	2	5	5	1-160-08-2-2
200	3	5	5	1-160-08-3-2
250	1	5	5	1-160-10-1-2
250	2	5	5	1-160-10-2-2
250	3	5	5	1-160-10-3-2
300	1	5	5	1-160-12-1-2
300	2	5	5	1-160-12-2-2
300	3	5	5	1-160-12-3-2

Tipo de picado: 1 = Basto, 2 = Entrefino, 3 = Fino

Lima media caña
Embalaje industrial sin mango



1-210...-0

100	1	10	10	1-210-04-1-0
100	2	10	10	1-210-04-2-0
100	3	10	10	1-210-04-3-0

150	1	10	10	1-210-06-1-0
150	2	10	10	1-210-06-2-0
150	3	10	10	1-210-06-3-0
200	1	10	10	1-210-08-1-0
200	2	10	10	1-210-08-2-0
200	3	10	10	1-210-08-3-0
250	1	10	10	1-210-10-1-0
250	2	10	10	1-210-10-2-0
250	3	10	10	1-210-10-3-0
300	1	5	5	1-210-12-1-0
300	2	5	5	1-210-12-2-0
300	3	5	5	1-210-12-3-0
350	1	5	5	1-210-14-1-0

Tipo de picado: 1 = Basto, 2 = Entrefino, 3 = Fino

Lima de media caña
Embalaje individual con cartón



1-210...-2

100	1	5	5	1-210-04-1-2
100	2	5	5	1-210-04-2-2
150	1	5	5	1-210-06-1-2
150	2	5	5	1-210-06-2-2
150	3	5	5	1-210-06-3-2
200	1	5	5	1-210-08-1-2
200	2	5	5	1-210-08-2-2
200	3	5	5	1-210-08-3-2
250	1	5	5	1-210-10-1-2
250	2	5	5	1-210-10-2-2
250	3	5	5	1-210-10-3-2
300	1	5	5	1-210-12-1-2
300	2	5	5	1-210-12-2-2
300	3	5	5	1-210-12-3-2

Tipo de picado: 1 = Basto, 2 = Entrefino, 3 = Fino

Juego 6 limas de mecánico, picado fino
Mango ERGO™



1-476

100	3	1	1	1-476-04-3-2

Tipo de picado: 3 = Fino

Juego de 3 limas de mecánico ERGO™
Tipo picado Entrefino



1-473

150	2	5	5	1-473-06-2-2

1-230-06-2-2

1-210-06-2-2

1-100-06-2-2

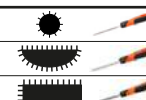

Juego de 3 limas de mecánico ERGO™
Tipo picado Entrefino



1-473-08-2-2

200	2	5	5	1-473-08-2-2

1-230-08-2-2

1-210-08-2-2

1-100-08-2-2

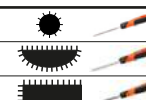

Juego de 3 limas de mecánico ERGO™
Tipo picado Entrefino



1-473-10-2-2

250	2	5	5	1-473-10-2-2

1-230-10-2-2		
1-210-10-2-2		
1-100-10-2-2		

Juego de 5 limas de mecánico ERGO™
Tipo picado entrefino



1-477

			5	1-477-08-2-2
--	--	--	---	--------------

1-100-08-2-2		
1-210-08-2-2		
6-343-08-2-2		
1-230-08-2-2		
1-170-08-2-2		

Juego de 5 limas de mecánico ERGO™
Tipo picado entrefino



1-477-10-2-2

			5	1-477-10-2-2
--	--	--	---	--------------

1-100-10-2-2		
1-210-10-2-2		
6-343-10-2-2		
1-230-10-2-2		
1-170-10-2-2		

Juego de 5 limas de mecánico ERGO™
Tipo picado Basto y Entrefino



1-478

			5	1-478-08-1-2
--	--	--	---	--------------

1-210-08-1-2		
1-230-08-1-2		
1-100-08-1-2, 1-100-08-2-2		
1-160-08-1-2		

Juego de 5 limas de mecánico ERGO™
Tipo picado Basto y Entrefino



1-478-10-1-2

			5	1-478-10-1-2
--	--	--	---	--------------

1-210-10-1-2		
1-230-10-1-2		
1-100-10-1-2, 1-100-10-2-2		
1-160-10-1-2		

Juego de 5 limas de mecánico ERGO™
Tipo picado Basto



1-479

			5	1-479-08-1-2
--	--	--	---	--------------

4-138-08-1-2		
1-210-08-1-2		
6-343-08-2-2		
1-230-08-1-2		
1-100-08-1-2		

Juego de 5 limas de mecánico ERGO™
Tipo picado Entrefino



1-479-08-2-2

			5	1-479-08-2-2
--	--	--	---	--------------

4-138-08-1-2		
1-210-08-2-2		
6-343-08-2-2		
1-230-08-2-2		
1-100-08-2-2		

Lima redonda
Embalaje industrial sin mango



1-230...-0

100	1	10	1-230-04-1-0
100	2	10	1-230-04-2-0
100	3	10	1-230-04-3-0
150	1	10	1-230-06-1-0
150	2	10	1-230-06-2-0
150	3	10	1-230-06-3-0
200	1	10	1-230-08-1-0
200	2	10	1-230-08-2-0
200	3	10	1-230-08-3-0
250	1	10	1-230-10-1-0
250	2	10	1-230-10-2-0
250	3	10	1-230-10-3-0
300	1	5	1-230-12-1-0
300	2	5	1-230-12-2-0
300	3	5	1-230-12-3-0

Tipo de picado: 1 = Basto, 2 = Entrefino, 3 = Fino



Lima redonda con mango
Embalaje individual con cartón



1-230...-2

100	1		5	1-230-04-1-2
100	2		5	1-230-04-2-2
150	1		5	1-230-06-1-2
150	2		5	1-230-06-2-2
150	3		5	1-230-06-3-2
200	1		5	1-230-08-1-2
200	2		5	1-230-08-2-2
200	3		5	1-230-08-3-2
250	1		5	1-230-10-1-2
250	2		5	1-230-10-2-2
250	3		5	1-230-10-3-2
300	1		5	1-230-12-1-2
300	2		5	1-230-12-2-2
300	3		5	1-230-12-3-2

Tipo de picado: 1-basto/ 2-entrefino/ 3-fino

LIMAS DE AGUJA

Lima plana paralela
Embalaje industrial sin mango



2-300

140	0		10	2-300-14-0-0
140	2		10	2-300-14-2-0
140	4		10	2-300-14-4-0
160	0		10	2-300-16-0-0
160	1		10	2-300-16-1-0
160	2		10	2-300-16-2-0
160	4		10	2-300-16-4-0
180	0		10	2-300-18-0-0
180	2		10	2-300-18-2-0

Tipo de picado: 0 = Basto, 1 = Entrefino, 2 = Fino, 4 = Super-fino

Lima plana
Embalaje industrial sin mango



2-301

140	0		10	2-301-14-0-0
140	2		10	2-301-14-2-0

160	0		10	2-301-16-0-0
160	1		10	2-301-16-1-0
160	2		10	2-301-16-2-0

Tipo de picado: 0 = Basto, 1 = Entrefino, 2 = Fino, 4 = Super-fino

Lima triangular
Embalaje industrial sin mango



2-302

140	0		10	2-302-14-0-0
140	2		10	2-302-14-2-0
140	4		10	2-302-14-4-0
160	0		10	2-302-16-0-0
160	1		10	2-302-16-1-0
160	2		10	2-302-16-2-0
160	4		10	2-302-16-4-0
180	0		10	2-302-18-0-0
180	2		10	2-302-18-2-0

Tipo de picado: 0 = Basto, 1 = Entrefino, 2 = Fino, 4 = Super-fino

Lima cuadrada
Embalaje industrial sin mango



2-303

140	2		10	2-303-14-2-0
160	0		10	2-303-16-0-0
160	1		10	2-303-16-1-0
160	2		10	2-303-16-2-0
160	4		10	2-303-16-4-0
180	0		10	2-303-18-0-0
180	2		10	2-303-18-2-0

Tipo de picado: 0 = Basto, 1 = Entrefino, 2 = Fino, 4 = Super-fino

Lima media caña
Embalaje industrial sin mango



2-304

140	0		10	2-304-14-0-0
140	2		10	2-304-14-2-0

140	4		10	2-304-14-4-0
160	0		10	2-304-16-0-0
160	1		10	2-304-16-1-0
160	2		10	2-304-16-2-0
160	4		10	2-304-16-4-0
180	0		10	2-304-18-0-0
180	2		10	2-304-18-2-0

Tipo de picado: 0 = Basto, 1 = Entrefino, 2 = Fino, 4 = Super-fino

Lima marking
Embalaje industrial sin mango



2-313

160	0		10	2-313-16-0-0

Tipo de picado: 0 = Basto, 1 = Entrefino, 2 = Fino, 4 = Super-fino

Lima ovalada
Embalaje industrial sin mango



2-305

160	1		10	2-305-16-1-0
160	2		10	2-305-16-2-0

Tipo de picado: 0 = Basto, 1 = Entrefino, 2 = Fino, 4 = Super-fino

Lima semi-ovalada
Embalaje industrial sin mango



2-306

160	1		10	2-306-16-1-0
160	2		10	2-306-16-2-0

Tipo de picado: 0 = Basto, 1 = Entrefino, 2 = Fino, 4 = Super-fino

Lima redonda
Embalaje industrial sin mango



2-307

140	160	180	0	1	2	4
10	10	10	2-307-14-0-0	2-307-14-2-0	2-307-14-4-0	2-307-16-0-0
10	10	10	2-307-16-1-0	2-307-16-2-0	2-307-16-4-0	2-307-18-0-0
10	10	10	2-307-18-2-0			

Tipo de picado: 0 = Basto, 1 = Entrefino, 2 = Fino, 4 = Super-fino

Lima cuchillo
Embalaje industrial sin mango



2-308

140	160	180	2	0	1	4
10	10	10	2-308-14-2-0	2-308-16-0-0	2-308-16-1-0	2-308-16-2-0

Tipo de picado: 0 = Basto, 1 = Entrefino, 2 = Fino, 4 = Super-fino

Lima Barrette
Embalaje industrial sin mango



2-309

160	160	2	4
10	10	2-309-16-2-0	2-309-16-4-0

Tipo de picado: 0 = Basto, 1 = Entrefino, 2 = Fino, 4 = Super-fino

Juego de 6 limas de aguja + 1 mango
Tipo de picado: 0=Basto



2-470

140	0	10
2-470-14-0-0		

9-488-02-10	2-304-14-0-0	2-300-14-0-0	2-303-14-0-0	2-302-14-0-0	2-301-14-0-0	2-307-14-0-0

Juego de 6 limas de aguja + 1 mango
Tipo de picado: 2 = fino



2-470-14-2-0

140	2	10
2-470-14-2-0		

9-488-02-10	2-304-14-2-0	2-300-14-2-0	2-303-14-2-0	2-302-14-2-0	2-301-14-2-0	2-307-14-2-0

Juego de 6 limas de aguja + 1 mango
Tipo de picado: 4=Superfino



2-470-14-4-0

140	4	10
2-470-14-4-0		

9-488-02-10	2-304-14-4-0	2-300-14-4-0	2-303-14-4-0	2-302-14-4-0	2-301-14-4-0	2-307-14-4-0

Juego de 6 limas de aguja + 1 mango
Tipo de picado: 1=Entrefino



2-470-16-1-0

160	1	10
2-470-16-1-0		

9-488-02-10	2-304-16-1-0	2-300-16-1-0	2-303-16-1-0	2-302-16-1-0	2-301-16-1-0	2-307-16-1-0



Juego de 6 limas de aguja + 1 mango
Tipo de picado: 2=Finó



2-470-16-2-0



9-488-02-10	
2-304-16-2-0	
2-300-16-2-0	
2-303-16-2-0	
2-302-16-2-0	
2-301-16-2-0	
2-307-16-2-0	

Juego de 9 limas de aguja + 1 mango
Tipo picado entrefino



2-471



9-488-02-10	
2-303-16-1-0	
2-304-16-1-0	
2-302-16-1-0	
2-300-16-1-0	
2-308-16-1-0	
2-301-16-1-0	
2-306-16-1-0	
2-305-16-1-0	
2-307-16-1-0	

Juego de 12 limas de aguja + 1 mango
Tipo picado basto



2-472



2-303-14-0-0	
2-300-14-0-0	
2-301-14-0-0	
2-304-14-0-0	
2-302-14-0-0	
2-313-14-0-0	
2-307-14-0-0	
2-309-14-0-0, 2-306-14-0-0	
9-488-02-10	

Juego de 12 limas de aguja
Tipo de picado fino



2-472-14-2-0



2-303-14-2-0	
2-300-14-2-0	
2-301-14-2-0	
2-304-14-2-0	
2-302-14-2-0	
2-313-14-2-0	
2-307-14-2-0	
2-306-14-2-0	
2-308-14-2-0	
9-488-02-10	

Juego de 12 limas de aguja
Tipo de picado basto



2-472-16-0-0



2-303-16-0-0	
2-300-16-0-0	
2-301-16-0-0	
2-304-16-0-0	
2-302-16-0-0	
2-313-16-0-0	
2-307-16-0-0	
2-306-16-0-0	
2-308-16-0-0	
9-488-02-10	

Juego de 12 limas de aguja
Picado entrefino



2-472-16-1-0



2-300-16-1-0	
2-301-16-1-0	
2-302-16-1-0	
2-303-16-1-0	
2-304-16-1-0	
2-306-16-1-0	
2-307-16-1-0	
2-308-16-1-0	
2-309-16-2-0	
2-313-16-2-0	
9-488-02-10	

Juego de 12 limas de aguja
Picado fino



2-472-16-2-0

160	2	5	2-472-16-2-0

2-303-16-2-0		
2-300-16-2-0		
2-301-16-2-0		
2-304-16-2-0		
2-302-16-2-0		
2-313-16-2-0		
2-307-16-2-0		
2-309-16-2-0		
2-306-16-2-0		
2-308-16-2-0		
9-488-02-10		

LIMAS DE DIAMANTE

Limas de aguja de diamante



2-300-D - 2-304-D

140	10	2-300-14-D-1P
160	10	2-300-16-D-1P
140	1	2-301-14-D-1P
140	10	2-302-14-D-1P
160	10	2-302-16-D-1P
140	10	2-303-14-D-1P
160	1	2-303-16-D-1P
140	10	2-304-14-D-1P
160	10	2-304-16-D-1P

Limas de precisión de diamante



5-600-D - 5-670-D

215	10	5-600-21-D-1P
215	1	5-610-21-D-1P
215	1	5-630-21-D-1P
215	1	5-670-21-D-1P

Limas de aguja de diamante



2-306-D - 2-308-D

140	1	2-306-14-D-1P
140	10	2-307-14-D-1P
160	10	2-307-16-D-1P
140	1	2-308-14-D-1P

LIMAS CON DIENTES FRESADOS

Hoja plana Pansar®
Embalaje industrial sin mango



3-330

300	1	5	3-330-12-1-0
300	2	5	3-330-12-2-0
350	1	5	3-330-14-1-0
350	2	5	3-330-14-2-0

Hoja 12" para portafilas 9-462 y 9-463, hoja 14" para portafilas 9-462

Hoja de media caña Pansar®
Embalaje industrial sin mango



3-331

350	1	5	3-331-14-1-0

Tipo de picado: 1 = Basto, 2 = Entrefino

Lima patrón
Embalaje industrial con mango



FM10

300	4 & 5	5	FM12
250	4 & 5	5	FM10

Un lado con picado cizalla, por el otro dentado curvado

Lima patrón, media caña
Embalaje industrial con mango



HRFM10

250	5	5	HRFM10



LIMAS PARA AFILADO

Lima plana paralela
Embalaje industrial sin mango. Tipo picado Basto



4-138...-0

Longitud	Picado	Embalaje	Artículo
150	1	10	4-138-06-1-0
200	1	10	4-138-08-1-0
250	1	10	4-138-10-1-0
300	1	5	4-138-12-1-0

Lima plana paralela
Embalaje industrial sin mango. Tipo picado Basto

ergo®



4-138...-2

Longitud	Picado	Embalaje	Artículo
150	1	5	4-138-06-1-2
200	1	5	4-138-08-1-2
250	1	5	4-138-10-1-2
300	1	5	4-138-12-1-2

Lima plana paralela
Embalaje industrial sin mango. Tipo picado Basto



4-140...-0

Longitud	Picado	Embalaje	Artículo
150	1	10	4-140-06-1-0
200	1	10	4-140-08-1-0
250	1	10	4-140-10-1-0

Lima plana paralela
Embalaje industrial sin mango. Tipo picado Basto

ergo®



4-140...-2

Longitud	Picado	Embalaje	Artículo
200	1	5	4-140-08-1-2
250	1	5	4-140-10-1-2

Lima plana paralela
Embalaje industrial sin mango Tipo picado Basto



4-142

Longitud	Picado	Embalaje	Artículo
150	1	10	4-142-06-1-0
200	1	10	4-142-08-1-0
250	1	10	4-142-10-1-0

Lima plana paralela
Embalaje industrial sin mango. Tipo picado Entrefino



4-144...-0

Longitud	Picado	Embalaje	Artículo
200	2	10	4-144-08-2-0

Lima plana paralela
Embalaje individual en cartón. Tipo picado Entrefino

ergo®



4-144...-2

Longitud	Picado	Embalaje	Artículo
200	2	5	4-144-08-2-2

Lima de bricolaje para madera
Embalaje individual con cartón

ergo®



4-152

Longitud	Picado	Embalaje	Artículo
200	2 & 2	5	4-152-08-2-2

Un lado con picado doble basto, el otro lado picado sencillo entrefino

Lima de bricolaje para metal, embalaje individual
Mango ERGO™

ergo®



4-153

Longitud	Picado	Embalaje	Artículo
200	1 & 1	5	4-153-08-1-2

Un lado con picado doble basto, el otro lado picado sencillo entrefino

Juego de 2 limas de bricolaje 4-152 + 4-153
Embalaje industrial con mango

ergo®



4-154

Longitud	Picado	Embalaje	Artículo
200	1 & 2	10	4-154-08-2-2

Lima para herramientas agrícolas
Embalaje industrial sin mango. Tipo picado Entrefino



4-155

Longitud	Picado	Embalaje	Artículo
200	2	10	4-155-08-2-0
250	2	5	4-155-10-2-0

Lima triangular para afilado
Embalaje industrial sin mango. Tipo picado Entrefino



4-183...-0

Length	Quantity	Code
100	2	10 4-183-04-2-0
112	2	10 4-183-45-2-0
125	2	10 4-183-05-2-0
150	2	10 4-183-06-2-0
175	2	10 4-183-07-2-0
200	2	10 4-183-08-2-0
250	2	10 4-183-10-2-0

Lima triangular para afilado
Embalaje individual en cartón. Tipo picado Entrefino



4-183...-2

Length	Quantity	Code
100	2	5 4-183-04-2-2
125	2	5 4-183-05-2-2
150	2	5 4-183-06-2-2
175	2	5 4-183-07-2-2
200	2	5 4-183-08-2-2

Lima triangular delgada
Embalaje industrial sin mango. Tipo picado Entrefino



4-186...-0

Length	Quantity	Code
100	2	10 4-186-04-2-0
112	2	10 4-186-45-2-0
125	2	10 4-186-05-2-0
150	2	10 4-186-06-2-0
175	2	10 4-186-07-2-0
200	2	10 4-186-08-2-0

Lima triangular delgada
Embalaje individual en cartón. Tipo picado Entrefino



4-186...-2

Length	Quantity	Code
100	2	5 4-186-04-2-2
125	2	5 4-186-05-2-2
150	2	5 4-186-06-2-2

Lima triangular extra-delgada
Embalaje industrial sin mango. Tipo picado Entrefino



4-187...-0

Length	Quantity	Code
100	2	10 4-187-04-2-0
112	2	10 4-187-45-2-0
125	2	10 4-187-05-2-0
150	2	10 4-187-06-2-0
175	2	10 4-187-07-2-0

Lima triangular extra delgada
Embalaje individual en cartón. Tipo picado Entrefino



4-187...-2

Length	Quantity	Code
125	2	5 4-187-05-2-2
150	2	5 4-187-06-2-2

Lima triangular super delgada
Embalaje industrial sin mango. Tipo picado Entrefino



4-188...-0

Length	Quantity	Code
125	2	10 4-188-05-2-0
150	2	10 4-188-06-2-0

Lima triangular super delgada
Embalaje individual en cartón. Tipo picado Entrefino



4-188...-2

Length	Quantity	Code
125	2	5 4-188-05-2-2

Lima triangular para sierras - 2 puntas
Embalaje industrial con mango. Tipo picado Entrefino



4-190...-0

Length	Quantity	Code
150	2	10 4-190-06-2-0
175	2	10 4-190-07-2-0
200	2	10 4-190-08-2-0



Lima triangular para sierras - 2 puntas
Embalaje individual en cartón. Tipo picado Entrefino.

ergo®



4-190...-2

Length	Quantity	Quantity	Code
150	2	5	4-190-06-2-2
175	2	5	4-190-07-2-2
200	2	5	4-190-08-2-2

Lima triangular para sierra de cinta
Embalaje industrial sin mango. Tipo picado Entrefino



4-192...-0

Length	Quantity	Quantity	Code
150	2	10	4-192-06-2-0
175	2	10	4-192-07-2-0
200	2	10	4-192-08-2-0

Lima triangular para sierra de cinta
Embalaje individual en cartón. Tipo picado Entrefino

ergo®



4-192...-2

Length	Quantity	Quantity	Code
150	2	5	4-192-06-2-2
200	2	5	4-192-08-2-2

Limas para sierra de cinta
Embalaje industrial sin mango. Tipo picado Entrefino



4-202 - 4-204

Length	Quantity	Quantity	Code
216	2	10	4-202-85-2-0
216	2	10	4-203-85-2-0
216	2	10	4-204-85-2-0

Lima rómbica Wasa™
Embalaje industrial sin mango. Tipo picado Fino



4-272...-0

Length	Quantity	Quantity	Code
150	3	10	4-272-06-3-0

Lima rómbica Wasa™
Embalaje individual, Mango ERGO™. Tipo picado Fino

ergo®



4-272...-2

Length	Quantity	Quantity	Code
125	3	5	4-272-05-3-2
150	3	5	4-272-06-3-2

Lima para cadena de motosierra, plana
Embalaje individual con cartón

ergo®



166-2

Length	Quantity	Quantity	Code
150	3	5	166-6-16-2.5-2

Lima para cadena de motosierra, plana
Embalaje industrial, sin mango



166/167-12

Length	Quantity	Quantity	Code
150	3	12	166-6-16-2.5-12
200	1	12	167-8-21-3.2-12

Lima para cadena de motosierra
Embalaje individual



168 - 1P

Length	Quantity	Quantity	Code
150	3.2	12	168-6-3.2-1P
150	3.5	12	168-6-3.5-1P
200	4.0	12	168-8-4.0-1P
200	4.5	12	168-8-4.5-1P
200	4.8	12	168-8-4.8-1P
200	5.2	12	168-8-5.2-1P
200	5.5	12	168-8-5.5-1P
200	6.3	12	168-8-6.3-1P

Lima para cadena de motosierra
3 limas por embalaje



168 - 3P

Length	Quantity	Quantity	Code
150	3.2	12	168-6-3.2-3P
150	3.5	12	168-6-3.5-3P
200	4.0	12	168-8-4.0-3P
200	4.5	12	168-8-4.5-3P
200	4.8	12	168-8-4.8-3P
200	5.2	12	168-8-5.2-3P
200	5.5	12	168-8-5.5-3P
200	6.3	12	168-8-6.3-3P

Lima para cadena de motosierra, caja de 6 limas



168-8

Length	Width	Quantity	Part Number
200	4.0	6	168-8-4.0-6
200	4.5	6	168-8-4.5-6
200	4.8	6	168-8-4.8-6
200	5.2	6	168-8-5.2-6
200	5.5	6	168-8-5.5-6

Juego de limas para cadenas de motosierra
Pack de dos limas de cadena redonas y una plana de 6"

ergo®



168-C

Length	Width	Quantity	Part Number
200	4.0	10	168-COMBI-4.0
200	4.5	10	168-COMBI-4.5
200	4.8	10	168-COMBI-4.8
200	5.5	10	168-COMBI-5.5

Juego de limas para cadenas de motosierra con guía de limado. Pack de dos limas de cadena redonas, una plana de 6" y una lima de guiado

ergo®



168-C-G

Length	Width	Quantity	Part Number
200	4.0	10	168-COMBI-4.0-6922
200	4.8	10	168-COMBI-4.8-6920
200	5.5	10	168-COMBI-5.5-6924

ESCOFINAS

Escofina media caña
Embalaje industrial sin mango



6-342...-0

Length	Width	Quantity	Part Number
150	2	10	6-342-06-2-0
200	1	10	6-342-08-1-0
200	2	10	6-342-08-2-0
250	1	10	6-342-10-1-0
250	2	10	6-342-10-2-0

Tipo de picado: 1 = Basto, 2 = Entrefino

Escofina media caña
Embalaje individual con cartón

ergo®



6-342...-2

Length	Width	Quantity	Part Number
150	2	5	6-342-06-2-2
200	1	5	6-342-08-1-2
200	2	5	6-342-08-2-2
250	1	5	6-342-10-1-2
250	2	5	6-342-10-2-2

Tipo de picado: 1 = Basto, 2 = Entrefino

Escofina media caña, lengua de vaca
Embalaje industrial sin mango



6-343...-0

Length	Width	Quantity	Part Number
200	2	10	6-343-08-2-0
200	3	10	6-343-08-3-0
250	2	10	6-343-10-2-0
250	3	10	6-343-10-3-0

Tipo de picado: 1 = Basto, 2 = Entrefino

Escofina media caña, lengua de vaca
Embalaje individual con cartón

ergo®



6-343...-2

Length	Width	Quantity	Part Number
200	2	5	6-343-08-2-2
250	2	5	6-343-10-2-2

Tipo de picado: 1 = Basto, 2 = Entrefino

Escofina plana paralela
Embalaje industrial sin mango



6-344...-0

Length	Width	Quantity	Part Number
200	2	10	6-344-08-2-0
250	2	10	6-344-10-2-0

Tipo de picado: 1 = Basto, 2 = Entrefino

Escofina plana paralela
Embalaje individual con cartón

ergo®



6-344...-2

Length	Width	Quantity	Part Number
200	2	5	6-344-08-2-2
250	2	5	6-344-10-2-2

Tipo de picado: 1-basto/ 2-entrefino

Escofina redonda
Embalaje industrial sin mango



6-345...-0

Length	Width	Quantity	Part Number
200	2	10	6-345-08-2-0
250	2	10	6-345-10-2-0

Tipo de picado: 1 = Basto, 2 = Entrefino



Escofina redonda
Embalaje individual con cartón

ergo®



6-345...-2



200	1	5	6-345-08-1-2
200	2	5	6-345-08-2-2
250	1	5	6-345-10-1-2

Tipo de picado: 1 = Basto, 2 = Entrefino

Juego de 3 escofinas ERGO™
Tipo picado Entrefino

ergo®



6-470



200	2	5	6-470-08-2-2
-----	---	---	--------------

6-345-08-2-2

6-342-08-2-2

4-152-08-2-2

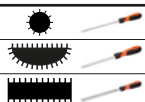

ACCESORIOS

Mango universal para limas de aguja



9-488-02



5	10	9-488-02-10
---	----	-------------

Porta limas Pansar®



9-462

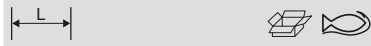

350	5	9-462-14-0-0
-----	---	--------------

Porta limas aluminio para hojas planas Pansar®
Mango giratorio



9-463

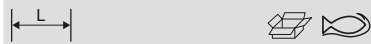

300 & 350	1	9-463-14-0-0
-----------	---	--------------

Cepillo para limas
Alambre de acero + cerdas



9-467

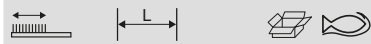

130 mm	260	1	9-467-00-0-0
--------	-----	---	--------------

Cepillo para limas
Alambre de acero



9-469



110 mm	240	1	9-469-00-0-0
--------	-----	---	--------------

Mango bimaterial ERGO™ para limas pequeñas

ergo®



9-484...10



3.2	3.2	10	9-484-3.2-10
5.2	5.2	10	9-484-5.2-10

Mango bimaterial ERGO™ para limas pequeñas

ergo®



9-484...1P



3.2	3.2	10	9-484-3.2-1P
5.2	5.2	10	9-484-5.2-1P

Mango bimaterial ERGO™ para limas planas

ergo®



9-485...10



4	4 mm	10	9-485-04-10
5	5 mm	10	9-485-05-10
6	6	10	9-485-06-10
9	9	10	9-485-09-10
13	13	10	9-485-13-10

Mango bimaterial ERGO™ para limas planas



9-485...1P

File Size	File Width	Quantity	Part No.
4	4 mm	10	9-485-04-1P
5	5 mm	10	9-485-05-1P
6	6	20	9-485-06-1P
9	9	20	9-485-09-1P
13	13	1	9-485-13-1P

Para limas planas, punta sin mango y semiesféricas

Mango bimaterial ERGO™ para limas Cadenas de motosierra



9-486-C-10

File Size	File Width	Quantity	Part No.
3.2	3.2 mm	10	9-486-C-10

Mango bimaterial ERGO™ para limas Cadenas de motosierra



9-486-C-1P

File Size	File Width	Quantity	Part No.
3.2	3.2 mm	10	9-486-C-1P

Mango bimaterial ERGO™ para limas Redondas, cuadradas y triangulares



9-486...10

File Size	File Width	Quantity	Part No.
4	4	10	9-486-04-10
5	5	10	9-486-05-10
7	7	10	9-486-07-10
8	8	10	9-486-08-10

Mango bimaterial ERGO™ para limas Redondas, cuadradas y triangulares



9-486...1P

File Size	File Width	Quantity	Part No.
4	4	10	9-486-04-1P
5	5	20	9-486-05-1P
7	7	20	9-486-07-1P

Mango para limas de cadenas de motosierra



PH-6604

Weight (g)	Quantity	Part No.
55	15	PH-6604-1P
50	25	PH-6604-25





BAHCO



Llaves



LLAVES AJUSTABLES

Llave ajustable pavonada
Mordaza reversible para tubos (Serie P)

ergo®



90

L	g	g	g
158mm/6"	20	5	9070
208mm/8"	27	5	9071
257mm/10"	31	5	9072
308mm/12"	34	5	9073

Llave ajustable fosfatada moleta central ERGO™, con mordaza reversible

ergo®



90P

L	g	g	g
158mm/6"	21	5	9070 P
208mm/8"	28	5	9071 P
257mm/10"	33	5	9072 P
308mm/12"	35	5	9073 P

Llave ajustable cromada plateada
Mordaza reversible (Serie P)

ergo®



90C

L	g	g	g
158mm/6"	20	5	9070C
208mm/8"	27	5	9071C
257mm/10"	31	5	9072 C
308mm/12"	34	3	9073 C

Llave ajustable cromada moleta central ERGO™, con mordaza reversible

ergo®



90PC

L	g	g	g
158mm/6"	21	5	9070 PC
208mm/8"	28	5	9071 PC
257mm/10"	33	5	9072 PC
308mm/12"	35	3	9073 PC

Llave ajustable pavonada, gran apertura

ergo®



9029-9035

L	g	g	g
170mm/6"	32	5	9029
218mm/8"	38	5	9031
270mm/10"	46	5	9033
324mm/12"	55	5	9035

Llave ajustable especial
Con apertura de mordaza extra ancho

ergo®



9029C/9031C

L	g	g	g
170mm/6"	32	5	9029 C
218mm/8"	38	5	9031 C

Llave ajustable, gran apertura, mordazas extra finas

ergo®



9029-T/9031-T

L	g	g	g
170mm/6"	32	5	9029-T
218mm/8"	38	5	9031-T

Llave ajustable, gran apertura y mordazas reversibles

ergo®



9031P

L	g	g	g
218mm/8"	39	5	9031P

Juego 3 ajustables serie 90 con mango termoplástico (6", 8" y 10")

ergo®



ADJUST3-90

g	g	g
900	1	ADJUST3-90

9070, 9071, 9072



Juego de llaves 9031 & 9029



ADJUST9031/29

g			
550	3	ADJUST 9031/29	

9029, 9031

Llave ajustable, fosfatada



80

L			
110mm/4"	13	5	8069
155mm/6"	20	5	8070
205mm/8"	27	5	8071
255mm/10"	31	5	8072
305mm/12"	34	5	8073
380mm/15"	44	3	8074
455mm/18"	53	3	8075
110mm/4"	13	50	8069 IP
155mm/6"	20	40	8070 IP
205mm/8"	27	50	8071 IP
255mm/10"	31	30	8072 IP
305mm/12"	34	20	8073 IP
380mm/15"	44	20	8074 IP
455mm/18"	53	10	8075 IP

Llave ajustable moleta central, cromada



80C

L			
110mm/4"	13	5	8069 C
155mm/6"	20	5	8070 C
205mm/8"	27	5	8071 C

L			
255mm/10"	31	5	8072 C
305mm/12"	34	5	8073 C
380mm/15"	44	3	8074 C
455mm/18"	53	3	8075 C
110mm/4"	13	5	8069 C IP
155mm/6"	20	5	8070 C IP
205mm/8"	27	5	8071 C IP
255mm/10"	31	5	8072 C IP
305mm/12"	34	5	8073 C IP
380mm/15"	44	3	8074 C IP
455mm/18"	53	3	8075 C IP

IP: Embalaje industrial

Llave ajustable gran tamaño



86/87

L			
614mm/24"	63	1	86
770mm/30"	85	3	87

Juego 3 llaves ajustables serie 80 (6", 8" y 10")



ADJUST3

g			
810	1	ADJUST3	

8070, 8071, 8072

Repuestos para llaves ajustables
-1: mordaza/ -2: tornillo y muelle

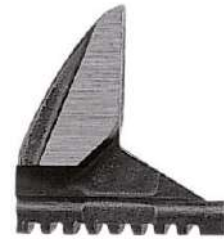

RPS

8069, 8069 C	1	8069-1	
8070, 8070 C, 9070, 9070 C	1	8070-1	
8071, 8071 C, 9071, 9071 C	1	8071-1	
8072, 8072 C, 9072, 9072 C	1	8072-1	
8073, 8073 C, 9073, 9073 C	1	8073-1	
8074, 8074 C	1	8074-1	
8075, 8075 C	1	8075-1	
9029, 9029 C, 31	1	9029-1	
9029-T	1	9029T-1	
9031, 9031 C	1	9031-1	
9031-T	1	9031T-1	
9033, 33H	1	9033-1	
9035	1	9035-1	
86	1	86-1	
87	1	87-1	
8069, 8069 C	1	8069-2	
8070, 8070 C, 9070, 9070 C, 9070 P, 9070 PC	1	8070-2	
8071, 8071 C, 9071, 9071 C, 9071 P, 9071 PC	1	8071-2	
8072, 8072 C, 9072, 9072 C, 9072 P, 9072 PC	1	8072-2	
8073, 8073 C, 9073, 9073 C, 9073 P, 9073 PC, 9033	1	8073-2	
8074, 8074 C, 9035	1	8074-2	
8075, 8075 C	1	8075-2	
9029, 9029 C, 9029-T, 9031-T, 31, 9031, 9031 C, 9031P	1	9029-2	
86	1	86-2	
87	1	87-2	
9031 P	1	9031 P-1	
9070 P, 9070 PC	1	9070 P-1	
9071 P, 9071 PC	1	9071 P-1	
9072 P, 9072 PC	1	9072 P-1	
9073 P, 9073 PC	1	9073 P-1	

-1: mordaza

-2: tornillo y muelle

Llave ajustable podger, serie larga



84

L			
405mm/16"	41	1	84-PODGER



Llave ajustable función tubo



31

L	Icon	Icon	Icon
205mm/8"	32	5	31
205mm/8"	32	50	31 IP

Llave ajustable para volantes de válvulas



33H

L	Icon	Icon	Icon
254mm/10"	46	5	33H

Llave ajustable fosfatada, Industria pesada
Mango termoplástico



95

L	Icon	Icon	Icon
208mm/8"	27	5	9571
257mm/10"	35	5	9572
308mm/12"	39.5	5	9573

Llave ajustable cromada plateada, Industria pesada
Mango termoplástico



95C

L	Icon	Icon	Icon
158mm/6"	20	5	9570C

Llave ajustable de moleta lateral



91C/97C

L	Icon	Icon	Icon
155mm/6"	21	5	91C
205mm/8"	29	5	92C
255mm/10"	34	5	93C
305mm/12"	39	5	94C
405mm/16"	48	1	95C
500mm/20"	60	1	96C
750mm/30"	77	1	97C

LLAVES COMBINADAS

Llaves combinadas, mm



111M

Icon	Icon	Icon
5.5	10	111M-5.5
6	10	111M-6
7	10	111M-7



Icon	Icon	Icon
8	10	111M-8
9	10	111M-9
10	10	111M-10
11	10	111M-11
12	10	111M-12
13	10	111M-13
14	10	111M-14
15	10	111M-15
16	10	111M-16
17	10	111M-17
18	10	111M-18
19	10	111M-19
20	10	111M-20
21	10	111M-21
22	5	111M-22
23	5	111M-23
24	5	111M-24
25	5	111M-25
26	5	111M-26
27	5	111M-27
28	5	111M-28
29	5	111M-29
30	5	111M-30
32	5	111M-32
33	5	111M-33
34	5	111M-34
36	1	111M-36
38	1	111M-38
41	1	111M-41
46	1	111M-46
50	1	111M-50
55	1	111M-55
60	1	111M-60
65	1	111M-65
70	1	111M-70
75	1	111M-75
80	1	111M-80
85	1	111M-85
90	1	111M-90
95	1	111M-95
100	1	111M-100
5.5	1	SB111M-5,5
6	1	SB111M-6
7	1	SB111M-7
8	1	SB111M-8
9	1	SB111M-9
10	1	SB111M-10
11	1	SB111M-11
12	1	SB111M-12
13	1	SB111M-13
14	1	SB111M-14
15	1	SB111M-15
16	1	SB111M-16
17	1	SB111M-17
18	1	SB111M-18
19	1	SB111M-19
20	1	SB111M-20
21	1	SB111M-21
22	1	SB111M-22
23	1	SB111M-23
24	1	SB111M-24
25	1	SB111M-25
26	1	SB111M-26
27	1	SB111M-27
28	1	SB111M-28
29	1	SB111M-29
30	1	SB111M-30
32	1	SB111M-32

SB- Presentación para colgar

Llave combinada, pulgadas





111Z



  		
1/4	5	111Z-1/4
5/16	5	111Z-5/16
3/8	5	111Z-3/8
7/16	5	111Z-7/16
1/2	5	111Z-1/2
9/16	5	111Z-9/16
5/8	5	111Z-5/8
11/16	5	111Z-11/16
3/4	5	111Z-3/4
13/16	5	111Z-13/16
7/8	5	111Z-7/8
15/16	3	111Z-15/16
1	3	111Z-1
1 1/16	5	111Z-1.1/16
1 1/8	5	111Z-1.1/8
1 1/4	5	111Z-1.1/4
1 5/16	5	111Z-1.5/16
1 3/8	1	111Z-1.3/8
1 7/16	1	111Z-1.7/16
1 1/2	1	111Z-1.1/2
1 5/8	1	111Z-1.5/8
1 11/16	1	111Z-1.11/16
1 3/4	1	111Z-1.3/4
1 13/16	1	111Z-1.13/16
1 7/8	1	111Z-1.7/8
2	1	111Z-2
2 1/8	1	111Z-2.1/8
2 1/4	1	111Z-2.1/4
2 3/8	1	111Z-2.3/8
2 1/2	1	111Z-2.1/2
2 5/8	1	111Z-2.5/8
2 3/4	1	111Z-2.3/4
2 7/8	1	111Z-2.7/8
3	1	111Z-3

Llave combinada stubby, pulgadas



1Z



  		
3/16	20	1Z-3/16
7/32	20	1Z-7/32
1/4	20	1Z-1/4
9/32	20	1Z-9/32
5/16	10	1Z-5/16
11/32	10	1Z-11/32
3/8	10	1Z-3/8
7/16	10	1Z-7/16
1/2	10	1Z-1/2
9/16	10	1Z-9/16

  		
5/8	10	1Z-5/8
11/16	10	1Z-11/16
3/4	10	1Z-3/4
13/16	10	1Z-13/16
7/8	10	1Z-7/8
15/16	5	1Z-15/16
1	10	1Z-1

Llave combinada, mm





S20

  		
6	1	SBS20-6
7	1	SBS20-7
8	1	SBS20-8
9	1	SBS20-9
10	1	SBS20-10
11	1	SBS20-11
12	1	SBS20-12
13	1	SBS20-13
14	1	SBS20-14
15	1	SBS20-15
16	1	SBS20-16
17	1	SBS20-17
18	1	SBS20-18
19	1	SBS20-19
20	1	SBS20-20
21	1	SBS20-21
22	1	SBS20-22
24	1	SBS20-24
27	1	SBS20-27
30	1	SBS20-30
32	1	SBS20-32

Juego de 5 llaves combinadas, mm



111M/SH5



  		
5	1	111M/SH5

111M-8, 111M-10, 111M-13, 111M-17, 111M-19

Juego de 8 llaves combinadas, mm



111M/SH8



  		
8	1	111M/SH8

111M-8, 111M-10, 111M-12, 111M-13, 111M-14, 111M-17, 111M-19, 111M-22

Juego de 12 llaves combinadas, mm



111M/SH12



  		
12	1	111M/SH12

111M-8, 111M-9, 111M-10, 111M-11, 111M-12, 111M-13, 111M-14, 111M-15, 111M-16, 111M-17, 111M-18, 111M-19

Juego de 10 llaves combinadas, mm



111M/

  		
10	1	111M/S10

111M-8, 111M-9, 111M-10, 111M-11, 111M-12, 111M-13, 111M-14, 111M-17, 111M-19, 111M-22



Juego de 11 llaves combinadas, mm



111M/11T



11 1 111M/11T

111M-8, 111M-9, 111M-10, 111M-11, 111M-12, 111M-13, 111M-14, 111M-15, 111M-17, 111M-19, 111M-22



Juego de 14 llaves combinadas, mm



111M/14T



14 1 111M/14T

111M-6, 111M-8, 111M-9, 111M-10, 111M-13, 111M-14, 111M-15, 111M-17, 111M-19, 111M-22, 111M-24, 111M-27, 111M-30, 111M-32



Juego de 17 llaves combinadas, mm



111M/17T



17 1 111M/17T

111M-6, 111M-7, 111M-8, 111M-9, 111M-10, 111M-11, 111M-12, 111M-13, 111M-14, 111M-15, 111M-16, 111M-17, 111M-18, 111M-19, 111M-20, 111M-21, 111M-22



Juego de 17 llaves combinadas, mm



111M/17TL

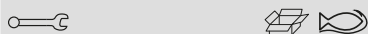

17 1 111M/17TL

111M-8, 111M-9, 111M-10, 111M-11, 111M-12, 111M-13, 111M-14, 111M-15, 111M-16, 111M-18, 111M-19, 111M-22, 111M-24, 111M-26, 111M-27, 111M-30, 111M-32



Juego de 24 llaves combinadas, mm



111M/24T

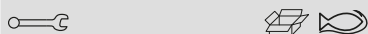

24 1 111M/24T

111M-6, 111M-7, 111M-8, 111M-9, 111M-10, 111M-11, 111M-12, 111M-13, 111M-14, 111M-15, 111M-16, 111M-17, 111M-18, 111M-19, 111M-20, 111M-21, 111M-22, 111M-24, 111M-26, 111M-27, 111M-28, 111M-30, 111M-32, 111M-36



Juego de 26 llaves combinadas, mm



111M/26T



26 1 111M/26T

111M-6, 111M-7, 111M-8, 111M-9, 111M-10, 111M-11, 111M-12, 111M-13, 111M-14, 111M-15, 111M-16, 111M-17, 111M-18, 111M-19, 111M-20, 111M-21, 111M-22, 111M-23, 111M-24, 111M-25, 111M-26, 111M-27, 111M-28, 111M-29, 111M-30, 111M-32



Juegos de 8 llaves combinadas, pulgadas



111Z/

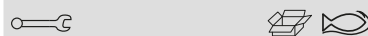

8 1 111Z/8T

111Z-1/2, 111Z-11/16, 111Z-3/4, 111Z-3/8, 111Z-5/8, 111Z-7/16, 111Z-7/8, 111Z-9/16



Juegos de 11 llaves combinadas, pulgadas



111Z/11T

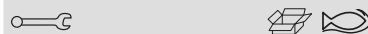

11 1 111Z/11T

111Z-1, 111Z-1/2, 111Z-11/16, 111Z-13/16, 111Z-15/16, 111Z-3/4, 111Z-3/8, 111Z-5/8, 111Z-7/16, 111Z-7/8, 111Z-9/16



Juegos de 6 llaves combinadas, mm



S20/

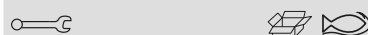

6 1 S20/SH6

SBS20-8, SBS20-10, SBS20-12,
SBS20-13, SBS20-14, SBS20-17



Juego de 12 llaves combinadas, mm



S20/SH12



12

1 S20/SH12

SBS20-8, SBS20-9, SBS20-10, SBS20-11, SBS20-12, SBS20-13, SBS20-14, SBS20-15, SBS20-16, SBS20-17, SBS20-18, SBS20-19



Juego de 10 llaves combinadas, mm



BS20/



10

1 BS20/S10

SBS20-8, SBS20-10, SBS20-11, SBS20-13, SBS20-14, SBS20-16, SBS20-17, SBS20-18, SBS20-19, SBS20-22



Llave combinada extra larga, mm



11M



8	5	11M-8
9	5	11M-9
10	5	11M-10
11	5	11M-11
12	5	11M-12
13	5	11M-13
14	5	11M-14
15	5	11M-15
16	5	11M-16
17	5	11M-17
18	5	11M-18
19	5	11M-19
21	5	11M-21
22	5	11M-22
24	5	11M-24
27	1	11M-27
30	1	11M-30
32	1	11M-32
36	1	11M-36
38	1	11M-38

Juego de 8 llaves combinadas, extra largas, mm



11M/



8

1 11M/S8

11M-8, 11M-9, 11M-10, 11M-11, 11M-13, 11M-14, 11M-17, 11M-19



Llave combinada Liliput, mm

Llave combinada acodada extra larga, pulgadas



11Z



3/8 in	5	11Z-3/8
7/16 in	5	11Z-7/16
1/2 in	5	11Z-1/2
9/16 in	5	11Z-9/16
5/8 in	5	11Z-5/8
11/16 in	5	11Z-11/16
3/4 in	5	11Z-3/4
13/16 in	5	11Z-13/16
15/16 in	5	11Z-15/16
1 in	5	11Z-1



4020L-M



3	5	4020L-M-3
3.2	5	4020L-M-3.2
3.5	5	4020L-M-3.5
4	5	4020L-M-4
4.5	5	4020L-M-4.5
5	5	4020L-M-5
5.5	5	4020L-M-5.5



Llaves combinadas acodadas, mm



1952M

6	10	1952M-6		
7	10	1952M-7		
8	10	1952M-8		
9	10	1952M-9		
10	10	1952M-10		
11	10	1952M-11		
12	10	1952M-12		
13	10	1952M-13		
14	10	1952M-14		
15	10	1952M-15		
16	10	1952M-16		
17	10	1952M-17		
18	10	1952M-18		
19	10	1952M-19		
20	10	1952M-20		
21	10	1952M-21		
22	5	1952M-22		
23	5	1952M-23		
24	5	1952M-24		
25	5	1952M-25		
26	5	1952M-26		
27	5	1952M-27		
28	1	1952M-28		
29	1	1952M-29		
30	1	1952M-30		
32	1	1952M-32		
34	1	1952M-34		
36	1	1952M-36		
41	1	1952M-41		
46	1	1952M-46		
50	1	1952M-50		
55	1	1952M-55		
60	1	1952M-60		
65	1	1952M-65		
70	1	1952M-70		
75	1	1952M-75		
80	1	1952M-80		
7	1	SB1952M-7		
8	1	SB1952M-8		
10	1	SB1952M-10		
12	1	SB1952M-12		
13	1	SB1952M-13		
14	1	SB1952M-14		
17	1	SB1952M-17		
19	1	SB1952M-19		
24	1	SB1952M-24		

Llave combinada acodada, pulgadas



1952Z

1/4	5	1952Z-1/4		
5/16	5	1952Z-5/16		
11/32	5	1952Z-11/32		
3/8	5	1952Z-3/8		
7/16	5	1952Z-7/16		
1/2	5	1952Z-1/2		
9/16	5	1952Z-9/16		
5/8	5	1952Z-5/8		
11/16	5	1952Z-11/16		
3/4	5	1952Z-3/4		
13/16	5	1952Z-13/16		
7/8	5	1952Z-7/8		
15/16	5	1952Z-15/16		
1	1	1952Z-1		
1 1/16	1	1952Z-1.1/16		
1 1/8	1	1952Z-1.1/8		
1 1/4	1	1952Z-1.1/4		
1 5/16	1	1952Z-1.5/16		
1 3/8	1	1952Z-1.3/8		
1 7/16	1	1952Z-1.7/16		
1 1/2	1	1952Z-1.1/2		
1 5/8	1	1952Z-1.5/8		

Llave combinada acodada, mm



PU

6	5	PU-6		
7	5	PU-7		
8	5	PU-8		
9	5	PU-9		
10	5	PU-10		
11	5	PU-11		
12	5	PU-12		
13	5	PU-13		
14	5	PU-14		

15	5	PU-15		
16	5	PU-16		
17	5	PU-17		
18	5	PU-18		
19	5	PU-19		
20	3	PU-20		
21	3	PU-21		
22	3	PU-22		
23	3	PU-23		
24	3	PU-24		
25	1	PU-25		
26	1	PU-26		
27	1	PU-27		
28	1	PU-28		
29	1	PU-29		
30	1	PU-30		
32	1	PU-32		
36	1	PU-36		
42	1	PU-42		

Producto no disponible para España

Juego de 6 llaves combinadas acodadas, mm



1952M/SH

6	1	1952M/SH6		

1952M-8, 1952M-10, 1952M-12, 1952M-13, 1952M-14, 1952M-17

Juego de 12 llaves combinadas acodadas, mm



1952M/SH12

12	1	1952M/SH12		

1952M-8, 1952M-9, 1952M-10, 1952M-11, 1952M-12, 1952M-13, 1952M-14, 1952M-15, 1952M-16, 1952M-17, 1952M-18, 1952M-19

Juego de 10 llaves combinadas, acodadas, mm



1952M/



10

1 1952M/10

1952M-10, 1952M-11, 1952M-12, 1952M-13, 1952M-14, 1952M-16, 1952M-17, 1952M-19, 1952M-8, 1952M-9



Juegos de 7 llaves combinadas acodadas, mm



1952M/T



7

1 1952M/7T

1952M-8, 1952M-10, 1952M-13, 1952M-14, 1952M-17, 1952M-19, 1952M-22



Juego de 14 llaves combinadas acodadas, mm



1952M/14T



14

1 1952M/14T

1952M-10, 1952M-13, 1952M-14, 1952M-15, 1952M-17, 1952M-19, 1952M-22, 1952M-24, 1952M-27, 1952M-30, 1952M-32, 1952M-6, 1952M-8, 1952M-9



Juego de 17 llaves combinadas, acodadas, mm



1952M/17T



17

1 1952M/17T

1952M-6, 1952M-7, 1952M-8, 1952M-9, 1952M-10, 1952M-11, 1952M-12, 1952M-13, 1952M-14, 1952M-15, 1952M-16, 1952M-17, 1952M-18, 1952M-19, 1952M-20, 1952M-21, 1952M-22



Juego de 26 llaves combinadas, acodadas, mm



1952M/26T



26

1 1952M/26T

1952M-6, 1952M-7, 1952M-8, 1952M-9, 1952M-10, 1952M-11, 1952M-12, 1952M-13, 1952M-14, 1952M-15, 1952M-16, 1952M-17, 1952M-18, 1952M-19, 1952M-20, 1952M-21, 1952M-22, 1952M-23, 1952M-24, 1952M-25, 1952M-26, 1952M-27, 1952M-28, 1952M-29, 1952M-30, 1952M-32



Juego de 11 llaves combinadas acodadas, pulgadas



1952Z/T



11

1 1952Z/11T

1952Z-1/2, 1952Z-1/4, 1952Z-11/16, 1952Z-13/16, 1952Z-3/4, 1952Z-3/8, 1952Z-5/16, 1952Z-5/8, 1952Z-7/16, 1952Z-7/8, 1952Z-9/16



LLAVES DE CARRACA

Llave combinada de carraca reversible



1RM



6

1 1RM-6

7

1 1RM-7

8

1 1RM-8

9

1 1RM-9

10

1 1RM-10

11

1 1RM-11

12

1 1RM-12

13

1 1RM-13

14

1 1RM-14

15

1 1RM-15

16

1 1RM-16

17

1 1RM-17

18

1 1RM-18

19

1 1RM-19

21

1 1RM-21

22

1 1RM-22

24

1 1RM-24

27

1 1RM-27

30

1 1RM-30

32

1 1RM-32



Llave combinada con carraca, pulgadas



1RZ

Size	Quantity	Part Number
1/4 in	1	1RZ-1/4
5/16 in	1	1RZ-5/16
11/32 in	1	1RZ-11/32
3/8 in	1	1RZ-3/8
7/16 in	1	1RZ-7/16
1/2 in	1	1RZ-1/2
9/16 in	1	1RZ-9/16
5/8 in	1	1RZ-5/8
11/16 in	1	1RZ-11/16
3/4 in	1	1RZ-3/4
7/8 in	1	1RZ-7/8
15/16 in	1	1RZ-15/16

Llave combinada con carraca extracorta, mm



10RM

Size	Quantity	Part Number
8	1	10RM-8
10	1	10RM-10
13	1	10RM-13
14	1	10RM-14
17	1	10RM-17
19	1	10RM-19

Llave combinada con carraca extracorta, pulgadas



10RZ

Size	Quantity	Part Number
5/16 in	1	10RZ-5/16
3/8 in	1	10RZ-3/8

Size	Quantity	Part Number
7/16 in	1	10RZ-7/16
1/2 in	1	10RZ-1/2
9/16 in	1	10RZ-9/16
5/8 in	1	10RZ-5/8
11/16 in	1	10RZ-11/16
3/4 in	1	10RZ-3/4

Llave combinada con carraca articulada, mm
En métrica



41RM

Size	Quantity	Part Number
8	1	41RM-8
10	1	41RM-10
11	1	41RM-11
12	1	41RM-12
13	1	41RM-13
14	1	41RM-14
17	1	41RM-17
19	1	41RM-19
21	1	41RM-21

Llave combinada con carraca articulada, pulgadas
En pulgadas



41RZ

Size	Quantity	Part Number
5/16 in	1	41RZ-5/16
3/8 in	1	41RZ-3/8
7/16 in	1	41RZ-7/16
1/2 in	1	41RZ-1/2
9/16 in	1	41RZ-9/16
5/8 in	1	41RZ-5/8
11/16 in	1	41RZ-11/16
3/4 in	1	41RZ-3/4
13/16 in	1	41RZ-13/16
7/8 in	1	41RZ-7/8

Juego de 6 llaves combinadas de carraca reversibles, mm



1RM/

Quantity	Part Number
6	1 1RM/SH6

1RM-8, 1RM-10, 1RM-12, 1RM-13, 1RM-14, 1RM-17

Juego de 8 llaves combinadas a carraca, mm



1RM/SH8

Quantity	Part Number
8	1 1RM/SH8

1RM-8, 1RM-10, 1RM-11, 1RM-12, 1RM-13, 1RM-14, 1RM-17, 1RM-19

Juego de 12 llaves combinadas a carraca, mm



1RM/SH12

Quantity	Part Number
12	10 1RM/SH12

1RM-8, 1RM-9, 1RM-10, 1RM-11, 1RM-12, 1RM-13, 1RM-14, 1RM-15, 1RM-16, 1RM-17, 1RM-18, 1RM-19

Juego 5 llaves combinadas a carraca, mm



1RM/S5

5	10	1RM/S5

1RM-8, 1RM-10, 1RM-13, 1RM-17, 1RM-19		
---------------------------------------	--	--

Juego de 8 llaves combinadas con carraca, pulgadas
En pulgadas



1RZ/

1	1RZ/SH8

1RZ-1/2, 1RZ-11/16, 1RZ-3/4, 1RZ-3/8, 1RZ-5/16, 1RZ-5/8, 1RZ-7/16, 1RZ-9/16		
---	--	--

Juego de llaves combinadas de carraca y adaptadores, 8 piezas
8 piezas



1RMA/S8

160 x 283 x 75 mm	1	1RMA/S8

1RMA-13-3/8-SQ, 1RMA-10-1/4-SQ, 1RMA-19-1/2-SQ		
1RMA-13-5/16-BIT, 1RMA-10-1/4-BIT		
1RM-10, 1RM-13, 1RM-19		

Juego de 6 llaves combinada con carraca extracortas, mm
En métrica



10RM/

1	10RM/SH6

10RM-8, 10RM-10, 10RM-13, 10RM-14, 10RM-17, 10RM-19		
---	--	--

Juego de 8 llaves combinadas con carraca articulada, mm
En métrica



41RM/SH8

8	10	41RM/SH8

41RM-8, 41RM-10, 41RM-11, 41RM-12, 41RM-13, 41RM-14, 41RM-17, 41RM-19		
---	--	--

Juego de llaves combinadas con carraca articuladas



42RM/S12

229 x 70 x 280 mm	1562 g	1	42RM/S12

Llave doble estrella plana a carraca, mm



1320RM

6-7	1	1320RM-6-7
8-9	1	1320RM-8-9
10-11	1	1320RM-10-11
12-13	1	1320RM-12-13
14-15	1	1320RM-14-15
16-17	1	1320RM-16-17
17-19 mm	1	1320RM-17-19
18-19	1	1320RM-18-19
22-24	1	1320RM-22-24

Llave doble estrella plana a carraca, pulgadas
En pulgadas



1320RZ

1/4-5/16" in	1	1320RZ-1/4-5/16
3/8-7/16" in	1	1320RZ-3/8-7/16
1/2-9/16" in	1	1320RZ-1/2-9/16
5/8-11/16" in	1	1320RZ-5/8-11/16
3/4-13/16" in	1	1320RZ-3/4-13/16
3/4-7/8" in	1	1320RZ-3/4-7/8
7/8-15/16" in	1	1320RZ-7/8-15/16



Llave doble de estrella a carraca acodada, pulgadas
En pulgadas



1321RZ

3/8-7/16 in	1	1321RZ-3/8-7/16
1/2-9/16 in	1	1321RZ-1/2-9/16
5/8-11/16 in	1	1321RZ-5/8-11/16
3/4x7/8 in	1	1321RZ-3/4-7/8

Llave doble de estrella plana a carraca



1320SRM

14-19	1	1320SRM-14-19

Juego de 8 llaves doble estrella plana a carraca, mm



1320RM/

8	1	1320RM/SH8

1320RM-8-9, 1320RM-10-11, 1320RM-12-13, 1320RM-14-15, 1320RM-16-17, 1320RM-18-19, 1320RM-22-24, 1320RM-6-7

Juego de llaves planas con carraca en S, 29 piezas



1320SRM/

29	1	1320SRM/S29

1320SRM-14-19		
1RMA-19-1/4-SQ		

Llave de carraca 4 en 1



S4RM

4x5 6x7 mm	1	S4RM-4-7
8x9 10x11 mm	1	S4RM-8-11
12x13 14x15 mm	1	S4RM-12-15
16x17 18x19 mm	1	S4RM-16-19
20x21 24x27 mm	1	S4RM-21-27
30x32 34x36 mm	1	S4RM-30-36

Juego de 3 llaves de carraca 4 en 1



S4RM/

3	20	S4RM/3T

S4RM-8-11, S4RM-12-15, S4RM-16-19

Juego de 4 llaves de carraca 4 en 1



S4RM/4T

4	1	S4RM/4T

S4RM-8-11, S4RM-12-15, S4RM-16-19, S4RM-21-27

Juego de 5 llaves de carraca 4 en 1



S4RM/5T

5	1	S4RM/5T

S4RM-8-11, S4RM-12-15, S4RM-16-19, S4RM-21-27, S4RM-30-36

Adaptador para llaves con carraca para vasos 1/4", 3/8", 1/2"



1RMA-SQ

1/4	10	1	1RMA-10-1/4-SQ	
3/8	13	1	1RMA-13-3/8-SQ	
1/2	19	1	1RMA-19-1/2-SQ	
1/4	19	1	1RMA-19-1/4-SQ	

Adaptador portapuntas para llaves con carraca



1RMA-BIT

1/4	10	1	1RMA-10-1/4-BIT	
5/16	13	1	1RMA-13-5/16-BIT	
10	13	1	1RMA-13-10-BIT	

Juego de 4 adaptadores para llaves de carraca
4 piezas



1RMA/S4

84 x 100 x 35 mm	1	1RMA/S4

1RMA-10-1/4-SQ, 1RMA-19-1/2-SQ	
1RMA-10-1/4-BIT	
1RMA-13-3/8-SQ	

LLAVES FIJAS DE UNA BOCA

Llave fija de dos bocas, mm



6M

4x5	10	6M-4-5
4.5x5.5	10	6M-4.5-5.5
5x5.5	10	6M-5-5.5
5.5x7	10	6M-5.5-7
6x7	10	6M-6-7
7x8	10	6M-7-8
8x9	10	6M-8-9
8x10	10	6M-8-10
10x11	10	6M-10-11
10x13	10	6M-10-13
12x13	10	6M-12-13
12x14	10	6M-12-14
13x14	10	6M-13-14
13x15	10	6M-13-15
13x16	10	6M-13-16
13x17	10	6M-13-17
14x15	10	6M-14-15
14x17	10	6M-14-17
16x17	10	6M-16-17
16x18	10	6M-16-18
17x19	10	6M-17-19
18x19	10	6M-18-19
19x22	10	6M-19-22
19x24	10	6M-19-24
20x22	10	6M-20-22
21x23	10	6M-21-23
21x24	10	6M-21-24
22x24	10	6M-22-24
24x26	10	6M-24-26
24x27	10	6M-24-27
24x30	5	6M-24-30
25x28	5	6M-25-28
27x29	5	6M-27-29
27x30	5	6M-27-30
27x32	5	6M-27-32
30x32	5	6M-30-32
30x36	5	6M-30-36
32x36	5	6M-32-36
34x36	1	6M-34-36
36x41	1	6M-36-41
38x42	1	6M-38-42
41x46	1	6M-41-46
46x50	1	6M-46-50
4x5	1	SB6M-4-5
6x7	1	SB6M-6-7
8x9	1	SB6M-8-9
10x11	1	SB6M-10-11
12x13	1	SB6M-12-13
14x15	1	SB6M-14-15
16x17	1	SB6M-16-17
17x19	1	SB6M-17-19
18x19	1	SB6M-18-19
20x22	1	SB6M-20-22
21x23	1	SB6M-21-23
22x24	1	SB6M-22-24
24x26	1	SB6M-24-26
24x27	1	SB6M-24-27

25x28	1	SB6M-25-28
27x29	1	SB6M-27-29
30x32	1	SB6M-30-32

SB- con clip para colgar

Llave fija de dos bocas, pulgadas



6Z

1/4x5/16	5	6Z-1/4-5/16
5/16x11/32	5	6Z-5/16-11/32
3/8x7/16	5	6Z-3/8-7/16
7/16x1/2	5	6Z-7/16-1/2
1/2x9/16	5	6Z-1/2-9/16
9/16x5/8	5	6Z-9/16-5/8
19/32x11/16	5	6Z-19/32-11/16
5/8x3/4	5	6Z-5/8-3/4
11/16x3/4	5	6Z-11/16-3/4
3/4x7/8	5	6Z-3/4-7/8
25/32x13/16	5	6Z-25/32-13/16
13/16x7/8	5	6Z-13/16-7/8
7/8x15/16	5	6Z-7/8-15/16
15/16x1	5	6Z-15/16-1
1x1 1/8	1	6Z-1-1.1/8
1 1/16x1 1/4	1	6Z-1.1/16-1.1/4
1 1/4x1 3/8	1	6Z-1.1/4-1.3/8

Llave fija de dos bocas, Liliput mm



1931M

4	5	1931M-4
4.5	5	1931M-4.5
5	5	1931M-5
5.5	5	1931M-5.5
6	5	1931M-6
7	5	1931M-7
8	5	1931M-8
9	5	1931M-9
10	5	1931M-10
11	5	1931M-11
12	5	1931M-12
13	5	1931M-13
14	5	1931M-14
17	5	1931M-17



Llave fija de dos bocas, Liliput pulgadas



1931Z

Diagram 1	Diagram 2	Diagram 3	Diagram 4
1/8 in	74	5	1931Z-1/8
5/32	80	5	1931Z-5/32
3/16	80	5	1931Z-3/16
13/64	80	5	1931Z-13/64
7/32	80	5	1931Z-7/32
15/64x1/4 in	84	5	1931Z-15/64-1/4
1/4	80	5	1931Z-1/4
9/32	90	5	1931Z-9/32
9/32x5/16 in	94	5	1931Z-9/32-5/16
5/16	90	5	1931Z-5/16
11/32	105	5	1931Z-11/32
11/32x3/8 in	94	5	1931Z-11/32-3/8
3/8	105	5	1931Z-3/8
7/16	120	5	1931Z-7/16
1/2	120	5	1931Z-1/2
9/16	130	5	1931Z-9/16
5/8	130	5	1931Z-5/8

Juego de 8 llaves fijas, mm
Soporte plástico con asa



6M/SH

Diagram 1	Diagram 2	Diagram 3	Diagram 4
8		1	6M/SH8

6M-6-7, 6M-8-9, 6M-10-11, 6M-12-13, 6M-14-15, 6M-16-17, 6M-18-19, 6M-20-22

Juego de 12 llaves fijas, mm
Colgador de plástico



6M/SH12

Diagram 1	Diagram 2	Diagram 3	Diagram 4
12		1	6M/SH12

6M-6-7, 6M-8-9, 6M-10-11, 6M-12-13, 6M-14-15, 6M-16-17, 6M-18-19, 6M-20-22, 6M-21-23, 6M-24-26, 6M-25-28, 6M-30-32

Juego de 8 llaves fijas de dos bocas, mm
En caja de cartón



6M/S

Diagram 1	Diagram 2	Diagram 3	Diagram 4
8		1	6M/S8

6M-6-7, 6M-8-9, 6M-10-11, 6M-12-13, 6M-14-15, 6M-16-17, 6M-18-19, 6M-20-22

Juego de 6 llaves fijas en clip, mm



6M/

Diagram 1	Diagram 2	Diagram 3	Diagram 4
6		1	6M/6C

6M-6-7, 6M-8-9, 6M-10-11, 6M-12-13, 6M-14-15, 6M-16-17

Juego de 8 llaves fijas en clip, mm



6M/8C

Diagram 1	Diagram 2	Diagram 3	Diagram 4
8		1	6M/8C

6M-6-7, 6M-8-9, 6M-10-11, 6M-12-13, 6M-14-15, 6M-16-17, 6M-18-19, 6M-20-22

Juego de 10 llaves fijas en clip, mm



6M/10C

Diagram 1	Diagram 2	Diagram 3	Diagram 4
10		1	6M/10C

6M-6-7, 6M-8-9, 6M-10-11, 6M-12-13, 6M-14-15, 6M-16-17, 6M-18-19, 6M-20-22, 6M-24-27, 6M-30-32

Juego de 12 llaves fijas en clip, mm



6M/12C



12

1 6M/12C

6M-6-7, 6M-8-9, 6M-10-11, 6M-12-13, 6M-14-15, 6M-16-17, 6M-18-19, 6M-20-22, 6M-21-23, 6M-24-27, 6M-25-28, 6M-30-32

Juego de 8 llaves fijas de dos bocas, pulgadas



6Z/



1 6Z/8C

6Z-1/2-9/16, 6Z-1/4-5/16, 6Z-13/16-7/8, 6Z-15/16-1, 6Z-19/32-11/16, 6Z-3/8-7/16, 6Z-5/16-11/32, 6Z-5/8-3/4

Juego de 6 llaves fijas de dos bocas Colgador de plástico



S10/



6

1 S10/SH6

SBS10-10-11, SBS10-12-13, SBS10-14-15, SBS10-16-17, SBS10-18-19, SBS10-8-9

Juego de 11 llaves fijas Colgador de plástico



S10/SH11



11

1 S10/SH11

SBS10-10-11, SBS10-12-13, SBS10-14-15, SBS10-16-17, SBS10-17-19, SBS10-18-19, SBS10-20-22, SBS10-21-23, SBS10-24-27, SBS10-6-7, SBS10-8-9

Juego de 10 llaves fijas de dos bocas, Liliput



1931M/



1 1931M/10T

1931M-4, 1931M-4.5, 1931M-5, 1931M-5.5, 1931M-6, 1931M-7, 1931M-8, 1931M-9, 1931M-10, 1931M-11

Juego de 12 llaves fijas de dos bocas, Liliput



1931Z/



1 1931Z/12T

1931Z-1/2, 1931Z-1/4, 1931Z-11/32, 1931Z-3/16, 1931Z-3/8, 1931Z-5/16, 1931Z-5/32, 1931Z-5/8, 1931Z-7/16, 1931Z-7/32, 1931Z-9/16, 1931Z-9/32

Juego de 6 llaves fijas de dos bocas para electrónica



1933M/



1 1933M/6T

Llave magneto en anillo



3280M/



8

1 3280M

Llave fija Crowfoot 1/4"



-677



7 mm	1/4 in	1 677-7
8 mm	1/4 in	1 677-8
9 mm	1/4 in	1 677-9
10 mm	1/4 in	1 677-10
13 mm	1/4 in	1 677-13
3/8 in	1/4 in	1 677-3/8



Llave fija Crowfoot 3/8"



1.5/8 in	3/8 in	1	747-1.5/8
1.11/16 in	3/8 in	1	747-1.11/16
1.3/4 in	3/8 in	1	747-1.3/4
1.13/16 in	3/8 in	1	747-1.13/16
1.7/8 in	3/8 in	1	747-1.7/8
1.15/16 in	3/8 in	1	747-1.15/16
2 in	3/8 in	1	747-2
2.1/16 in	3/8 in	1	747-2.1/16
2.1/8 in	3/8 in	1	747-2.1/8
2.3/16 in	3/8 in	1	747-2.3/16
2.1/4 in	3/8 in	1	747-2.1/4
2.5/16 in	3/8 in	1	747-2.5/16
2.3/8 in	3/8 in	1	747-2.3/8
2.7/16 in	3/8 in	1	747-2.7/16
2.1/2 in	3/8 in	1	747-2.1/2
2.9/16 in	3/8 in	1	747-2.9/16
2.5/8 in	3/8 in	1	747-2.5/8
2.3/4 in	3/8 in	1	747-2.3/4
2.7/8 in	3/8 in	1	747-2.7/8

-747

10 mm	3/8 in	1	747-10
11 mm	3/8 in	1	747-11
12 mm	3/8 in	1	747-12
13 mm	3/8 in	1	747-13
14 mm	3/8 in	1	747-14
15 mm	3/8 in	1	747-15
16 mm	3/8 in	1	747-16
17 mm	3/8 in	1	747-17
18 mm	3/8 in	1	747-18
19 mm	3/8 in	1	747-19
20 mm	3/8 in	1	747-20
21 mm	3/8 in	1	747-21
22 mm	3/8 in	1	747-22
23 mm	3/8 in	1	747-23
24 mm	3/8 in	1	747-24
25 mm	3/8 in	1	747-25
26 mm	3/8 in	1	747-26
27 mm	3/8 in	1	747-27
28 mm	3/8 in	1	747-28
30 mm	3/8 in	1	747-30
32 mm	3/8 in	1	747-32
34 mm	3/8 in	1	747-34
36 mm	3/8 in	1	747-36
40 mm	3/8 in	1	747-40
41 mm	3/8 in	1	747-41
42 mm	3/8 in	1	747-42
46 mm	3/8 in	1	747-46
50 mm	3/8 in	1	747-50
3/8 in	3/8 in	1	747-3/8
7/16 in	3/8 in	1	747-7/16
1/2 in	3/8 in	1	747-1/2
9/16 in	3/8 in	1	747-9/16
5/8 in	3/8 in	1	747-5/8
11/16 in	3/8 in	1	747-11/16
3/4 in	3/8 in	1	747-3/4
13/16 in	3/8 in	1	747-13/16
7/8 in	3/8 in	1	747-7/8
15/16 in	3/8 in	1	747-15/16
1 in	3/8 in	1	747-1
1.1/16 in	3/8 in	1	747-1.1/16
1.1/8 in	3/8 in	1	747-1.1/8
1.3/16 in	3/8 in	1	747-1.3/16
1.1/4 in	3/8 in	1	747-1.1/4
1.5/16 in	3/8 in	1	747-1.5/16
1.3/8 in	3/8 in	1	747-1.3/8
1.7/16 in	3/8 in	1	747-1.7/16
1.1/2 in	3/8 in	1	747-1.1/2
1.9/16 in	3/8 in	1	747-1.9/16

Llave fija Crowfoot 1/2"



-787

1.1/16 in	1/2 in	1	787-1.1/16
1.1/8 in	1/2 in	1	787-1.1/8
1.3/16 in	1/2 in	1	787-1.3/16
1.1/4 in	1/2 in	1	787-1.1/4
1.5/16 in	1/2 in	1	787-1.5/16
1.3/8 in	1/2 in	1	787-1.3/8
1.7/16 in	1/2 in	1	787-1.7/16
1.1/2 in	1/2 in	1	787-1.1/2
1.5/8 in	1/2 in	1	787-1.5/8
1.11/16 in	1/2 in	1	787-1.11/16
1.3/4 in	1/2 in	1	787-1.3/4
1.13/16 in	1/2 in	1	787-1.13/16
1.7/8 in	1/2 in	1	787-1.7/8
2 in	1/2 in	1	787-2
2.1/8 in	1/2 in	1	787-2.1/8
2.3/16 in	1/2 in	1	787-2.3/16
2.1/4 in	1/2 in	1	787-2.1/4
2.3/8 in	1/2 in	1	787-2.3/8

Llave fija DIN894 de una boca



894M

7	78	10	894M-7
8	94	10	894M-8
9	100	10	894M-9
10	106	10	894M-10
11	112	10	894M-11
12	125	10	894M-12
13	125	10	894M-13
14	140	10	894M-14
15	140	10	894M-15
16	140	10	894M-16
17	158	10	894M-17
19	171	10	894M-19
21	195	5	894M-21
22	195	5	894M-22
24	216	5	894M-24
27	240	5	894M-27
30	262	5	894M-30
32	274	5	894M-32
34	274	1	894M-34
36	303	5	894M-36
38	305	1	894M-38
41	343	1	894M-41
46	378	1	894M-46
50	413	1	894M-50
55	457	1	894M-55
60	492	1	894M-60
65	528	1	894M-65
70	573	1	894M-70
75	608	1	894M-75
80	644	1	894M-80
85	690	1	894M-85
90	690	1	894M-90
95	850	1	894M-95
100	1000	1	894M-100
105	1000	1	894M-105
110	1000	1	894M-110
115	1000	1	894M-115
120	1000	1	894M-120
125	1000	1	894M-125
130	1000	1	894M-130
135	1000	1	894M-135

LLAVES DE ESTRELLA DE DOS BOCAS

Llave de estrella acodada, mm



2M

Diagram	L	Diagram	Diagram
6x7	165	5	2M-6-7
8x9	180	5	2M-8-9
8x10	180	5	2M-8-10
10x11	190	5	2M-10-11
10x13	190	5	2M-10-13
12x13	210	5	2M-12-13
13x17	243	5	2M-13-17
14x15	226	5	2M-14-15
16x17	246	5	2M-16-17
16x18	246	5	2M-16-18
17x19	266	5	2M-17-19
18x19	266	5	2M-18-19
19x22	291	5	2M-19-22
20x22	291	5	2M-20-22
21x23	306	5	2M-21-23
22x24	306	5	2M-22-24
24x26	326	5	2M-24-26
24x27	326	5	2M-24-27
25x28	336	5	2M-25-28
27x29	351	1	2M-27-29
27x30	351	5	2M-27-30
27x32	353	5	2M-27-32
30x32	362	5	2M-30-32
32x36	416	1	2M-32-36
36x41	444	1	2M-36-41
41x46	483	1	2M-41-46
46x50	541	1	2M-46-50

Llave doble de estrella, extra acodada



ZZ

Diagram	L	Diagram	Diagram
1/4x5/16	165	1	ZZ-1/4-5/16
5/16x3/8	180	1	ZZ-5/16-3/8
3/8x7/16	190	1	ZZ-3/8-7/16

Diagram	L	Diagram	Diagram
1/2x9/16	210	1	ZZ-1/2-9/16
9/16x5/8	225.8	1	ZZ-9/16-5/8
5/8x11/16	245.5	1	ZZ-5/8-11/16
3/4x7/8	290.5	1	ZZ-3/4-7/8
13/16x7/8	290.5	1	ZZ-13/16-7/8
15/16x1	325.8	1	ZZ-15/16-1
1x1 1/8	335.9	1	ZZ-1-1.1/8
1 1/16x1 1/4	353	1	ZZ-1.1/16-1.1/4

Llave de estrella de dos bocas acodada, pulgadas



1300Z

Diagram	L	Diagram	Diagram
1/4x5/16	156	1	1300Z-1/4-5/16
3/8x7/16	193	1	1300Z-3/8-7/16
1/2x9/16	220	1	1300Z-1/2-9/16
19/32x11/16	258	1	1300Z-19/32-11/16
5/8x3/4	278	1	1300Z-5/8-3/4
25/32x13/16	300	1	1300Z-25/32-13/16
7/8x15/16	334	1	1300Z-7/8-15/16
15/16x1	352	1	1300Z-15/16-1
1x1.1/8	380	1	1300Z-1-1.1/8

Juego de 8 llaves de estrella de dos bocas extra-acodadas, mm



2M/S

Diagram	Diagram	Diagram
8	1	2M/S8

2M-6-7, 2M-8-9, 2M-10-11, 2M-12-13, 2M-14-15, 2M-16-17, 2M-18-19, 2M-20-22

Juego de 8 llaves de estrella de dos bocas extra-acodadas, mm



2M/T

Diagram	Diagram	Diagram
8	1	2M/8T

2M-6-7, 2M-8-9, 2M-10-11, 2M-12-13, 2M-14-15, 2M-16-17, 2M-18-19, 2M-20-22

Juego de 10 llaves de estrella de dos bocas acodadas, mm



2M/10T

Diagram	Diagram	Diagram
10	1	2M/10T

2M-6-7, 2M-8-9, 2M-10-11, 2M-12-13, 2M-14-15, 2M-16-17, 2M-18-19, 2M-20-22, 2M-21-23, 2M-24-27

Juego de 12 llaves de estrella de dos bocas acodadas, mm



2M/12T

Diagram	Diagram	Diagram
12	1	2M/12T

2M-6-7, 2M-8-9, 2M-10-11, 2M-12-13, 2M-14-15, 2M-16-17, 2M-18-19, 2M-20-22, 2M-21-23, 2M-24-27, 2M-25-28, 2M-30-32



Juego de 13 llaves de estrella acodada, mm



2M/

13	1 2M/13

2M-6-7, 2M-8-9, 2M-10-11, 2M-12-13, 2M-14-15, 2M-16-17, 2M-18-19, 2M-20-22, 2M-21-23, 2M-24-27, 2M-25-28, 2M-30-32, 2M-36-41

Juego de 7 llaves estrella acodada dos bocas, pulgadas



2Z/T

7	1 2Z/T

2Z-1/2-9/16, 2Z-1/4-5/16, 2Z-3/4-7/8, 2Z-3/8-7/16, 2Z-5/16-3/8, 2Z-5/8-11/16, 2Z-9/16-5/8

Llave de estrella plana de dos bocas, mm



4M

6x7	95	10 4M-6-7
8x9	110	10 4M-8-9
10x11	125	10 4M-10-11
12x13	140	10 4M-12-13

14x15	155	10	4M-14-15
16x17	170	10	4M-16-17
17x19	170	10	4M-17-19
18x19	185	10	4M-18-19
20x22	205	10	4M-20-22
21x23	225	5	4M-21-23
24x26	250	1	4M-24-26
24x27	255	1	4M-24-27
25x28	275	1	4M-25-28
27x29	275	1	4M-27-29
30x32	300	1	4M-30-32

Llave de estrella de dos bocas larga, pulgadas



44Z

1/4x5/16 in	197	10	44Z-1/4-5/16
5/16x3/8 in	238	10	44Z-5/16-3/8
3/8x7/16 in	284	10	44Z-3/8-7/16
7/16x1/2 in	326	10	44Z-7/16-1/2
1/2x9/16 in	358	10	44Z-1/2-9/16
5/8x3/4 in	401	5	44Z-5/8-3/4
11/16x3/4 in	401	5	44Z-11/16-3/4
11/16x13/16 in	410	5	44Z-11/16-13/16

Llave de estrella de media luna, mm



1943M

11x13	150	1	1943M-11-13
13x15	185	1	1943M-13-15
13x17	185	1	1943M-13-17
14x16	185	1	1943M-14-16
14x17	185	1	1943M-14-17
15x17	185	1	1943M-15-17
19x22	235	1	1943M-19-22

Llave de estrella de media luna, pulgadas



1943Z

5/16x3/8 in	153	1	1943Z-5/16-3/8
7/16x1/2 in	153	1	1943Z-7/16-1/2
9/16x5/8 in	186	1	1943Z-9/16-5/8
5/8x3/4 in	233	1	1943Z-5/8-3/4
11/16x13/16 in	233	1	1943Z-11/16-13/16

Juego de 10 llaves de estrella plana de dos bocas, mm



4M/T

	1 4M/10T

4M-6-7, 4M-8-9, 4M-10-11, 4M-12-13, 4M-14-15, 4M-16-17, 4M-18-19, 4M-20-22, 4M-24-27, 4M-30-32

Juego de 10 llaves de estrella plana de dos bocas, pulgadas



4M/C

10	1 4M/10C

4M-6-7, 4M-8-9, 4M-10-11, 4M-12-13,
4M-14-15, 4M-16-17, 4M-18-19, 4M-20-
22, 4M-21-23, 4M-24-27



Juego de 12 llaves estrella plana, mm



4M/12C



12

1 4M/12C

4M-6-7, 4M-8-9, 4M-10-11, 4M-12-13,
4M-14-15, 4M-16-17, 4M-18-19, 4M-20-22,
4M-21-23, 4M-24-27, 4M-25-28, 4M-30-32



Juego de 8 llaves planas de dos bocas, mm



4M/



8

1 4M/8

4M-6-7, 4M-8-9, 4M-10-11, 4M-12-13, 4M-
14-15, 4M-16-17, 4M-18-19, 4M-20-22



LLAVES PARA RACORES

Llave para racores dos bocas, mm



1949M



8x 9
10x11

140
150

1 1949M-8-9
1 1949M-10-11



10x12	150	1	1949M-10-12
12x13	170	1	1949M-12-13
12x14	170	1	1949M-12-14
14x15	170	1	1949M-14-15
14x17	200	1	1949M-14-17
17x19	210	1	1949M-17-19
19x22	220	1	1949M-19-22
22x24	235	1	1949M-22-24
24x27	255	1	1949M-24-27
30x32	280	1	1949M-30-32

Llaves para racores, dos bocas, pulgadas



1949Z



3/8x7/16	150	1	1949Z-3/8-7/16
1/2x9/16	170	1	1949Z-1/2-9/16
5/8x3/4	210	1	1949Z-5/8-3/4
3/4x7/8	220	1	1949Z-3/4-7/8
1x1 1/8	255	1	1949Z-1-1.1/8

Llave Crowfoot 3/8", ajustable



1950MZ



0-29 / 0-1.1/8"	3/8	1	1950MZ-3/8
-----------------	-----	---	------------

Llave Crowfoot 1/4", para racores



-679



7 mm	1/4 in	1	679-7
8 mm	1/4 in	1	679-8
9 mm	1/4 in	1	679-9
10 mm	1/4 in	1	679-10
11 mm	1/4 in	1	679-11
12 mm	1/4 in	1	679-12
13 mm	1/4 in	1	679-13
14 mm	1/4 in	1	679-14
3/8 in	1/4 in	1	679-3/8
7/16 in	1/4 in	1	679-7/16
1/2 in	1/4 in	1	679-1/2
9/16 in	1/4 in	1	679-9/16

Llave Crowfoot 3/8", para racores



-749



15 mm	3/8 in	1	749-15
16 mm	3/8 in	1	749-16
17 mm	3/8 in	1	749-17
18 mm	3/8 in	1	749-18
19 mm	3/8 in	1	749-19
20 mm	3/8 in	1	749-20
21 mm	3/8 in	1	749-21
22 mm	3/8 in	1	749-22
23 mm	3/8 in	1	749-23
24 mm	3/8 in	1	749-24
25 mm	3/8 in	1	749-25
26 mm	3/8 in	1	749-26
27 mm	3/8 in	1	749-27
3/8 in	3/8 in	1	749-3/8



7/16 in	3/8 in	1	749-7/16
1/2 in	3/8 in	1	749-1/2
9/16 in	3/8 in	1	749-9/16
5/8 in	3/8 in	1	749-5/8
11/16 in	3/8 in	1	749-11/16
3/4 in	3/8 in	1	749-3/4
13/16 in	3/8 in	1	749-13/16
7/8 in	3/8 in	1	749-7/8
15/16 in	3/8 in	1	749-15/16
1 in	3/8 in	1	749-1
1.1/16 in	3/8 in	1	749-1.1/16
1.1/8 in	3/8 in	1	749-1.1/8
1.3/16 in	3/8 in	1	749-1.3/16
1.1/4 in	3/8 in	1	749-1.1/4
1.5/16 in	3/8 in	1	749-1.5/16
1.3/8 in	3/8 in	1	749-1.3/8
1.7/16 in	3/8 in	1	749-1.7/16
1.1/2 in	3/8 in	1	749-1.1/2
1.9/16 in	3/8 in	1	749-1.9/16
1.5/8 in	3/8 in	1	749-1.5/8
1.11/16 in	3/8 in	1	749-1.11/16
1.3/4 in	3/8 in	1	749-1.3/4
1.13/16 in	3/8 in	1	749-1.13/16
1.7/8 in	3/8 in	1	749-1.7/8
1.15/16 in	3/8 in	1	749-1.15/16
2 in	3/8 in	1	749-2
2.1/8 in	3/8 in	1	749-2.1/8
2.3/16 in	3/8 in	1	749-2.3/16
2.1/4 in	3/8 in	1	749-2.1/4
2.3/8 in	3/8 in	1	749-2.3/8
2.5/8 in	3/8 in	1	749-2.5/8
2.3/4 in	3/8 in	1	749-2.3/4
3.1/8 in	3/8 in	1	749-3.1/8

Llave Crowfoot 1/2", para racores



-789

28 mm	1/2 in	1	789-28
30 mm	1/2 in	1	789-30
32 mm	1/2 in	1	789-32
34 mm	1/2 in	1	789-34
36 mm	1/2 in	1	789-36
38 mm	1/2 in	1	789-38
40 mm	1/2 in	1	789-40
41 mm	1/2 in	1	789-41
42 mm	1/2 in	1	789-42
46 mm	1/2 in	1	789-46
50 mm	1/2 in	1	789-50
1.1/8 in	1/2 in	1	789-1.1/8
1.1/4 in	1/2 in	1	789-1.1/4
1.5/16 in	1/2 in	1	789-1.5/16
1.3/8 in	1/2 in	1	789-1.3/8
1.7/16 in	1/2 in	1	789-1.7/16

1.1/2 in	1/2 in	1	789-1.1/2
1.9/16 in	1/2 in	1	789-1.9/16
1.5/8 in	1/2 in	1	789-1.5/8
1.3/4 in	1/2 in	1	789-1.3/4
1.13/16 in	1/2 in	1	789-1.13/16
2 in	1/2 in	1	789-2
2.1/4 in	1/2 in	1	789-2.1/4
2.5/16 in	1/2 in	1	789-2.5/16
2.3/8 in	1/2 in	1	789-2.3/8

LLAVES DE GOLPEO

Llave de estrella de golpeo, mm



7444SG-M

24		1	7444SG-M-24
27		1	7444SG-M-27
30		1	7444SG-M-30
32		1	7444SG-M-32
34		1	7444SG-M-34
36		1	7444SG-M-36
38		1	7444SG-M-38
41		1	7444SG-M-41
42		1	7444SG-M-42
46		1	7444SG-M-46
50		1	7444SG-M-50
55		1	7444SG-M-55
60		1	7444SG-M-60
65		1	7444SG-M-65
70		1	7444SG-M-70
75		1	7444SG-M-75
80		1	7444SG-M-80
85		1	7444SG-M-85
90		1	7444SG-M-90
95		1	7444SG-M-95
100		1	7444SG-M-100
105		1	7444SG-M-105
110		1	7444SG-M-110
115		1	7444SG-M-115
120		1	7444SG-M-120
125		1	7444SG-M-125
130		1	7444SG-M-130
135		1	7444SG-M-135
140		1	7444SG-M-140
145		1	7444SG-M-145
150		1	7444SG-M-150
155		1	7444SG-M-155
160		1	7444SG-M-160
165		1	7444SG-M-165
170		1	7444SG-M-170
175		1	7444SG-M-175

Llave de estrella de golpeo, pulgadas



7444SG-Z



1 1/16		1	7444SG-Z-1.1/16
1 1/8		1	7444SG-Z-1.1/8
1 3/16		1	7444SG-Z-1.3/16
1 1/4		1	7444SG-Z-1.1/4
1 5/16		1	7444SG-Z-1.5/16
1 3/8		1	7444SG-Z-1.3/8
1 7/16		1	7444SG-Z-1.7/16
1 1/2		1	7444SG-Z-1.1/2
1 5/8		1	7444SG-Z-1.5/8
1 11/16		1	7444SG-Z-1.11/16
1 3/4		1	7444SG-Z-1.3/4
1 13/16		1	7444SG-Z-1.13/16
1 7/8		1	7444SG-Z-1.7/8
2		1	7444SG-Z-2
2 1/16		1	7444SG-Z-2.1/16
2 1/8		1	7444SG-Z-2.1/8
2 3/16		1	7444SG-Z-2.3/16
2 1/4		1	7444SG-Z-2.1/4
2 3/8		1	7444SG-Z-2.3/8
2 9/16		1	7444SG-Z-2.9/16
2 5/8		1	7444SG-Z-2.5/8
2 3/4		1	7444SG-Z-2.3/4
3		1	7444SG-Z-3
3 1/8		1	7444SG-Z-3.1/8
3 3/8		1	7444SG-Z-3.3/8
3 1/2		1	7444SG-Z-3.1/2
3 3/4		1	7444SG-Z-3.3/4
3 7/8		1	7444SG-Z-3.7/8
4		1	7444SG-Z-4
4 1/8		1	7444SG-Z-4.1/8
4 1/2		1	7444SG-Z-4.1/2

Llave fija de golpeo, mm



133SGM



27		1	133SGM-27
30		1	133SGM-30
32		1	133SGM-32
36		1	133SGM-36
41		1	133SGM-41
46		1	133SGM-46
50		1	133SGM-50

		
55	1	133SGM-55
60	1	133SGM-60
65	1	133SGM-65
70	1	133SGM-70
75	1	133SGM-75
80	1	133SGM-80
85	1	133SGM-85
90	1	133SGM-90
95	1	133SGM-95
100	1	133SGM-100
105	1	133SGM-105
110	1	133SGM-110
115	1	133SGM-115
120	1	133SGM-120

Llave de estrella de impacto extra-acodada, mm





315M



		
27	1	315M-27
30	1	315M-30
32	1	315M-32
36	1	315M-36
41	1	315M-41
46	1	315M-46
50	1	315M-50
55	1	315M-55
60	1	315M-60
65	1	315M-65
70	1	315M-70
75	1	315M-75
80	1	315M-80

Llave de estrella de impacto extra-acodada, pulgadas



315Z



		
1.1/16	1	315Z-1.1/16
1.1/8	1	315Z-1.1/8
1.3/16	1	315Z-1.3/16

		
1.1/4	1	315Z-1.1/4
1.5/16	1	315Z-1.5/16
1.3/8	1	315Z-1.3/8
1.7/16	1	315Z-1.7/16
1.1/2	1	315Z-1.1/2
1.5/8	1	315Z-1.5/8
1.11/16	1	315Z-1.11/16
1.3/4	1	315Z-1.3/4
1.13/16	1	315Z-1.13/16
1.7/8	1	315Z-1.7/8
1.15/16	1	315Z-1.15/16
2	1	315Z-2
2.1/16	1	315Z-2.1/16
2.1/8	1	315Z-2.1/8
2.3/16	1	315Z-2.3/16
2.1/4	1	315Z-2.1/4
2.5/16	1	315Z-2.5/16
2.3/8	1	315Z-2.3/8
2.1/2	1	315Z-2.1/2
2.9/16	1	315Z-2.9/16
2.5/8	1	315Z-2.5/8
2.3/4	1	315Z-2.3/4
2.7/8	1	315Z-2.7/8
2.15/16	1	315Z-2.15/16
3	1	315Z-3
3.1/8	1	315Z-3.1/8

Llave a tracción, extra-acodada, mm







310M

		
24	1	310M-24
27	1	310M-27
30	1	310M-30
32	1	310M-32
36	1	310M-36
38	1	310M-38
41	1	310M-41
46	1	310M-46
50	1	310M-50
55	1	310M-55
60	1	310M-60
65	1	310M-65
70	1	310M-70
75	1	310M-75
80	1	310M-80
85	1	310M-85
90	1	310M-90
95	1	310M-95

Mango tubular



R310





			
24-30	19	1	R310-0
32-41	22	1	R310-1
46-55	25	1	R310-2
60-95	30	1	R310-3

LLAVES DE TUBO

Llave de pipa abierta, mm
Bi-hex. en extremo acodado / hex. en extremo recto



28M

			
6	6 mm	5	28M-6
7	7 mm	5	28M-7
8	8 mm	5	28M-8
9	9 mm	5	28M-9
10	10 mm	5	28M-10
11	11 mm	5	28M-11
12	12 mm	5	28M-12
13	13 mm	5	28M-13
14	14 mm	5	28M-14
15	15 mm	5	28M-15
16	16 mm	5	28M-16
17	17 mm	5	28M-17
18	18 mm	3	28M-18
19	19 mm	3	28M-19
20	20 mm	3	28M-20
21	21 mm	3	28M-21
22	22 mm	3	28M-22
23	23 mm	3	28M-23
24	24 mm	3	28M-24
25	25 mm	3	28M-25
26	26 mm	3	28M-26
27	27 mm	3	28M-27
28	28 mm	1	28M-28
29	29 mm	1	28M-29
30	30 mm	1	28M-30
32	32 mm	1	28M-32



Llave de pipa abierta, mm hexagonal x hexagonal



29M



6	5	29M-6
7	5	29M-7
8	5	29M-8
9	5	29M-9
10	5	29M-10
11	5	29M-11
12	5	29M-12
13	5	29M-13
14	5	29M-14
15	5	29M-15
16	5	29M-16
17	5	29M-17
18	3	29M-18
19	3	29M-19
20	3	29M-20
21	3	29M-21
22	3	29M-22
23	3	29M-23
24	3	29M-24
25	3	29M-25
26	3	29M-26
27	3	29M-27
28	1	29M-28
29	1	29M-29
30	1	29M-30
32	1	29M-32

Juego de 11 llaves de pipa abiertas, mm



28M/11



11

1 28M/11

28M-8, 28M-9, 28M-10, 28M-11, 28M-12, 28M-13, 28M-14, 28M-15, 28M-17, 28M-19, 28M-22

Juego de 8 llaves de pipa abiertas, mm



29M/



8

1 29M/8

29M-8, 29M-10, 29M-12, 29M-13, 29M-14, 29M-17, 29M-19, 29M-22

Juego de 12 llaves de pipa abiertas, mm



28M/12



12

1 28M/12

28M-8, 28M-9, 28M-10, 28M-11, 28M-12, 28M-13, 28M-14, 28M-15, 28M-16, 28M-17, 28M-18, 28M-19

Juego de 10 llaves de pipa abiertas, mm



29M/10



10

1 29M/10

29M-8, 29M-10, 29M-11, 29M-12, 29M-13, 29M-14, 29M-16, 29M-17, 29M-18, 29M-19

Juego de 8 llaves de pipa abierta, mm



28M/



1 28M/8

28M-8, 28M-10, 28M-11, 28M-13, 28M-16, 28M-17, 28M-18, 28M-19

Juego de 15 llaves de pipa abiertas, mm



28M/15



15

1 28M/15

28M-8, 28M-9, 28M-10, 28M-11, 28M-12, 28M-13, 28M-14, 28M-15, 28M-16, 28M-17, 28M-18, 28M-19, 28M-21, 28M-22, 28M-24

Juego de 14 llaves de pipa abiertas, mm



29M/14



14

1 29M/14

29M-8, 29M-9, 29M-10, 29M-11, 29M-12, 29M-13, 29M-14, 29M-16, 29M-17, 29M-19, 29M-21, 29M-22, 29M-23, 29M-24

Llave de tubo de dos bocas estampada hex, mm



1936M

Size	Quantity	Part Number
6x7	50	1936M-6-7
8x9	5	1936M-8-9
8x10	30	1936M-8-10
10x11	25	1936M-10-11
10x13	25	1936M-10-13
12x13	25	1936M-12-13
13x17	20	1936M-13-17
14x15	5	1936M-14-15
14x17	15	1936M-14-17
16x17	15	1936M-16-17
17x19	10	1936M-17-19
18x19	10	1936M-18-19
19x22	8	1936M-19-22
20x22	8	1936M-20-22
21x23	8	1936M-21-23
22x24	5	1936M-22-24
24x26	5	1936M-24-26
24x27	5	1936M-24-27
25x28	5	1936M-25-28
30x32	1	1936M-30-32
30x34	4	1936M-30-34
36x41	4	1936M-36-41
46x50	2	1936M-46-50

Llave de tubo dos bocas, mm



27M

Size	Quantity	Part Number
6x7	10	27M-6-7
8x9	10	27M-8-9
10x11	10	27M-10-11
12x13	10	27M-12-13
13x17*	10	27M-13-17
14x15	10	27M-14-15
16x17*	10	27M-16-17
16x18*	10	27M-16-18
18x19*	10	27M-18-19
20x22*	10	27M-20-22
21x23*	5	27M-21-23
21x24*	5	27M-21-24
24x26*	5	27M-24-26
24x27*	5	27M-24-27
25x28*	5	27M-25-28



27x29*	5	27M-27-29
30x32*	5	27M-30-32
6x7	10	SB27M-6-7
8x9	10	SB27M-8-9
10x11	10	SB27M-10-11
12x13	10	SB27M-12-13
14x15	10	SB27M-14-15
16x17*	10	SB27M-16-17
18x19*	10	SB27M-18-19
20x22*	10	SB27M-20-22
21x23*	5	SB27M-21-23
24x26*	5	SB27M-24-26

* Con agujero para mango escalonado (26S)

Juego de 7 llaves de tubo de dos bocas, mm



1936M/

Quantity	Part Number
7	1936M/7

1936M-8-9, 1936M-10-11, 1936M-12-13, 1936M-14-15, 1936M-16-17, 1936M-18-19, 1936M-20-22, 26S-610

Juego de 12 llaves de tubo de dos bocas, mm



1936M/12

Quantity	Part Number
12	1936M/12

1936M-6-7, 1936M-8-9, 1936M-10-11, 1936M-12-13, 1936M-14-15, 1936M-16-17, 1936M-18-19, 1936M-20-22, 1936M-21-23, 1936M-24-27, 1936M-25-28, 1936M-30-32, 26S-1216, 26S-16, 26S-610

Juego de 8 llaves de tubo dos bocas forjadas, mm



27M/T

Quantity	Part Number
8	1 27M/8T

27M-6-7, 27M-8-9, 27M-10-11, 27M-12-13, 27M-14-15, 27M-16-17, 27M-18-19, 27M-20-22

Juego 12 llaves tubo en bolsa



27M/12T

Quantity	Part Number
12	1 27M/12T

27M-6-7, 27M-8-9, 27M-10-11, 27M-12-13, 27M-14-15, 27M-16-17, 27M-18-19, 27M-20-22, 27M-21-23, 27M-24-26, 27M-25-28, 27M-30-32

Juego de 6 llaves de tubo dos bocas forjadas, mm



27M/

Quantity	Part Number
6	1 27M/6

27M-6-7, 27M-8-9, 27M-10-11, 27M-12-13, 27M-14-15, 27M-16-17



Juego de 8 llaves de tubo de dos bocas forjadas, mm



27M/8



8

1 27M/8

27M-6-7, 27M-8-9, 27M-10-11, 27M-12-13, 27M-14-15, 27M-16-17, 27M-18-19, 27M-20-22



Juego de 10 llaves de tubo de dos bocas forjadas, mm



27M/10



10

1 27M/10

27M-6-7, 27M-8-9, 27M-10-11, 27M-12-13, 27M-14-15, 27M-16-17, 27M-18-19, 27M-20-22, 27M-21-23, 27M-24-26



Juego de 12 llaves de tubo de dos bocas forjadas, mm



27M/12



12

1 27M/12

27M-6-7, 27M-8-9, 27M-10-11, 27M-12-13, 27M-14-15, 27M-16-17, 27M-18-19, 27M-20-22, 27M-21-23, 27M-24-26, 27M-25-28, 27M-30-32



Mango escalonado para llave de tubo



26S



6 8 10
12 14
16 mm

10 26S-610
8 26S-1216
5 26S-16

Llave de vaso articulada de dos bocas, bihexagonal, mm



4040M



6x7 mm
8x9 mm
10x11 mm
10x13 mm
12x13 mm
13x17 mm
14x15 mm
16x17 mm
16x18 mm
17x19 mm
18x19 mm
20x22 mm
21x23 mm
24x27 mm

1 4040M-6-7
1 4040M-8-9
1 4040M-10-11
1 4040M-10-13
1 4040M-12-13
1 4040M-13-17
1 4040M-14-15
1 4040M-16-17
1 4040M-16-18
1 4040M-17-19
1 4040M-18-19
1 4040M-20-22
1 4040M-21-23
1 4040M-24-27

Juego de 6 llaves de vaso articuladas de dos bocas, bihexagonal, mm



4040M/S6



6

1 4040M/S6

4040M-8-9, 4040M-10-11, 4040M-12-13, 4040M-14-15, 4040M-16-17, 4040M-18-19



Juegos de 6 llaves de vaso articuladas de dos bocas, bihexagonal, mm



4040M/6T



1 4040M/6T

4040M-8-9, 4040M-10-11, 4040M-12-13, 4040M-14-15, 4040M-16-17, 4040M-18-19



LLAVES UNIVERSALES

Llave universal 5 en 1



MK5



97x25

1 MK5

Perfil: Cuadrado hembra: 5,6,7-8mm
Triángulo hembra: 9mm

Llave 9 en 1



MK9



95x95 1 MK9

Perfil cuadrado: 5,6,7-8,9-10mm Triángulo:
7,8-9,10-11mm Dos posiciones 3-5 y cierre semiluna 6mm

LLAVES DE GANCHO ARTICULADAS

Llave de gancho articulada, mm



4106

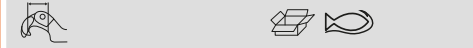

19-50 mm	10	4106-19-50
20-35 mm	1	4106-20-35
32-75 mm	10	4106-32-75
35-60 mm	1	4106-35-60
60-90 mm	1	4106-60-90
90-155 mm	5	4106-90-155
155-230 mm	1	4106-155-230

llave de gancho articulado tipo pin, mm



40B

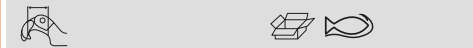

19-50 mm	10	40B-19-50
22-35 mm	1	40B-22-35
32-75 mm	10	40B-32-75
35-60 mm	1	40B-35-60

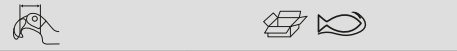

50-120 mm	10	40B-50-120
60-90 mm	1	40B-60-90
95-155 mm	1	40B-95-155
115-165 mm	10	40B-115-165
165-230 mm	1	40B-165-230

Llave pivote, ajustable



4307/4310

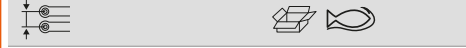

10-50 mm	1	4307
22-100 mm	1	4310





BAHCO



Vasos y accesorios



1/4"

Vaso 1/4", hexagonal, mm
Perfil hexagonal, en mm



6700SM

Size	Quantity	Part Number
4	5	6700SM-4
4.5	5	6700SM-4.5
5	5	6700SM-5
5.5	5	6700SM-5.5
6	5	6700SM-6
7	5	6700SM-7
8	5	6700SM-8
9	5	6700SM-9
10	5	6700SM-10
11	5	6700SM-11
12	5	6700SM-12
13	5	6700SM-13
14	5	6700SM-14
4	1	SB6700SM-4
4.5	1	SB6700SM-4.5
5	1	SB6700SM-5
5.5	1	SB6700SM-5.5
6	1	SB6700SM-6
7	1	SB6700SM-7
8	1	SB6700SM-8
9	1	SB6700SM-9
10	1	SB6700SM-10
11	1	SB6700SM-11
12	1	SB6700SM-12
13	1	SB6700SM-13
14	1	SB6700SM-14

SB- Con clip para colgar

Vaso, hexagonal 1/4", pulgadas
Perfil hexagonal, en pulgadas



6700SZ

Size	Quantity	Part Number
1/8	5	6700SZ-1/8
5/32	5	6700SZ-5/32
3/16	5	6700SZ-3/16
7/32	5	6700SZ-7/32
1/4	5	6700SZ-1/4
9/32	5	6700SZ-9/32
5/16	5	6700SZ-5/16

Size	Quantity	Part Number
11/32	5	6700SZ-11/32
3/8	5	6700SZ-3/8
7/16	5	6700SZ-7/16
1/2	5	6700SZ-1/2
9/16	5	6700SZ-9/16
1/8 in	5	SB6700SZ-1/8
5/32	1	SB6700SZ-5/32
3/16	1	SB6700SZ-3/16
7/32	1	SB6700SZ-7/32
1/4	1	SB6700SZ-1/4
9/32	1	SB6700SZ-9/32
5/16	1	SB6700SZ-5/16
11/32	1	SB6700SZ-11/32
3/8	1	SB6700SZ-3/8
7/16	1	SB6700SZ-7/16
1/2	1	SB6700SZ-1/2
9/16	1	SB6700SZ-9/16

Vaso TORX® hembra 1/4"
Para tornillos TORX®



6700TORX-E

Size	Quantity	Part Number
E4	5	6700TORX-E4
E5	5	6700TORX-E5
E6	5	6700TORX-E6
E7	5	6700TORX-E7
E8	5	6700TORX-E8
E10	5	6700TORX-E10
E4	1	SB6700TORX-E4
E5	1	SB6700TORX-E5
E6	1	SB6700TORX-E6
E7	1	SB6700TORX-E7
E8	1	SB6700TORX-E8
E10	1	SB6700TORX-E10

SB: Clip para colgar

Vaso bihexagonal 1/4" mm
Perfil bi-hexagonal, en mm. Paredes finas.



A6700DM

Size	Quantity	Part Number
5	5	A6700DM-5
5.5	5	A6700DM-5.5

Size	Quantity	Part Number
6	5	A6700DM-6
7	5	A6700DM-7
8	5	A6700DM-8
9	5	A6700DM-9
10	5	A6700DM-10
11	5	A6700DM-11
12	5	A6700DM-12
13	5	A6700DM-13
14	5	A6700DM-14
5	1	SBA6700DM-5
5.5	1	SBA6700DM-5.5
6	1	SBA6700DM-6
7	1	SBA6700DM-7
8	1	SBA6700DM-8
9	1	SBA6700DM-9
10	1	SBA6700DM-10
11	1	SBA6700DM-11
12	1	SBA6700DM-12
13	1	SBA6700DM-13
14	1	SBA6700DM-14

Aplicables en la industria aeroespacial

Vaso, bihexagonal 1/4" pulgadas
Perfil bi-hexagonal, en pulgadas. Paredes finas.



A6700DZ

Size	Quantity	Part Number
3/16	5	A6700DZ-3/16
7/32	5	A6700DZ-7/32
1/4	5	A6700DZ-1/4
9/32	5	A6700DZ-9/32
5/16	5	A6700DZ-5/16
11/32	5	A6700DZ-11/32
3/8	5	A6700DZ-3/8
7/16	5	A6700DZ-7/16
1/2	5	A6700DZ-1/2
9/16	5	A6700DZ-9/16
3/16	1	SBA6700DZ-3/16
7/32	1	SBA6700DZ-7/32
1/4	1	SBA6700DZ-1/4
9/32	1	SBA6700DZ-9/32
5/16	1	SBA6700DZ-5/16
11/32	1	SBA6700DZ-11/32
3/8	1	SBA6700DZ-3/8
7/16	1	SBA6700DZ-7/16
1/2	1	SBA6700DZ-1/2
9/16	1	SBA6700DZ-9/16

SB: Clip para colgar

Vaso 1/4" Bihex serie larga, mm
Perfil bi-hexagonal, en mm. Paredes finas.



A6800DM

Size	Quantity	Part Number
4	1	A6800DM-4
5	1	A6800DM-5
5.5	1	A6800DM-5.5
6	1	A6800DM-6
7	1	A6800DM-7
8	1	A6800DM-8
9	1	A6800DM-9
10	1	A6800DM-10
11	1	A6800DM-11
12	1	A6800DM-12
13	1	A6800DM-13
14	1	A6800DM-14
4	10	SBA6800DM-4
5	10	SBA6800DM-5
5.5	10	SBA6800DM-5.5
6	10	SBA6800DM-6
7	10	SBA6800DM-7
8	10	SBA6800DM-8
9	10	SBA6800DM-9
10	10	SBA6800DM-10
11	10	SBA6800DM-11
12	10	SBA6800DM-12
13	10	SBA6800DM-13
14	10	SBA6800DM-14

SB: Clip para colgar

Vaso hexagonal largo 1/4"
En métrica. Paredes finas.



A6800SM

Size	Quantity	Part Number
4 mm	1	A6800SM-4
4.5 mm	1	A6800SM-4.5
5 mm	1	A6800SM-5
6 mm	1	A6800SM-6
7 mm	1	A6800SM-7
8 mm	1	A6800SM-8
9 mm	1	A6800SM-9
10 mm	1	A6800SM-10

Size	Quantity	Part Number
11 mm	1	A6800SM-11
12 mm	1	A6800SM-12
13 mm	1	A6800SM-13
14 mm	1	A6800SM-14
15 mm	1	A6800SM-15

Vaso 1/4" hexagonal, serie larga, en pulgadas
Perfil hexagonal, en pulgadas. Paredes finas



A6800SZ

Size	Quantity	Part Number
1/8 in	1	A6800SZ-1/8
5/32" in	1	A6800SZ-5/32

Vaso 1/4" Bihex serie larga, pulgadas
Perfil bi-hexagonal, en pulgadas. Paredes finas.



A6800DZ

Size	Quantity	Part Number
3/16	1	A6800DZ-3/16
7/32	1	A6800DZ-7/32
1/4	1	A6800DZ-1/4
9/32	1	A6800DZ-9/32
5/16	1	A6800DZ-5/16
11/32	1	A6800DZ-11/32
3/8	1	A6800DZ-3/8
7/16	1	A6800DZ-7/16
1/2	1	A6800DZ-1/2
9/16	1	A6800DZ-9/16
3/16	10	SBA6800DZ-3/16
7/32	10	SBA6800DZ-7/32
1/4	10	SBA6800DZ-1/4
9/32	10	SBA6800DZ-9/32
5/16	10	SBA6800DZ-5/16
11/32	10	SBA6800DZ-11/32
3/8	10	SBA6800DZ-3/8
7/16	10	SBA6800DZ-7/16
1/2	10	SBA6800DZ-1/2
9/16	10	SBA6800DZ-9/16

SB: Clip para colgar

Vaso articulado 1/4", bihexagonal, mm
Perfil bi-hexagonal, en mm. Paredes finas.



A6710DM

Size	Quantity	Part Number
5.5	1	A6710DM-5.5
6	1	A6710DM-6
7	1	A6710DM-7
8	1	A6710DM-8
9	1	A6710DM-9
10	1	A6710DM-10
11	1	A6710DM-11
12	1	A6710DM-12
13	1	A6710DM-13
14	1	A6710DM-14

Vaso articulado, cuadrado 1/4"
Bi-hexagonal, pulgadas



A6710DZ

Size	Quantity	Part Number
3/16	1	A6710DZ-3/16
7/32	1	A6710DZ-7/32
1/4	1	A6710DZ-1/4
9/32	1	A6710DZ-9/32
5/16	1	A6710DZ-5/16
11/32	1	A6710DZ-11/32
3/8	1	A6710DZ-3/8
7/16	1	A6710DZ-7/16
1/2	1	A6710DZ-1/2
9/16	1	A6710DZ-9/16

Berbiquí 1/4", con mango de acero giratorio



6952N

Length	Quantity	Part Number
410 mm	1	6952N



Mango articulado, 1/4"



6958

L	Part
153	1 6958
153	1 SB6958

SB: Clip para colgar

Mango corredizo en T de 1/4"



6954

L	Part
140	1 6954
115	10 SB6954

SB: Clip para colgar

Destornillador portavasos 1/4"
Con cuadrado de 1/4" hembra en el mango



6956

L	Part
150	1 6956
150	1 SB6956

SB: Clip para colgar

Alargadera 1/4"
SB= en blister



6960 - 6962L

L	Part
50	1 6960
101	1 6961
152	1 6962

L	Part
355	1 6962L
53	1 SB6960
101	1 SB6961
55	1 SB6962
355	1 SB6962L

SB: Clip para colgar (blister)

Alargadera angular de 1/4"



6960-W - 6962-W

L	Part
50	1 6960-W
150	1 6962-W

Alargadera con moleteado 1/4"



696EX

L	Part
26 mm	1 696EX-01
51 mm	1 696EX-02
102 mm	1 696EX-04
152 mm	1 696EX-06
200 mm	1 696EX-08
276 mm	1 696EX-11

Alargadera flexible de 1/4"



6963

L	Part
148	1 6963
148	1 SB6963

SB: Clip para colgar (blister)

Articulación universal de 1/4"



6966

L	Part
35	1 6966
35	1 SB6966

SB: Clip para colgar

Articulación universal de 1/4", funcionamiento fluido



6968

L	Part
35	1 6968

Amplificador entrada 1/4" a salida 3/8"



7765

Input	Output	Part
1/4"	3/8"	1 7765
1/4"	3/8"	1 SB7765

SB: Clip para colgar

Adaptador 1/4" para puntas 1/4"



6709HL

Part	Quantity
1/4" in	1 6709HL

Adaptador portapuntas hexagonal 1/4"



6972H

1/4"	1/4"	5	6972H

Adaptador 1/4" para puntas 1/4"



6973M

1/4"	1/4" in	1	6973M

Adaptador 1/4" para puntas 1/4"



6973A

1/4 in	1	6973A

Aumentador plano de entrada 1/4" a salida 3/8"
Con imán en el disco



7767

1/4	1	7767
1/4	1	SB7767

SB: Clip para colgar

Juego de aumentadores planos 7767,8167,8967



8967/S3

110 x 194 x 30 mm	1	8967/S3

7767

8167

8967

Regleta para vasos



RAIL-187/264/340

187	3	RAIL-187
264	3	RAIL-264
340	3	RAIL-340

Clips 1/4"



C1/4

17	25	CLIPS-1/4

Vasos con puntas recta 1/4"



6709F

0.6	4.5	5	6709F-4.5
0.8	5.5	5	6709F-5.5
0.9	6.5	5	6709F-6.5
1.2	8	5	6709F-8
0.6	4.5	1	SB6709F-4.5
0.8	5.5	1	SB6709F-5.5
0.9	6.5	1	SB6709F-6.5
1.2	8	1	SB6709F-8

SB: Clip para colgar

Vasos con puntas Phillips 1/4"



6709PH

1	5	6709PH-1
2	5	6709PH-2
3	5	6709PH-3
1	1	SB6709PH-1
2	1	SB6709PH-2
3	1	SB6709PH-3

SB: Clip para colgar

Vasos con puntas Pozidriv 1/4"



6709PZ

1	5	6709PZ-1
2	5	6709PZ-2
3	5	6709PZ-3
1	1	SB6709PZ-1
2	1	SB6709PZ-2
3	1	SB6709PZ-3

SB: Clip para colgar



Vasos con punta TORX® 1/4"



6709TORX

6709TORX	
T8	5 6709TORX-T8
T9	5 6709TORX-T9
T10	5 6709TORX-T10
T15	5 6709TORX-T15
T20	5 6709TORX-T20
T25	5 6709TORX-T25
T27	5 6709TORX-T27
T30	5 6709TORX-T30
T40	5 6709TORX-T40
T8	1 SB6709TORX-T8
T9	1 SB6709TORX-T9
T10	1 SB6709TORX-T10
T15	1 SB6709TORX-T15
T20	1 SB6709TORX-T20
T25	1 SB6709TORX-T25
T27	1 SB6709TORX-T27
T30	1 SB6709TORX-T30
T40	1 SB6709TORX-T40

SB: Clip para colgar

Vasos con puntas TORX® inviolable 1/4"



6709TORX-R

6709TORX-R	
TR 8	1 6709TORX-R-T8
TR 10	1 6709TORX-R-T10
TR 15	1 6709TORX-R-T15
TR 20	1 6709TORX-R-T20
TR 25	1 6709TORX-R-T25
TR 8	1 SB6709TORX-R-T8
TR 10	1 SB6709TORX-R-T10
TR 15	1 SB6709TORX-R-T15
TR 20	1 SB6709TORX-R-T20
TR 25	1 SB6709TORX-R-T25

SB: Clip para colgar

Vaso cuadradillo 1/4" con puntas TORX PLUS® 1/4"



6709-IP

6709-IP		
IP10	M3	1 6709-IP10
IP15	-	1 6709-IP15
IP20	M4	1 6709-IP20
IP25	M5	1 6709-IP25
IP27	-	1 6709-IP27
IP30	M6	1 6709-IP30
IP40	M8	1 6709-IP40
IP45	-	1 6709-IP45

Vasos con puntas hexagonales 1/4"



6709M

6709M	
3	5 6709M-3
4	5 6709M-4
5	5 6709M-5
6	5 6709M-6
8	5 6709M-8
3	1 SB6709M-3
4	1 SB6709M-4
5	1 SB6709M-5
6	1 SB6709M-6
8	1 SB6709M-8

SB: Clip para colgar

Vaso con punta hex 1/4" serie larga, mm
En métrica.



A6709M

A6709M	
2.5	1 A6709M-2.5
3	1 A6709M-3
4	1 A6709M-4

A6709M	
5	1 A6709M-5
6	1 A6709M-6
2.5	1 SBA6709M-2.5
3	1 SBA6709M-3
4	1 SBA6709M-4
5	1 SBA6709M-5
6	1 SBA6709M-6

SB: Clip para colgar

Vaso con punta hex 1/4" serie larga, pulgadas
En pulgadas



A6709Z

A6709Z	
1/8	1 A6709Z-1/8
9/64	1 A6709Z-9/64
5/32	1 A6709Z-5/32
3/16	1 A6709Z-3/16
1/8	1 SBA6709Z-1/8
9/64	1 SBA6709Z-9/64
5/32	1 SBA6709Z-5/32
3/16	1 SBA6709Z-3/16

SB: Clip para colgar

Llave de carraca 1/4" con bloqueo 72 dientes
Cabeza reducida



6950SL

6950SL		
119	72	1 6950SL

Llave de carraca reversible 1/4" 72 dientes 5° ángulo de acción
 Ángulo de acción. Sellado. SB=en blíster



6950

121	72	1	6950
121	72	1	SB6950

SB=embalaje en blíster

Llave de carraca reversible, 1/4" 72 dientes/5° ángulo de acción
 Flecha indicadora.



6950RN

121	72	1	6950RN
121	72	1	SB6950RN

SB=embalaje en blíster

Llave de carraca reversible para válvulas de refrigeración



R6950

160	32	1	R6950



Llave de carraca reversible 1/4"
 Embalaje en blíster



SBS61

145	60	1	SBS61

Llave de carraca 1/4" reversible
 60 dientes / 6° ángulo de acción



SBS61S

120 mm	60	1	SBS61S

Carraca 1/4" con cabeza giratoria



8120-1/4

149 mm	72	20	8120-1/4

Adaptador para llave de carraca 1/4"
 60 dientes / Ángulo de acción de 6°



6951

40	1	6951

Kit de reparación para carraca 1/4" - 6950



6950-SPARE

12	6950	1	6950-SPARE

Kit de reparación para carraca 1/4 6950RN



6950RN-SPARE

6	6950RN	1	6950RN-SPARE

Kit de reparación para carraca 1/4" 6950SL



6950SL-SPARE

10	6950SL	1	6950SL-SPARE

Juego de llaves de vaso 1/4", 12 piezas
 Caja de metal



6712R

31 x 110 x 178 mm	1	6712R

6700SM-4, 6700SM-5, 6700SM-5.5,
 6700SM-6, 6700SM-7, 6700SM-8,
 6700SM-10, 6700SM-11, 6700SM-13

6950

6960, 6962



Juego de llaves de vaso 1/4", 12 piezas
Caja de metal



6712RN

31 x 108 x 178 mm 1 6712RN

- 6700SM-4, 6700SM-5, 6700SM-5.5, 6700SM-6, 6700SM-7, 6700SM-8, 6700SM-10, 6700SM-11, 6700SM-13
- 6960, 6962
- 6950RN

Juego de llaves de vaso 1/4", 15 piezas
Caja de metal



A6716DM

35 x 111 x 223 mm 1 A6716DM

- A6700DM-5.5, A6700DM-6, A6700DM-7, A6700DM-8, A6700DM-9, A6700DM-10, A6700DM-11, A6700DM-12, A6700DM-13, A6700DM-14
- 6956
- 6962
- 6966
- 6954
- 6950

Juego de llaves de vaso 1/4", 16 piezas
Caja de metal



6715MGS

34 x 113 x 223 mm 1 6715MGS

- SB6700SM-4, 6700SM-4.5, 6700SM-5, 6700SM-5.5, 6700SM-6, 6700SM-7, 6700SM-8, 6700SM-9, 6700SM-10, 6700SM-11, 6700SM-13
- 6954
- 6950RN
- 6956
- 6966
- 6962

Juego de llaves vaso 1/4", 19 piezas
Caja de metal



6719MHR

50 x 110 x 220 mm 1 6719MHR

- 6700SM-4, 6700SM-4.5, 6700SM-5.5, 6700SM-5, 6700SM-6, 6700SM-7, 6700SM-8, 6700SM-9, 6700SM-10, 6700SM-11, 6700SM-12, 6700SM-13, 6700SM-14
- 6950RN
- 6960, 6962
- 6954
- 6956
- 6966

Juego de llaves vaso 1/4", 15 piezas
Caja de metal



6729MHR

50 x 110 x 220 mm 1 6729MHR

- 6700SM-4, 6700SM-5, 6700SM-6, 6700SM-7, 6700SM-8, 6700SM-9, 6700SM-10, 6700SM-11, 6700SM-13, 6700SM-14
- 6950RN
- 6960, 6962
- 6966
- 6956
- 6973A
- 59S/PH1, 59S/PH2, 59S/PH3
- 59S/PZ1, 59S/PZ2, 59S/PZ3
- 59S/0.6-4.5, 59S/0.8-5.5, 59S/1.2-6.5
- 59S/H3, 59S/H4, 59S/H5, 59S/H6

Juego de llaves vaso 1/4", 16 piezas
Caja de metal



6729MHP

50 x 110 x 220 mm 1 6729MHP

- 6700SM-4, 6700SM-5, 6700SM-6, 6700SM-7, 6700SM-8, 6700SM-9, 6700SM-10, 6700SM-11, 6700SM-13, 6700SM-14
- 6950
- 6960, 6962
- 6966
- 6956
- 6973A
- 59S/0.6-4.5, 59S/0.8-5.5, 59S/1.2-6.5
- 59S/PZ1, 59S/PZ2, 59S/PZ3
- 59S/PH1, 59S/PH2, 59S/PH3
- 59S/H3, 59S/H4, 59S/H5, 59S/H6

Juego de llaves vaso 1/4", 17 piezas
Caja de metal



6717MBP

50 x 110 x 220 mm	1	6717MBP

A6700DM-5, A6700DM-5.5, A6700DM-6, A6700DM-7, A6700DM-8, A6700DM-9, A6700DM-10, A6700DM-11, A6700DM-12, A6700DM-13, A6700DM-14		
6950		
6960, 6962		
6954		
6966		
6956		

Juego de llaves de vaso 1/4", 27 piezas
Caja de metal



6730MBP

50 x 110 x 220 mm	1	6730MBP

A6700DM-5, A6700DM-5.5, A6700DM-6, A6700DM-7, A6700DM-8, A6700DM-9, A6700DM-10, A6700DM-11, A6700DM-12, A6700DM-13, A6700DM-14		
6950		
6960, 6962		
6954		
6966		
6956		
6973A		
59S/0.6-4.5, 59S/1.2-6.5, 59S/0.8-5.5		
59S/PH1, 59S/PH2, 59S/PH3		
59S/PZ1, 59S/PZ2, 59S/PZ3		
59S/H3, 59S/H4, 59S/H5, 59S/H6		

Juego de llaves de vaso 1/4", 17 piezas
Caja de metal



6719SM

41 x 113 x 223 mm	1	6719SM

6700SM-4, 6700SM-4.5, 6700SM-5, 6700SM-5.5, 6700SM-6, 6700SM-7, 6700SM-8, 6700SM-9, 6700SM-10, 6700SM-11, 6700SM-12, 6700SM-13		
6954		
6950		
6956		
6966		
6962		

Juego de llaves de vaso 1/4", 20 piezas
Caja de metal



6715MG

35 x 111 x 223 mm	1	6715MG

6700SM-4, 6700SM-4.5, 6700SM-5, 6700SM-5.5, 6700SM-6, 6700SM-7, 6700SM-8, 6700SM-9, 6700SM-10, 6700SM-11, 6700SM-13, 6700SM-14, 6700SM-12		
6954		
6958		
6956		
6962, 6960		
6966		
6950RN		

Juego de llaves de vaso 1/4", 21 piezas
Caja de metal



6721NM

41 x 113 x 223 mm	1	6721NM

6700SM-4, 6700SM-4.5, 6700SM-7, 6700SM-6, 6700SM-5.5, 6700SM-5, 6700SM-8, 6700SM-9, 6700SM-10, 6700SM-11, 6700SM-14, 6700SM-13, 6700SM-12		
6954		
6951		
6956		
6950		
6962		
6966		
6960		
6958		

Juego de llaves de vaso 1/4", 27 piezas
Caja de metal



6722M

41 x 113 x 223 mm	1	6722M

6700SM-4, 6700SM-7, 6700SM-6, 6700SM-5, 6700SM-8, 6700SM-9, 6700SM-10, 6700SM-11, 6700SM-13, 6700SM-14		
6954		
6956		
6950		
6966		
6960, 6962		
6972H		
59S/H3, 59S/H4, 59S/H5, 59S/H6		
59S/PH1, 59S/PH2, 59S/PH3		





















Juego de llaves de vaso 1/4", 27 piezas
Caja de metal



6715GE

 31 x 113 x 223 mm   1 6715GE



















6700SM-4, 6700SM-7, 6700SM-6, 6700SM-5, 6700SM-11, 6700SM-10, 6700SM-9, 6700SM-8, 6700SM-14, 6700SM-13		
6956		
6950RN		
6954		
6966		
6960, 6962		
6972H		
59S/H3, 59S/H4, 59S/H5, 59S/H6		
59S/PH1, 59S/PH2, 59S/PH3		

Juego de llaves de vaso 1/4", 29 piezas
Caja de metal



6715PZ

 41 x 113 x 223 mm   1 6715PZ





















6700SM-4, 6700SM-4.5, 6700SM-7, 6700SM-6, 6700SM-5.5, 6700SM-5, 6700SM-11, 6700SM-10, 6700SM-9, 6700SM-8, 6700SM-12, 6700SM-13		
6956		
6950		
6954		
6962, 6960		
6966		
6709F-4.5, 6709F-5.5, 6709F-8		
6709M-3, 6709M-4, 6709M-5, 6709M-6, 6709M-8		
6709PZ-1, 6709PZ-2, 6709PZ-3		

Juego de llaves de vaso, 29 piezas
Caja de metal



6715GJ

 50 x 113 x 223 mm   1 6715GJ





















6700SM-4, 6700SM-4.5, 6700SM-5.5, 6700SM-5, 6700SM-8, 6700SM-7, 6700SM-6, 6700SM-9, 6700SM-10, 6700SM-11, 6700SM-12, 6700SM-13		
6956		
6962		
6709F-4.5, 6709F-5.5, 6709F-8		
6709M-5, 6709M-6, 6709M-8, 6709M-4, 6709M-3		
6954		
6950		
6966		
6960		
6709PH-1, 6709PH-2, 6709PH-3		

Juego de llaves de vaso 1/4", 33 piezas
Caja de metal



6720NM

 43 x 114 x 351 mm   1 6720NM













6700SM-4.5, 6700SM-7, 6700SM-6, 6700SM-5, 6700SM-5.5, 6700SM-11, 6700SM-10, 6700SM-9, 6700SM-8, 6700SM-13, 6700SM-14, 6700SM-12		
1931M-4, 1931M-4.5, 1931M-9, 1931M-10, 1931M-11, 1931M-14, 1931M-13, 1931M-12, 1931M-7, 1931M-8, 1931M-6, 1931M-5.5, 1931M-5		
6954		
6950		
6956		
221 D		
7372I-3-80		
6966		
6962		
x 6700SM-4		

Juego de llaves de vaso 1/4", 15 piezas, pulgadas
Caja de metal



A6716DZ





 41 x 113 x 223 mm   1 A6716DZ

















A6700DZ-3/16, A6700DZ-7/32, A6700DZ-1/4, A6700DZ-9/32, A6700DZ-5/16, A6700DZ-11/32, A6700DZ-3/8, A6700DZ-7/16, A6700DZ-1/2, A6700DZ-9/16		
6956		
6962		
6966		
6954		
6950		

Juego de vasos 1/4", 18 piezas, pulgadas
Caja de metal



A6718DZ

 41 x 113 x 223 mm  1185   1 A6718DZ

6950		
6951		
6956		
6954		
6958		
6960, 6962		
6966		
A6700DZ-1/2, A6700DZ-1/4, A6700DZ-11/32, A6700DZ-3/16, A6700DZ-3/8, A6700DZ-5/16, A6700DZ-7/16, A6700DZ-7/32, A6700DZ-9/16, A6700DZ-9/32		

Juego de llaves de vaso 1/4", 19 piezas
Caja de metal



6821NZ

50 x 113 x 223 mm	1	6821NZ

6700SZ-1/4, 6700SZ-11/32, 6700SZ-1/2, 6700SZ-3/16, 6700SZ-5/32, 6700SZ-7/32, 6700SZ-9/32, 6700SZ-5/16, 6700SZ-3/8, 6700SZ-7/16, 6700SZ-9/16		
6954		
6958		
6950		
6956		
6960, 6962		
6966		
6951		

Juego de llaves de vaso 1/4", 25 piezas, mm y pulgadas
Caja de metal



6715MZ

40 x 126 x 230 mm	1	6715MZ

6700SM-4.5, 6700SM-5.5, 6700SM-5, 6700SM-6, 6700SM-10, 6700SM-11, 6700SM-9, 6700SM-8, 6700SM-13		
6700SZ-7/32, 6700SZ-3/16, 6700SZ-1/4, 6700SZ-9/32, 6700SZ-5/16, 6700SZ-11/32, 6700SZ-3/8, 6700SZ-7/16, 6700SZ-1/2		
6954		
6950		
6956		
6966		
6962		
6700SM-4		

Juego de llaves de vaso 13 piezas
Vasos hexagonales 6700SM en RAIL-187



6729SM

25 x 55 x 190 mm	1	6729SM

6700SM-4.5, 6700SM-7, 6700SM-6, 6700SM-5.5, 6700SM-5, 6700SM-11, 6700SM-10, 6700SM-9, 6700SM-8, 6700SM-14, 6700SM-13, 6700SM-12, 6700SM-4		
6956		

Juego de llaves de vaso 7 piezas
Vasos hexagonales 6700SZ en rail



6729SZ

25 x 55 x 190 mm	1	6729SZ

6700SZ-1/4, 6700SZ-11/32, 6700SZ-1/2, 6700SZ-3/16, 6700SZ-7/32, 6700SZ-3/8, 6700SZ-7/16		
6956		

Juego de herramientas en caja de metal, mm
Refrigeración



R6725MK

26 x 105 x 175 mm	1	R6725MK

6700SM-7, 6700SM-8, 6700SM-10		
6954		
R6967		
R6810M-6, R6810M-7, R6810M-5, R6810M-8, R6810M-9, R6810M-10		
6966		
R6950		
6962		
R6964A		

Juego de herramientas en caja de metal, pulgadas
Refrigeración



R6725ZK

48 x 115 x 225 mm	1	R6725ZK

6700SZ-1/4, 6700SZ-5/16, 6700SZ-3/8, 6700SZ-7/16, 6700SZ-1/2, 6700SZ-11/32		
6954		
R6967		
R6950		
6962		
R6810M-6		
R6964A		
6966		

Juego de 10 vasos serie larga 1/4"



S0810L

35 x 85 x 160 mm	20	S0810L



Juego de llaves de vaso 1/4", 24 piezas
24 piezas



SL24



35 x 85 x 160 mm

1 SL24

Juego de vasos de 1/4", 37 piezas



SL25L



46 x 130 x 195 mm

10 SL25L

Juego de llaves de vaso 1/4", 29 piezas
29 piezas



S290



70 x 160 x 280 mm

6 S290

Juego de llaves de vaso 1/4", 25 piezas
25 piezas



SL25



35 x 85 x 160 mm
55 x 80 x 165 mm

20 SL25
5 SBSL25

SB- Embalaje en blister

Juego de llaves de vaso 1/4", 16 piezas
16 piezas



S160



70 x 160 x 280 mm

6 S160

Juego de llaves de vaso 1/4", 46 piezas
46 piezas



S460



100 x 215 x 375 mm

6 S460

Juego vasos 1/4", 25 piezas.
En pulgadas.



SL25AF



35 x 85 x 165 mm

1 SL25AF

Juego de llaves de vaso 1/4"
16 piezas, pulgadas



S160AF



70 x 160 x 280 mm

6 S160AF

Juego de llaves de vaso 1/4", 1/2" y llaves
combinadas, 92 piezas



S910



110 x 320 x 375 mm

2 S910

Juego de llaves de vaso 1/4", 1/2"
Llaves combinadas, 94 piezas



S87+7

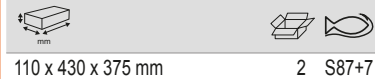

110 x 430 x 375 mm

2 S87+7

Juego llaves de vaso 1/4" y 1/2", 77 piezas



S800



110 x 375 x 430 mm

2 S800

Juego de 8 llaves vaso 1/4" en rail, mm



6708DMB



8

1 6708DMB

A6800DM-10, A6800DM-11,
A6800DM-12, A6800DM-13,
A6800DM-6, A6800DM-7, A6800DM-8,
A6800DM-9

Juego de llaves de vaso 1/4", 1/2"
Llaves mixtas, 106 piezas



S106

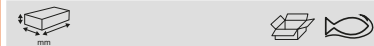

110 x 430 x 375 mm

2 S106

Juego vasos 1/4" y 1/2" y juego llaves combinadas,
138 piezas



S138



110 x 375 x 430 mm

2 S138

Juego de 11 llaves vaso 1/4", en rail



6711MB



11

1 6711MB

A6700DM-10, A6700DM-11,
A6700DM-12, A6700DM-13,
A6700DM-14, A6700DM-5,
A6700DM-5.5, A6700DM-6,
A6700DM-7, A6700DM-8, A6700DM-9

Juego de vasos de 1/4" - 1/2", 41 piezas



S410

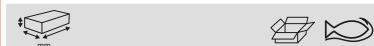

110 x 320 x 375 mm

2 S410

Juego de 13 llaves de vaso 1/4", en rail, mm



6713MH



13

1 6713MH

6700SM-10, 6700SM-11, 6700SM-12,
6700SM-13, 6700SM-14, 6700SM-4,
6700SM-4.5, 6700SM-5, 6700SM-5.5,
6700SM-6, 6700SM-7, 6700SM-8,
6700SM-9

Juego de 6 llaves vaso 1/4" en rail



6706TE



6

1 6706TE

6700TORX-E10, 6700TORX-E4,
6700TORX-E5, 6700TORX-E6,
6700TORX-E7, 6700TORX-E8



3/8"

Vaso hexagonal 3/8", mm
Perfil hexagonal, en mm.



7400SM

6	5	7400SM-6
7	5	7400SM-7
8	5	7400SM-8
9	5	7400SM-9
10	5	7400SM-10
11	5	7400SM-11
12	5	7400SM-12
13	5	7400SM-13
14	5	7400SM-14
15	5	7400SM-15
16	5	7400SM-16
17	5	7400SM-17
18	5	7400SM-18
19	5	7400SM-19
20	5	7400SM-20
21	5	7400SM-21
22	5	7400SM-22

6	1	SB7400SM-6
7	1	SB7400SM-7
8	1	SB7400SM-8
9	1	SB7400SM-9
10	1	SB7400SM-10
11	1	SB7400SM-11
12	1	SB7400SM-12
13	1	SB7400SM-13
14	1	SB7400SM-14
15	1	SB7400SM-15
16	1	SB7400SM-16
17	1	SB7400SM-17
18	1	SB7400SM-18
19	1	SB7400SM-19
20	1	SB7400SM-20
21	1	SB7400SM-21
22	1	SB7400SM-22

SB: Clip para colgar

Vaso bihexagonal 3/8", mm
Paredes finas



A7400DM

6	5	A7400DM-6
7	5	A7400DM-7

8	5	A7400DM-8
9	5	A7400DM-9
10	5	A7400DM-10
11	5	A7400DM-11
12	5	A7400DM-12
13	5	A7400DM-13
14	5	A7400DM-14
15	5	A7400DM-15
16	5	A7400DM-16
17	5	A7400DM-17
18	5	A7400DM-18
19	5	A7400DM-19
20	5	A7400DM-20
21	5	A7400DM-21
22	5	A7400DM-22
24	5	A7400DM-24

6	1	SBA7400DM-6
7	1	SBA7400DM-7
8	1	SBA7400DM-8
9	1	SBA7400DM-9
10	1	SBA7400DM-10
11	1	SBA7400DM-11
12	1	SBA7400DM-12
13	1	SBA7400DM-13
14	1	SBA7400DM-14
15	1	SBA7400DM-15
16	1	SBA7400DM-16
17	1	SBA7400DM-17
18	1	SBA7400DM-18
19	1	SBA7400DM-19
20	1	SBA7400DM-20
21	1	SBA7400DM-21
22	1	SBA7400DM-22

SB: Clip para colgar

Vaso hexagonal 3/8", pulgadas
Perfil hexagonal, inches medidas



7400SZ

1/4" in	1	7400SZ-1/4
5/16" in	1	7400SZ-5/16
11/32" in	1	7400SZ-11/32
3/8" in	1	7400SZ-3/8
7/16" in	1	7400SZ-7/16
1/2" in	1	7400SZ-1/2
9/16" in	1	7400SZ-9/16
5/8" in	1	7400SZ-5/8
11/16" in	1	7400SZ-11/16
3/4" in	1	7400SZ-3/4
13/16" in	1	7400SZ-13/16
7/8" in	1	7400SZ-7/8

Vaso bihexagonal 3/8", pulgadas
Perfil bi-hexagonal, en pulgadas. Paredes finas.



A7400DZ

1/4	5	A7400DZ-1/4
5/16	5	A7400DZ-5/16
3/8	5	A7400DZ-3/8
7/16	5	A7400DZ-7/16
1/2	5	A7400DZ-1/2
17/32	5	A7400DZ-17/32
9/16	5	A7400DZ-9/16
19/32	5	A7400DZ-19/32
5/8	5	A7400DZ-5/8
11/16	5	A7400DZ-11/16
3/4	5	A7400DZ-3/4
13/16	5	A7400DZ-13/16
7/8	5	A7400DZ-7/8

1/4	1	SBA7400DZ-1/4
5/16	1	SBA7400DZ-5/16
3/8	1	SBA7400DZ-3/8
7/16	1	SBA7400DZ-7/16
1/2	1	SBA7400DZ-1/2
17/32	1	SBA7400DZ-17/32
9/16	1	SBA7400DZ-9/16
19/32	1	SBA7400DZ-19/32
5/8	1	SBA7400DZ-5/8
11/16	1	SBA7400DZ-11/16
3/4	1	SBA7400DZ-3/4
13/16	1	SBA7400DZ-13/16
7/8	1	SBA7400DZ-7/8

SB: Clip para colgar

Vaso articulado bihexagonal 3/8", pulgadas
Perfil bi-hexagonal, en pulgadas. Paredes finas.



A7410DZ

5/16	1	A7410DZ-5/16
3/8	1	A7410DZ-3/8
7/16	1	A7410DZ-7/16
1/2	1	A7410DZ-1/2
9/16	1	A7410DZ-9/16
5/8	1	A7410DZ-5/8
11/16	1	A7410DZ-11/16
3/4	1	A7410DZ-3/4

Vaso bihexagonal 3/8" serie larga, mm
Perfil bi-hexagonal, en mm.



A7402DM

7	1	A7402DM-7		
8	1	A7402DM-8		
9	1	A7402DM-9		
10	1	A7402DM-10		
11	1	A7402DM-11		
12	1	A7402DM-12		
13	1	A7402DM-13		
14	1	A7402DM-14		
15	1	A7402DM-15		
16	1	A7402DM-16		
17	1	A7402DM-17		
18	1	A7402DM-18		
19	1	A7402DM-19		
2	1	A7402DM-21		
<hr/>				
7	10	SBA7402DM-7		
8	10	SBA7402DM-8		
9	10	SBA7402DM-9		
10	10	SBA7402DM-10		
11	10	SBA7402DM-11		
12	10	SBA7402DM-12		
13	10	SBA7402DM-13		
14	10	SBA7402DM-14		
15	1	SBA7402DM-15		
16	10	SBA7402DM-16		
17	10	SBA7402DM-17		
18	10	SBA7402DM-18		
19	10	SBA7402DM-19		

SB: Clip para colgar

Vaso bihexagonal 3/8" serie larga, pulgadas
Perfil bi-hexagonal, en pulgadas.



A7402DZ

1/4	1	A7402DZ-1/4		
5/16	1	A7402DZ-5/16		
3/8	1	A7402DZ-3/8		
7/16	1	A7402DZ-7/16		
1/2	1	A7402DZ-1/2		
9/16	1	A7402DZ-9/16		
19/32	1	A7402DZ-19/32		
5/8	1	A7402DZ-5/8		
11/16	1	A7402DZ-11/16		
3/4	1	A7402DZ-3/4		
13/16	1	A7402DZ-13/16		

7/8	1	A7402DZ-7/8		
1/4	10	SBA7402DZ-1/4		
5/16	10	SBA7402DZ-5/16		
3/8	10	SBA7402DZ-3/8		
7/16	10	SBA7402DZ-7/16		
1/2	10	SBA7402DZ-1/2		
9/16	10	SBA7402DZ-9/16		
19/32	10	SBA7402DZ-19/32		
5/8	10	SBA7402DZ-5/8		
11/16	10	SBA7402DZ-11/16		
3/4	10	SBA7402DZ-3/4		
13/16	10	SBA7402DZ-13/16		
7/8	10	SBA7402DZ-7/8		

SB: Clip para colgar

Vaso TORX® hembra 3/8"



7400TORX-E

E8	5	7400TORX-E8		
E10	5	7400TORX-E10		
E11	5	7400TORX-E11		
E12	5	7400TORX-E12		
E14	5	7400TORX-E14		
E16	5	7400TORX-E16		
E18	5	7400TORX-E18		
<hr/>				
E8	1	SB7400TORX-E8		
E10	1	SB7400TORX-E10		
E11	1	SB7400TORX-E11		
E12	1	SB7400TORX-E12		
E14	1	SB7400TORX-E14		
E16	1	SB7400TORX-E16		
E18	1	SB7400TORX-E18		

SB: Clip para colgar

Berbiquí 3/8" con mango de acero giratorio



7752

435	1	7752		

Mango articulado 3/8"



7758

250	1	7758		
235	1	SB7758		

SB: Clip para colgar

Mango articulado 3/8"
Embalaje en blister



S705

246	1	SBS705		

Mango corredizo en T 3/8"



7754

160	1	7754		
160	8	SB7754		

SB: Clip para colgar



Destornillador portavasos 3/8"
Hembra cuadradillo de 3/8" en el mango



7757

150	1 7757
150	1 SB7757

SB: Clip para colgar

Alargadera de 3/8" con moleteado



776EX

26	1 776EX-01
76	1 776EX-03
101	1 776EX-04
150	1 776EX-06
200	1 776EX-08
275	1 776EX-11

Articulación universal 3/8", funcionamiento fluido



7768

45	1 7768

Alargadera de 3/8"



7760-7761-7762

75	1 7760
127	1 7761
250	1 7762
73.5	1 SB7760
127	1 SB7761
252	1 SB7762

SB: Clip para colgar

Alargadera flexible de 3/8"

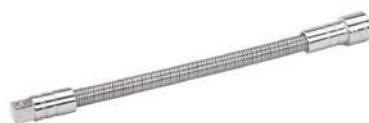

7759

204	1 7759
208	1 SB7759

SB: Clip para colgar

Reductor de entrada 3/8" y salida 1/4"



7764

3/8	1/4	1 7764
3/8	1/4	1 SB7764

SB: Clip para colgar

Alargadera angular 3/8"



7760-W - 7761-W

75	1 7760-W
150	1 7761-W

SB: Clip para colgar

Articulación universal 3/8"



7766

51.5	1 7766
51.5	1 SB7766

SB: Clip para colgar

Amplificador de entrada 3/8" a salida 1/2"



8164-1/2

3/8"	1/2"	1 8164-1/2

Aumentador magnético de 3/8" a 1/2"
Con imán en el disco



8167

3/8	1/2	1	8167

Llave de carraca reversible ERGO®
72 dientes

ergo®



7755-3/8

215	72	1	7755-3/8
215	72	1	SB7755-3/8

SB- Clip para colgar

Llave de carraca reversible, 3/8"



7750RN

206	72	1	7750RN
206	72	1	SB7750RN

SB- Clip para colgar

Adaptador 3/8" para puntas 5/16"



7106J

5/16 in	1	7106J

Llave de carraca 3/8" cabeza delgada 72 dientes
Ángulo de acción 5°



7750SL

204	72	1	7750SL

Llave de carraca reversible 3/8"
Embalaje en blister



SBS750

200	60	10	SBS750

Railes y clips para vasos 3/8"



C3/8

19	25	CLIPS-3/8

Llave de carraca reversible 3/8"
80 dientes / Ángulo de acción de 4.5°



7750

207	80	1	7750
207 mm	80	1	SB7750

Carraca 3/8" con cabeza giratoria



8120-3/8

223 mm	72	10	8120-3/8



Llave de carraca articulada 3/8" reversible



7710

278	60	1	7710

Vaso con punta recta 3/8"



7409F

6.4	5	7409F-6.5
7.9	5	7409F-8
9.5	5	7409F-10
6.4	1	SB7409F-6.5
7.9	1	SB7409F-8
9.5	1	SB7409F-10

SB: Clip para colgar

Vaso con punta Phillips 3/8"



7409PH

1	5	7409PH-1
2	5	7409PH-2
3	5	7409PH-3
1	1	SB7409PH-1
2	1	SB7409PH-2
3	1	SB7409PH-3

SB: Clip para colgar

Vaso con punta TORX® 3/8"



7409TORX

T20	5	7409TORX-T20
T25	5	7409TORX-T25
T27	5	7409TORX-T27
T30	5	7409TORX-T30
T40	5	7409TORX-T40
T45	5	7409TORX-T45
T50	5	7409TORX-T50
T20	1	SB7409TORX-T20
T25	1	SB7409TORX-T25
T27	1	SB7409TORX-T27
T30	1	SB7409TORX-T30
T40	1	SB7409TORX-T40
T45	1	SB7409TORX-T45
T50	1	SB7409TORX-T50

SB: Clip para colgar

Vaso con punta TORX® invariable, 3/8"



7409TORX-R

TR 27	5	7409TORX-R-T27
TR 30	5	7409TORX-R-T30
TR 40	5	7409TORX-R-T40
TR 45	5	7409TORX-R-T45
TR 50	5	7409TORX-R-T50
TR 27	1	SB7409TORX-R-T27
TR 30	1	SB7409TORX-R-T30
TR 40	1	SB7409TORX-R-T40
TR 45	1	SB7409TORX-R-T45
TR 50	1	SB7409TORX-R-T50

SB: Clip para colgar

Juego de 5 vasos con punta 3/8" 7409TORX Inviolables en RAIL-187



7409TORX-TRR/

5	25 x 55 x 190 mm	1	7409TORX-TRR/S5

7409TORX-R-T27, 7409TORX-R-T30, 7409TORX-R-T40, 7409TORX-R-T45, 7409TORX-R-T50

Vaso con punta TORX® serie larga 3/8"



7409TORX-L

T25	5	7409TORX-T25-L
T30	5	7409TORX-T30-L
T40	5	7409TORX-T40-L
T45	5	7409TORX-T45-L
T50	5	7409TORX-T50-L
T25	1	SB7409TORX-T25-L
T30	1	SB7409TORX-T30-L
T40	1	SB7409TORX-T40-L
T45	1	SB7409TORX-T45-L
T50	1	SB7409TORX-T50-L



SB: Clip para colgar

Vaso con punta hexagonal cuadrado 3/8", mm En métrica.



7409M

3	5	7409M-3
4	5	7409M-4
5	5	7409M-5
6	5	7409M-6

				
7	5	7409M-7		
8	5	7409M-8		
10	5	7409M-10		
3	1	SB7409M-3		
4	1	SB7409M-4		
5	1	SB7409M-5		
6	1	SB7409M-6		
7	1	SB7409M-7		
8	1	SB7409M-8		
10	1	SB7409M-10		

SB: Clip para colgar

Vaso con punta hexagonal con bola 3/8"



7409BH

				
4	5	7409BH-4		
5	1	7409BH-5		
6	5	7409BH-6		
8	5	7409BH-8		
10	5	7409BH-10		
4	1	SB7409BH-4		
5	1	SB7409BH-5		
6	1	SB7409BH-6		
8	1	SB7409BH-8		
10	1	SB7409BH-10		

SB: Clip para colgar

Portapuntas cuadradillos de 3/8", para puntas hexagonales, pulgadas
En pulgadas



7409Z

			
1/8 in	47 mm	1	7409Z-1/8
5/32 in	47 mm	1	7409Z-5/32
3/16 in	47 mm	1	7409Z-3/16
7/32 in	47 mm	1	7409Z-7/32
1/4 in	47 mm	1	7409Z-1/4
3/8 in	50.5 mm	1	7409Z-3/8

Juego de vasos con punta hexagonal 3/8"
Ref 7409M sobre rail-187



7409MR/

		
7	25 x 55 x 190 mm	1 7409MR/S7

Adaptador de carraca reversible 3/8"



7751

			
55 mm	175	10	7751

Kit de reparación para 7755-3/8



7755-SO/1

		
6	7755-3/8	1 7755-SO/1

Kit de reparación para carraca 3/8 7750





7750-SPARE

		
11	7750	1 7750-SPARE

Kit de reparación para carraca 3/8 7750RN



7750RN-SPARE

		
6	7750RN	1 7750RN-SPARE

Kit de reparación para llave de carraca 3/8" 7710



7710-SO/1

		
8	7710	1 7710-SO/1

Kit de reparación para carraca cabeza delgada 3/8" 7750SL



7750SL-SPARE

		
12	7750SL	1 7750SL-SPARE







Juego de vasos 3/8", 13 piezas



7420RE

 50 x 115 x 312 mm   1 7420RE





- | | |
|--|---|
| 7755-3/8 |  |
| 7400SM-11, 7400SM-10, 7400SM-8, 7400SM-17, 7400SM-18, 7400SM-19, 7400SM-15, 7400SM-14, 7400SM-13, 7400SM-12, 7400SM-16 |   |
| 7761 |  |

Juego de vasos 3/8", 15 piezas



7440ME

 57 x 205 x 278 mm   1 7440ME







- | | |
|--|---|
| 7400SM-11, 7400SM-10, 7400SM-15, 7400SM-14, 7400SM-13, 7400SM-12, 7400SM-7, 7400SM-6, 7400SM-9, 7400SM-8, 7400SM-17, 7400SM-19 |   |
| 7758 |  |
| 7755-3/8 |  |
| 7761 |  |

Juego de vasos 3/8", 17 piezas



7430GE

 50 x 115 x 312 mm   1 7430GE









- | | |
|--|--|
| 7754 |  |
| 7762 |  |
| 7400SM-7, 7400SM-6, 7400SM-11, 7400SM-10, 7400SM-15, 7400SM-14, 7400SM-13, 7400SM-12, 7400SM-9, 7400SM-8, 7400SM-17, 7400SM-19 |   |
| 7761 |  |
| 7766 |  |
| 7755-3/8 |  |

Juego de vasos 3/8" 22 piezas, Bihex.,mm



A7435DME

 40 x 150 x 500 mm   1 A7435DME

- | | |
|---|--|
| A7400DM-12, A7400DM-13, A7400DM-10, A7400DM-11, A7400DM-9, A7400DM-16, A7400DM-17, A7400DM-14, A7400DM-15, A7400DM-22, A7400DM-20, A7400DM-21, A7400DM-18, A7400DM-19 |   |
| 7755-3/8 |  |
| 7754 |  |
| 7760, 7762 |  |
| 7758 |  |
| 7752 |  |
| 7761 |  |
| 7766 |  |





Juego de vasos 3/8", 14 piezas, Bihex., pulgadas



A7440DZE

 50 x 115 x 312 mm   1 A7440DZE

Caja de metal





- | | |
|--|---|
| A7400DZ-1/4, A7400DZ-5/16, A7400DZ-3/8, A7400DZ-7/16, A7400DZ-1/2, A7400DZ-9/16, A7400DZ-3/4, A7400DZ-13/16, A7400DZ-7/8, A7400DZ-5/8, A7400DZ-11/16 |   |
| 7755-3/8 |  |
| 7758 |  |
| 7761 |  |

Juego de vasos de 3/8", 17 piezas, Bihex., mm



A7440DME

 50 x 115 x 312 mm   1 A7440DME

- | | |
|---|---|
| 7755-3/8 |  |
| 7758 |  |
| 7761 |  |
| A7400DM-10, A7400DM-11, A7400DM-12, A7400DM-13, A7400DM-14, A7400DM-15, A7400DM-16, A7400DM-17, A7400DM-18, A7400DM-19, A7400DM-20, A7400DM-21, A7400DM-22, A7400DM-9 |   |

Juego de llaves de vaso 3/8", 22 piezas



7422MBR

60 x 220 x 280 mm 1 7422MBR

- A7400DM-6, A7400DM-7, A7400DM-8, A7400DM-9, A7400DM-10, A7400DM-11, A7400DM-12, A7400DM-13, A7400DM-14, A7400DM-15, A7400DM-16, A7400DM-17, A7400DM-18, A7400DM-19, A7400DM-20, A7400DM-21, A7400DM-22
- 7750RN
- 7760, 7762
- 7754
- 7766

Juego de llaves de vaso 3/8", 22 piezas



7422MHR

50 x 160 x 350 mm 1 7422MHR

- 7400SM-6, 7400SM-7, 7400SM-8, 7400SM-9, 7400SM-10, 7400SM-11, 7400SM-12, 7400SM-13, 7400SM-14, 7400SM-15, 7400SM-16, 7400SM-17, 7400SM-18, 7400SM-19, 7400SM-20, 7400SM-21, 7400SM-22
- 7750RN
- 7760, 7762
- 7754
- 7766

Juego de vasos 3/8", 20`piezas, Bihex., pulgadas



A7535DZE

165 x 500 x 45 mm 1 A7535DZE

A7400DZ-1/2, A7400DZ-17/32, A7400DZ-1/4, A7400DZ-3/4, A7400DZ-13/16, A7400DZ-19/32, A7400DZ-11/16, A7400DZ-3/8, A7400DZ-7/16, A7400DZ-5/16, A7400DZ-7/8, A7400DZ-9/16, A7400DZ-5/8

- 7755-3/8
- 7754
- 7760
- 7766
- 7758
- 7752
- 7762

Juego de llaves de vaso 3/8", 31 piezas, Bihex., mm



7429JDE

38 x 150 x 490 mm 1 7429JDE

- A7400DM-6, A7400DM-7, A7400DM-8, A7400DM-9, A7400DM-10, A7400DM-11, A7400DM-12, A7400DM-13, A7400DM-14, A7400DM-15, A7400DM-16, A7400DM-17, A7400DM-18, A7400DM-19, A7400DM-20, A7400DM-21, A7400DM-22
- 7755-3/8
- 7754
- 7760
- 7757
- 7407H
- 7766
- 7409PH-1, 7409PH-2, 7409PH-3
- 7409F-6.5, 7409F-8
- 7409M-3, 7409M-4, 7409M-5, 7409M-6, 7409M-8

Juego de 14 vasos 3/8" serie larga



S1214L

49 x 152 x 280 mm 10 S1214L

Juego de llaves de vaso 1/4" y 3/8", 33 piezas 34 piezas



S330

70 x 160 x 280 mm 6 S330

Juego de vasos de 3/8 y 1/4" 34 piezas, pulgadas



S330AF

70 x 160 x 280 mm 6 S330AF



Juego de llaves de vaso 1/4" y 3/8", 53 piezas



S330L

100 x 215 x 375 mm	4	S330L

Juego vasos 3/8", 38 piezas



S380

100 x 215 x 375 mm	4	S380

Juego de vasos con accionamiento exterior y carraca pasante, 14 piezas



S140T

65 x 160 x 280 mm	1	S140T

Juego de llave de carraca con cuadrado pasante, 3 piezas



S140T-R

121 x 280 x 220 mm	10	S140T-R

Carraca 72 dientes, Adaptador 19mm-3/4" para cuadrado 3/8", Adaptador 19mm-3/4" para cuadrado 1/2"

1RMA-19-1/2-SQ

Juego de vasos pasantes, 53 piezas



S530T

90 x 205 x 370 mm	4	S530T

Juego de llaves de vaso 3/8" con cabeza delgada, 34 piezas



SL34

280 mm	160 mm	6	SL34

Juego de llaves de vaso 3/8" 12 piezas, en rail



7400SR/

12	35 x 220 x 25 mm	1	7400SR/S12

7400SM-10, 7400SM-11, 7400SM-12, 7400SM-13, 7400SM-14, 7400SM-15, 7400SM-16, 7400SM-17, 7400SM-18, 7400SM-19, 7400SM-8, 7400SM-9

Juego de 9 llaves de vaso 3/8" en rail, mm



7409MB

9	1	7409MB

A7400DM-10, A7400DM-11, A7400DM-13, A7400DM-15, A7400DM-17, A7400DM-19, A7400DM-22, A7400DM-7, A7400DM-8

Juego de 8 llaves de vaso 3/8" en rail, mm



7408MD

8	1	7408MD

A7402DM-10, A7402DM-11, A7402DM-12, A7402DM-13, A7402DM-14, A7402DM-17, A7402DM-19, A7402DM-8

Juego de 7 vasos 3/8"
En rail-264



7400TORX-ER/

		
7	25 x 55 x 190 mm	1 7400TORX-ER/S7



7400TORX-E10, 7400TORX-E11,
7400TORX-E12, 7400TORX-E14,
7400TORX-E16, 7400TORX-E18,
7400TORX-E8



1/2"

Vaso de 1/2" hexagonal, mm
Perfil hexagonal, en mm.



7800SM

	
8	1 7800SM-8
9	1 7800SM-9
10	1 7800SM-10
11	1 7800SM-11
12	1 7800SM-12
13	1 7800SM-13
14	1 7800SM-14
15	1 7800SM-15
16	1 7800SM-16
17	1 7800SM-17
18	1 7800SM-18
19	1 7800SM-19
20	1 7800SM-20
21	1 7800SM-21
22	1 7800SM-22
23	1 7800SM-23



	
24	1 7800SM-24
25	1 7800SM-25
26	1 7800SM-26
27	1 7800SM-27
28	1 7800SM-28
29	1 7800SM-29
30	1 7800SM-30
32	1 7800SM-32
33	1 7800SM-33
34	1 7800SM-34
36	1 7800SM-36
8	1 SB7800SM-8
9	1 SB7800SM-9
10	1 SB7800SM-10
11	1 SB7800SM-11
12	1 SB7800SM-12
13	1 SB7800SM-13
14	1 SB7800SM-14
15	1 SB7800SM-15
16	1 SB7800SM-16
17	1 SB7800SM-17
18	1 SB7800SM-18
19	1 SB7800SM-19
21	1 SB7800SM-20
21	1 SB7800SM-21
22	1 SB7800SM-22
23	1 SB7800SM-23
24	1 SB7800SM-24
25	1 SB7800SM-25
26	1 SB7800SM-26
27	1 SB7800SM-27
28	1 SB7800SM-28
29	1 SB7800SM-29
30	1 SB7800SM-30
32	1 SB7800SM-32
33 mm	1 SB7800SM-33
34	1 SB7800SM-34
36	1 SB7800SM-36



SB: Clip para colgar

Vasos de 1/2" serie larga hex, mm
Perfil hexagonal, en mm.



7805SM

	
10	1 7805SM-10
12	1 7805SM-12
13	1 7805SM-13
14	1 7805SM-14
15	1 7805SM-15
16	1 7805SM-16



	
17	1 7805SM-17
18	1 7805SM-18
19	1 7805SM-19
20 mm	1 7805SM-20
21	1 7805SM-21
22	1 7805SM-22
23	1 7805SM-23
24	1 7805SM-24
25 mm	1 7805SM-25
26	1 7805SM-26
27	1 7805SM-27
28 mm	1 7805SM-28
29 mm	1 7805SM-29
30	1 7805SM-30
32	1 7805SM-32
10	1 SB7805SM-10
12	1 SB7805SM-12
13	1 SB7805SM-13
14	1 SB7805SM-14
15	1 SB7805SM-15
16	1 SB7805SM-16
17	1 SB7805SM-17
18	1 SB7805SM-18
19	1 SB7805SM-19
21	1 SB7805SM-21
22	1 SB7805SM-22
23	1 SB7805SM-23
24	1 SB7805SM-24
26	1 SB7805SM-26
27	1 SB7805SM-27
30	1 SB7805SM-30
32	1 SB7805SM-32

SB: Clip para colgar

Vaso 1/2" cuadrado, serie larga
Perfil hexagonal, en pulgadas



7805SZ



	
1.3/16 in	1 7805SZ-1.3/16
1.1/4 in	1 7805SZ-1.1/4
1.5/16 in	1 7805SZ-1.5/16
1.3/8 in	1 7805SZ-1.3/8
1.7/16 in	1 7805SZ-1.7/16
1.1/2 in	1 7805SZ-1.1/2



Vaso de 1/2" bihex, mm
Perfil bi-hexagonal, en mm.



7800DM



 	
8	1 7800DM-8
9	1 7800DM-9
10	1 7800DM-10
11	1 7800DM-11
12	1 7800DM-12
13	1 7800DM-13
14	1 7800DM-14
15	1 7800DM-15
16	1 7800DM-16
17	1 7800DM-17
18	1 7800DM-18
19	1 7800DM-19
20	1 7800DM-20
21	1 7800DM-21
22	1 7800DM-22
23	1 7800DM-23
24	1 7800DM-24
25	1 7800DM-25
26	1 7800DM-26
27	1 7800DM-27
28	1 7800DM-28
29	1 7800DM-29
30	1 7800DM-30
32	1 7800DM-32
31 mm	1 7800DM-33
31	1 7800DM-34
36	1 7800DM-36
<hr/>	
8	1 SB7800DM-8
9	1 SB7800DM-9
10	1 SB7800DM-10
11	1 SB7800DM-11
12	1 SB7800DM-12
13	1 SB7800DM-13
14	1 SB7800DM-14
15	1 SB7800DM-15
16	1 SB7800DM-16
17	1 SB7800DM-17
18	1 SB7800DM-18
19	1 SB7800DM-19
21	1 SB7800DM-20
21	1 SB7800DM-21
22	1 SB7800DM-22
23	1 SB7800DM-23
24	1 SB7800DM-24
25	1 SB7800DM-25
26	1 SB7800DM-26
27	1 SB7800DM-27
28	1 SB7800DM-28
29	1 SB7800DM-29
30	1 SB7800DM-30
32	1 SB7800DM-32
33	1 SB7800DM-33
34 mm	1 SB7800DM-34
36	1 SB7800DM-36

SB-Clip para colgar

Vasos de 1/2" bihexagonal, pulgadas
Perfil bi-hexagonal, en pulgadas.



7800DZ



 	
3/8	1 7800DZ-3/8
7/16	1 7800DZ-7/16
1/2	1 7800DZ-1/2
9/16	1 7800DZ-9/16
19/32	1 7800DZ-19/32
5/8	1 7800DZ-5/8
11/16	1 7800DZ-11/16
3/4	1 7800DZ-3/4
25/32	1 7800DZ-25/32
13/16	1 7800DZ-13/16
7/8	1 7800DZ-7/8
15/16	1 7800DZ-15/16
1	1 7800DZ-1
1 1/16	1 7800DZ-1.1/16
1 1/8	1 7800DZ-1.1/8
1 3/16	1 7800DZ-1.3/16
1 1/4	1 7800DZ-1.1/4
1.5/16 in	1 7800DZ-1.5/16
<hr/>	
3/8	1 SB7800DZ-3/8
7/16	1 SB7800DZ-7/16
1/2	1 SB7800DZ-1/2
9/16	1 SB7800DZ-9/16
19/32	1 SB7800DZ-19/32
5/8	1 SB7800DZ-5/8
11/16	1 SB7800DZ-11/16
3/4	1 SB7800DZ-3/4
25/32	1 SB7800DZ-25/32
13/16	1 SB7800DZ-13/16
7/8	1 SB7800DZ-7/8
15/16	1 SB7800DZ-15/16
1	1 SB7800DZ-1
1.1/16	1 SB7800DZ-1.1/16
1.1/8	1 SB7800DZ-1.1/8
1.3/16	1 SB7800DZ-1.3/16
1.1/4	1 SB7800DZ-1.1/4
1 5/16 in	1 SB7800DZ-1.5/16



SB: Clip para colgar

Vaso de 1/2" bihexagonal, mm
Perfil bi-hexagonal, en mm.



7805DM

 	
10	1 7805DM-10
12	1 7805DM-12
13	1 7805DM-13



 	
14	1 7805DM-14
15	1 7805DM-15
16	1 7805DM-16
17	1 7805DM-17
18	1 7805DM-18
19	1 7805DM-19
21	1 7805DM-21
22	1 7805DM-22
19 mm	1 7805DM-23
24	1 7805DM-24
26	1 7805DM-26
27	1 7805DM-27
30	1 7805DM-30
32	1 7805DM-32
<hr/>	
10	1 SB7805DM-10
12	1 SB7805DM-12
13	1 SB7805DM-13
14	1 SB7805DM-14
15	1 SB7805DM-15
16	1 SB7805DM-16
17	1 SB7805DM-17
18	1 SB7805DM-18
19	1 SB7805DM-19
21	1 SB7805DM-21
22	1 SB7805DM-22
23 mm	1 SB7805DM-23
24	1 SB7805DM-24
26	1 SB7805DM-26
27	1 SB7805DM-27
30	1 SB7805DM-30
32	1 SB7805DM-32

SB: Clip para colgar

Vaso 1/2" cuadrado, serie larga
Perfil bi-hexagonal, en pulgadas



7805DZ

 	
5/8 in	1 7805DZ-5/8
11/16 in	1 7805DZ-11/16
3/4 in	1 7805DZ-3/4
13/16 in	1 7805DZ-13/16
7/8 in	1 7805DZ-7/8
15/16 in	1 7805DZ-15/16
1 in	1 7805DZ-1
1.1/16 in	1 7805DZ-1.1/16
1.1/8 in	1 7805DZ-1.1/8
1.13/16 in	1 7805DZ-1.3/16
1.1/4 in	1 7805DZ-1.1/4
1.5/16 in	1 7805DZ-1.5/16
1.3/8 in	1 7805DZ-1.3/8
1.7/16 in	1 7805DZ-1.7/16
1.1/2 in	1 7805DZ-1.1/2

Vaso TORX® hembra, cuadrado 1/2"
Para tornillos TORX®



7800TORX-E

E8	1	7800TORX-E8
E10	1	7800TORX-E10
E11	1	7800TORX-E11
E12	1	7800TORX-E12
E14	1	7800TORX-E14
E16	1	7800TORX-E16
E18	1	7800TORX-E18
E20	1	7800TORX-E20
E24	1	7800TORX-E24
E8	1	SB7800TORX-E8
E10	1	SB7800TORX-E10
E11	1	SB7800TORX-E11
E12	1	SB7800TORX-E12
E14	1	SB7800TORX-E14
E16	1	SB7800TORX-E16
E18	1	SB7800TORX-E18
E20	1	SB7800TORX-E20
E24	1	SB7800TORX-E24

SB: Clip para colgar

Berbiquí 1/2", con mango de acero giratorio



8152-1/2

L	
425	1 8152-1/2

Mango articulado de 1/2"



8158-1/2

L	
257	1 8156-1/2
390	1 8158-1/2
600 mm	1 8169-1/2
900 mm	1 8170-1/2
375	1 SB8158-1/2

SB: Clip para colgar

Mango articulado de 1/2"
En blister



S87

L	
270	1 SBS87S
390	1 SBS87

Mango acodado 1/2"



8167-1/2

L	
210	1 8167-1/2

Mango corredizo en T, 1/2"



8154-1/2

L	
283	1 8154-1/2
283 mm	1 SB8154-1/2

SB: Clip para colgar

Alargadera de 1/2"



8159/8160/8162

L	
88	1 8159-1/2
125	1 8160-1/2
250	1 8162-1/2
88	1 SB8159-1/2

L	
125	1 SB8160-1/2
250	1 SB8162-1/2

SB: Clip para colgar

Alargadera angular 1/2"



8159-W - 8162-W

L	
150	1 8159-W
125	1 8160-W
250	10 8162-W

Alargadera con bloqueo 1/2"



8160-B

L	
125	1 8160-B

Articulación universal de 1/2"



8166-1/2

L	
72	1 8166-1/2
68	1 SB8166-1/2

SB: Clip para colgar



Articulación universal de 1/2", funcionamiento fluido



8168



62



1 8168

Amplificador plano de 1/2" a 3/4"
Con imán en el disco



8967



1/2



3/4



1 8967

Kit de repuestos para mango articulado 1/2"
8170-1/2



SP120XL



55



1 SP120XL

Reductor de entrada 1/2" a salida 3/8"



8165-1/2



1/2



3/8



1 8165-1/2

Adaptador de 1/2" para puntas 5/16"



7106S



5/16 in



1 7106S

Regletas y clips 1/2"



C1/2



19



25 CLIPS-1/2

Llave combinada escalonada
5 escalones diferentes: 3/8"-7/16"-1/2"-3/4"-1"



8195-key



140



50 8195-KEY

Para usar con 8195-R

Adaptador 1/2" para puntas 5/16"



7809HL



5/16 in



1 7809HL

Vaso con punta recta cuadrado 1/2"



7809F



0.8



8



5 7809F-8

1

10

5 7809F-10



Aumentador de entrada 1/2" a salida 3/4"



8964



1/2



3/4



1 8964

Kit de repuestos para mango articulado 1/2"
8169-1/2
Y 8156-1/2, 8158-1/2 hasta 2016. Roscado



SP120



75



1 SP120

Vaso con punta Phillips cuadrado 1/2"



7809PH



2

3

4



1 7809PH-2

1 7809PH-3

1 7809PH-4



Vaso con punta Pozidriv cuadrado 1/2"



7809PZ

2	1	7809PZ-2
3	1	7809PZ-3

Vaso con punta TORX® cuadrado 1/2"



7809TORX

T20	1	7809TORX-T20
T25	1	7809TORX-T25
T27	1	7809TORX-T27
T30	1	7809TORX-T30
T40	1	7809TORX-T40
T45	1	7809TORX-T45
T50	1	7809TORX-T50
T55	1	7809TORX-T55
T60	1	7809TORX-T60
T20	1	SB7809TORX-T20
T25	1	SB7809TORX-T25
T27	1	SB7809TORX-T27
T30	1	SB7809TORX-T30
T40	1	SB7809TORX-T40
T45	1	SB7809TORX-T45
T50	1	SB7809TORX-T50
T55	1	SB7809TORX-T55
T60	1	SB7809TORX-T60

Vasos largos con punta TORX®, cuadrado 1/2"



7809TORX

T40	82	5	7809TORX-T40-120
T45	80	1	7809TORX-T45-120

T50	62	5	7809TORX-T50-100
T55	102	5	7809TORX-T55-140
T70	102	5	7809TORX-T70-140

Juego de 9 vasos con punta TORX® 1/2" en rail



7809TO

9	1	7809TO
---	---	--------

7809TORX-T20, 7809TORX-T25, 7809TORX-T27, 7809TORX-T30, 7809TORX-T40, 7809TORX-T45, 7809TORX-T50, 7809TORX-T55, 7809TORX-T60

Vaso con punta hexagonal cuadrado 1/2", mm
En métrica.



7809M

4	1	7809M-4
5	1	7809M-5
6	1	7809M-6
7	1	7809M-7
8	1	7809M-8
9	1	7809M-9
10	1	7809M-10
12	1	7809M-12
14	1	7809M-14
17	1	7809M-17
19	1	7809M-19
4 mm	1	SB7809M-4
5	1	SB7809M-5
6	1	SB7809M-6
7	1	SB7809M-7
8	1	SB7809M-8
9	1	SB7809M-9
10	1	SB7809M-10
12	1	SB7809M-12
14	1	SB7809M-14
17	1	SB7809M-17
19	1	SB7809M-19

Juego de 8 vasos con punta hexagonal 1/2" en rail, mm



7808HM

8	1	7808HM
---	---	--------

7809M-10, 7809M-12, 7809M-14, 7809M-4, 7809M-5, 7809M-6, 7809M-7, 7809M-8

Vaso con punta hexagonal cuadrado 1/2", pulgadas
En pulgadas.



7809Z

3/16	1	7809Z-3/16
1/4	1	7809Z-1/4
5/16	1	7809Z-5/16
3/8	1	7809Z-3/8
7/16	1	7809Z-7/16
1/2	1	7809Z-1/2
17/32	1	7809Z-17/32
9/16	1	7809Z-9/16
19/32	1	7809Z-19/32
5/8	1	7809Z-5/8

Vaso con punta XZN cuadrado 1/2"
En métrica



7809XZN

6	1	7809XZN-6
8	1	7809XZN-8
8	1	7809XZN-8-100
10	1	7809XZN-10
10	1	7809XZN-10-100
12	1	7809XZN-12
12	1	7809XZN-12-100
14	1	7809XZN-14
14	1	7809XZN-14-100
16	1	7809XZN-16
18	1	7809XZN-18



Vasos largos con punta hexagonal, cuadrado 1/2"
En métrica



7809M

Hexagonal tip	Length	Quantity	Part Number
5 mm	61	1	7809M-5-100
5	143	1	7809M-5-180
6 mm	59	1	7809M-6-100
6	103	1	7809M-6-140
7	63	1	7809M-7-100
8	83	1	7809M-8-120
10	103	1	7809M-10-140
5 mm	63	1	SB7809M-5-100
5	140	1	SB7809M-5-180
6 mm	62	1	SB7809M-6-100
6	103	1	SB7809M-6-140
7	63	1	SB7809M-7-100
8	81	1	SB7809M-8-120
10	101	1	SB7809M-10-140

Carraca 1/2" reversible ERGO®



8155-1/2

Length	Teeth	Quantity	Part Number
262	60	1	8155-1/2
262	60	1	SB8155-1/2

SB- Clip para colgar

Llave de carraca 1/2" cabeza delgada 72 dientes
Ángulo de acción de 5°



8150SL

Length	Teeth	Quantity	Part Number
264	72	1	8150SL

Llave de carraca reversible 1/2"
80 dientes/ Ángulo de acción de 4.5°. Sellado



8150-1/2

Length	Teeth	Quantity	Part Number
269	80	1	8150-1/2
269	80	1	SB8150-1/2

SB: Clip para colgar

Llave de carraca reversible, 1/2"
Flecha indicadora del sentido del giro. Patentada



8150RN-1/2

Length	Teeth	Quantity	Part Number
267	72	1	8150RN-1/2
267	72	1	SB8150RN-1/2

SB: Clip para colgar

Llave de carraca reversible de 1/2"
60 dientes/ Ángulo de acción de 6°



SBS81

Length	Teeth	Quantity	Part Number
250	60	5	SBS81

Llave de carraca reversible de 1/2"
60 dientes/ Ángulo de acción 6°



SBS82

Length	Teeth	Quantity	Part Number
252	60	1	SBS82

Carraca 1/2" con cabeza giratoria



8120-1/2

Length	Teeth	Quantity	Part Number
266 mm	72	12	8120-1/2

Llave de carraca reversible de 1/2", cuadrado pasante



8193-1/2

Length	Teeth	Quantity	Part Number
253	48	1	8193-1/2

Carraca reversible 1/2", cuadrado pasante



8195-R

Length	Teeth	Quantity	Part Number
260 mm	60	1	8195-R



Set carraca de válvula de radiador



8195-SET







1 8195-SET

8195-R	
8195-SQ	
8195-KEY	

Llave de carraca articulada de 1/2" reversible



8110-1/2

			
424	60	1	8110-1/2
424	60	1	SB8110-1/2

SB: Clip para colgar

Llave de carraca articulada de 1/2" reversible



8110H-1/2

			
440	32	1	8110H-1/2

Conductor para la llave de carraca 8193-1/2



8194-1/2

		
32	1	8194-1/2

Conductor para carraca 8195-R



8195-SQ

			
37.5 mm	40	25	8195-SQ

Adaptador para llave de carraca de 1/2"



8151-1/2

		
71	1	8151-1/2

Kit de reparación para llave de carraca de 1/2" 8155-1/2
6 piezas



8155-SO/1

			
6	8155-1/2	1	8155-SO/1

Kit de reparación para carraca 1/2 8150-1/2



8150-1/2-SPARE

			
11	8150-1/2	1	8150-1/2-SPARE

Kit de reparación para carraca 1/2 8150RN-1/2



8150RN-1/2-SPARE

			
6	8150RN-1/2	1	8150RN-1/2-SPARE

Kit de reparación para carraca cabeza delgada 1/2" 8150SL



8150SL-SPARE

			
12	8150SL	1	8150SL-SPARE

Kit de reparación para llave de carraca de 1/2" 8110-1/2





8110-SO/1

			
8	8110-1/2	1	8110-SO/1

Kit de reparación para mango articulado 1/2" 8158-1/2
3 piezas



8158-SO/1

		
70	1	8158-SO/1



Juego de 10 vasos con punta 1/2", mm
Caja de plástico



7809M/10

45 x 110 x 255 mm 1 7809M/10

7809M-10, 7809M-12, 7809M-14,
7809M-17, 7809M-19, 7809M-5, 7809M-6,
7809M-7, 7809M-8, 7809M-9

Juego de 10 vasos con puntas TORX® y
HEXAGONALES 1/2"
Caja de plástico



7809TORX/10

45 x 110 x 255 mm 1 7809TORX/10

7809TORX-T20, 7809TORX-T27,
7809TORX-T25, 7809TORX-T40,
7809TORX-T30, 7809TORX-T45,
7809TORX-T50, 7809TORX-T55
7809M-6, 7809M-8

Juego de llaves de vaso 1/2", 10 piezas
Caja de plástico



7819SRE

60 x 115 x 280 mm 1 7819SRE

7800SM-17, 7800SM-22, 7800SM-19,
7800SM-24, 7800SM-10, 7800SM-11,
7800SM-12, 7800SM-13

8160-1/2

8155-1/2

Juego de vasos 1/2", 14 piezas
Caja de plástico



7814DS

60 x 185 x 445 mm 1 7814DS

7800DM-10, 7800DM-11, 7800DM-12,
7800DM-13, 7800DM-14, 7800DM-15,
7800DM-16, 7800DM-17, 7800DM-18,
7800DM-19

8150SL

8160-1/2, 8162-1/2

8166-1/2

Juego de vasos 1/2", 18 piezas
Caja de plástico



7818DS

60 x 185 x 445 mm 1 7818DS

7800DM-8, 7800DM-10, 7800DM-11,
7800DM-12, 7800DM-13, 7800DM-14,
7800DM-15, 7800DM-16, 7800DM-17,
7800DM-18, 7800DM-19, 7800DM-21,
7800DM-22

8150SL

8160-1/2, 8162-1/2

8166-1/2

8154-1/2

Juego de llaves de vaso 1/2", 17 piezas
Caja de plástico



7818MHR

50 x 185 x 445 mm	1	7818MHR

7800SM-10, 7800SM-11, 7800SM-12, 7800SM-13, 7800SM-14, 7800SM-15, 7800SM-17, 7800SM-19, 7800SM-22, 7800SM-24, 7800SM-27, 7800SM-30, 7800SM-32		
8150RN-1/2		
8160-1/2, 8162-1/2		
8154-1/2		
8166-1/2		

Juego de llaves de vaso 1/2", 25 piezas
Caja de plástico



7825MHP

60 x 185 x 445 mm	1	7825MHP

7800SM-10, 7800SM-11, 7800SM-12, 7800SM-13, 7800SM-14, 7800SM-15, 7800SM-16, 7800SM-17, 7800SM-18, 7800SM-19, 7800SM-20, 7800SM-21, 7800SM-22, 7800SM-23, 7800SM-24, 7800SM-26, 7800SM-27, 7800SM-28, 7800SM-30, 7800SM-32		
8160-1/2, 8162-1/2		
8154-1/2		
8166-1/2		
8150-1/2		

Juego de llaves de vaso 1/2", 26 piezas
Caja de plástico



7825MBP

60 x 185 x 445 mm	1	7825MBP

7800DM-10, 7800DM-11, 7800DM-12, 7800DM-13, 7800DM-14, 7800DM-15, 7800DM-16, 7800DM-17, 7800DM-18, 7800DM-19, 7800DM-20, 7800DM-21, 7800DM-22, 7800DM-23, 7800DM-24, 7800DM-26, 7800DM-27, 7800DM-28, 7800DM-30, 7800DM-32		
8150-1/2		
8160-1/2, 8162-1/2		
8154-1/2		
8166-1/2		

Juego de llaves de vaso 1/2", 25 piezas
Caja de plástico



7819DRN

51 x 225 x 445 mm	1	7819DRN

7800DM-19, 7800DM-18, 7800DM-17, 7800DM-16, 7800DM-23, 7800DM-22, 7800DM-21, 7800DM-11, 7800DM-10, 7800DM-15, 7800DM-13, 7800DM-14, 7800DM-12, 7800DM-24, 7800DM-26, 7800DM-27, 7800DM-28, 7800DM-30, 7800DM-32		
8150RN-1/2		
8152-1/2		
8162-1/2		
8154-1/2		
8160-1/2		
8166-1/2		

Juego de llaves de vaso 1/2", 25 piezas
Caja de plástico



7888DM

73 x 340 x 445 mm	1	7888DM

7800DM-10, 7800DM-11, 7800DM-12, 7800DM-13, 7800DM-14, 7800DM-15, 7800DM-16, 7800DM-17, 7800DM-18, 7800DM-19, 7800DM-20, 7800DM-21, 7800DM-22, 7800DM-23, 7800DM-24, 7800DM-26, 7800DM-27, 7800DM-28, 7800DM-30, 7800DM-32		
8150-1/2		
8154-1/2		
8159-1/2, 8160-1/2, 8162-1/2		
8166-1/2		
8158-1/2		

Juego de vasos y accesorios 1/2", 23 piezas
Caja de plástico



7823SE

60 x 185 x 445 mm	1	7823SE

7800SM-10, 7800SM-11, 7800SM-12, 7800SM-13, 7800SM-14, 7800SM-15, 7800SM-17, 7800SM-19, 7800SM-22, 7800SM-24, 7800SM-27, 7800SM-30		
7809M-5, 7809M-6, 7809M-7, 7809M-8, 7809M-10, 7809M-12, 7809M-14		
8155-1/2		
8162-1/2		
8154-1/2		
8166-1/2		



Juego de vasos 1/4" y 1/2", 47 piezas
Caja de plástico



7847SS

60 x 225 x 445 mm	1 7847SS

6700SM-5, 6700SM-6, 6700SM-7, 6700SM-8, 6700SM-9, 6700SM-10, 6700SM-11, 6700SM-12, 6700SM-13	
6950SL	
6960, 6962	
6954	
6966	
6956	
59S/PH1, 59S/PH2, 59S/PH3	
59S/PZ1, 59S/PZ2, 59S/PZ3	
59S/0.6-4.5, 59S/0.8-5.5, 59S/1.2-8.0	
59S/H3, 59S/H4, 59S/H5, 59S/H6	
7800SM-10, 7800SM-11, 7800SM-12, 7800SM-13, 7800SM-14, 7800SM-15, 7800SM-17, 7800SM-19, 7800SM-22, 7800SM-24, 7800SM-27, 7800SM-30, 7800SM-32	
8150SL	
8160-1/2, 8162-1/2	
8154-1/2	
8166-1/2	
6973A	

Juego de vasos 1/2", AF, 17 piezas
Caja de plástico



7817DZS

60 x 185 x 445 mm	1 7817DZS

7800DZ-3/8, 7800DZ-7/16, 7800DZ-1/2, 7800DZ-9/16, 7800DZ-5/8, 7800DZ-11/16, 7800DZ-3/4, 7800DZ-13/16, 7800DZ-7/8, 7800DZ-15/16, 7800DZ-1, 7800DZ-1.1/8, 7800DZ-1.1/4	
8150SL	
8160-1/2, 8162-1/2	
8166-1/2	

Juego de vasos 1/2", AF, 23 piezas
Caja de plástico



7823DZS

60 x 185 x 445 mm	1 7823DZS

7800DZ-3/8, 7800DZ-7/16, 7800DZ-1/2, 7800DZ-9/16, 7800DZ-19/32, 7800DZ-5/8, 7800DZ-11/16, 7800DZ-3/4, 7800DZ-25/32, 7800DZ-13/16, 7800DZ-7/8, 7800DZ-15/16, 7800DZ-1, 7800DZ-1.1/16, 7800DZ-1.1/8, 7800DZ-1.3/16, 7800DZ-1.1/4, 7800DZ-1.5/16	
8150SL	
8160-1/2, 8162-1/2	
8166-1/2	
8154-1/2	

Juego de vasos 1/2", 14 piezas
Estuche textil



7814DST

60 x 220 x 480 mm	1 7814DST

7800DM-10, 7800DM-11, 7800DM-12, 7800DM-13, 7800DM-14, 7800DM-15, 7800DM-16, 7800DM-17, 7800DM-18, 7800DM-19	
8150SL	
8160-1/2, 8162-1/2	
8166-1/2	

Juego de vasos 1/2", 18 piezas
Estuche textil



7818DST

60 x 220 x 480 mm	1 7818DST

7800DM-8, 7800DM-10, 7800DM-11, 7800DM-12, 7800DM-13, 7800DM-14, 7800DM-15, 7800DM-16, 7800DM-17, 7800DM-18, 7800DM-19, 7800DM-21, 7800DM-22	
8150SL	
8160-1/2, 8162-1/2	
8166-1/2	
8154-1/2	

Juego de vasos 1/2", 18 piezas
Estuche textil



7818SST

60 x 220 x 480 mm	1 7818SST

7800SM-10, 7800SM-11, 7800SM-12, 7800SM-13, 7800SM-14, 7800SM-15, 7800SM-17, 7800SM-19, 7800SM-22, 7800SM-24, 7800SM-27, 7800SM-30, 7800SM-32	
8150SL	
8160-1/2, 8162-1/2	
8166-1/2	
8154-1/2	

Juego de vasos 1/2", 25 piezas
Estuche textil



7825SST

65 x 250 x 480 mm 1 7825SST

- 7800SM-10, 7800SM-11, 7800SM-12, 7800SM-13, 7800SM-14, 7800SM-15, 7800SM-16, 7800SM-17, 7800SM-18, 7800SM-19, 7800SM-20, 7800SM-21, 7800SM-22, 7800SM-23, 7800SM-24, 7800SM-26, 7800SM-27, 7800SM-28, 7800SM-30, 7800SM-32
- 8150SL
- 8160-1/2, 8162-1/2
- 8166-1/2
- 8154-1/2

Juego de vasos 1/2", 25 piezas
Estuche textil



7825DST

65 x 250 x 480 mm 1 7825DST

- 7800DM-10, 7800DM-11, 7800DM-12, 7800DM-13, 7800DM-14, 7800DM-15, 7800DM-16, 7800DM-17, 7800DM-18, 7800DM-19, 7800DM-20, 7800DM-21, 7800DM-22, 7800DM-23, 7800DM-24, 7800DM-26, 7800DM-27, 7800DM-28
- 8150SL
- 8160-1/2, 8162-1/2
- 8166-1/2
- 8154-1/2

Juego de vasos 1/2", 27 piezas
Estuche textil



7827DST

65 x 250 x 480 mm 1 7827DST

- 7800DM-10, 7800DM-11, 7800DM-12, 7800DM-13, 7800DM-14, 7800DM-15, 7800DM-16, 7800DM-17, 7800DM-18, 7800DM-19, 7800DM-20, 7800DM-21, 7800DM-22, 7800DM-23, 7800DM-24, 7800DM-26, 7800DM-27, 7800DM-28, 7800DM-30, 7800DM-32
- 8150SL
- 8159-1/2, 8160-1/2, 8162-1/2
- 8154-1/2
- 8166-1/2
- 8158-1/2

Juego de vasos de 1/2", 23 piezas
Estuche textil



7823DET

60 x 220 x 480 mm 1 7823DET

- 7800DM-10, 7800DM-11, 7800DM-12, 7800DM-13, 7800DM-14, 7800DM-15, 7800DM-17, 7800DM-19, 7800DM-22, 7800DM-24, 7800DM-27, 7800DM-30
- 7809M-5, 7809M-6, 7809M-7, 7809M-8, 7809M-10, 7809M-12, 7809M-14
- 8155-1/2
- 8162-1/2
- 8154-1/2
- 8166-1/2

Juego de 12 vasos 1/2" serie larga
Vasos largos hexagonales



S1612L

49 x 152 x 280 mm 4 S1612L

Juego de llaves de vaso 1/2", 24 piezas
24 piezas



S240

100 x 215 x 375 mm 4 S240

SBS81

Juego de llaves de vaso 1/2"
23 piezas, pulgadas



S240AF

100 x 215 x 375 mm 4 S240AF



Juego de llaves de vaso 1/2" y llaves mixtas, 40 piezas
40 piezas



S400



110 x 320 x 375 mm

2 S400

Juego vasos de 1/2" y 1/4" 56 piezas
Vasos bihex



S560



100 x 215 x 375 mm

4 S560

Juego de vasos de 95 piezas 1/4" y 1/2"
Juego de llaves combinadas, llaves hexagonales y puntas



S95



375 mm

320 mm

2 S95

Juego llaves combinados y vasos 1/4" y 1/2", 103 piezas



S103



110 x 375 x 430 mm

2 S103

Juego llaves de vaso 1/4" y 1/2", 81 piezas



S81MIX



110 x 430 x 375 mm

2 S81MIX

Juego de 10 llaves de vaso 1/2" en rail, mm



7810MH



10

1 7810MH

7800SM-10, 7800SM-11, 7800SM-13,
7800SM-14, 7800SM-15, 7800SM-16,
7800SM-17, 7800SM-19, 7800SM-21,
7800SM-22



Juego de llaves de vaso 1/2"+1/4", 108 piezas



S108

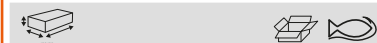

110 x 430 x 375 mm

2 S108

Juego de 18 vasos de 1/2" con puntas TORX
Puntas desde T20 hasta T60, cortas y largas



S18TORX



370 mm

210 mm

4 S18TORX

Juego de 10 llaves de vaso 1/2"
Bi-hex mm, en rail



7810MB



10

1 7810MB

7800DM-10, 7800DM-11, 7800DM-13,
7800DM-14, 7800DM-15, 7800DM-16,
7800DM-17, 7800DM-19, 7800DM-21,
7800DM-22



Juego de 6 llaves de vaso 1/2" en rail, mm



7806MD

6	1	7806MD

7805DM-10, 7805DM-13, 7805DM-14,
7805DM-17, 7805DM-19, 7805DM-22

Juego de 6 llaves de vaso 1/2" en rail



7807TE

7	1	7807TE

7800TORX-E10, 7800TORX-E12,
7800TORX-E14, 7800TORX-E16,
7800TORX-E18, 7800TORX-E20,
7800TORX-E24

3/4"

Vasos de 3/4" hexagonales, mm
Perfil hexagonal, en mm.



8900SM

19	1	8900SM-19
22	1	8900SM-22
23	1	8900SM-23
24	1	8900SM-24
26	1	8900SM-26
27	1	8900SM-27
28	1	8900SM-28
29	1	8900SM-29
30	1	8900SM-30

32	1	8900SM-32
33	1	8900SM-33
34	1	8900SM-34
35	1	8900SM-35
36	1	8900SM-36
38	1	8900SM-38
41	1	8900SM-41
42	1	8900SM-42
46	1	8900SM-46
50	1	8900SM-50
55	1	8900SM-55
60	1	8900SM-60

Vasos estándar, cuadradillo 3/4"
Perfil hexagonal, en pulgadas



8900SZ

3/4" in	1	8900SZ-3/4
13/16" in	1	8900SZ-13/16
7/8" in	1	8900SZ-7/8
15/16" in	1	8900SZ-15/16
1" in	1	8900SZ-1
1.1/16" in	1	8900SZ-1.1/16
1.1/8" in	1	8900SZ-1.1/8
1.1/4" in	1	8900SZ-1.1/4
1.5/16" in	1	8900SZ-1.5/16
1.3/8" in	1	8900SZ-1.3/8
1.7/16" in	1	8900SZ-1.7/16
1.1/2" in	1	8900SZ-1.1/2
1.9/16" in	1	8900SZ-1.9/16
1.5/8" in	1	8900SZ-1.5/8
1.3/4" in	1	8900SZ-1.3/4
1.13/16" in	1	8900SZ-1.13/16
1.7/8" in	1	8900SZ-1.7/8

Vaso longitud estándar, cuadrado 3/4"
Bihexagonal, mm



8900DM

19	1	8900DM-19
21	5	8900DM-21
22	1	8900DM-22
23	1	8900DM-23
24	1	8900DM-24

25	1	8900DM-25
26	1	8900DM-26
27	1	8900DM-27
28	1	8900DM-28
29	1	8900DM-29
30	1	8900DM-30
32	1	8900DM-32
33	1	8900DM-33
34	1	8900DM-34
35	1	8900DM-35
36	1	8900DM-36
37 mm	1	8900DM-37
38	1	8900DM-38
40	1	8900DM-40
41	1	8900DM-41
42	1	8900DM-42
46	1	8900DM-46
47 mm	1	8900DM-47
50	1	8900DM-50
52	1	8900DM-52
40	3	8900DM-54
55	1	8900DM-55
56	1	8900DM-56
60	1	8900DM-60

Vaso longitud estándar, cuadrado 3/4"
Bihexagonal, en pulgadas



8900DZ

3/4	1	8900DZ-3/4
13/16	1	8900DZ-13/16
7/8	1	8900DZ-7/8
15/16	1	8900DZ-15/16
31/32 in	1	8900DZ-31/32
1	1	8900DZ-1
1 1/16	1	8900DZ-1.1/16
1 1/8	1	8900DZ-1.1/8
1 3/16	1	8900DZ-1.3/16
1 1/4	1	8900DZ-1.1/4
1 5/16	1	8900DZ-1.5/16
1 3/8	1	8900DZ-1.3/8
1 7/16	1	8900DZ-1.7/16
1 1/2	1	8900DZ-1.1/2
1.9/16	1	8900DZ-1.9/16
1 5/8	1	8900DZ-1.5/8
1.11/16	1	8900DZ-1.11/16
1 3/4	1	8900DZ-1.3/4
1 13/16	1	8900DZ-1.13/16
1 7/8	1	8900DZ-1.7/8
2	1	8900DZ-2
2.1/16	1	8900DZ-2.1/16
2.1/8	1	8900DZ-2.1/8
2.3/16 in	1	8900DZ-2.3/16
2.1/4	1	8900DZ-2.1/4
2.3/8	1	8900DZ-2.3/8



Mango universal para cabeza de carraca de 3/4" 8950N/A.
Para cabeza de carraca 8950 N/A, cabeza para mango articulado 8958A y cabeza corrediza 8954A.



8953



505

1 8953

Compatible con 8958A y 8954A

Mango universal para 8952N/A



8952N/B



450

1 8952N/B

Mango corredizo en T de 3/4"
Mango universal 8953 y cabeza 8954A



8954



505

1 8954

Cabeza corrediza de 3/4"
Junto mango universal 8953 completa mango corredizo en T 8954.



8954A



62

1 8954A

Mango articulado 3/4"
Cabeza 8958A y mango universal 8953.



8958



570

1 8958

Cabeza para mango articulado de 3/4"
Junto con el mango universal 8953 forma el mango articulado 8958



8958A



125

1 8958A

Mango acodado 3/4"



8963



415

1 8963

Alargadera de 3/4"



8961/8962



200

1 8961

400

1 8962

Articulación universal de 3/4"



8966



120

1 8966

Reductor de entrada 3/4" a salida 1/2"



8965



3/4"

1/2"

1 8965

Aumentador de entrada 3/4" a salida 1"



9564



3/4"

1"

1 9564

Llave de carraca de 3/4" reversible



8950N



612

1 8950N

Compuesto por 8950N/A + 8953

Carraca 3/4", cuadrado pasante



8952N



525 1 8952N

Compuesto por 8952N/B + 8952N/A

Carracas 3/4"



8955N



1 8955N

Cabeza de carraca de 3/4", reversible
Con el mango 8953 forma la carraca 8950N



8950N/A



170 1 8950N/A

Cabeza de carraca 3/4", cuadrado pasante
Con el mango 8952N/B forma la carraca 8952N



8952N/A



145 1 8952N/A

Cabeza para carraca de 3/4"
Liberación rápida



8955N/A

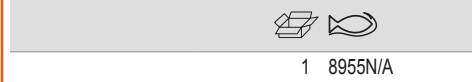

1 8955N/A

Mango universal 3/4"



8955N/B

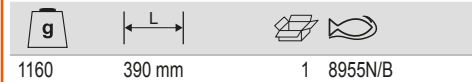

1160 390 mm 1 8955N/B

Cabeza de carraca 3/4" cuadrado macho y hembra
Diámetro máximo 60 mm



8951



95.5 1 8951

Compatible con mango corredizo

Repuesto para carraca 3/4" 8952N y 8952N/A



744T

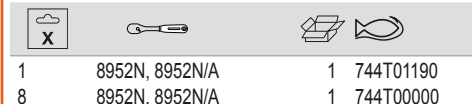

1 8952N, 8952N/A 1 744T01190
8 8952N, 8952N/A 1 744T00000

744T01190: cuadrado - 744T00000 kit reparador

Kit de reparación para carracas de 3/4" 8950N,
8950N/A
8 piezas



8950NA-SO/2



8 8950N, 8950N/A 1 8950NA-SO/2

Repuesto para carracas de 3/4"



8955N-SPARE



1 8955N-SPARE

Juego de llaves de vaso hex 3/4", 15 piezas, mm
Vasos hexagonales, en mm.



8845NM



94 x 206 x 591 mm 1 8845NM

8900SM-24, 8900SM-22, 8900SM-27,
8900SM-30, 8900SM-32, 8900SM-36,
8900SM-38, 8900SM-41, 8900SM-46,
8900SM-50

8953	
8954A	
8962	
8950N/A	
8961	



Juego de llaves de vaso 3/4", 15 piezas
Bihexagonal, mm



8845DM



94 x 206 x 591 mm

1 8845DM

8900DM-19, 8900DM-22, 8900DM-24, 8900DM-27, 8900DM-30, 8900DM-32, 8900DM-36, 8900DM-41, 8900DM-46, 8900DM-50	
8950N/A	
8953	
8954A	
8961, 8962	

Juego de llaves de vaso 3/4", 23 piezas



8821MB



95 x 220 x 600 mm

1 8821MB

8950N/A	
8954	
8965	
8966	
8961, 8962	
8900DM-22, 8900DM-23, 8900DM-24, 8900DM-26, 8900DM-27, 8900DM-28, 8900DM-29, 8900DM-30, 8900DM-32, 8900DM-34, 8900DM-35, 8900DM-36, 8900DM-38, 8900DM-41, 8900DM-42, 8900DM-46, 8900DM-50	

Juego de llaves de vaso 3/4", 24 piezas
Bihexagonal, mm



8840M



100 x 210 x 595 mm

1 8840M

8900DM-27, 8900DM-28, 8900DM-19, 8900DM-22, 8900DM-25, 8900DM-24, 8900DM-32, 8900DM-30, 8900DM-55, 8900DM-60, 8900DM-46, 8900DM-50, 8900DM-41, 8900DM-36	
8953	
8954A	
8962	
8966	
8965	
8950N/A	
8961	
8951	
8964	
8958A	

Juego de vasos de 3/4", 17 piezas
mm



SLX 17



375 x 430 x 110 mm

1 SLX 17

41 x 37 x 510 mm

1 S93

12 vasos hex 22-50, Cabeza carraca 24d-S91, Mango
ext S93, Cuadrado mango corr, Alarg 200, Alarg 400

Juego de vasos hex 3/4" 17 piezas
En pulgadas



SLX17AF



70 x 375 x 430 mm

1 SLX 17AF

12 vasos hex, Cabeza carraca 24d-S91, Mango
ext S93, Cuadrado mango corr, Alarg 8", Alarg 16"

1"

Vaso Hexagonal 1", mm
Perfil hexagonal, en mm



9500SM

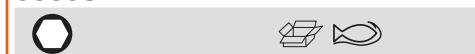

41	1	9500SM-41
46	1	9500SM-46
50	1	9500SM-50
54	1	9500SM-54
55	1	9500SM-55
58	1	9500SM-58
60	1	9500SM-60
63	1	9500SM-63
65	1	9500SM-65
67	1	9500SM-67
70	1	9500SM-70
71	1	9500SM-71
75	1	9500SM-75
77	1	9500SM-77
80	1	9500SM-80
82	1	9500SM-82

Vaso estándar, cuadradillo 1"
Bi-hexagonal, en pulgadas



9500DZ



1.5/8 in	1	9500DZ-1.5/8
1.13/16 in	1	9500DZ-1.13/16
1.7/8 in	1	9500DZ-1.7/8
2 in	1	9500DZ-2
2.1/8 in	1	9500DZ-2.1/8
2.3/16 in	1	9500DZ-2.3/16
2.1/4 in	1	9500DZ-2.1/4
2.3/8 in	1	9500DZ-2.3/8
2.1/2 in	1	9500DZ-2.1/2
2.9/16 in	1	9500DZ-2.9/16
2.5/8 in	1	9500DZ-2.5/8
2.3/4 in	1	9500DZ-2.3/4
2.15/16 in	1	9500DZ-2.15/16
3 in	1	9500DZ-3
3.1/8 in	1	9500DZ-3.1/8

Cabeza corrediza, 1"
Junto con mango universal 9550AB forma el mango
corredizo en T 9555



9555AB



78x78x78



1 9555AB

Mango universal 1"



9550N/B



1960



1 9550N/B

Alargadera 1"



9560AB/9563AB



200

440



1 9560AB

1 9563AB

Articulación universal 1"



9566A



167



1 9566A

Reductor de 1" a 3/4"



9565AB



1"



1"



1 9565AB

Cabeza para carraca 1"
Liberación rápida



9550N/A



1 in



72



1 9550N/A

Mango corredizo en T 1"
Cabeza de mango corredizo 9555AB y mango
universal 9552AB



9555



508



1 9555

Carraca de 1"
Liberación rápida



9550N



1 in



5



1 9550N

Repuesto para carracas de 1"



9550N-SPARE



1 9550N-SPARE



Juego de llaves de vaso 1", mm
Caja de metal



9540MB

210 x 560 x 120 mm	1 9540MB

9500SM-80, 9500SM-75, 9500SM-70, 9500SM-65, 9500SM-60, 9500SM-55, 9500SM-50, 9500SM-46	
9550AB	
9555	
9560AB, 9563AB	

Juego de llaves de vaso 1", mm, 18 piezas
Caja de metal



9540MBL

225 x 605 x 120 mm	1 9540MBL

9500SM-80, 9500SM-77, 9500SM-71, 9500SM-70, 9500SM-67, 9500SM-65, 9500SM-63, 9500SM-60, 9500SM-75, 9500SM-46, 9500SM-50, 9500SM-54, 9500SM-55, 9500SM-58	
9550AB	
9560AB, 9563AB	
9555	

Juego de 12 llaves de vaso bi-hexagonal 1", en
pulgadas
Caja de metal



9540DZ

1 9540DZ

9550AB	
9555	
9563AB, 9560AB	
9500DZ-1.13/16, 9500DZ-2, 9500DZ- 2.3/16, 9500DZ-2.3/4, 9500DZ-2.3/8, 9500DZ-2.5/8, 9500DZ-3, 9500DZ-3.1/8	

Juego de 19 llaves de vaso bi-hexagonal 1", en
pulgadas
Caja de metal



9540DZL

1 9540DZL

9500DZ-2.1/4, 9500DZ-2.3/4, 9500DZ- 2.3/8, 9500DZ-2.1/2, 9500DZ-2.15/16, 9500DZ-2.1/8, 9500DZ-1.7/8, 9500DZ- 2.3/16, 9500DZ-3, 9500DZ-1.13/16, 9500DZ-3.1/8, 9500DZ-2.5/8, 9500DZ- 2, 9500DZ-2.9/16	
9550AB	
9555	
9563AB, 9560AB	
9565AB	

HERRAMIENTAS DE IMPACTO 1/4"

Vaso de impacto hexagonal 1/4"



K6701M

6	1 K6701M-6
7	1 K6701M-7
8	1 K6701M-8
9	1 K6701M-9
10	1 K6701M-10
11	1 K6701M-11
12	1 K6701M-12
13	1 K6701M-13
14	1 K6701M-14

Vaso impacto 1/4" magnético



KM6701M

7	1 KM6701M-7
8	1 KM6701M-8
10	1 KM6701M-10

Muelle de fijación



K560F-1

1/4"	6-14	5 K560F-1

HERRAMIENTAS DE IMPACTO 3/8"

Vaso de impacto hexagonal 3/8", mm



K7401M

7	1	K7401M-7		
8	1	K7401M-8		
9	1	K7401M-9		
10	1	K7401M-10		
11	1	K7401M-11		
12	1	K7401M-12		
13	1	K7401M-13		
14	1	K7401M-14		
15	1	K7401M-15		
16	1	K7401M-16		
17	1	K7401M-17		
18	1	K7401M-18		
19	1	K7401M-19		
20	1	K7401M-20		
21	1	K7401M-21		
22	1	K7401M-22		
24	1	K7401M-24		

Vaso de impacto hexagonal 3/8", en pulgadas



K7401Z

3/8" in	1	K7401Z-3/8		
3/8" in	1	K7401Z-7/16		
3/8" in	1	K7401Z-1/2		
3/8" in	1	K7401Z-9/16		
3/8" in	1	K7401Z-5/8		
3/8" in	1	K7401Z-11/16		
3/8" in	1	K7401Z-3/4		
3/8" in	1	K7401Z-13/16		
3/8" in	1	K7401Z-7/8		

Vaso de impacto serie larga 3/8", mm



K7406M

10	1	K7406M-10		
13	1	K7406M-13		
17	1	K7406M-17		

Vaso de impacto giratorio hexagonal 3/8", mm



KS7401M

3/8 in	1	KS7401M-9		
3/8 in	1	KS7401M-10		
3/8 in	1	KS7401M-11		
3/8 in	1	KS7401M-12		
3/8 in	1	KS7401M-13		
3/8 in	1	KS7401M-14		
3/8 in	1	KS7401M-15		
3/8 in	1	KS7401M-16		
3/8 in	1	KS7401M-17		
3/8 in	1	KS7401M-18		
3/8 in	1	KS7401M-19		
3/8 in	1	KS7401M-22		

Vaso de impacto 3/8" TORX®



K7401TORX-E

E5	M4	1	K7401TORX-E5	
E6	M5	1	K7401TORX-E6	
E7	M6	1	K7401TORX-E7	

E8	M6, M7	1	K7401TORX-E8
E10	M6, M8	1	K7401TORX-E10
E12	M8, M10	1	K7401TORX-E12
E14	M10, M12	1	K7401TORX-E14

Alargadera de impacto 3/8"



K7760C

75	1	K7760C-1	
150	1	K7760C-2	

Articulación universal de impacto 3/8"



K7767S

3/8"	3/8"	1	K7767S

Reductor/Amplificador de impacto 3/8"



K6964C/K8164C

1/4"	3/8"	1	K6964C
1/2"	3/8"	1	K8164C



Adaptador de impacto portapuntas 3/8"



7407H-7409H

1/4"	3/8"	1	7407H
5/16"	3/8"	1	7408H
11	3/8"	1	7409H

Adaptador de impacto de 3/8" para puntas de 1/4"



K172

1/4"	1	K172

Muelle de fijación



K560F-2/3

3/8"	7-12	5	K560F-2
3/8"	13-24	5	K560F-3

Juego de 7 vasos de impacto 3/8" E TORX®



K7401TORX-E-S7

263x40x20	1	K7401TORX-E-S7

K7401TORX-E10, K7401TORX-E12,
K7401TORX-E14, K7401TORX-E5,
K7401TORX-E6, K7401TORX-E7,
K7401TORX-E8

HERRAMIENTAS DE IMPACTO 1/2"

Vaso de impacto hexagonal 1/2" mm, ultracorto



K7800M

10 mm	1	K7800M-10
11 mm	1	K7800M-11
12 mm	1	K7800M-12
13 mm	1	K7800M-13
14 mm	1	K7800M-14
15 mm	1	K7800M-15
16 mm	1	K7800M-16
17 mm	1	K7800M-17
18 mm	1	K7800M-18
19 mm	1	K7800M-19
21 mm	1	K7800M-21
22 mm	1	K7800M-22
24 mm	1	K7800M-24

Vaso de impacto 1/2", hexagonal



K7801M

8	1	K7801M-8
9	1	K7801M-9
10	1	K7801M-10
11	1	K7801M-11
12	1	K7801M-12
13	1	K7801M-13
14	1	K7801M-14
15	1	K7801M-15
16	1	K7801M-16
17	1	K7801M-17
18	1	K7801M-18
19	1	K7801M-19
20	1	K7801M-20
21	1	K7801M-21
22	1	K7801M-22
23	1	K7801M-23
24	1	K7801M-24
25	1	K7801M-25
26	1	K7801M-26
27	1	K7801M-27
30	1	K7801M-30
32	1	K7801M-32
34	1	K7801M-34
36	1	K7801M-36

Vaso impacto 1/2", reforzado
Tuercas de llantas



K7801VM

17	1	K7801VM-17
19	1	K7801VM-19
22	1	K7801VM-22
24	1	K7801VM-24

Vaso de impacto serie larga 1/2", hexagonal



K7806M

10	1 K7806M-10
11	1 K7806M-11
12	1 K7806M-12
13	1 K7806M-13
14	1 K7806M-14
15 mm	1 K7806M-15
16	1 K7806M-16
17	1 K7806M-17
18	1 K7806M-18
19	1 K7806M-19
21	1 K7806M-21
22	1 K7806M-22
23	1 K7806M-23
24	1 K7806M-24
27	1 K7806M-27
30	1 K7806M-30
32	1 K7806M-32
36	1 K7806M-36

Vasos de impacto 1/2", serie larga, pulgadas



K7806Z

3/8	10 K7806Z-3/8
7/16	10 K7806Z-7/16
1/2	10 K7806Z-1/2
9/16	10 K7806Z-9/16
5/8	5 K7806Z-5/8
11/16	5 K7806Z-11/16
3/4	5 K7806Z-3/4
7/8	5 K7806Z-7/8
15/16	5 K7806Z-15/16
1	5 K7806Z-1
1 1/16	5 K7806Z-1.1/16
1 1/8	5 K7806Z-1.1/8
1 1/4	5 K7806Z-1.1/4
1 5/16	5 K7806Z-1.5/16
1 3/8	5 K7806Z-1.3/8
1 7/16	5 K7806Z-1.7/16
1 1/2	5 K7806Z-1.1/2

Alargadera de impacto 1/2"



K8160D

75	1 K8160D-1
125	1 K8160D-2
250	1 K8160D-3

Vasos de impacto 1/2", hexagonal, pulgadas



K7801Z

3/8	1 K7801Z-3/8
7/16	1 K7801Z-7/16
1/2	1 K7801Z-1/2
9/16	1 K7801Z-9/16
5/8	1 K7801Z-5/8
11/16	1 K7801Z-11/16
3/4	1 K7801Z-3/4
13/16	1 K7801Z-13/16
7/8	1 K7801Z-7/8
15/16	1 K7801Z-15/16
1	1 K7801Z-1
1 1/16	1 K7801Z-1.1/16
1 1/8	1 K7801Z-1.1/8
1 1/4	1 K7801Z-1.1/4
1 5/16	5 K7801Z-1.5/16
1 3/8	5 K7801Z-1.3/8
1 7/16	5 K7801Z-1.7/16
1 1/2	5 K7801Z-1.1/2

Vaso de impacto TORX® hembra 1/2"



K7801TORX-E

E10	1 K7801TORX-E10
E12	1 K7801TORX-E12
E14	1 K7801TORX-E14
E16	1 K7801TORX-E16
E18	1 K7801TORX-E18
E20	1 K7801TORX-E20
E24	1 K7801TORX-E24

Articulación universal de impacto cardan 1/2"



K8167S

1/2"	1/2"	1 K8167S

Amplificador de entrada 1/2" a salida 3/4"
Reductor de entrada 1/2" a salida 3/8"



K7764D/K8964D

M 3/8"	F 1/2"	1 K7764D
3/4"	1/2"	1 K8964D



Adaptador portapuntas, macho, 1/2"



7807H-7809H

1/2"	1/4"	1	7807H
1/2"	5/16"	1	7808H
1/2"	11.2	1	7809H

Muelle de fijación



K560F-4/5

1/2"	10-14	5	K560F-4
1/2"	15-32	5	K560F-5

Vaso de impacto 1/2" con punta hexagonal



7993S

5	1	7993S0050
6	1	7993S0060
8	1	7993S0080
10	1	7993S0100
12	1	7993S0120
14	1	7993S0140
17	1	7993S0170
19	1	7993S0190

Vaso de impacto 1/2" con punta TORX®



7994S

T-30	1	7994S0300
T-40	1	7994S0400
T-45	1	7994S0450
T-50	1	7994S0500
T-55	1	7994S0550
T-60	1	7994S0600

Juego de 4 vasos de impacto, 1/2"



K7801VM/S4

4	1	K7801VM/S4

K7801VM-17, K7801VM-19,
K7801VM-22, K7801VM-24

Juego de 14 vasos de impacto 1/2" (10-19,21,22,24,27 mm)



D/S14

14	6	D/S14

K7801M-10, K7801M-11, K7801M-12,
K7801M-13, K7801M-14, K7801M-15,
K7801M-16, K7801M-17, K7801M-18,
K7801M-19, K7801M-21, K7801M-22,
K7801M-24, K7801M-27

Juego de vasos de impacto 1/2", serie larga



K7806M/S4

4	1	K7806M/S4

K7806M-17, K7806M-19, K7806M-22,
K7806M-24

Juego de 14 vasos de impacto 1/2", serie larga, mm DD/S14: 10-27mm



DD/S14

14	4	DD/S14

K7806M-10, K7806M-11, K7806M-12,
K7806M-13, K7806M-14, K7806M-15,
K7806M-16, K7806M-17, K7806M-18,
K7806M-19, K7806M-21, K7806M-22,
K7806M-24, K7806M-27

Juego de 20 vasos de impacto (10 standar y 10 largos), serie larga
10,11,12,13,14,15,16,17,18,19mm



D-DD/

20	4	D-DD/S20

K7801M-14, K7801M-15, K7801M-16,
K7801M-11, K7801M-10, K7801M-13,
K7801M-12, K7801M-18, K7801M-19,
K7801M-17

K7806M-10, K7806M-11, K7806M-12,
K7806M-13, K7806M-14, K7806M-16,
K7806M-17, K7806M-18, K7806M-19

Juego de vasos de impacto cuadrado de 1/2",
pulgadas



K7801Z/10

10	60 x 220 x 280 mm	1 K7801Z/10

K7801Z-1, K7801Z-1/2, K7801Z-11/16,
K7801Z-13/16, K7801Z-15/16,
K7801Z-3/4, K7801Z-5/8, K7801Z-7/16,
K7801Z-7/8, K7801Z-9/16

Juego de vasos de impacto serie larga cuadrado de
1/2", pulgadas



K7806Z/10

10	60 x 220 x 280 mm	1 K7806Z/10

K7806Z-1, K7806Z-1/2, K7806Z-11/16,
K7806Z-13/16, K7806Z-15/16,
K7806Z-3/4, K7806Z-5/8, K7806Z-7/16,
K7806Z-7/8, K7806Z-9/16

Juego de 10 vasos de impacto cuadrado 1/2"
D/S10: 10-19mm



D/

10	6	D/S10

K7801M-10, K7801M-11, K7801M-12,
K7801M-13, K7801M-14, K7801M-15,
K7801M-16, K7801M-17, K7801M-18,
K7801M-19

Juego de 10 vasos de impacto, serie larga, mm
DD/S10: 10-19 mm



DD/

10	6	DD/S10

K7806M-10, K7806M-11, K7806M-12,
K7806M-13, K7806M-14, K7806M-15,
K7806M-16, K7806M-17, K7806M-18,
K7806M-19

HERRAMIENTAS DE IMPACTO 3/4"

Vaso de impacto 3/4", hexagonal, mm



K8901M

17	1	K8901M-17
18	1	K8901M-18
19	1	K8901M-19
21	1	K8901M-21
22	1	K8901M-22
23	1	K8901M-23
24	1	K8901M-24
27	1	K8901M-27
28	1	K8901M-28
29	1	K8901M-29
30	1	K8901M-30
32	1	K8901M-32
33	1	K8901M-33
34	1	K8901M-34
36	1	K8901M-36
38	1	K8901M-38
41	1	K8901M-41
46	1	K8901M-46
50	1	K8901M-50
55	1	K8901M-55
60	1	K8901M-60



Vasos de impacto 3/4", hexagonal, pulgadas



K8901Z

Diagram	Diagram	
11/16	1	K8901Z-11/16
3/4	1	K8901Z-3/4
13/16	1	K8901Z-13/16
7/8	1	K8901Z-7/8
15/16	1	K8901Z-15/16
1	1	K8901Z-1
1 1/16	1	K8901Z-1.1/16
1 1/8	1	K8901Z-1.1/8
1 3/16	1	K8901Z-1.3/16
1 1/4	1	K8901Z-1.1/4
1 5/16	1	K8901Z-1.5/16
1 3/8	1	K8901Z-1.3/8
1 7/16	1	K8901Z-1.7/16
1 1/2	1	K8901Z-1.1/2
1 9/16	1	K8901Z-1.9/16
1 5/8	1	K8901Z-1.5/8
1 11/16	1	K8901Z-1.11/16
1 3/4	1	K8901Z-1.3/4
1 13/16	1	K8901Z-1.13/16
1 7/8	1	K8901Z-1.7/8
1 15/16	1	K8901Z-1.15/16
2	1	K8901Z-2
2 1/16	1	K8901Z-2.1/16
2 3/16	1	K8901Z-2.3/16
2 1/4	1	K8901Z-2.1/4
2 3/8	1	K8901Z-2.3/8

Vasos de impacto 3/4" serie larga, pulgadas



K8906Z

Diagram	Diagram	
3/4	1	K8906Z-3/4
13/16	1	K8906Z-13/16
7/8	1	K8906Z-7/8
15/16	1	K8906Z-15/16
1	1	K8906Z-1
1 1/16	1	K8906Z-1.1/16
1.1/8	1	K8906Z-1.1/8
1.1/4	1	K8906Z-1.1/4
1.5/16	1	K8906Z-1.5/16
1.3/8	1	K8906Z-1.3/8
1.7/16	1	K8906Z-1.7/16
1.1/2	1	K8906Z-1.1/2
1.5/8	1	K8906Z-1.5/8
1.3/4	1	K8906Z-1.3/4
2	1	K8906Z-2

Extensión de impacto 3/4"



K8960F

Diagram	Diagram	
175	1	K8960F-2
250	1	K8960F-3
325	10	K8960F-4

Articulación universal de impacto cardan 3/4"



K8967S

Diagram	Diagram	
3/4"	3/4"	1 K8967S

Reductor/Amplificador de impacto de entrada 3/4"



K8164F/K9564F

Diagram	Diagram	
1/2"	3/4"	1 K8164F
1"	3/4"	1 K9564F

Adaptador portapuntas de impacto 3/4", hexágono de 22 mm



K8909H

Diagram	Diagram	
22	3/4"	1 K8909H-5

Muelle de fijación



K560F-6



Diagram	Diagram	
3/4"	17-46	5 K560F-6

Vaso de impacto 3/4" con punta hexagonal



7993T

Diagram	Diagram	
12		1 7993T0120
14		1 7993T0140

 	
17	1 7993T0170
19	1 7993T0190
22	1 7993T0220
24	1 7993T0240

Juego de 8 llaves de vaso de impacto 3/4" mm



K8901M/8

  		
8	65 x 240 x 350 mm	1 K8901M/8

K8901M-21, K8901M-22, K8901M-24, K8901M-27, K8901M-30, K8901M-32, K8901M-36, K8901M-41

Juego de 8 llaves de vaso de impacto de 3/4", pulgadas



K8901Z/8

  		
8	80 x 250 x 310 mm	1 K8901Z/8

K8901Z-1, K8901Z-1.1/16, K8901Z-1.1/2, K8901Z-1.1/4, K8901Z-1.1/8, K8901Z-1.3/8, K8901Z-1.5/16, K8901Z-1.7/16

Juego de 8 vasos de impacto 3/4" serie larga, mm



K8906M/8

  		
8	80 x 250 x 315 mm	1 K8906M/8

K8906M-21, K8906M-22, K8906M-24, K8906M-27, K8906M-30, K8906M-32, K8906M-36, K8906M-41

Juego de 8 llaves de vaso de impacto 3/4" serie larga, pulgadas



K8906Z/8

  		
8	125 x 250 x 110 mm	1 K8906Z/8

K8906Z-1, K8906Z-1.1/16, K8906Z-1.1/2, K8906Z-1.1/4, K8906Z-1.1/8, K8906Z-1.3/8, K8906Z-1.5/16, K8906Z-1.7/16



HERRAMIENTAS DE IMPACTO 1"

Vaso de impacto 1", hexagonal, mm



K9501M



 	
22	1 K9501M-22

 	
24	1 K9501M-24
27	1 K9501M-27
30	1 K9501M-30
32	1 K9501M-32
33	1 K9501M-33
34	1 K9501M-34
36	1 K9501M-36
38	1 K9501M-38
41	1 K9501M-41
42	1 K9501M-42
46	1 K9501M-46
50	1 K9501M-50
55	1 K9501M-55
60	1 K9501M-60
65	1 K9501M-65
70	1 K9501M-70
65	1 K9501M-75
65	1 K9501M-80
85	1 K9501M-85

Vasos de impacto 1", hexagonal, pulgadas



K9501Z

 	
1	1 K9501Z-1
1 1/16	1 K9501Z-1.1/16
1 1/8	1 K9501Z-1.1/8
1 3/16	1 K9501Z-1.3/16
1 1/4	1 K9501Z-1.1/4
1 5/16	1 K9501Z-1.5/16
1 3/8	1 K9501Z-1.3/8
1 7/16	1 K9501Z-1.7/16
1 1/2	1 K9501Z-1.1/2
1 9/16	1 K9501Z-1.9/16
1 5/8	1 K9501Z-1.5/8
1 11/16	1 K9501Z-1.11/16
1 3/4	1 K9501Z-1.3/4
1 13/16	1 K9501Z-1.13/16
1 7/8	1 K9501Z-1.7/8
15/16	1 K9501Z-1.15/16
2	1 K9501Z-2
2 1/8	1 K9501Z-2.1/8
2 3/16	1 K9501Z-2.3/16
2 1/4	1 K9501Z-2.1/4
2 5/16	1 K9501Z-2.5/16
2 9/16	1 K9501Z-2.9/16
2 3/4	1 K9501Z-2.3/4



Vaso de impacto 1", serie larga, hexagonal, mm



K9506M

mm	QTY	Part No.
22	1	K9506M-22
24	1	K9506M-24
27	1	K9506M-27
30	1	K9506M-30
32	1	K9506M-32
33	1	K9506M-33
34	1	K9506M-34
36	1	K9506M-36
38	1	K9506M-38
41	1	K9506M-41
46	1	K9506M-46
50	1	K9506M-50
55	1	K9506M-55
60	1	K9506M-60

mm	QTY	Part No.
175	1	K9560G-2
325	1	K9560G-3
300	1	K9560G-4
400	1	K9560G-5

Articulación universal de impacto cardan 1"



K9567S

mm	QTY	Part No.
1"	1	K9567S

Llave de vaso de impacto 1" punta hexagonal



7993M

mm	QTY	Part No.
17	1	7993M0170
19	1	7993M0190
22	1	7993M0220
27	1	7993M0270

Vasos de impacto 1", serie larga, pulgadas



K9506Z

inches	QTY	Part No.
1	1	K9506Z-1
1 1/16	1	K9506Z-1.1/16
1 3/16	1	K9506Z-1.3/16
1 1/4	1	K9506Z-1.1/4
1 7/16	1	K9506Z-1.7/16
1 1/2	1	K9506Z-1.1/2
1 5/8	1	K9506Z-1.5/8
1 13/16	1	K9506Z-1.13/16
1 7/8	1	K9506Z-1.7/8

Reductor/Amplificador de impacto de entrada 1"



K8964G/K9895G

inches	QTY	Part No.
3/4"	1	K8964G
1 1/2"	1	K9895G

Punta de atornillador mm



K8909ML/K9509ML

mm	QTY	Part No.
12	1	K8909ML-12
14	1	K8909ML-14
17	1	K8909ML-17
19	1	K9509ML-19
22	1	K9509ML-22
24	1	K9509ML-24

Extensión de impacto 1"



K9560G

mm	QTY	Part No.
100	1	K9560G-0
125	1	K9560G-1

Adaptador portapuntas de impacto, hexágono de 22 mm



K9509H5

mm	QTY	Part No.
22	1	K9509H5

Muelle de fijación



K560F-7/8

mm	QTY	Part No.
1"	5	K560F-7
1 & 1 1/2"	5	K560F-8

HERRAMIENTAS DE IMPACTO 1.1/2"

Vasos de impacto 1.1/2"



K9801M

Size	Quantity	Part Number
46	1	K9801M-46
50	1	K9801M-50
55	1	K9801M-55
60	1	K9801M-60
65	1	K9801M-65
70	1	K9801M-70
75	1	K9801M-75
80	1	K9801M-80
85	1	K9801M-85
90	1	K9801M-90
95	1	K9801M-95
100	1	K9801M-100
105	1	K9801M-105
110	1	K9801M-110
115	1	K9801M-115
120	1	K9801M-120
125	1	K9801M-125
130	1	K9801M-130
135	1	K9801M-135
140	1	K9801M-140
145	1	K9801M-145
150	1	K9801M-150
155	1	K9801M-155

Vasos de impacto 1.1/2", pulgadas
Se fabrica bajo demanda



K9801Z

Size	Quantity	Part Number
1 3/8	1	K9801Z-1.3/8
1 7/16	1	K9801Z-1.7/16
1 1/2	1	K9801Z-1.1/2
1 9/16	1	K9801Z-1.9/16
1 5/8	1	K9801Z-1.5/8
1 11/16	1	K9801Z-1.11/16
1 3/4	1	K9801Z-1.3/4
1 13/16	1	K9801Z-1.13/16
1 7/8	1	K9801Z-1.7/8
1 15/16	1	K9801Z-1.15/16
2	1	K9801Z-2

Size	Quantity	Part Number
2 1/16	1	K9801Z-2.1/16
2 1/8	1	K9801Z-2.1/8
2 3/16	1	K9801Z-2.3/16
2 1/4	1	K9801Z-2.1/4
2 5/16	1	K9801Z-2.5/16
2 3/8	1	K9801Z-2.3/8
2 7/16	1	K9801Z-2.7/16
2 1/2	1	K9801Z-2.1/2
2 9/16	1	K9801Z-2.9/16
2 5/8	1	K9801Z-2.5/8
2 11/16	1	K9801Z-2.11/16
2 3/4	1	K9801Z-2.3/4
2 13/16	1	K9801Z-2.13/16
2 7/8	1	K9801Z-2.7/8
2 15/16	1	K9801Z-2.15/16
3	1	K9801Z-3
3 1/16	1	K9801Z-3.1/16
3 1/8	1	K9801Z-3.1/8
3 1/4	1	K9801Z-3.1/4
3 5/16	1	K9801Z-3.5/16
3 3/8	1	K9801Z-3.3/8
3 7/16	1	K9801Z-3.7/16
3 1/2	1	K9801Z-3.1/2
3 9/16	1	K9801Z-3.9/16
3 5/8	1	K9801Z-3.5/8
3 11/16	1	K9801Z-3.11/16
3 3/4	1	K9801Z-3.3/4
3 13/16	1	K9801Z-3.13/16
3 7/8	1	K9801Z-3.7/8
3 15/16	1	K9801Z-3.15/16
4	1	K9801Z-4
4 1/16	1	K9801Z-4.1/16
4 1/8	1	K9801Z-4.1/8
4 1/4	1	K9801Z-4.1/4
4 5/16	1	K9801Z-4.5/16
4 3/8	1	K9801Z-4.3/8
4 7/16	1	K9801Z-4.7/16
4 1/2	1	K9801Z-4.1/2
4 5/8	1	K9801Z-4.5/8
4 3/4	1	K9801Z-4.3/4

Vasos de impacto profundos 1.1/2", mm
Se fabrica bajo demanda



K9806M

Size	Quantity	Part Number
41	1	K9806M-41
46	1	K9806M-46
50	1	K9806M-50
55	1	K9806M-55
60	1	K9806M-60
65	1	K9806M-65
70	1	K9806M-70
75	1	K9806M-75
80	1	K9806M-80
85	1	K9806M-85
90	1	K9806M-90
95	1	K9806M-95
100	1	K9806M-100

Size	Quantity	Part Number
105	1	K9806M-105
110	1	K9806M-110
115	1	K9806M-115
120	1	K9806M-120

Vasos de impacto profundos 1.1/2", pulgadas
Se fabrica bajo demanda



K9806Z

Size	Quantity	Part Number
1 3/8	1	K9806Z-1.3/8
1 7/16	1	K9806Z-1.7/16
1 1/2	1	K9806Z-1.1/2
1 5/8	1	K9806Z-1.5/8
1 11/16	1	K9806Z-1.11/16
2	1	K9806Z-2
2 1/16	1	K9806Z-2.1/16
2 3/16	1	K9806Z-2.3/16
2 1/4	1	K9806Z-2.1/4
2 5/16	1	K9806Z-2.5/16
2 3/8	1	K9806Z-2.3/8
2 7/16	1	K9806Z-2.7/16
2 1/2	1	K9806Z-2.1/2
2 9/16	1	K9806Z-2.9/16
2 5/8	1	K9806Z-2.5/8
2 11/16	1	K9806Z-2.11/16
2 3/4	1	K9806Z-2.3/4
2 13/16	1	K9806Z-2.13/16
2 7/8	1	K9806Z-2.7/8
2 15/16	1	K9806Z-2.15/16
3	1	K9806Z-3
3 1/16	1	K9806Z-3.1/16
3 1/8	1	K9806Z-3.1/8
3 3/16	1	K9806Z-3.3/16
3 1/4	1	K9806Z-3.1/4
3 5/16	1	K9806Z-3.5/16
3 3/8	1	K9806Z-3.3/8
3 7/16	1	K9806Z-3.7/16
3 1/2	1	K9806Z-3.1/2
3 9/16	1	K9806Z-3.9/16
3 5/8	1	K9806Z-3.5/8
3 11/16	1	K9806Z-3.11/16
3 3/4	1	K9806Z-3.3/4
3 13/16	1	K9806Z-3.13/16
3 7/8	1	K9806Z-3.7/8
3 15/16	1	K9806Z-3.15/16
4	1	K9806Z-4
4 1/16	1	K9806Z-4.1/16
4 1/8	1	K9806Z-4.1/8
4 1/4	1	K9806Z-4.1/4
4 5/16	1	K9806Z-4.5/16
4 3/8	1	K9806Z-4.3/8
4 1/2	1	K9806Z-4.1/2
4 5/8	1	K9806Z-4.5/8
4 3/4	1	K9806Z-4.3/4



Alargadera de impacto 1.1/2"



K9860H

mm	Icon	Part
200		1 K9860H-1
380		1 K9860H-2
505		1 K9860H-3

Articulación universal de impacto cardan 1.1/2"



K9867S

mm	Icon	Part
1 1/2		1 K9867S
1 1/2		

Adaptador de impacto



K9598H/K9998H

mm	Icon	Part
1		1 K9598H
2 1/2		
1 1/2		1 K9998H
1 1/2		1 K9899H

Muelle de fijación



K560F-9

mm	Icon	Part
1 1/2"		5 K560F-9
95-120		

Caja de repuesto vacía



SPARE-CASE

mm	Icon	Part
35 x 80 x 100 mm		1 SPAR-CASE-A7
35 x 85 x 160 mm		1 SPAR-CASE-A6
46 x 130 x 195 mm		1 SPAR-CASE-A5
49 x 152 x 280 mm		1 SPAR-CASE-A4

CAJAS VACÍAS PARA JUEGOS DE VASOS

Cajas vacías para juegos de vasos



LLAVES DE CARRACA PARA ESTRUCTURAS

Llave a carraca de doble boca para estructuras



SC2RM

mm	Icon	Part
13-17		10 SC2RM-13-17
15-17		10 SC2RM-15-17
19-22		5 SC2RM-19-22
27-30		1 SC2RM-27-30

-CASE

mm	g	Part
110 x 375 x 430 mm	2200	1 S103-CASE
110 x 375 x 430 mm	2200	1 S106-CASE
70 x 160 x 280 mm	520	1 S160-CASE
70 x 160 x 280 mm	520	1 S290-CASE
70 x 160 x 280 mm	500	1 S330-CASE
110 x 320 x 375 mm	1620	1 S400-CASE
110 x 320 x 375 mm	1620	1 S410-CASE
100 x 215 x 375 mm	1120	1 S460-CASE
100 x 215 x 375 mm	1120	1 S560-CASE
110 x 375 x 430 mm	2200	1 S800-CASE
110 x 375 x 430 mm	2200	1 S81MIX-CASE
110 x 375 x 430 mm	2200	1 S87+7-CASE
110 x 320 x 375 mm	1620	1 S910-CASE
110 x 375 x 430 mm	2200	1 S108-CASE
110 x 375 x 430 mm	2200	1 SLX17-CASE
110 x 370 x 430 mm	2160	1 S138-CASE
100 x 215 x 375 mm	1120	1 S330L-CASE



Herramientas dinamométricas

LLAVES DINAMOMÉTRICAS MECÁNICAS

Llave dinamométrica mecánica de disparo de accionamiento libre ajustable con cabeza fija de carraca



75R3/75R1

Nm	lb-ft	in	
130-650 Nm	100-480 lb-ft	3/4"	1 75R3-650
200-800 Nm	150-600 lb-ft	3/4"	1 75R3-800
300-1000 Nm	220-750 lb-ft	3/4"	1 75R3-1000
500-1500 Nm	370-1100 lb-ft	1"	1 75R1-1500

Llave dinamométrica mecánica de disparo de accionamiento libre ajustable con cabeza con conexión cilíndrica intercambiable



75S-650

Nm	lb-ft	mm	
130-650 Nm	100-480 lb-ft	22	1 75S-650

Llave dinamométrica mecánica de disparo ajustable con escala marcada y cabeza fija de carraca
Mango de metal



7455

Nm	lb-ft	lb-in	
1-5	11-42		1 7455-5
3-15	31-128		1 7455-15
4-20	40-173		1 7455-20
5-25	49-217		1 7455-25
10-60		9.2-42.4	1 7455-60
20-100		16.6-71.9	1 7455-100
20-100 Nm		16.6-71.9 lb-ft	1 7455-100A
40-200		37-140	1 7455-200

Nm	lb-ft	lb-in	
60-300		52-314	1 7455-300
60-340		52-243	1 7455-340
100-500		83-359.6	1 7455-500
150-800		129-572	1 7455-800
200-1000 Nm		184-701 lb-ft	1 7455-1000

1/4" (7455-5); 3/8" (15-100); 1/2" (200-340)

3/4" (500-800); 1" (1500-2500)

Llave dinamométrica mecánica de disparo ajustable con escala marcada, cabeza fija de carraca y mango de dos secciones



7455-1500

Nm	lb-ft	in	
300-1500	258-1069	1 in	1 7455-1500

Llave dinamométrica mecánica de disparo ajustable con escala marcada y cabeza de cuadrado fijo



7455-2500

Nm	lb-ft	in	
500-2500	406-1807	1 in	1 7455-2500

Cuadrado 1"

Llave dinamométrica mecánica de disparo ajustable con escala marcada y cabeza intercambiable



7465

Nm	lb-ft	lb-in	
1-5 Nm		11-42 lb-in	1 7465-5
3-15 Nm		31-128 lb-in	1 7465-15
6-30 Nm		53-265 lb-in	1 7465-30
10-60 Nm		9.2-42.4 lb-ft	1 7465-60
20-100 Nm		16.6-71.9 lb-ft	1 7465-100
40-200 Nm		37-140 lb-ft	1 7465-200

60-340 Nm	52-243 lb-ft		1	7465-340
150-800 Nm	129-572 lb-ft		1	7465-800

Llave dinamométrica mecánica de disparo ajustable con escala marcada, cabeza intercambiable y mango de dos secciones



7465-1500

300-1500 Nm	258-1069 lb-ft	27x36 mm	1	7465-1500

Llave dinamométrica mecánica de disparo ajustable con escala marcada y cabeza de carraca flexible
Mango de metal



7456

10-80	3/8 in	0.5	1	7456-80LB

Libras pulgada 120-960

Llave dinamométrica mecánica articulada ajustable de disparo con visor de escala y cabeza fija de carraca



76R3

120-600 Nm	100-450 lb-ft	3/4 in	1	76R3-600
200-800 Nm	150-600 lb-ft	3/4 in	1	76R3-800
300-1000 Nm	200-750 lb-ft	3/4 in	1	76R3-1000

Llave dinamométrica mecánica de flexión de disparo con visor y cabeza intercambiable con conexión cilíndrica



76S-600

120-600 Nm	100-450 lb-ft	22	1	76S-600

Llave dinamométrica mecánica de disparo ajustable con visor y cabeza fija de carraca



74WR-15/74WR-25

3-15 Nm	27-132 lb-in	1/4 in	1	74WR-15
5-25 Nm	44-220 lb-in	1/4 in	1	74WR-25

Llave dinamométrica mecánica de disparo ajustable con visor y cabeza de carraca fija con cuadradillo pasante



74WR-50/74WR-400

10-50 Nm	7.5-37.5 lb-ft	3/8"	1	74WR-50
20-100 Nm	15-75 lb-ft	1/2"	1	74WR-100
40-200 Nm	30-150 lb-ft	1/2"	1	74WR-200
60-300 Nm	45-220 lb-ft	1/2"	1	74WR-300
60-340 Nm	45-250 lb-ft	1/2"	1	74WR-340
80-400 Nm	60-300 lb-ft	3/4"	1	74WR-400



Llave dinamométrica de disparo mecánica ajustable con visor y cabeza intercambiable de conexión cilíndrica



74WS-15/74WS-300

Nm		lb-in		lb-ft		in	
3-15 Nm		27-132 lb-in		1		74WS-15	
5-25 Nm		44-220 lb-in		1		74WS-25	
10-50 Nm	7.5-37.5 lb-ft			1		74WS-50	
20-100 Nm	15-75 lb-ft			1		74WS-100	
40-200 Nm	30-150 lb-ft			1		74WS-200	
60-300 Nm	45-220 lb-ft			1		74WS-300	

Llave dinamométrica de disparo mecánica ajustable con visor y cabeza intercambiable de conexión rectangular



74W9/74W14

Nm		lb-in		lb-ft		in	
3-15 Nm		27-132 lb-in		1		74W9-15	
5-25 Nm		44-220 lb-in		1		74W9-25	
10-50 Nm	7.5-37.5 lb-ft			1		74W9-50	
20-100 Nm	15-75 lb-ft			1		74W9-100	
40-200 Nm	30-150 lb-ft			1		74W9-200	
40-200 Nm	30-150 lb-ft			1		74W14-200	
60-300 Nm	45-220 lb-ft			1		74W14-300	
80-400 Nm	60-300 lb-ft			1		74W14-400	

Llave dinamométrica mecánica de dial, cuadradillo fijo y mango de plástico
Doble escala



7454

Nm		lb-in		lb-ft		in	
0.7-3.5		6-30		1		7454-3	
1.8-9		14-75		1		7454-9	
3.5-18		30-150		1		7454-18	
7-35		60-300		1		7454-35	
14-70		10-50		1		7454-70	

Nm		lb-in		lb-ft		in	
28-140		20-100		1		7454-140	
48-240		35-175		1		7454-240	

Llave dinamométrica mecánica de dial, cuadradillo fijo y mango de metal



7454-480/7454-800

Nm		lb-in		lb-ft		in	
100-480		70-350		3/4 in		1	7454-480
160-800		120-600		3/4 in		1	7454-800

Llave dinamométrica mecánica con dial, cuadradillo fijo y mango de dos secciones

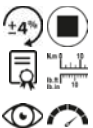

7454-1400

Nm		lb-in		lb-ft		in	
275-1400		200-1000		1 in		1	7454-1400

Llave dinamométrica mecánica con dial/LED y cuadradillo fijo



7454-800E

Nm		lb-in		lb-ft		in	
160-800		0-600		3/4 in		1	7454-800E

Llave dinamométrica mecánica con dial/LED, cuadradillo fijo y mango de dos secciones



7454-1400E

275-1400	200-1000	1 in	1	7454-1400E

Llave dinamométrica mecánica de disparo prefijada con cabeza fija de carraca



74PR-20

4-20 Nm	1/4 in	219	1	74PR-20

Llave dinamométrica mecánica de disparo prefijada con cabeza fija de carraca con cuadradillo por ambos lados



74PR-60/74PR-400

12-60 Nm	3/8 in	295	1	74PR-60
12-60 Nm	1/2 in	301	1	74PR-60A
20-100 Nm	3/8 in	335	1	74PR-100
20-100 Nm	1/2 in	342	1	74PR-100A
40-200 Nm	1/2 in	425	1	74PR-200
60-300 Nm	1/2 in	668	1	74PR-300
80-400 Nm	3/4 in	675	1	74PR-400

Llave dinamométrica mecánica prefijada con cabeza intercambiable de conexión cilíndrica y mango de plástico



74PS-20

4-20 Nm	16	206	1	74PS-20

Llave dinamométrica mecánica prefijada con cabeza intercambiable de conexión cilíndrica y mango de goma



74PS-60/74PS-300

12-60 Nm	16	283	1	74PS-60
20-100 Nm	16	324	1	74PS-100
40-200 Nm	16	405	1	74PS-200
60-300 Nm	16	643	1	74PS-300

Llave dinamométrica mecánica prefijada con cabeza intercambiable de conexión rectangular y mango de plástico



74P9-20

4-20 Nm	9x12 mm	205	1	74P9-20



Llave dinamométrica mecánica prefijada con cabeza intercambiable de conexión rectangular y mango de goma



74P9-60/74P14-400

Nm	mm	L		
12-60 Nm	9x12 mm	286	1	74P9-60
20-100 Nm	9x12 mm	326	1	74P9-100
40-200 Nm	14x18 mm	403	1	74P14-200
60-300 Nm	14x18 mm	534	1	74P14-300
80-400 Nm	14x18 mm	652	1	74P14-400

Llave dinamométrica mecánica de disparo de accionamiento libre prefijada con cabeza fija de carraca



75P3/75P1

Nm	in	L		
130-650 Nm	3/4" in	848	1	75P3-650
200-800 Nm	3/4" in	1030	1	75P3-800
300-1000 Nm	3/4" in	1238	1	75P3-1000
500-1500 Nm	1" in	1563	1	75P1-1500

Llave dinamométrica mecánica de disparo de accionamiento libre prefijada con cabeza con conexión cilíndrica intercambiable



75PS-650

Nm	mm	L		
130-650 Nm	22	800	1	75PS-650

Extensión para llaves de serie 75



75EXT

L	mm	kg		
700	60 mm	1.600 kg	1	75EXT

LLAVES DINAMOMÉTRICAS DIGITALES

Llave dinamométrica electrónica con cabeza intercambiable con conexión rectangular
Se suministra con la carraca



IZO-D

Nm	in-lb	ft-lb		
3-30 Nm	26.6-265.5 lb-in	2.21-22.13 lb-ft	1	IZO-D-30
13.5-135 Nm	62-1195 lb-in	10-99.57 lb-ft	1	IZO-D-135
20-200 Nm	177-1770 lb-in	14.75-147.50 lb-ft	1	IZO-D-200
34-340 Nm	301-3009 lb-in	25.07-250.80 lb-ft	1	IZO-D-340

IZOD-30: 1/4" - 9x12; D135: 3/8" - 9x12

IZO D-200: 1/2" 14x18; IZOD-340: 1/2" 14x18

Llave dinamométrica electrónica con cabeza fija de carraca
Cabeza de carraca 3/4"



IZO-DR

Nm	in-lb	ft-lb		
81-810	716.9-7169	59.74-5974.2	1	IZO-DR-810

Llave dinamométrica electrónica de par y grados y cabeza intercambiable rectangular



TAW9

Nm		lb-in		lb-ft		Caja		Pescado	
7-135	Nm	62-1194	lb-in	5.2-99.5	lb-ft	1	TAW9135		
17-340	Nm	150.5-3009	lb-in	12.5-250	lb-ft	1	TAW14340		
40-800	Nm	354-7080	lb-in	29.5-590	lb-ft	1	TAW24800		

Llave dinamométrica electrónica de par y grados y cabeza de carraca fija



TAW1430M/TAW1412M

Nm		lb-in		lb-ft		Caja		Pescado	
0.6-12	Nm	4.4-88	lb-in	0.37-7.38	lb-ft	1	TAW1412M		
1.5-30	Nm	13.2-265	lb-in	1.1-22.1	lb-ft	1	TAW1430M		

Llave dinamométrica electrónica de par y grados y cabeza de carraca fija
Cuerpo metálico



TAW

Nm		lb-in		lb-ft		Caja		Pescado	
7-135	Nm	62-1194	lb-in	5.2-99.5	lb-ft	1	TAW38135		
17-340	Nm	150.5-3009	lb-in	12.5-250	lb-ft	1	TAW12340		
40-800	Nm	354-7080	lb-in	29.5-590	lb-ft	1	TAW34800		

Llave dinamométrica electrónica de par y grados, con memoria/USB y cabeza intercambiable rectangular



TAWM9

Nm		lb-in		lb-ft		Caja		Pescado	
7-135	Nm	62-1194	lb-in	5.2-99.5	lb-ft	1	TAWM9135		
17-340	Nm	150.5-3009	lb-in	12.5-250	lb-ft	1	TAWM14340		
40-800	Nm	354-7080	lb-in	29.5-590	lb-ft	1	TAWM24800		

Llave dinamométrica electrónica de par y grados y cabeza intercambiable rectangular



TAW930M/TAW912M

Nm		lb-ft		lb-in		Caja		Pescado	
0.6-12	Nm	4.4-88	lb-ft	0.37-7.38	lb-in	1	TAW912M		
1.5-30	Nm	1.1-22.1	lb-ft	13.2-265	lb-in	1	TAW930M		

Llave dinamométrica electrónica de par y grados, con memoria/USB y cabeza de carraca fija
Cuerpo metálico



TAWM

Nm		lb-in		lb-ft		Caja		Pescado	
7-135	Nm	62-1194	lb-in	5.2-99.5	lb-ft	1	TAWM38135		
17-340	Nm	150.5-3009	lb-in	12.5-250	lb-ft	1	TAWM12340		
40-800	Nm	354-7080	lb-in	29.5-590	lb-ft	1	TAWM34800		



Llave dinamométrica electrónica de par y grados, con memoria/USB y cabeza intercambiable rectangular



TAWM930M/TAWM912M

Nm		lb-in		lb-ft			
0.6-12	5.3-106	0.44-8.85	1	TAWM912M			
1.5-30	13.2-265	1.1-22.1	1	TAWM930M			

Llave dinamométrica electrónica de par y grados, con memoria/USB y cabeza de carraca fija



TAWM1430M/TAWM1412M

Nm		lb-in		lb-ft			
0.6-12	0.44-8.85	5.3-106	1	TAWM1412M			
1.5-30	13.2-265	1.1-22.1	1	TAWM1430M			

ADAPTADORES DE PAR Y ÁNGULO

Goniómetro con imán



7851-M/8951-M

in	L		
1/2 in	490	1	7851-M
3/4 in	490	1	8951-M

Goniómetro con pinza



7851-G

in	L		
1/2 in	555	1	7851-G

Goniómetro electrónico



MAM

°		
0-360	1	MAM50M

Señal visual y de audio con 1 LED roja y 5 verdes

Adaptador electrónico de ángulo y par
Señal visual y audio: dos LED rojas y 10 verdes



TAM

Nm		lb-in		lb-ft			
1,5-30	13-266	1-22	1	TAM1430			
6,8-135	60-1194	5-100	1	TAM38135			
6,8-135	60-1194	5-100	1	TAM12135			
10-200	88,5-1770	7,4-147,5	1	TAM12200			
17-340	150,5-3009	12,5-251	1	TAM12340			

1/4" (TAM1430); 3/8" (TAM38135)

1/2" (TAM12135, 12200, 12340)

DESTORNILLADORES DINAMOMÉTRICOS

Destornillador dinamoétrico angular electrónico



TAS14

0.45-9 Nm	45-900 cNm	4-80 lb-in	1	TAS14H09
0.45-9 Nm	45-900 cNm	4-80 lb-in	1	TAS14S09

Destornillador dinamoétrico ajustable con visor de escala



6973N-6978N

10-80 cNm	1/4 in	1/4 in	1	6973N
40-200 cNm	1/4 in	1/4 in	1	6976N
50-450 cNm	1/4 in	1/4 in	1	6978N

Destornillador dinamoétrico ajustable con escala marcada en cN.m



TSS120

10-120 cNm	1/4 in	1	1	TSS120

Destornillador dinamoétrico ajustable con escala marcada en N.m



TSS600

1-6 Nm	1/4 in	0.1	1	TSS600

Mini llave dinamoétrica ajustable con punta fija



6852-5

1-5	1/4 in	0.1	1	6852-5

Set de mini llave dinamoétrica ajustable con punta fija



6852-5/S17

3.295 kg	1	6852-5/S17

KM653-QR	
6852-5	
6700SM-4	
59S/PH0, 59S/PH1	
59S/PZ0, 59S/PZ1	
59S/H1.5	
59S/0.8-5.5, 59S/0.6-4.5	
59S/T6, 59S/T7, 59S/T8	



Destornillador dinámico preajustable con visor de escala



6873N-6880N

cNM	in	in		
7-70 cNM	1/4 in	1/4 in	1	6876N
15-170 cNM	1/4 in	1/4 in	1	6878N
45-450 cNM	1/4 in	1/4 in	1	6880N

Mini llave dinámico prefijada con punta fija



6852P-5

Nm	in	L		
1-5 Nm	1/4" in	157	1	6852P-5

Mini llave dinámico prefijada de 1/4"



7453

Nm	in	in		
2-20	1/4 in	- in	1	7453-20-6F
2-20	- in	1/4 in	1	7453-20-6

7453-20-6F: cuadrado hembra

Destornillador dinámico ERGO™ de par prefijado
Con cuchillas TORX® y TORX Plus®



BE-6990

max	T6	IP6		
0.6	T6	IP6	1	BE-6990-IP6
0.9	T7	IP7	1	BE-6990-IP7
1.2	T8	IP8	1	BE-6990-IP8
1.4	T9	IP9	1	BE-6990-IP9
2	T10	IP10	1	BE-6990-IP10
3	T15	IP15	1	BE-6990-IP15

Juego de destornillador dinámico par prefijado ERGO™
con varillas intercambiables



BE-6990-IPSET

kg		
0.755 kg	1	BE-6990-IPSET

BE-6990-IP7, BE-6990-IP8, BE-6990-IP9, BE-6990-IP15

Varilla TORX® para destornillador dinámico BE-6990



BE-6990TX-KL



T6	1.70	160	10	BE-6990TX-T6-KL
T7	1.99	160	10	BE-6990TX-T7-KL
T8	2.31	160	10	BE-6990TX-T8-KL
T9	2.50	170	10	BE-6990TX-T9-KL
T10	2.74	170	10	BE-6990TX-T10KL
T15	3.27	170	10	BE-6990TX-T15KL

Varilla TORX® Plus para destornillador dinámico BE-6990



BE-6990-IP-KL



IP6	1.50	170	10	BE-6990-IP6-KL
IP7	1.99	170	10	BE-6990-IP7-KL
IP8	2.31	170	10	BE-6990-IP8-KL
IP9	2.50	170	10	BE-6990-IP9-KL
IP10	2.74	170	10	BE-6990-IP10-KL
IP15	3.27	170	10	BE-6990-IP15-KL

Varilla TORX® Plus para destornillador dinámico BE-6990



BE-6990-IP20-KL

IP20	4.5	90	10	BE-6990-IP20-KL

Varilla de recambio para puntas TORX®



BE-6990TX-T20KL

T20	4.5	92	10	BE-6990TX-T20KL

COMPROBADORES DE PAR

Comprobador de par multifunción



TEA

10-350 Nm	89-3098 lb-in	7.4-258.1 lb-ft	1	TEA350
50-1100 Nm	443-9736 lb-in	36.9-811.3 lb-ft	1	TEA1100

*TEA1100: hexágono macho de 27mm



HERRAMIENTAS DE INSERCIÓN

Adaptador para cabezas intercambiables con conector rectangular



9/14/24/27A

mm	mm	L		
9x12 mm	14x18 mm	42	1	9A-14
14x18 mm	9x12 mm	27	1	14A-9
14x18 mm	24x32 mm	65	1	14A-32
24x32 mm	14x18 mm	42	1	24A-14
24x32 mm	27x36 mm	65	1	24A-27
27x36 mm	24x32 mm	65	1	27A-24

Cabeza intercambiable para soldar con conector rectangular



9/14/24W

mm	L		
9x12 mm	23	1	9W
14x18 mm	39	1	14W
24x32 mm	65	1	24W

Cabeza intercambiable redonda de carraca reversible con conector rectangular



9/14/24/27R

in	mm	máx		
1/4 in	9x12 mm	30	1	9R-1/4
3/8 in	9x12 mm	135	1	9R-3/8

in	mm	máx		
1/2 in	9x12 mm	160	1	9R-1/2
1/2 in	14x18 mm	340	1	14R-1/2
3/4 in	14x18 mm	420	1	14R-3/4
3/4 in	24x32 mm	1000	1	24R-3/4
1 in	24x32 mm	1200	1	24R-1
1 in	27x36 mm	2500	1	27R-1

Cabeza intercambiable con cuadradillo pasante de carraca con conector rectangular



9/14/24/27T

in	mm		
1/4 in	9x12 mm	1	9T-1/4
3/8 in	9x12 mm	1	9T-3/8
1/2 in	9x12 mm	1	9T-1/2
1/2 in	14x18 mm	1	14T-1/2
3/4 in	14x18 mm	1	14T-3/4
3/4 in	24x32 mm	1	24T-3/4
1 in	24x32 mm	1	24T-1
1 in	27x36 mm	1	27T-1

Cabeza intercambiable de carraca tipo pera con conector rectangular



9/14P

in	mm		
1/4 in	9x12 mm	1	9P-1/4
3/8 in	9x12 mm	1	9P-3/8
1/2 in	9x12 mm	1	9P-1/2
1/2 in	14x18 mm	1	14P-1/2

Cabeza intercambiable de carraca tipo pera con liberación rápida y conector rectangular



9/14Q

in	mm		
1/4 in	9x12 mm	1	9Q-1/4
3/8 in	9x12 mm	1	9Q-3/8
1/2 in	9x12 mm	1	9Q-1/2
1/2 in	14x18 mm	1	14Q-1/2

Cabeza intercambiable de carraca portapuntas con conector rectangular



9B

in	mm		
1/4 in	9x12 mm	1	9B-1/4
5/16 in	9x12 mm	1	9B-5/16

Cabeza intercambiable cuadrada fija con conector rectangular



9/14/24/27F

in	mm		
1/4 in	9x12 mm	1	9F-1/4
3/8 in	9x12 mm	1	9F-3/8

in	mm		
1/2 in	9x12 mm	1	9F-1/2
1/2 in	14x18 mm	1	14F-1/2
3/4 in	14x18 mm	1	14F-3/4
3/4 in	24x32 mm	1	24F-3/4
1 in	24x32 mm	1	24F-1
1 in	27x36 mm	1	27F-1





Cabeza intercambiable de boca fija con conector rectangular métrica



9/14/24/277

in	mm	max		
7 in	9x12 mm	9	1	97-7
8 in	9x12 mm	13	1	97-8
9 in	9x12 mm	18	1	97-9
10 in	9x12 mm	24	1	97-10
11 in	9x12 mm	32	1	97-11
12 in	9x12 mm	41	1	97-12
13 in	9x12 mm	51	1	97-13
14 in	9x12 mm	63	1	97-14
15 in	9x12 mm	77	1	97-15
16 in	9x12 mm	92	1	97-16
17 in	9x12 mm	109	1	97-17
18 in	9x12 mm	125	1	97-18
19 in	9x12 mm	145	1	97-19
21 in	9x12 mm	160	1	97-21
22 in	9x12 mm	160	1	97-22
24 in	9x12 mm	160	1	97-24
27 in	9x12 mm	160	1	97-27
30 in	9x12 mm	160	1	97-30
32 in	9x12 mm	160	1	97-32
13 in	14x18 mm	51	1	147-13
14 in	14x18 mm	63	1	147-14
15 in	14x18 mm	77	1	147-15
16 in	14x18 mm	92	1	147-16
17 in	14x18 mm	109	1	147-17
18 in	14x18 mm	125	1	147-18
19 in	14x18 mm	145	1	147-19
21 in	14x18 mm	190	1	147-21
22 in	14x18 mm	220	1	147-22
24 in	14x18 mm	280	1	147-24
25 in	14x18 mm	320	1	147-25
27 in	14x18 mm	360	1	147-27
30 in	14x18 mm	360	1	147-30
32 in	14x18 mm	360	1	147-32
33 in	14x18 mm	360	1	147-33
34 in	14x18 mm	360	1	147-34
35 in	14x18 mm	360	1	147-35
36 in	14x18 mm	360	1	147-36
37 in	14x18 mm	360	1	147-37
38 in	14x18 mm	360	1	147-38
39 in	14x18 mm	360	1	147-39
41 in	14x18 mm	360	1	147-41
45 in	14x18 mm	360	1	147-45
46 in	14x18 mm	360	1	147-46
50 in	14x18 mm	360	1	147-50













				
in	mm	mm		
55 in	14x18 mm	360	1	147-55
60 in	14x18 mm	360	1	147-60
68 in	14x18 mm	360	1	147-68
70 in	14x18 mm	360	1	147-70
75 in	14x18 mm	360	1	147-75
90 in	14x18 mm	360	1	147-90
<hr/>				
24 in	24x32 mm	1200	1	247-24
27 in	24x32 mm	1200	1	247-27
30 in	24x32 mm	1200	1	247-30
32 in	24x32 mm	1200	1	247-32
34 in	24x32 mm	1200	1	247-34
36 in	24x32 mm	1200	1	247-36
41 in	24x32 mm	1200	1	247-41
46 in	24x32 mm	1200	1	247-46
50 in	24x32 mm	1200	1	247-50
55 in	24x32 mm	1200	1	247-55
60 in	24x32 mm	1200	1	247-60
<hr/>				
30 in	27x36 mm	3000	1	277-30
32 in	27x36 mm	3000	1	277-32
34 in	27x36 mm	3000	1	277-34
36 in	27x36 mm	3000	1	277-36
41 in	27x36 mm	3000	1	277-41
46 in	27x36 mm	3000	1	277-46
50 in	27x36 mm	3000	1	277-50
55 in	27x36 mm	3000	1	277-55
60 in	27x36 mm	3000	1	277-60

Cabeza intercambiable de boca fija con conector rectangular pulgadas



9/14/24/277"





				
in	mm	mm		
1/4 in	9x12 mm	6	1	97-1/4
5/16 in	9x12 mm	13	1	97-5/16
3/8 in	9x12 mm	24	1	97-3/8
7/16 in	9x12 mm	32	1	97-7/16
1/2 in	9x12 mm	51	1	97-1/2
17/32 in	9x12 mm	63	1	97-17/32
9/16 in	9x12 mm	77	1	97-9/16
5/8 in	9x12 mm	92	1	97-5/8
11/16 in	9x12 mm	125	1	97-11/16
3/4 in	9x12 mm	145	1	97-3/4
13/16 in	9x12 mm	160	1	97-13/16
7/8 in	9x12 mm	160	1	97-7/8
15/16 in	9x12 mm	160	1	97-15/16
1 in	9x12 mm	160	1	97-1
<hr/>				
7/16 in	14x18 mm	32	1	147-7/16
1/2 in	14x18 mm	51	1	147-1/2
9/16 in	14x18 mm	77	1	147-9/16
5/8 in	14x18 mm	92	1	147-5/8
11/16 in	14x18 mm	109	1	147-11/16
3/4 in	14x18 mm	145	1	147-3/4
13/16 in	14x18 mm	190	1	147-13/16
7/8 in	14x18 mm	220	1	147-7/8
15/16 in	14x18 mm	280	1	147-15/16
1 in	14x18 mm	360	1	147-1





				
in	mm	mm		
1 1/8 in	14x18 mm	360	1	147-1.1/8
1 1/4 in	14x18 mm	360	1	147-1.1/4

Cabeza intercambiable de boca estrella con conector rectangular métrica



9/14/24/278





				
mm	mm	mm		
7 mm	9x12 mm	25	1	98-7
8 mm	9x12 mm	34	1	98-8
9 mm	9x12 mm	45	1	98-9
10 mm	9x12 mm	58	1	98-10
11 mm	9x12 mm	47	1	98-11
12 mm	9x12 mm	89	1	98-12
13 mm	9x12 mm	105	1	98-13
14 mm	9x12 mm	125	1	98-14
15 mm	9x12 mm	145	1	98-15
16 mm	9x12 mm	160	1	98-16
17 mm	9x12 mm	160	1	98-17
18 mm	9x12 mm	160	1	98-18
19 mm	9x12 mm	160	1	98-19
21 mm	9x12 mm	160	1	98-21
22 mm	9x12 mm	160	1	98-22
<hr/>				
13 mm	14x18 mm	105	1	148-13
14 mm	14x18 mm	125	1	148-14
15 mm	14x18 mm	150	1	148-15
16 mm	14x18 mm	175	1	148-16
17 mm	14x18 mm	200	1	148-17
18 mm	14x18 mm	230	1	148-18
19 mm	14x18 mm	260	1	148-19
21 mm	14x18 mm	330	1	148-21
22 mm	14x18 mm	360	1	148-22
24 mm	14x18 mm	360	1	148-24
27 mm	14x18 mm	360	1	148-27
28 mm	14x18 mm	360	1	148-28
30 mm	14x18 mm	360	1	148-30
32 mm	14x18 mm	360	1	148-32
34 mm	14x18 mm	360	1	148-34
36 mm	14x18 mm	360	1	148-36
41 mm	14x18 mm	360	1	148-41
<hr/>				
24 mm	24x32 mm	1200	1	248-24
27 mm	24x32 mm	1200	1	248-27
30 mm	24x32 mm	1200	1	248-30
32 mm	24x32 mm	1200	1	248-32
34 mm	24x32 mm	1200	1	248-34
36 mm	24x32 mm	1200	1	248-36
41 mm	24x32 mm	1200	1	248-41
46 mm	24x32 mm	1200	1	248-46
50 mm	24x32 mm	1200	1	248-50
55 mm	24x32 mm	1200	1	248-55
60 mm	24x32 mm	1200	1	248-60
<hr/>				
30 mm	27x36 mm	3000	1	278-30
32 mm	27x36 mm	1240	1	278-32
34 mm	27x36 mm	3000	1	278-34
36 mm	27x36 mm	3000	1	278-36

				
41 mm	27x36 mm	3000	1	278-41
46 mm	27x36 mm	3000	1	278-46
50 mm	27x36 mm	3000	1	278-50
55 mm	27x36 mm	3000	1	278-55
60 mm	27x36 mm	3000	1	278-60

Cabeza intercambiable de boca estrella con conector rectangular pulgadas



9/14/24/278"





				
1/4 in	9x12 mm	25	1	98-1/4
5/16 in	9x12 mm	34	1	98-5/16
3/8 in	9x12 mm	58	1	98-3/8
7/16 in	9x12 mm	72	1	98-7/16
1/2 in	9x12 mm	105	1	98-1/2
9/16 in	9x12 mm	125	1	98-9/16
5/8 in	9x12 mm	160	1	98-5/8
11/16 in	9x12 mm	160	1	98-11/16
3/4 in	9x12 mm	57	1	98-3/4
13/16 in	14x18 mm	330	1	148-13/16
13/16 in	9x12 mm	160	1	98-13/16
7/8 in	9x12 mm	160	1	98-7/8
1/2 in	14x18 mm	105	1	148-1/2
9/16 in	14x18 mm	150	1	148-9/16
5/8 in	14x18 mm	175	1	148-5/8
11/16 in	14x18 mm	230	1	148-11/16
3/4 in	14x18 mm	260	1	148-3/4
15/16 in	14x18 mm	360	1	148-15/16
7/8 in	14x18 mm	360	1	148-7/8
1 in	14x18 mm	360	1	148-1

Cabeza intercambiable para racores con conector rectangular



99





				
10 mm		9x12 mm	1	99-10
11 mm		9x12 mm	1	99-11

				
12 mm		9x12 mm	1	99-12
13 mm		9x12 mm	1	99-13
14 mm		9x12 mm	1	99-14
16 mm		9x12 mm	1	99-16
17 mm		9x12 mm	1	99-17
18 mm		9x12 mm	1	99-18
19 mm		9x12 mm	1	99-19
21 mm		9x12 mm	1	99-21
22 mm		9x12 mm	1	99-22
24 mm		9x12 mm	1	99-24
	3/8 in	9x12 mm	1	99-3/8
	7/16 in	9x12 mm	1	99-7/16
	1/2 in	9x12 mm	1	99-1/2
	9/16 in	9x12 mm	1	99-9/16
	5/8 in	9x12 mm	1	99-5/8
	11/16 in	9x12 mm	1	99-11/16
	3/4 in	9x12 mm	1	99-3/4

Cabeza de carraca redonda intercambiable con conector cilíndrico







16R/22R

				
1/4" in	16	20	1	16R-1/4
3/8" in	16	160	1	16R-3/8
1/2" in	16	420	1	16R-1/2
3/4" in	22	1200	1	22R-3/4

Cabeza intercambiable de cuadradillo pasante con conector cilíndrico



16F/22F

				
1/4" in	16	20	1	16F-1/4
3/8" in	16	160	1	16F-3/8
1/2" in	16	420	1	16F-1/2
3/4" in	22	1200	1	22F-3/4



Cabeza intercambiable llave fija mm con conector cilíndrico



167/227

mm	mm	máx	
16	7 mm	9	1 167-7
16	8 mm	13	1 167-8
16	9 mm	18	1 167-9
16	10 mm	24	1 167-10
16	11 mm	32	1 167-11
16	12 mm	41	1 167-12
16	13 mm	51	1 167-13
16	14 mm	63	1 167-14
16	15 mm	77	1 167-15
16	16 mm	92	1 167-16
16	17 mm	109	1 167-17
16	18 mm	125	1 167-18
16	19 mm	145	1 167-19
16	20 mm	160	1 167-20
16	21 mm	190	1 167-21
16	22 mm	220	1 167-22
16	23 mm	250	1 167-23
16	24 mm	280	1 167-24
16	25 mm	320	1 167-25
16	26 mm	360	1 167-26
16	27 mm	360	1 167-27
16	28 mm	360	1 167-28
16	30 mm	360	1 167-30
16	32 mm	360	1 167-32
16	36 mm	360	1 167-36
22	22 mm	1200	1 227-22
22	24 mm	1200	1 227-24
22	27 mm	1200	1 227-27
22	30 mm	1200	1 227-30
22	32 mm	1200	1 227-32
22	34 mm	1200	1 227-34
22	36 mm	1200	1 227-36
22	41 mm	1200	1 227-41
22	46 mm	1200	1 227-46

Cabeza intercambiable llave fija pulgadas con conector cilíndrico



167

mm	in	máx	
16	5/16 in	34	1 167-5/16
16	3/8 in	45	1 167-3/8

mm	in	máx	
16	7/16 in	72	1 167-7/16
16	1/2 in	51	1 167-1/2
16	9/16 in	77	1 167-9/16
16	5/8 in	92	1 167-5/8
16	11/16 in	109	1 167-11/16
16	3/4 in	145	1 167-3/4
16	13/16 in	190	1 167-13/16
16	7/8 in	220	1 167-7/8
16	15/16 in	280	1 167-15/16
16	1 in	360	1 167-1
16	1.1/16 in	360	1 167-1.1/16
16	1.1/8 in	360	1 167-1.1/8
16	1.3/16 in	360	1 167-1.3/16
16	1.1/4 in	360	1 167-1.1/4

Cabeza intercambiable de boca estrella con conector cilíndrico métrica



168/228

mm	mm	máx	
16	7 mm	25	1 168-7
16	8 mm	34	1 168-8
16	9 mm	45	1 168-9
16	10 mm	58	1 168-10
16	11 mm	72	1 168-11
16	12 mm	89	1 168-12
16	13 mm	105	1 168-13
16	14 mm	125	1 168-14
16	15 mm	150	1 168-15
16	16 mm	175	1 168-16
16	17 mm	200	1 168-17
16	18 mm	230	1 168-18
16	19 mm	260	1 168-19
16	20 mm	290	1 168-20
16	21 mm	330	1 168-21
16	22 mm	360	1 168-22
16	23 mm	360	1 168-23
16	24 mm	360	1 168-24
16	26 mm	360	1 168-26
16	27 mm	360	1 168-27
22	22 mm	1200	1 228-22
22	24 mm	1200	1 228-24
22	27 mm	1200	1 228-27
22	30 mm	1200	1 228-30
22	32 mm	1200	1 228-32
22	34 mm	1200	1 228-34
22	36 mm	1200	1 228-36
22	41 mm	1200	1 228-41
22	46 mm	1200	1 228-46

Cabeza intercambiable de boca estrella con conector cilíndrico pulgadas



168

mm	in	máx		
16	5/16 in	34	1	168-5/16
16	3/8 in	58	1	168-3/8
16	7/16 in	89	1	168-7/16
16	1/2 in	105	1	168-1/2
16	9/16 in	125	1	168-9/16
16	5/8 in	125	1	168-5/8
16	11/16 in	125	1	168-11/16
16	3/4 in	260	1	168-3/4
16	13/16 in	290	1	168-13/16
16	7/8 in	360	1	168-7/8
16	15/16 in	360	1	168-15/16
16	1 in	360	1	168-1
16	1.1/16 in	360	1	168-1.1/16
16	1.3/16 in	360	1	168-1.3/16

Cabeza intercambiable para racores con conector cilíndrico



169

mm	mm	máx		
16	7 mm	6	1	169-7
16	8 mm	8	1	169-8
16	9 mm	10	1	169-9
16	10 mm	12	1	169-10
16	11 mm	16	1	169-11
16	12 mm	16	1	169-12
16	13 mm	28	1	169-13
16	14 mm	31	1	169-14
16	15 mm	38	1	169-15
16	16 mm	46	1	169-16
16	17 mm	53	1	169-17
16	18 mm	65	1	169-18
16	19 mm	74	1	169-19
16	20 mm	86	1	169-20

mm	mm	máx		
16	21 mm	100	1	169-21
16	22 mm	115	1	169-22
16	23 mm	125	1	169-23
16	24 mm	145	1	169-24
16	27 mm	160	1	169-27

MULTIPLICADORES

Multiplicador de par manual con compensación con brazos de reacción recto y acodado



89049TM-1000

MAX Nm	in			
1000 Nm	1/2 in	4.8:1/4.9:1*	1	89049TM-1000

Multiplicador de par manual con compensación con brazos de reacción recto y acodado



8905-TM/9505-TM

MAX Nm	in			
1300	3/4 in	5:1	1	8905-TM
2700	1 in	5:1	1	9505-TM



Multiplicador de par manual con placa de reacción



9505/9605/9525/9625

MAX Nm	in			
3400	3/4 in	5:1	1	9505-3400
3400	1/2 in	25:1	1	9525-3400
9500	3/4 in	25:1	1	9625-9500

Multiplicador de par manual con brazo de reacción recto



95155B/9526B

MAX Nm	in			
3000	1/2 in	15.5:1	1	95155B-3000
4500	1/2 in	26:1	1	9526B-4500

Multiplicador de par manual compacto con brazo de reacción acodado



89222CR/96255CR

MAX Nm	in			
1000	1/2 in	22.2:1	1	89222CR-1000
2000	1/2 in	27:1	1	9527CR-2000
4000	1/2 in	25:1	1	9525CR-4000
7000	1/2 in	25.5:1	1	96255CR-7000

SISTEMAS DE APRIETE VERIFICADO

Control inalámbrico para llave dinamométrica prefijada



WPCU2S

	kg		
E	1.150 kg	1	WPCU2S
G	1.150 kg	1	WPCU2S-UK
I	1.150 kg	1	WPCU2S-AUS
A	1.150 kg	1	WPCU2S-US

Llave dinamométrica mecánica de disparo de par prefijado con control inalámbrico y cabeza intercambiable de conexión rectangular



WPTC

	mm	L		
1-5 Nm	9x12 mm	176	1	WPTC-5
3-15 Nm	9x12 mm	176	1	WPTC-15
5-25 Nm	9x12 mm	227	1	WPTC-25
10-60 Nm	9x12 mm	324	1	WPTC-60
20-100 Nm	9x12 mm	324	1	WPTC-100
40-200 Nm	14x18 mm	411	1	WPTC-200
60-300 Nm	14x18 mm	528	1	WPTC-300

WPTC-300: bajo demanda



Accesorios para herramientas eléctricas



CORONAS DE SIERRA

Juego de 4 coronas de sierra
+ soporte de corona



3834-42



2025

1 3834-SET-42

3830-51-VIP, 3830-76-VIP, 3830-86-VIP, 3830-111-VIP



3834-ARBR-9100



3834-ES



Juego de 11 coronas de sierra
+ soporte para coronas



3834-53



2370

1 3834-SET-53

3830-19-VIP, 3830-22-VIP, 3830-25-VIP, 3830-29-VIP, 3830-30-VIP, 3830-35-VIP, 3830-37-VIP, 3830-41-VIP, 3830-52-VIP, 3830-60-VIP, 3830-79-VIP



3834-ARBR-930



3834-ARBR-9100



Juego de 6 coronas de sierra
+ soporte para coronas



3834-61



3145

1 3834-SET-61

3830-44-VIP, 3830-51-VIP, 3830-57-VIP, 3830-73-VIP, 3830-86-VIP, 3830-114-VIP



3834-ARBR-9100



Juego de 6 coronas de sierra
+ soportes de corona



3834-62



1050

1 3834-SET-62

3830-19-VIP, 3830-21-VIP, 3830-22-VIP, 3830-29-VIP, 3830-38-VIP, 3830-48-VIP



3834-ARBR-930



3834-ARBR-9100



Juego de 6 coronas de sierra
+ soportes de corona



3834-62-16/50



1065

1 3834-SET-62-16/50

3830-16-VIP, 3830-20-VIP, 3830-25-VIP, 3830-32-VIP, 3830-40-VIP, 3830-50-VIP



3834-ARBR-9100



3834-ARBR-930



Juego de 6 coronas de sierra
+ soportes de corona



3834-65-16/51



1465

1 3834-SET-65-16/51

3830-16-VIP, 3830-20-VIP, 3830-25-VIP, 3830-32-VIP, 3830-40-VIP, 3830-51-VIP



3834-ARBR-1130



3834-ARBR-11152



3834-DRL



Juego de 6 coronas de sierra + soportes de corona



3834-65-22/64



1625

1 3834-SET-65-22/64

- 3830-22-VIP, 3830-29-VIP, 3830-35-VIP, 3830-44-VIP, 3830-51-VIP, 3830-64-VIP
- 3834-ARBR-1130
- 3834-ARBR-11152
- 3834-DRL

Juego de 7 coronas de sierra + soportes de corona



3834-72



1080

1 3834-SET-72

- 3830-19-VIP, 3830-22-VIP, 3830-29-VIP, 3830-35-VIP, 3830-44-VIP, 3830-51-VIP, 3830-64-VIP
- 3834-ARBR-930
- 3834-ARBR-9100

Juego de 7 coronas de sierra + soportes de corona



3834-73



2080

1 3834-SET-73

- 3830-16-VIP, 3830-22-VIP, 3830-51-VIP, 3830-57-VIP, 3830-73-VIP, 3830-76-VIP, 3830-92-VIP
- 3834-ARBR-930
- 3834-ARBR-9100

Juego de 7 coronas de sierra + soportes de coronas



3834-73-22/68



2170

1 3834-SET-73-22/68

- 3830-22-VIP, 3830-29-VIP, 3830-35-VIP, 3830-44-VIP, 3830-51-VIP, 3830-64-VIP, 3830-68-VIP
- 3834-ARBR-1130
- 3834-ARBR-11152
- 3834-DRL

Juego de 10 coronas de sierra + soportes de corona



3834-SET-77



3325

1 3834-SET-77

- 3830-16-VIP, 3830-20-VIP, 3830-25-VIP, 3830-32-VIP, 3830-41-VIP, 3830-51-VIP, 3830-73-VIP, 3830-76-VIP, 3830-83-VIP, 3830-86-VIP
- 3834-ARBR-930
- 3834-ARBR-9100
- 3834-DRL

Juego de 8 coronas de sierra + soportes de corona



3834-86



2540

1 3834-SET-86

- 3830-25-VIP, 3830-32-VIP, 3830-35-VIP, 3830-51-VIP, 3830-54-VIP, 3830-76-VIP, 3830-92-VIP, 3830-114-VIP
- 3834-ARBR-1130
- 3834-ARBR-11152
- 2x 3834-DRL
- 3834-ADP



Juego de 8 coronas de sierra + soportes de corona



3834-87

1925	1	3834-SET-87

3830-19-VIP, 3830-22-VIP, 3830-29-VIP, 3830-38-VIP, 3830-43-VIP, 3830-48-VIP, 3830-52-VIP, 3830-65-VIP	
3834-ARBR-930	
3834-ARBR-9100	
3834-DRL	
3834-ES	

Juego de 9 coronas de sierra + soportes de corona



3834-92

1440	1	3834-SET-92

3830-16-VIP, 3830-22-VIP, 3830-25-VIP, 3830-29-VIP, 3830-32-VIP, 3830-41-VIP, 3830-51-VIP, 3830-73-VIP, 3830-83-VIP	
3834-ARBR-930	
3834-ARBR-9100	

Juego de 9 coronas de sierra + soportes de corona



3834-94

1815	1	3834-SET-94

3830-16-VIP, 3830-19-VIP, 3830-22-VIP, 3830-25-VIP, 3830-30-VIP, 3830-35-VIP, 3830-41-VIP, 3830-51-VIP, 3830-67-VIP	
3834-ARBR-1130	
3834-ARBR-11152	

Juego de 9 coronas de sierra + soportes de corona



3834-95

1350	1	3834-SET-95

3830-16-VIP, 3830-19-VIP, 3830-22-VIP, 3830-29-VIP, 3830-35-VIP, 3830-44-VIP, 3830-52-VIP, 3830-57-VIP, 3830-64-VIP	
3834-ARBR-1130	
3834-ARBR-11152	
3834-DRL	

Juego de 8 coronas bimetetal + soportes



3834-103

2015	1	3834-SET-103

3830-16-VIP, 3830-19-VIP, 3830-24-VIP, 3830-29-VIP, 3830-38-VIP, 3830-44-VIP, 3830-57-VIP, 3830-67-VIP	
3834-ARBR-1130	
3834-ARBR-11152	
3834-DRL	

Juego de 15 coronas de sierra + soporte para coronas



3834-SET-152

3770	1	3834-SET-152

3830-16-VIP, 3830-19-VIP, 3830-22-VIP, 3830-25-VIP, 3830-32-VIP, 3830-35-VIP, 3830-44-VIP, 3830-51-VIP, 3830-57-VIP, 3830-60-VIP, 3830-65-VIP, 3830-68-VIP, 3830-73-VIP, 3830-76-VIP, 3830-83-VIP	
3834-ARBR-930	
3834-ARBR-9100	
3834-DRL	

Corona de sierra Sandflex®, bi-metal



3830

14	1	3830-14-C
16	1	3830-16-C
17	1	3830-17-C
19	1	3830-19-C
20	1	3830-20-C
21	1	3830-21-C
22	1	3830-22-C
24	1	3830-24-C
25	1	3830-25-C
27	1	3830-27-C
29	1	3830-29-C
30	1	3830-30-C
32	1	3830-32-C
33	1	3830-33-C
35	1	3830-35-C
37	1	3830-37-C
38	1	3830-38-C
40	1	3830-40-C
41	1	3830-41-C
43	1	3830-43-C
44	1	3830-44-C
46	1	3830-46-C
48	1	3830-48-C
50	1	3830-50-C
51	1	3830-51-C
52	1	3830-52-C
54	1	3830-54-C
55	1	3830-55-C
56	1	3830-56-C
57	1	3830-57-C
59	1	3830-59-C
60	1	3830-60-C
64	1	3830-64-C
65	1	3830-65-C
67	1	3830-67-C
68	1	3830-68-C
70	1	3830-70-C
73	1	3830-73-C
76	1	3830-76-C
79	1	3830-79-C
83	1	3830-83-C
86	1	3830-86-C
89	1	3830-89-C
92	1	3830-92-C
95	1	3830-95-C
98	1	3830-98-C
102	1	3830-102-C
105	1	3830-105-C
108	1	3830-108-C

111	1	3830-111-C
114	1	3830-114-C
121	1	3830-121-C
127	1	3830-127-C
133	1	3830-133-C
140	1	3830-140-C
146	1	3830-146-C
152	1	3830-152-C
14	6	3830-14-VIP
16	6	3830-16-VIP
17	6	3830-17-VIP
19	6	3830-19-VIP
20	6	3830-20-VIP
21	6	3830-21-VIP
22	6	3830-22-VIP
24	6	3830-24-VIP
25	6	3830-25-VIP
27	6	3830-27-VIP
29	6	3830-29-VIP
30	6	3830-30-VIP
32	6	3830-32-VIP
33	6	3830-33-VIP
35	6	3830-35-VIP
37	6	3830-37-VIP
38	6	3830-38-VIP
40	6	3830-40-VIP
41	6	3830-41-VIP
43	6	3830-43-VIP
44	6	3830-44-VIP
46	6	3830-46-VIP
48	6	3830-48-VIP
50	6	3830-50-VIP
51	6	3830-51-VIP
52	4	3830-52-VIP
54	4	3830-54-VIP
55	4	3830-55-VIP
56	4	3830-56-VIP
57	4	3830-57-VIP
59	4	3830-59-VIP
60	4	3830-60-VIP
62	4	3830-62-VIP
64	4	3830-64-VIP
65	4	3830-65-VIP
67	4	3830-67-VIP
68	4	3830-68-VIP
70	4	3830-70-VIP
73	4	3830-73-VIP
76	4	3830-76-VIP
79	4	3830-79-VIP
83	4	3830-83-VIP
86	4	3830-86-VIP
89	4	3830-89-VIP
92	4	3830-92-VIP
95	4	3830-95-VIP
98	4	3830-98-VIP
102	4	3830-102-VIP
105	4	3830-105-VIP
108	4	3830-108-VIP
111	4	3830-111-VIP
114	4	3830-114-VIP
121	1	3830-121-VIP
127	1	3830-127-VIP
133	1	3830-133-VIP
140	1	3830-140-VIP
146	1	3830-146-VIP
152	1	3830-152-VIP
168	1	3830-168
177	1	3830-177-HIGH
210	1	3830-210

Corona de sierra, dentado con plaquitas de metal duro



3832

14	6	3832-14
16	6	3832-16
17	6	3832-17
19	6	3832-19
20	6	3832-20
21	6	3832-21
22	6	3832-22
24	6	3832-24
25	6	3832-25
27	6	3832-27
29	6	3832-29
30	6	3832-30
32	6	3832-32
33	6	3832-33
35	6	3832-35
37	6	3832-37
38	6	3832-38
40	6	3832-40
41	6	3832-41
43	6	3832-43
44	6	3832-44
46	6	3832-46
48	6	3832-48
51	6	3832-51
52	4	3832-52
54	4	3832-54
56	4	3832-56
57	4	3832-57
59	4	3832-59
60	4	3832-60
64	4	3832-64
65	4	3832-65
67	4	3832-67
68	4	3832-68
70	4	3832-70
73	4	3832-73
76	4	3832-76
79	4	3832-79
83	4	3832-83
86	4	3832-86
89	4	3832-89
92	4	3832-92
95	4	3832-95
98	4	3832-98
102	4	3832-102
105	4	3832-105
108	4	3832-108
111	4	3832-111
114	4	3832-114
121	1	3832-121
127	1	3832-127
133	1	3832-133
140	1	3832-140
146	1	3832-146
152	1	3832-152





Juego de 7 coronas Superior™



3833-SET-101

kg  2,75 kg   1 3833-SET-101



- 3833-19-C, 3833-22-C, 3833-29-C, 3833-35-C, 
- 3833-44-C, 3833-51-C, 3833-64-C
- 3834-ARBR-930EL, 3834-ARBR-9100EL 
- 3834-DRL-EL 

Juego de 10 coronas de sierra Superior™



3833-SET-202

kg  4,1 kg   1 3833-SET-202



- 3833-19-C, 3833-20-C, 3833-25-C, 3833-32-C, 
- 3833-41-C, 3833-51-C, 3833-57-C, 3833-60-C, 3833-73-C, 3833-83-C
- 3834-ARBR-930EL, 3834-ARBR-9100EL 
- 3834-DRL-EL 

Juego de 7 coronas de sierra Superior™



3833-SET-204

kg  3,88 kg   1 3833-SET-204



- 3833-32-C, 3833-41-C, 3833-51-C, 3833-73-C, 
- 3833-76-C, 3833-83-C, 3833-86-C
- 3834-ARBR-9100EL 
- 3834-DRL-EL 

Juego de 10 coronas de sierra Superior™



3833-SET-201

kg  4,35 kg   1 3833-SET-201



- 3833-19-C, 3833-20-C, 3833-25-C, 3833-32-C, 
- 3833-41-C, 3833-51-C, 3833-73-C, 3833-76-C, 3833-83-C, 3833-86-C
- 3834-ARBR-930EL, 3834-ARBR-9100EL 
- 3834-DRL-EL 

Juego de 10 coronas de sierra Superior™



3833-SET-203

kg  4,65 kg   1 3833-SET-203



- 3833-19-C, 3833-22-C, 3833-54-C, 3833-56-C, 
- 3833-57-C, 3833-62-C, 3833-68-C, 3833-71-C, 3833-74-C, 3833-78-C
- 3834-ARBR-930EL, 3834-ARBR-9100EL 
- 3834-DRL-EL 

Juego de 5 coronas de sierra Superior™



3833-SET-205

kg  2,81 kg   1 3833-SET-205

- 3833-22-C, 3833-35-C, 3833-44-C, 3833-51-C, 
- 3833-67-C
- 3834-ARBR-930EL, 3834-ARBR-9100EL 
- 3834-DRL-EL 

Juego de 10 coronas de sierra Superior™



3833-SET-207

kg



3.90 kg

1 3833-SET-207

3833-19-C, 3833-22-C, 3833-25-C, 3833-35-C,
3833-44-C, 3833-51-C, 3833-64-C, 3833-67-C,
3833-76-C, 3833-83-C

3834-ARBR-930EL, 3834-ARBR-9100EL

3834-DRL-EL

Juego de 8 coronas de sierra Superior™



3833-SET-301

kg



4,38 kg

1 3833-SET-301

3833-25-C, 3833-32-C, 3833-35-C, 3833-51-C,
3833-54-C, 3833-76-C, 3833-92-C, 3833-114-C

3834-ARBR-930EL, 3834-ARBR-9100EL

3834-DRL-EL

Juego de 8 coronas de sierra Superior™



3833-SET-303

kg



4,17 kg

1 3833-SET-303

3833-35-C, 3833-40-C, 3833-51-C, 3833-57-C,
3833-60-C, 3833-74-C, 3833-83-C, 3833-105-C

3834-ARBR-9100EL

3834-DRL-EL

Juego de 11 coronas de sierra Superior™



3833-SET-208

kg



3.72 kg

1 3833-SET-208

3833-19-C, 3833-22-C, 3833-25-C, 3833-32-C,
3833-35-C, 3833-38-C, 3833-44-C, 3833-51-C,
3833-57-C, 3833-68-C, 3833-76-C

3834-ARBR-930EL, 3834-ARBR-9100EL

3834-DRL-EL

Juego de 4 coronas de sierra Superior™



3833-SET-302

kg



3,51 kg

1 3833-SET-302

3833-51-C, 3833-76-C, 3833-86-C, 3833-111-C

3834-ARBR-9100EL

3834-DRL-EL

Juego de 9 coronas de sierra Superior™



3833-SET-304

kg



4,20 kg

1 3833-SET-304

3833-19-C, 3833-25-C, 3833-32-C, 3833-35-C,
3833-51-C, 3833-54-C, 3833-76-C, 3833-92-C,
3833-114-C

3834-ARBR-930EL, 3834-ARBR-9100EL

3834-DRL-EL



Corona multiconstrucción, madera y ladrillo



3833

19	1	3833-19-C	
20	1	3833-20-C	
22	1	3833-22-C	
25	1	3833-25-C	
27	1	3833-27-C	
29	1	3833-29-C	
30	1	3833-30-C	
32	1	3833-32-C	
35	1	3833-35-C	
38	1	3833-38-C	
40	1	3833-40-C	
41	1	3833-41-C	
44	1	3833-44-C	
48	1	3833-48-C	
51	1	3833-51-C	
54	1	3833-54-C	
56	1	3833-56-C	
57	1	3833-57-C	
60	1	3833-60-C	
62	1	3833-62-C	
64	1	3833-64-C	
65	1	3833-65-C	
67	1	3833-67-C	
68	1	3833-68-C	
70	1	3833-70-C	
71	1	3833-71-C	
73	1	3833-73-C	
74	1	3833-74-C	
76	1	3833-76-C	
77	1	3833-77-C	
78	1	3833-78-C	
79	1	3833-79-C	
83	1	3833-83-C	
86	1	3833-86-C	
89	1	3833-89-C	
92	1	3833-92-C	
95	1	3833-95-C	
98	1	3833-98-C	
102	1	3833-102-C	
105	1	3833-105-C	
108	1	3833-108-C	
109	1	3833-109-C	
111	1	3833-111-C	
114	1	3833-114-C	
121	1	3833-121-C	
127	1	3833-127-C	
133	1	3833-133-C	
140	1	3833-140-C	
152	1	3833-152-C	
159	1	3833-159-C	
168	1	3833-168	
177	1	3833-177	
210	1	3833-210	
225	1	3833-225	

Soporte para coronas con función eyectora



3834-ARBR-EL/ES

19-30	8.5	1	3834-ARBR-930EL
32-159	8.5	1	3834-ARBR-9100EL
16-30 mm	8.5 mm	1	3834-ARBR-930ESM
32-152 mm	8.5 mm	1	3834-ARBR-9100ESM

ES: Bimetal y metal duro (Diam. 14-30/Diam 32-210mm)

EL: Metal duro (Diam19-30/Diam 32-159)

Soporte de corona



3834-ARBR

14-30	6.4	1	3834-ARBR-630
14-30	6.4	1	3834-ARBR-630-C
14-30	6.4 TRI	1	3834-ARBR-730
14-30	6.4 TRI	1	3834-ARBR-730-C
14-30	8.5	1	3834-ARBR-930
14-30	8.5	1	3834-ARBR-930-C
14-30	11.1	4	3834-ARBR-1130
14-30	11.1	1	3834-ARBR-1130-C

Soporte para coronas, cambio rápido



3834-ARBR-QC

32-100	8.5	1	3834-ARBR-9100
32-100	8.5	1	3834-ARBR-9100-C
32-100	8.5	1	3834-ARBR-9100QC
32-100	8.5	1	3834-ARBR-9100QC-C
32-210	11.1	1	3834-ARBR-11152

32-210	11.1	1	3834-ARBR-11152-C
32-210	11.1	1	3834-ARBR-11152QC
32-210	11.1	1	3834-ARBR-11152QC-C
32-210	15.4	1	3834-ARBR-16152
32-210	15.4	1	3834-ARBR-16152QC

Soporte de corona
Para máquinas de cambio rápido



3834-ARBR-SD

14-30	SDS+ mm	1	3834-ARBR-SD30
32-210	SDS+ mm	1	3834-ARBR-SD152QC

Accesorios de coronas, broca piloto con eyector corto



3834-DRL-HSS-ES

6.35 mm	138	1	3834-DRL-ES
6.35 mm	138	1	3834-DRL-HSS-ES

Broca piloto con punta de carburo para soportes
930EL y 9100EL



3834-DRL-EL

6.35 mm	202	1	3834-DRL-EL

para soportes 930EL y 9100EL

Broca piloto



3834-DRL

6.35 mm	81	1	3834-DRL

Accesorios para coronas de sierra, broca piloto de carburo STD



3834-DRL-CT/L

6.35 mm	81	1	3834-DRL-CT
6.35 mm	114	1	3834-DRL-L

Tornillos de repuesto para soportes de corona



3834-SCREWS

9	1	3834-M6X29-SET
9	1	3834-M8X5-SET
9	1	3834-M8X6-SET
9	1	3834-M8X10-SET

Aumentador para agujeros



3834-upsize

20.5	1	3834-UPSIZE

Muelle expulsor



3834-ES

10	1	3834-ES

Adaptador para soporte



3834-ADP

20	1	3834-ADP

Prolongador



3834-EXT

11.1	330	1	3834-EXT-1
8.5	330	1	3834-EXT-2

HOJAS DE SABLE

Juego de 5 hojas de sierra, para metal



3940-METAL-SET-5P

5	125	5	3940-METAL-SET-5P

Juego de 5 hojas de sable, metal duro y demolición



3940-HDD-SET-5P

5	222	5	3940-HDD-SET-5P



Juego de hojas de sable, para metal y madera



3940-MIX-SET-5P

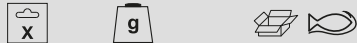

5 150 5 3940-MIX-SET-5P

Juego de 10 hojas de sierra, para metal y madera



3940-MIX-SET-10P

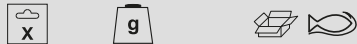

10 245 4 3940-MIX-SET-10P

Juego de 5 hojas de sable, para madera



3942-WOOD-SET-5P



5 191 5 3942-WOOD-SET-5P

Hoja de sierra para talleres de automoción
Sandflex® Bi-metal



3845

Length	Teeth	Material	Product
91.5	18	1	3845-18-10P
91.5	24	1	3845-24-10P
90	32	1	3845-32-10P

Hojas de sable con punta de carburo para materiales de piedra



3946-CT

Length	Teeth	Material	Product
150	6	5	3946-150-6-SL-1P
228	3	5	3946-228-3-ST-1P
300	3	5	3946-300-3-ST-1P
300	6	5	3946-300-6-ST-1P

Hoja de sable de grano de carburo para azulejos y vidrio



3946-CG

Length	Teeth	Material	Product
100	Grit	5	3946-100-G-ST-2P
150	Grit	5	3946-150-G-ST-2P

Hoja de acero inoxidable para corte de carne y hielo



3944

Length	Teeth	Material	Product
300	3	5	3944-300-3-MEAT-1P

Hoja de sable, para madera HCS



3942-W

Length	Teeth	Material	Product
228	7	5	3942-228-7-HSL-2P
228	7	5	3942-228-7-HSL-5P
228	7	1	3942-228-7-HSL-10P
300	7	5	3942-300-7-HSL-2P
300	7	5	3942-300-7-HSL-5P
300	7	1	3942-300-7-HSL-10P

Hoja de sable HCS para madera gruesa



3942-CW

Length	Teeth	Material	Product
228	5	5	3942-228-5-HSL-2P
228	5	5	3942-228-5-HSL-5P
228	5	1	3942-228-5-HSL-10P
300	5	5	3942-300-5-HSL-2P
300	5	5	3942-300-5-HSL-5P
300	5	1	3942-300-5-HSL-10P

Hojas de sable HSC para madera y plástico



3942-WP

Length	Teeth	Material	Product
228	11	5	3942-228-11-HSL-2P
228	11	5	3942-228-11-HSL-5P
228	11	1	3942-228-11-HSL-10P

Hoja de sable bi-metal, para yeso y planchas



3942-PB

Length	Teeth	Material	Product
150	7	5	3942-150-7-SL-2P
150	7	5	3942-150-7-SL-5P

150	7	1	3942-150-7-SL-10P
228	7	5	3942-228-7-SL-2P
228	7	5	3942-228-7-SL-5P
228	7	1	3942-228-7-SL-10P
300	7	5	3942-300-7-SL-2P
300	7	5	3942-300-7-SL-5P
300	7	1	3942-300-7-SL-10P

Hoja de sable bi-metal



3940-M

100	14	5	3940-100-14-ST-2P
100	14	5	3940-100-14-ST-5P
100	14	1	3940-100-14-ST-10P
100	18	5	3940-100-18-ST-2P
100	18	5	3940-100-18-ST-5P
100	18	1	3940-100-18-ST-10P
150	14	5	3940-150-14-ST-2P
150	14	5	3940-150-14-ST-5P
150	14	1	3940-150-14-ST-10P
150	14	1	3940-150-14-ST-100P
150	18	5	3940-150-18-ST-2P
150	18	5	3940-150-18-ST-5P
150	18	1	3940-150-18-ST-10P
150	18	1	3940-150-18-ST-100P
228	14	5	3940-228-14-ST-2P
228	14	5	3940-228-14-ST-5P
228	14	1	3940-228-14-ST-10P
228	14	1	3940-228-14-ST-100P
228	18	5	3940-228-18-ST-2P
228	18	5	3940-228-18-ST-5P
228	18	1	3940-228-18-ST-10P
228	18	1	3940-228-18-ST-100P
300	14	5	3940-300-14-ST-2P
300	14	5	3940-300-14-ST-5P
300	14	1	3940-300-14-ST-10P
300	14	1	3940-300-14-ST-100P
300	18	5	3940-300-18-ST-2P
300	18	5	3940-300-18-ST-5P
300	18	1	3940-300-18-ST-10P
300	18	1	3940-300-18-ST-100P

Hoja de sable para metal duro



3940-HM

150	10	5	3940-150-10-HST-2P
150	10	5	3940-150-10-HST-5P

150	10	1	3940-150-10-HST-10P
150	10	1	3940-150-10-ST-100P
150	10	5	3940-150-10-ST-2P
150	10	5	3940-150-10-ST-5P
150	10	1	3940-150-10-ST-10P
150	14	5	3940-150-14-HST-2P
150	14	5	3940-150-14-HST-5P
150	14	1	3940-150-14-HST-10P
150	18	5	3940-150-18-HST-2P
150	18	5	3940-150-18-HST-5P
150	18	1	3940-150-18-HST-10P
150	8/12	5	3940-150-8/12-ST-2P
150	8/12	5	3940-150-8/12-ST-5P
150	8/12	1	3940-150-8/12-ST-10P
150	8/12	1	3940-150-8/12-ST-100P
228	10	5	3940-228-10-HST-2P
228	10	5	3940-228-10-HST-5P
228	10	1	3940-228-10-HST-10P
228	10	5	3940-228-10-ST-2P
228	10	5	3940-228-10-ST-5P
228	10	1	3940-228-10-ST-10P
228	10	1	3940-228-10-ST-100P
228	14	5	3940-228-14-HST-2P
228	14	5	3940-228-14-HST-5P
228	14	1	3940-228-14-HST-10P
228	18	5	3940-228-18-HST-2P
228	18	5	3940-228-18-HST-5P
228	18	1	3940-228-18-HST-10P
228	8/12	5	3940-228-8/12-ST-2P
228	8/12	5	3940-228-8/12-ST-5P
228	8/12	1	3940-228-8/12-ST-10P
228	8/12	1	3940-228-8/12-ST-100P
300	10	5	3940-300-10-HST-2P
300	10	5	3940-300-10-HST-5P
300	10	1	3940-300-10-HST-10P
300	14	5	3940-300-14-HST-2P
300	14	5	3940-300-14-HST-5P
300	14	1	3940-300-14-HST-10P
300	18	5	3940-300-18-HST-2P
300	18	5	3940-300-18-HST-5P
300	18	1	3940-300-18-HST-10P

Hojas de sable para metal fino



3940-FM

100	24	5	3940-100-24-ST-2P
100	24	5	3940-100-24-ST-5P
100	24	1	3940-100-24-ST-10P
150	24	5	3940-150-24-ST-2P
150	24	5	3940-150-24-ST-5P
150	24	1	3940-150-24-ST-10P
150	24	1	3940-150-24-ST-100P

Hoja de sable bi-metal de precisión



3940-PM

100	14	5	3940-100-14-SC-2P
100	14	5	3940-100-14-SC-5P
100	18	5	3940-100-18-SC-2P
100	18	5	3940-100-18-SC-5P
100	24	5	3940-100-24-SC-2P
100	24	5	3940-100-24-SC-5P

Hoja de sierra bi-metal, para madera y metal



3940-WM

150	4/6	5	3940-150-4/6-SC-2P
150	4/6	5	3940-150-4/6-SC-5P
150	4/6	1	3940-150-4/6-SC-10P
150	5/8	2	3940-150-5/8-SL-2P
150	5/8	5	3940-150-5/8-SL-5P
150	5/8	1	3940-150-5/8-SL-10P
150	5/8	1	3940-150-5/8-SL-100P
150	6	5	3940-150-6-ST-2P
150	6	5	3940-150-6-ST-5P
150	6	1	3940-150-6-ST-10P
228	6	5	3940-228-6-SL-2P
228	6	5	3940-228-6-SL-5P
228	6	1	3940-228-6-SL-10P
300	6	5	3940-300-6-SL-2P
300	6	5	3940-300-6-SL-5P
300	6	1	3940-300-6-SL-10P
300	8/12	5	3940-300-8/12-SL-2P
300	8/12	5	3940-300-8/12-SL-5P
300	8/12	1	3940-300-8/12-SL-10P
300	8/12	1	3940-300-8/12-SL-100P

Hoja de sable bi-metal, para "fuego y rescate"



3940-FR

228	10	5	3940-228-10-DSL-2P
228	10	5	3940-228-10-DSL-5P
228	10	1	3940-228-10-DSL-10P



Hoja de sable bi-metal para demolición



3940-D

Longitud	Perfil	Cant.	Modelo
150	5/8	5	3940-150-5/8-DSL-2P
150	5/8	5	3940-150-5/8-DSL-5P
150	5/8	1	3940-150-5/8-DSL-10P
228	5/8	5	3940-228-5/8-DSL-2P
228	5/8	5	3940-228-5/8-DSL-5P
228	5/8	1	3940-228-5/8-DSL-10P
300	5/8	5	3940-300-5/8-DSL-2P
300	5/8	5	3940-300-5/8-DSL-5P
300	5/8	1	3940-300-5/8-DSL-10P

Hoja de sable bi-metal, para reparación de pallets



3940-PR

Longitud	Perfil	Cant.	Modelo
228	10/14	1	3940-228-10/14-PR09-10P
228	10/14	1	3940-228-10/14-PR09-100P
228	10/14	1	3940-228-10/14-PR13-100P
228	8/12	1	3940-228-8/12-PR13-100P

HOJAS DE CALAR

Anclaje europeo, acero al carbono
Para metal



91-M

Longitud	Perfil	Cant.	Modelo
100	Prog	1	91-3PM-5P
100	8	1	91-433-5P
77	36	1	91-502-5P
77	24	1	91-512-5P
77	24	1	91-517-5P
77	14	1	91-522-5P
132	24	1	91-611-5P
77	24	1	91-612-5P
77	14	1	91-622-5P
132	10/14	1	91-7V1-5P

Anclaje europeo, acero al carbono Para madera y metal



91-WM

Longitud	Perfil	Cant.	Modelo
116	Prog	1	91-2PW-5P
132	Prog	1	91-4PWW-5P
116	10	1	91-623-5P

Anclaje europeo, acero al carbono
Para madera blanda



91-W

Longitud	Perfil	Cant.	Modelo
116	8	1	91-434-5P
152	6	1	91-444-5P
100	8	1	91-023-5P
77	12	1	91-027-5P
100	6	1	91-143-5P
100	6	1	91-148-5P
100	10	1	91-223-5P
100	10	1	91-226-5P
100	6	1	91-243-5P
76	20	1	91-412-5P
100	6	1	91-443-5P
116	8	1	91-233-5P

HOJAS PARA SIERRAS CIRCULARES

Sierra circular para aluminio y plástico



8501-AP

Diámetro	Perfil	Cant.	Modelo
125 mm	48	1	8501-17S
216 mm	48	1	8501-18S
250 mm	80	1	8501-28S
260 mm	80	1	8501-260-30-80S
300 mm	96	1	8501-30S
305 mm	96	1	8501-305-30-96S

Sierra circular para madera media



8501-P/T

Diámetro	Perfil	Cant.	Modelo
125 mm	16	1	8501-2
130 mm	16	1	8501-3
140 mm	16	1	8501-4
140 mm	24	1	8501-4F
140 mm	30	1	8501-4XF
150 mm	18	1	8501-5
150 mm	30	1	8501-5F
160 mm	18	1	8501-7
160 mm	30	1	8501-7F
170 mm	18	1	8501-10
170 mm	30	1	8501-10F
180 mm	20	1	8501-12
180 mm	40	1	8501-12F
184 mm	24	1	8501-13
184 mm	40	1	8501-13F
184 mm	24	1	8501-184-16-24
184 mm	40	1	8501-184-16-40
190 mm	20	1	8501-15
190 mm	40	1	8501-15F
190 mm	60	1	8501-190-30-60XF
200 mm	20	1	8501-16
200 mm	40	1	8501-16F
210 mm	20	1	8501-17
210 mm	40	1	8501-17F
210 mm	60	1	8501-210-30-60XF
230 mm	20	1	8501-22
230 mm	40	1	8501-22F
230 mm	60	1	8501-230-30-60XF
235 mm	30	1	8501-23
235 mm	40	1	8501-23F
235 mm	60	1	8501-235-30-60XF
250 mm	24	1	8501-28
250 mm	40	1	8501-28F
250 mm	60	1	8501-28XF

Sierra circular para madera



8501-S

Diámetro	Perfil	Cant.	Modelo
300 mm	30	1	8501-30
300 mm	40	1	8501-30F
300 mm	60	1	8501-30XF
315 mm	30	1	8501-31

			
315 mm	40	1	8501-31F
400 mm	40	1	8501-40

Sierra circular para madera







8501-P

			
160 mm	48	1	8501-160-20-48XF
165 mm	48	1	8501-165-20-48XF

Sierra circular para madera







8501-M

			
210 mm	48	1	8501-210-30-48SW
216 mm	24	1	8501-16SW
216 mm	48	1	8501-18SW
216 mm	60	1	8501-216-60SW
250 mm	60	1	8501-28SW
260 mm	24	1	8501-260-24SW
260 mm	40	1	8501-260-40SW
260 mm	60	1	8501-260-60SW
300 mm	60	1	8501-30SW
305 mm	40	1	8501-305-30-40SW
305 mm	60	1	8501-305-30-60SW

Sierra circular para madera media



8501-C





			
136 mm	24	1	8501-136-10-24C
136 mm	24	1	8501-136-20-24C
150 mm	24	1	8501-150-10-24C
160 mm	24	1	8501-160-20-24C
165 mm	24	1	8501-165-20-24C
184 mm	24	1	8501-184-20-24C
190 mm	24	1	8501-190-30-24C

SIERRAS DE CINTA

Hojas de sierra



3857 Easy-Cut Portaband



			
M	EZ	1	3857-13-0.6-EZ-M-3P690
M	EZ	1	3857-13-0.6-EZ-M-3P730
M	EZ	1	3857-13-0.6-EZ-M-3P835
M	EZ	1	3857-13-0.6-EZ-M-3P900
M	EZ	1	3857-13-0.6-EZ-M-3P1140

LIMAS ROTATIVAS

Limas rotativas de Carburo de Tungsteno
Limas para aluminio, cilíndricas





A-AL

			
6 mm	AL	1	A0616AL06E
12 mm	AL	1	A1225AL06E
12 mm	AL	1	A1225AL08E

Limas rotativas de Carburo de Tungsteno
Limas para aluminio, cilíndricas punta redonda



C-AL

			
6 mm	AL	1	C0616AL06
12 mm	AL	1	C1225AL06
12 mm	AL	1	C1225AL08

Limas rotativas de Carburo de Tungsteno
Limas para aluminio, esféricas



D-AL

			
12 mm	AL	1	D1211AL06
12 mm	AL*	1	D1211AL08



Limas rotativas de Carburo de Tungsteno
Limas para aluminio, ojivales punta redonda



F-AL

Ø	Material	Grain	Flute	Tip	Code
6 mm	AL				F0618AL06
12 mm	AL				F1225AL06
12 mm	AL				F1225AL08

Limas rotativas de Carburo de Tungsteno
Limas para aluminio, cónicas punta redondeada



L-AL

Ø	Material	Grain	Flute	Tip	Code
12 mm	AL				L1230AL06
12 mm	AL*				L1230AL08

Limas rotativas de Carburo de Tungsteno, cilíndrica
F=fino, M=medio, C=grueso



A

Ø	Material	Grain	Flute	Tip	Code
3 mm	C				A0313C03
3 mm	F				A0313F03
3 mm	F*				A0313F03E
3 mm	M				A0313M03
3 mm	M*				A0313M03E
3 mm	M				A0313M03X
3 mm	M XE				A0313M03XE
3 mm	M*				A0313M03XE-60
3 mm	M				A0313M03XE-80
6 mm	M X				A0613M03X
6 mm	C				A0616C06
6 mm	F				A0616F06
6 mm	M				A0616M06
6 mm	M*				A0616M06DE
6 mm	M				A0616M06E
6 mm	M				A0616M06X
6 mm	M				A0616M06XE
8 mm	F				A0820F06

Ø	Material	Grain	Flute	Tip	Code
8 mm	F*				A0820F06E
8 mm	M				A0820M06
8 mm	M*				A0820M06E
8 mm	M				A0820M06X
8 mm	M				A0820M06XE
8 mm	C*				A0820C06
10 mm	F*				A1020F06
10 mm	M				A1020M06
10 mm	M*				A1020M06E
10 mm	M				A1020M06X
10 mm	M				A1020M06XE
10 mm	C*				A1020C06
10 mm	x				A1040M06X
10 mm	x*				A1050M06X
12 mm	F*				A1225F06
12 mm	F*				A1225F06E
12 mm	M				A1225M06
12 mm	M*				A1225M06DE
12 mm	M*				A1225M06E
12 mm	M				A1225M06X
12 mm	M				A1225M06XE
12 mm	C				A1225C06
12 mm	F*				A1225F08
12 mm	M				A1225M08
12 mm	M*				A1225M08E
12 mm	M*				A1225M08X
12 mm	M*				A1225M08XE
12 mm	C*				A1225C08
16 mm	F*				A1625F06
16 mm	M*				A1625M06
16 mm	M				A1625M06X
16 mm	M*				A1625M06XE
16 mm	C*				A1625C06
16 mm	F*				A1625F08
16 mm	M				A1625M08
16 mm	M*				A1625M08E
16 mm	M				A1625M08X
16 mm	M				A1625M08XE
16 mm	C*				A1625C08

F=Fino, M=Entrefino, C=Basto, EC= Extra Basto

Limas rotativas de Carburo de Tungsteno, Cilíndrica
punta redonda
F=fino, M=medio, C=grueso



C

Ø	Material	Grain	Flute	Tip	Code
3 mm	C				C0313C03
3 mm	F				C0313F03
3 mm	M				C0313M03
3 mm	M				C0313M03X
6 mm	M				C0613M03X
6 mm	C				C0616C06
6 mm	F				C0616F06
6 mm	M				C0616M03X
6 mm	M				C0616M06
6 mm	M*				C0616M06D
6 mm	M				C0616M06X
8 mm	F				C0820F06
8 mm	M				C0820M06
8 mm	M				C0820M06X
8 mm	C*				C0820C06

Ø	Material	Grain	Flute	Tip	Code
10 mm	F*				C1020F06
10 mm	M				C1020M06
10 mm	M				C1020M06X
10 mm	C				C1020C06
12 mm	F				C1225F06
12 mm	M				C1225M06
12 mm	M				C1225M06X
12 mm	C				C1225C06
12 mm	F*				C1225F08
12 mm	M				C1225M08
12 mm	M				C1225M08X
12 mm	C*				C1225C08
16 mm	F*				C1625F06
16 mm	M				C1625M06
16 mm	M				C1625M06X
16 mm	C*				C1625C06
16 mm	F*				C1625F08
16 mm	M				C1625M08
16 mm	M				C1625M08X
16 mm	C*				C1625C08

F=Fino, M=Entrefino, C=Basto, EC= Extra Basto

Limas rotativas de Carburo de Tungsteno
Esférica



D

Ø	Material	Grain	Flute	Tip	Code
3 mm	F				D0303F03
3 mm	M				D0303M03
3 mm	M				D0303M03X
3 mm	C*				D0303C03
6 mm	M				D0605M03X
6 mm	F*				D0606F06
6 mm	M				D0606M06
6 mm	M				D0606M06X
6 mm	C				D0606C06
8 mm	F*				D0807F06
8 mm	M				D0807M06
8 mm	M				D0807M06X
8 mm	C*				D0807C06
10 mm	F*				D1009F06
10 mm	M				D1009M06
10 mm	M				D1009M06X
10 mm	C				D1009C06
12 mm	F				D1211F06
12 mm	D*				D1211F06D
12 mm	M				D1211M06
12 mm	M				D1211M06X
12 mm	C				D1211C06
16 mm	F*				D1614F06
16 mm	M				D1614M06
16 mm	M				D1614M06X
16 mm	C*				D1614C06
16 mm	F*				D1614F08
16 mm	M*				D1614M08
16 mm	M*				D1614M08X
16 mm	C*				D1614C08

F=Fino, M=Entrefino, C=Basto, EC= Extra Basto

Limas rotativas de Carburo de Tungsteno, ovalada
F=fino, M=medio, C=grueso



E

3 mm	F*		1	E0308F03
3 mm	M		1	E0308M03
3 mm	M*		1	E0308M03X
3 mm	C*		1	E0308C03
6 mm	F*		1	E0614F06
6 mm	M		1	E0614M06
6 mm	C*		1	E0614C06
8 mm	F*		1	E0816F06
8 mm	M		1	E0816M06
8 mm	M		1	E0816M06X
8 mm	C*		1	E0816C06
10 mm	F*		1	E1018F06
10 mm	M		1	E1018M06
10 mm	M		1	E1018M06X
10 mm	C*		1	E1018C06
12 mm	F*		1	E1222F06
12 mm	M		1	E1222M06
12 mm	M		1	E1222M06X
12 mm	C*		1	E1222C06
12 mm	F*		1	E1222F08
12 mm	M*		1	E1222M08
12 mm	M*		1	E1222M08X
12 mm	C*		1	E1222C08
16 mm	F*		1	E1625F06
16 mm	M		1	E1625M06
16 mm	M		1	E1625M06X
16 mm	C*		1	E1625C06
16 mm	F*		1	E1625F08
16 mm	M*		1	E1625M08
16 mm	M		1	E1625M08X
16 mm	C*		1	E1625C08

F=Fin, M=Entrefino, C=Basto, EC=Extra Basto

Limas rotativas de Carburo de Tungsteno, Ojival punta redonda. F=fino, M=medio, C=grueso, * se fabrica bajo demanda



F

3 mm	F		1	F0313F03
3 mm	M		1	F0313M03
3 mm	M		1	F0313M03X
3 mm	C*		1	F0313C03
6 mm	F*		1	F0612F04
6 mm	M*		1	F0612M04
6 mm	M*		1	F0612M04X
6 mm	C*		1	F0612C04
6 mm	M		1	F0613M03X
6 mm	F*		1	F0618F06
6 mm	M		1	F0618M06

6 mm	M		1	F0618M06X
6 mm	C		1	F0618C06
8 mm	F*		1	F0820F06
8 mm	M		1	F0820M06
8 mm	M		1	F0820M06X
8 mm	C*		1	F0820C06
10 mm	F*		1	F1020F06
10 mm	M		1	F1020M06
10 mm	M		1	F1020M06X
10 mm	C*		1	F1020C06
12 mm	F		1	F1225F06
12 mm	M		1	F1225M06
12 mm	M		1	F1225M06X
12 mm	C		1	F1225C06
12 mm	F*		1	F1225F08
12 mm	M		1	F1225M08
12 mm	M		1	F1225M08X
12 mm	C*		1	F1225C08
16 mm	F*		1	F1625F06
16 mm	M		1	F1625M06
16 mm	M		1	F1625M06X
16 mm	C*		1	F1625C06
16 mm	F*		1	F1625F08
16 mm	M*		1	F1625M08
16 mm	M*		1	F1625M08X
16 mm	C*		1	F1625C08

F=Fin, M=Entrefino, C=Basto, EC= Extra Basto

Limas rotativas de Carburo de Tungsteno
Ojival con punta



G

3 mm	F		1	G0313F03
3 mm	M		1	G0313M03
3 mm	M		1	G0313M03X
3 mm	C		1	G0313C03
6 mm	M		1	G0613M03X
6 mm	F		1	G0618F06
6 mm	M		1	G0618M06
6 mm	M		1	G0618M06X
6 mm	C		1	G0618C06
8 mm	F*		1	G0820F06
8 mm	M		1	G0820M06
8 mm	M		1	G0820M06X
8 mm	C*		1	G0820C06
10 mm	F*		1	G1020F06
10 mm	M		1	G1020M06
10 mm	M		1	G1020M06X
10 mm	C*		1	G1020C06
12 mm	F		1	G1225F06
12 mm	M		1	G1225M06
12 mm	M		1	G1225M06X
12 mm	C		1	G1225C06
12 mm	F*		1	G1225F08
12 mm	M		1	G1225M08
12 mm	M		1	G1225M08X
12 mm	C*		1	G1225C08
16 mm	F*		1	G1625F06
16 mm	M		1	G1625M06
16 mm	M		1	G1625M06X
16 mm	C*		1	G1625C06

16 mm	F*		1	G1625F08
16 mm	M*		1	G1625M08
16 mm	M		1	G1625M08X
16 mm	C*		1	G1625C08

F=Fin, M=Entrefino, C=Basto, EC= Extra Basto *Fabricación bajo pedido

Limas rotativas de Carburo de Tungsteno
Forma de llama



H

6 mm	M		1	H0613M03X
10 mm	F*		1	H1025F06
10 mm	M		1	H1025M06
10 mm	M*		1	H1025M08
10 mm	M		1	H1025M06X
10 mm	C*		1	H1025C06
12 mm	M		1	H1232M06
12 mm	M		1	H1232M06X
16 mm	F*		1	H1635F06
16 mm	M		1	H1635M06X
16 mm	M*		1	H1635M06
16 mm	C*		1	H1635C06
16 mm	F*		1	H1635F08
16 mm	M*		1	H1635M08
16 mm	M*		1	H1635M08X
16 mm	C*		1	H1635C08

F=Fin, M=Entrefino, C=Basto, EC= Extra Basto

Limas rotativas de Carburo de Tungsteno, Cónica 60°
F=fino, M=medio, C=grueso, * se fabrica bajo demanda



J

6 mm	F*		1	J0604F06
6 mm	M		1	J0604M06
6 mm	C*		1	J0604C06
10 mm	F*		1	J1010F06
10 mm	M		1	J1010M06
10 mm	C*		1	J1010C06
12 mm	M		1	J1212M06
16 mm	F*		1	J1616F06
16 mm	M		1	J1616M06
16 mm	C*		1	J1616C06
16 mm	F*		1	J1616F08
16 mm	M*		1	J1616M08
16 mm	C*		1	J1616C08

F=Fin, M=Entrefino, C=Basto, EC= Extra Basto *Fabricación bajo pedido



Limas rotativas de Carburo de Tungsteno, Cónica 90°
F=fino, M=medio, C=grueso, * se fabrica bajo demanda



K

6 mm	F*		1	K0602F06
6 mm	M		1	K0602M06
6 mm	C*		1	K0602C06
10 mm	F*		1	K1008F06
10 mm	M		1	K1008M06
10 mm	C*		1	K1008C06
12 mm	F*		1	K1210F06
12 mm	M		1	K1210M06
12 mm	C*		1	K1210C06
16 mm	F*		1	K1612F06
16 mm	M*		1	K1612M06
16 mm	C*		1	K1612C06
16 mm	M		1	K1612M08
16 mm	F*		1	K1612F08
16 mm	C*		1	K1612C08

F=Fino, M=Entrefino, C=Basto, EC= Extra Basto

Limas rotativas de Carburo de Tungsteno, Cónica punta redonda. F=fino, M=medio, C=grueso, * se fabrica bajo demanda



L

10 mm	F*		1	L1020F06
10 mm	M		1	L1020M06
10 mm	M		1	L1020M06X
10 mm	C*		1	L1020C06
12 mm	F*		1	L1225F06
12 mm	M		1	L1225M06
12 mm	M		1	L1225M06X
12 mm	F*		1	L1230F06
12 mm	M		1	L1230M06
12 mm	M		1	L1230M06X
12 mm	C*		1	L1230C06
16 mm	F*		1	L1630F06
16 mm	M*		1	L1630M06
16 mm	M		1	L1630M06X
16 mm	C*		1	L1630C06
16 mm	M		1	L1630M08
16 mm	M		1	L1630M08X
16 mm	F*		1	L1630F08
16 mm	C*		1	L1630C08

F=Fino, M=Entrefino, C=Basto, EC= Extra Basto

Limas rotativas de Carburo de Tungsteno, Cónica con punta
F=fino, M=medio, C=grueso



M

3 mm	F		1	M0310F03
3 mm	M		1	M0310M03
3 mm	M		1	M0310M03X
3 mm	C*		1	M0310C03
6 mm	M		1	M0613M03X
6 mm	F		1	M0618F06
6 mm	M		1	M0618M06
6 mm	M		1	M0618M06X
6 mm	C		1	M0618C06
10 mm	F*		1	M1022F06
10 mm	M		1	M1022M06
10 mm	M*		1	M1022M06D
10 mm	M		1	M1022M06X
10 mm	C*		1	M1022C06
12 mm	F*		1	M1227F06
12 mm	M		1	M1227M06
12 mm	M		1	M1227M06X
12 mm	C*		1	M1227C06
12 mm	F*		1	M1227F08
12 mm	M*		1	M1227M08
12 mm	M*		1	M1227M08X
12 mm	C*		1	M1227C08
16 mm	F*		1	M1630F06
16 mm	M		1	M1630M06
16 mm	M		1	M1630M06X
16 mm	C*		1	M1630C06
16 mm	F*		1	M1630F08
16 mm	M		1	M1630M08
16 mm	M		1	M1630M08X
16 mm	C*		1	M1630C08

F=Fino, M=Entrefino, C=Basto, EC=Extra Basto

Limas rotativas de Carburo de Tungsteno, Cónica invertida. F=fino, M=medio, C=grueso, * se fabrica bajo demanda



N

3 mm	F*		1	N0306F03
3 mm	M		1	N0306M03
3 mm	M*		1	N0306M03E
3 mm	C*		1	N0306C03
6 mm	F*		1	N0607F06

6 mm	M*		1	N0607M06
6 mm	M*		1	N0607M06E
6 mm	C*		1	N0607C06
12 mm	F*		1	N1213F06
12 mm	M		1	N1213M06
12 mm	M*		1	N1213M06E
12 mm	x		1	N1213M06X
12 mm	C*		1	N1213C06
16 mm	F*		1	N1613F06
16 mm	M*		1	N1613M06
16 mm	M*		1	N1613M06E
16 mm	M*		1	N1613M06X
16 mm	C*		1	N1613C06
16 mm	F*		1	N1613F08
16 mm	M		1	N1613M08
16 mm	M*		1	N1613M08E
16 mm	C		1	N1613C08

F=Fino, M=Entrefino, C=Basto, EC= Extra Basto

Lima rotativa de Carburo de Tungsteno
Limas especial para limado interior



A-int

4 mm	D*		1	A0408F03D
6 mm	D*		1	A0610F06D
8 mm	D		1	A0810F06D

Limas rotativas de Carburo de Tungsteno
Lima especial para reparación de llantas de neumáticos



A/G

3 mm	x		1	A0320M03X
6 mm	x		1	A0625M06X
6 mm	x*		1	G0645M4.9X
8 mm	x*		1	G0845M6.6X
10 mm	x*		1	G1050M8.3X
6 mm	x*		1	HSSG-G0645MX

Limas rotativas de acero rápido HSS, Cilíndrica
F=fino, M=medio, C=grueso



HSSG-A

Ø	Flute	Flute	Flute
6 mm	M	1	HSSG-A0616M
10 mm	M	1	HSSG-A1020M
12 mm	EC	1	HSSG-A1225EC
12 mm	M	1	HSSG-A1225M

F=Fino, M=Entrefino, C=Basto, EC= Extra Basto

Limas rotativas de acero rápido HSS, Cilíndrica
embalaje individual, Forma-A
F=fino, M=medio, C=grueso, EC=extra grueso



HSSG-A-S

Ø	Flute	Flute	Flute
6 mm	M	1	HSSG-A0616M-S
10 mm	M	1	HSSG-A1020M-S
12 mm	M	1	HSSG-A1225M-S
12 mm	EC	1	HSSG-A1225EC-S

F=Fino, M=Entrefino, C=Basto, EC= Extra Basto

Limas rotativas de acero rápido HSS, Cilíndrica punta
redondeada
M=medio, C=grueso, EC=extra grueso



HSSG-C

Ø	Flute	Flute	Flute
6 mm	M	1	HSSG-C0616M
10 mm	M	1	HSSG-C1020M
12 mm	EC	1	HSSG-C1225EC
12 mm	M	1	HSSG-C1225M

F=Fino, M=Entrefino, C=Basto, EC= Extra Basto

Limas rotativas de acero rápido HSS, Cilíndrica punta
redonda, embalaje individual
M=medio, C=grueso, EC=extra grueso



HSSG-C-S

Ø	Flute	Flute	Flute
6 mm	M	1	HSSG-C0616M-S
10 mm	M	1	HSSG-C1020M-S
12 mm	M	1	HSSG-C1225M-S
12 mm	EC	1	HSSG-C1225EC-S

F=Fino, M=Entrefino, C=Basto, EC= Extra Basto

Limas rotativas de acero rápido HSS, esférica
M=medio, C=grueso, EC=extra grueso



HSSG-D

Ø	Flute	Flute	Flute
6 mm	M	1	HSSG-D0606M
8 mm	M	1	HSSG-D0807M
10 mm	M	1	HSSG-D1009M
12 mm	EC	1	HSSG-D1211EC
12 mm	M	1	HSSG-D1211M

F=Fino, M=Entrefino, C=Basto, EC= Extra Basto

Limas de acero rápido HSS, Esférica, embalaje
individual
M=medio, C=grueso, EC=extra grueso



HSSG-D-S

Ø	Flute	Flute	Flute
6 mm	M	1	HSSG-D0606M-S
8 mm	M	1	HSSG-D0807M-S
10 mm	M	1	HSSG-D1009M-S
12 mm	M	1	HSSG-D1211M-S
12 mm	EC	1	HSSG-D1211EC-S

F=Fino, M=Entrefino, C=Basto, EC= Extra Basto

Limas rotativas de acero rápido, ovaladas
M=medio, C=grueso, EC=extra grueso



HSSG-E

Ø	Flute	Flute	Flute
6 mm	M	1	HSSG-E0614M
12 mm	EC	1	HSSG-E1222EC
12 mm	M	1	HSSG-E1222M

F=Fino, M=Entrefino, C=Basto, EC= Extra Basto

Limas de acero rápido HSS, Ovalada, embalaje
individual
M=medio, C=grueso, EC=extra grueso



HSSG-E-S

Ø	Flute	Flute	Flute
12 mm	M	1	HSSG-E1222M-S
12 mm	EC	1	HSSG-E1222EC-S

F=Fino, M=Entrefino, C=Basto, EC= Extra Basto

Limas rotativas de acero rápido HSS, ojal punta
redondeada
M=medio, C=grueso, EC=extra grueso



HSSG-F

Ø	Flute	Flute	Flute
6 mm	M	1	HSSG-F0618M
12 mm	M	1	HSSG-F1225M

F=Fino, M=Entrefino, C=Basto, EC= Extra Basto



Limas rotativas de acero rápido HSS, Ojival punta redonda, embalaje individual
M=medio, C=grueso, EC=extra grueso



HSSG-F-S

Ø	Wavy	Box	Icon
6 mm	M	1	HSSG-F0618M-S
12 mm	M	1	HSSG-F1225M-S

F=Fino, M=Entrefino, C=Basto, EC= Extra Basto

Limas rotativas de acero rápido HSS, Ojival con punta M=medio, EC=extra grueso



HSSG-G

Ø	Wavy	Box	Icon
6 mm	M	1	HSSG-G0618M
12 mm	M	1	HSSG-G1220M
12 mm	EC	1	HSSG-G1225EC
12 mm	M	1	HSSG-G1225M

F=Fino, M=Entrefino, C=Basto, EC= Extra Basto

Limas rotativas de acero rápido HSS, Ojival con punta, embalaje individual
M=medio, C=grueso, EC=extra grueso



HSSG-G-S

Ø	Wavy	Box	Icon
6 mm	M	1	HSSG-G0618M-S
12 mm	M	1	HSSG-G1220M-S
12 mm	M	1	HSSG-G1225M-S

F=Fino, M=Entrefino, C=Basto, EC= Extra Basto

Limas rotativas acero rápido, Cónica con punta M=medio, C=grueso, EC=extra grueso



HSSG-M

Ø	Wavy	Box	Icon
6 mm	M	1	HSSG-M0618M
12 mm	M	1	HSSG-M1227M

F=Fino, M=Entrefino, C=Basto, EC= Extra Basto

Limas rotativas de acero rápido HSS, Cónica con punta, embalaje individual
M=medio, C=grueso, EC=extra grueso



HSSG-M-S

Ø	Wavy	Box	Icon
6 mm	M	1	HSSG-M0618M-S
12 mm	M	1	HSSG-M1227M-S

F=Fino, M=Entrefino, C=Basto, EC= Extra Basto

BROCAS

Juego de 9 brocas helicoidales, de albañil y acero rápido



466-COMBI

X	g	Box	Icon
9	220	1	466-COMBI

441-5.0-CA, 441-6.0-CA, 441-8.0-CA

463-6-100, 463-5-85, 463-8-120

460-5-CA, 460-6-CA, 460-8-CA

Juego 6 brocas helicoidales 10,13,16,19,22,25mm



SB-9526/S6

Box	Icon
20	SB-9526/S6

9526-10, 9526-13, 9526-16, 9526-19, 9526-22, 9526-25

Broca para cemento, SDS Max best



4656

Ø	Box	Icon
12.0 mm	1	4656-12-340
12.0 mm	1	4656-12-540
12.0 mm	1	4656-12-690
14.0 mm	1	4656-14-340
14.0 mm	1	4656-14-540
15.0 mm	1	4656-15-340
15.0 mm	1	4656-15-540
16.0 mm	1	4656-16-340
16.0 mm	1	4656-16-540
16.0 mm	1	4656-16-1320
18.0 mm	1	4656-18-340
18.0 mm	1	4656-18-540
18.0 mm	1	4656-18-940
18.0 mm	1	4656-18-1320
20.0 mm	1	4656-20-320
20.0 mm	1	4656-20-520
20.0 mm	1	4656-20-920
20.0 mm	1	4656-20-1320
22.0 mm	1	4656-22-320
22.0 mm	1	4656-22-520
22.0 mm	1	4656-22-920
22.0 mm	1	4656-22-1320
24.0 mm	1	4656-24-320
24.0 mm	1	4656-24-520
25.0 mm	1	4656-25-320
25.0 mm	1	4656-25-520
25.0 mm	1	4656-25-920
25.0 mm	1	4656-25-1320
26.0 mm	1	4656-26-520
28.0 mm	1	4656-28-370



		
28.0 mm	1	4656-28-570
28.0 mm	1	4656-28-670
28.0 mm	1	4656-28-920
30.0 mm	1	4656-30-370
30.0 mm	1	4656-30-570
32.0 mm	1	4656-32-370
32.0 mm	1	4656-32-570
32.0 mm	1	4656-32-920
32.0 mm	1	4656-32-1320
35.0 mm	1	4656-35-370
35.0 mm	1	4656-35-570
35.0 mm	1	4656-35-670
37.0 mm	1	4656-37-370
37.0 mm	1	4656-37-570
37.0 mm	1	4656-37-920
38.0 mm	1	4656-38-370
38.0 mm	1	4656-38-570
40.0 mm	1	4656-40-370
40.0 mm	1	4656-40-570
40.0 mm	1	4656-40-920
40.0 mm	1	4656-40-1320
45.0 mm	1	4656-45-570
45.0 mm	1	4656-45-920
50.0 mm	1	4656-50-570
52.0 mm	1	4656-52-570



Broca para cemento, SDS best



4651



		
5.0 mm	1	4651-5-160
5.0 mm	1	4651-5-210
5.0 mm	1	4651-5-260
5.5 mm	1	4651-5,5-110
5.5 mm	1	4651-5,5-160
6.0 mm	1	4651-6-110
6.0 mm	1	4651-6-160
6.0 mm	1	4651-6-210
6.0 mm	1	4651-6-260
6.0 mm	1	4651-6-310
6.5 mm	1	4651-6,5-160
6.5 mm	1	4651-6,5-210
6.5 mm	1	4651-6,5-260
6.5 mm	1	4651-6,5-310
7.0 mm	1	4651-7-110
7.0 mm	1	4651-7-160
8.0 mm	1	4651-8-110
8.0 mm	1	4651-8-160
8.0 mm	1	4651-8-210
8.0 mm	1	4651-8-260
8.0 mm	1	4651-8-310
8.0 mm	1	4651-8-460
9.0 mm	1	4651-9-160
10.0 mm	1	4651-10-110
10.0 mm	1	4651-10-160
10.0 mm	1	4651-10-210
10.0 mm	1	4651-10-260



		
10.0 mm	1	4651-10-310
10.0 mm	1	4651-10-450
10.0 mm	1	4651-10-600
10.0 mm	1	4651-10-1000
12.0 mm	1	4651-12-160
12.0 mm	1	4651-12-210
12.0 mm	1	4651-12-260
12.0 mm	1	4651-12-310
12.0 mm	1	4651-12-450
12.0 mm	1	4651-12-600
12.0 mm	1	4651-12-1000
14.0 mm	1	4651-14-160
14.0 mm	1	4651-14-210
14.0 mm	1	4651-14-260
14.0 mm	1	4651-14-310
14.0 mm	1	4651-14-450
14.0 mm	1	4651-14-600
14.0 mm	1	4651-14-1000
15.0 mm	1	4651-15-160
15.0 mm	1	4651-15-260
15.0 mm	1	4651-15-450
16.0 mm	1	4651-16-160
16.0 mm	1	4651-16-210
16.0 mm	1	4651-16-260
16.0 mm	1	4651-16-310
16.0 mm	1	4651-16-450
16.0 mm	1	4651-16-600
16.0 mm	1	4651-16-1000
18.0 mm	1	4651-18-250
18.0 mm	1	4651-18-450
20.0 mm	1	4651-20-250
20.0 mm	1	4651-20-450
22.0 mm	1	4651-22-250
22.0 mm	1	4651-22-450
24.0 mm	1	4651-24-250
24.0 mm	1	4651-24-450
25.0 mm	1	4651-25-250
25.0 mm	1	4651-25-450
28.0 mm	1	4651-28-250
28.0 mm	1	4651-28-450
30.0 mm	1	4651-30-250
30.0 mm	1	4651-30-450
32.0 mm	1	4651-32-450



Brocas para cemento, SDS



4652



		
4.0 mm	1	4652-4-110
4.0 mm	1	4652-4-160
5.0 mm	1	4652-5-110
5.0 mm	1	4652-5-160
5.0 mm	1	4652-5-210
5.5 mm	1	4652-5,5-110
5.5 mm	1	4652-5,5-160
6.0 mm	1	4652-6-110
6.0 mm	1	4652-6-160

		
6.0 mm	1	4652-6-210
6.0 mm	1	4652-6-260
6.5 mm	1	4652-6,5-110
6.5 mm	1	4652-6,5-160
7.0 mm	1	4652-7-110
7.0 mm	1	4652-7-160
8.0 mm	1	4652-8-110
8.0 mm	1	4652-8-160
8.0 mm	1	4652-8-210
8.0 mm	1	4652-8-260
8.0 mm	1	4652-8-460
9.0 mm	1	4652-9-160
9.0 mm	1	4652-9-210
10.0 mm	1	4652-10-110
10.0 mm	1	4652-10-160
10.0 mm	1	4652-10-210
10.0 mm	1	4652-10-260
10.0 mm	1	4652-10-310
10.0 mm	1	4652-10-450
10.0 mm	1	4652-10-600
11.0 mm	1	4652-11-160
11.0 mm	1	4652-11-210
11.0 mm	1	4652-11-260
12.0 mm	1	4652-12-160
12.0 mm	1	4652-12-210
12.0 mm	1	4652-12-260
12.0 mm	1	4652-12-310
12.0 mm	1	4652-12-450
12.0 mm	1	4652-12-600
12.0 mm	1	4652-12-1000
13.0 mm	1	4652-13-160
13.0 mm	1	4652-13-310
14.0 mm	1	4652-14-160
14.0 mm	1	4652-14-210
14.0 mm	1	4652-14-260
14.0 mm	1	4652-14-310
14.0 mm	1	4652-14-450
14.0 mm	1	4652-14-600
14.0 mm	1	4652-14-1000
15.0 mm	1	4652-15-160
15.0 mm	1	4652-15-260
16.0 mm	1	4652-16-160
16.0 mm	1	4652-16-210
16.0 mm	1	4652-16-260
16.0 mm	1	4652-16-310
16.0 mm	1	4652-16-450
16.0 mm	1	4652-16-600
16.0 mm	1	4652-16-800
16.0 mm	1	4652-16-1000
18.0 mm	1	4652-18-200
18.0 mm	1	4652-18-300
18.0 mm	1	4652-18-450
18.0 mm	1	4652-18-1000
20.0 mm	1	4652-20-200
20.0 mm	1	4652-20-300
20.0 mm	1	4652-20-450
20.0 mm	1	4652-20-600
20.0 mm	1	4652-20-1000
22.0 mm	1	4652-22-250
22.0 mm	1	4652-22-450
22.0 mm	1	4652-22-600
22.0 mm	1	4652-22-1000
24.0 mm	1	4652-24-250
24.0 mm	1	4652-24-450
25.0 mm	1	4652-25-250
25.0 mm	1	4652-25-450
25.0 mm	1	4652-25-1000
26.0 mm	1	4652-26-250
26.0 mm	1	4652-26-450



Brocas para cemento



4641

Ø	Icon	Icon	Icon
3.0 mm	1	4641-3-60	
4.0 mm	1	4641-4-75	
5.0 mm	1	4641-5-85	
5.0 mm	1	4641-5-150	
5.5 mm	1	4641-5,5-85	
6.0 mm	1	4641-6-100	
6.0 mm	1	4641-6-150	
6.0 mm	1	4641-6-400	
6.5 mm	1	4641-6,5-100	
7.0 mm	1	4641-7-100	
8.0 mm	1	4641-8-120	
8.0 mm	1	4641-8-200	
8.0 mm	1	4641-8-400	
9.0 mm	1	4641-9-120	
10.0 mm	1	4641-10-120	
10.0 mm	1	4641-10-200	
10.0 mm	1	4641-10-400	
10.0 mm	1	4641-10-600	
11.0 mm	1	4641-11-150	
12.0 mm	1	4641-12-150	
12.0 mm	1	4641-12-200	
12.0 mm	1	4641-12-400	
12.0 mm	1	4641-12-600	
13.0 mm	1	4641-13-150	
14.0 mm	1	4641-14-150	
14.0 mm	1	4641-14-400	
14.0 mm	1	4641-14-600	
16.0 mm	1	4641-16-150	
16.0 mm	1	4641-16-400	
16.0 mm	1	4641-16-600	
18.0 mm	1	4641-18-400	
18.0 mm	1	4641-18-600	
20.0 mm	1	4641-20-400	
20.0 mm	1	4641-20-600	
22.0 mm	1	4641-22-400	
24.0 mm	1	4641-24-400	
25.0 mm	1	4641-25-400	

Juego de 5 brocas para cemento



4641-PB

X	g	Icon	Icon
5	185	1	4641-PB

4641-10-120, 4641-4-75, 4641-5-85, 4641-6-100, 4641-8-120

Brocas para cemento, cinceles SDS Max



4659

Ø	Icon	Icon	Icon
- mm	1	4659-POINT-28	
- mm	1	4659-POINT-40	
- mm	1	4659-POINT-60	
24.0 mm	1	4659-FLAT-28	
24.0 mm	1	4659-FLAT-40	
24.0 mm	1	4659-FLAT-60	
80.0 mm	1	4659-WIDE-30-8	
115.0 mm	1	4659-WIDE-35-11	
50.0 mm	1	4659-WIDE-36-5	
35.0 mm	1	4659-WING-C38-3	
50.0 mm	1	4659-TILE-30-5	
80.0 mm	1	4659-TILE-30-8	
110.0 mm	1	4659-SPADE-40	
45.0 mm	1	4659-BUSHING-24	
26.0 mm	1	4659-HOLLOW-30	

Brocas para cemento, cinceles SDS



4655

Ø	Icon	Icon	Icon
20.0 mm	1	4655-FLAT-250	
22.0 mm	1	4655-HOLLOW-240	
- mm	1	4655-POINT-250	
32.0 mm	1	4655-SLOT-25032	
38.0 mm	1	4655-TILE-20040	
60.0 mm	1	4655-TILE-25060	
38.0 mm	1	4655-WIDE-20040	
22.0 mm	1	4655-WING-C-250	

Broca para metal HSS-E, Cobalto



4411

Ø	Icon	Icon	Icon
1.00 mm	1	4411-1.00	
1.50 mm	1	4411-1.50	
2.00 mm	1	4411-2.00	
2.50 mm	1	4411-2.50	
3.00 mm	1	4411-3.00	



Ø	Icon	Icon
3.25 mm	1	4411-3.25
3.30 mm	1	4411-3.30
3.50 mm	1	4411-3.50
4.00 mm	1	4411-4.00
4.20 mm	1	4411-4.20
4.25 mm	1	4411-4.25
4.50 mm	1	4411-4.50
5.00 mm	1	4411-5.00
5.50 mm	1	4411-5.50
6.00 mm	1	4411-6.00
6.50 mm	1	4411-6.50
6.80 mm	1	4411-6.80
7.00 mm	1	4411-7.00
7.50 mm	1	4411-7.50
8.00 mm	1	4411-8.00
8.50 mm	1	4411-8.50
9.00 mm	1	4411-9.00
9.50 mm	1	4411-9.50
10.00 mm	1	4411-10.00
10.20 mm	1	4411-10.20
11.00 mm	1	4411-11.00
12.00 mm	1	4411-12.00
13.00 mm	1	4411-13.00



Broca para metal HSS-E, Cobalto Embalaje industrial



4511

Ø	Icon	Icon
0.50 mm	1	4511-0.50-10P
0.75 mm	1	4511-0.75-10P
1.00 mm	1	4511-1.00-10P
1.50 mm	1	4511-1.50-10P
1.75 mm	1	4511-1.75-10P
2.00 mm	1	4511-2.00-10P
2.50 mm	1	4511-2.50-10P
2.70 mm	1	4511-2.70-10P
2.90 mm	1	4511-2.90-10P
3.00 mm	1	4511-3.00-10P
3.10 mm	1	4511-3.10-10P
3.25 mm	1	4511-3.25-10P
3.30 mm	1	4511-3.30-10P
3.50 mm	1	4511-3.50-10P
3.80 mm	1	4511-3.80-10P
4.00 mm	1	4511-4.00-10P
4.20 mm	1	4511-4.20-10P
4.50 mm	1	4511-4.50-10P
4.80 mm	1	4511-4.80-10P
5.00 mm	1	4511-5.00-10P
5.20 mm	1	4511-5.20-10P
5.50 mm	1	4511-5.50-10P
6.00 mm	1	4511-6.00-10P
6.20 mm	1	4511-6.20-10P
6.50 mm	1	4511-6.50-10P
6.80 mm	1	4511-6.80-10P
7.00 mm	1	4511-7.00-10P
7.20 mm	1	4511-7.20-10P
7.50 mm	1	4511-7.50-10P
7.80 mm	1	4511-7.80-10P
8.00 mm	1	4511-8.00-10P
8.50 mm	1	4511-8.50-10P
8.60 mm	1	4511-8.60-10P

		
8.80 mm	1	4511-8.80-10P
9.00 mm	1	4511-9.00-10P
9.20 mm	1	4511-9.20-10P
9.50 mm	1	4511-9.50-10P
9.60 mm	1	4511-9.60-10P
10.00 mm	1	4511-10.00-5P
10.20 mm	1	4511-10.20-5P
10.30 mm	1	4511-10.30-5P
10.50 mm	1	4511-10.50-5P
10.80 mm	1	4511-10.80-5P
11.00 mm	1	4511-11.00-5P
11.50 mm	1	4511-11.50-5P
12.00 mm	1	4511-12.00-5P
12.50 mm	1	4511-12.50-5P
12.80 mm	1	4511-12.80-5P
13.00 mm	1	4511-13.00-5P
13.50 mm	1	4511-13.50-1P
14.00 mm	1	4511-14.00-1P
14.50 mm	1	4511-14.50-1P
15.00 mm	1	4511-15.00-1P
15.50 mm	1	4511-15.50-1P
16.00 mm	1	4511-16.00-1P
16.50 mm	1	4511-16.50-1P
17.00 mm	1	4511-17.00-1P
17.50 mm	1	4511-17.50-1P
18.00 mm	1	4511-18.00-1P
18.50 mm	1	4511-18.50-1P
19.00 mm	1	4511-19.00-1P
19.50 mm	1	4511-19.50-1P
20.00 mm	1	4511-20.00-1P

		
8.00 mm	1	4413-8.00
8.50 mm	1	4413-8.50
9.00 mm	1	4413-9.00
9.50 mm	1	4413-9.50
10.00 mm	1	4413-10.00
10.20 mm	1	4413-10.20
11.00 mm	1	4413-11.00
12.00 mm	1	4413-12.00
13.00 mm	1	4413-13.00

Broca para metal HSS-G Embalaje industrial



4513

		
1.00 mm	1	4513-1.00-10P
1.50 mm	1	4513-1.50-10P
1.75 mm	1	4513-1.75-10P
2.00 mm	1	4513-2.00-10P
2.50 mm	1	4513-2.50-10P
2.70 mm	1	4513-2.70-10P
2.90 mm	1	4513-2.90-10P
3.00 mm	1	4513-3.00-10P
3.10 mm	1	4513-3.10-10P
3.25 mm	1	4513-3.25-10P
3.30 mm	1	4513-3.30-10P
3.50 mm	1	4513-3.50-10P
3.80 mm	1	4513-3.80-10P
4.00 mm	1	4513-4.00-10P
4.20 mm	1	4513-4.20-10P
4.50 mm	1	4513-4.50-10P
4.80 mm	1	4513-4.80-10P
5.00 mm	1	4513-5.00-10P
5.20 mm	1	4513-5.20-10P
5.50 mm	1	4513-5.50-10P
6.00 mm	1	4513-6.00-10P
6.20 mm	1	4513-6.20-10P
6.50 mm	1	4513-6.50-10P
6.80 mm	1	4513-6.80-10P
7.00 mm	1	4513-7.00-10P
7.20 mm	1	4513-7.20-10P
7.50 mm	1	4513-7.50-10P
7.80 mm	1	4513-7.80-10P
8.00 mm	1	4513-8.00-10P
8.50 mm	1	4513-8.50-10P
8.60 mm	1	4513-8.60-10P
8.80 mm	1	4513-8.80-10P
9.00 mm	1	4513-9.00-10P
9.20 mm	1	4513-9.20-10P
9.50 mm	1	4513-9.50-10P
9.60 mm	1	4513-9.60-10P
10.00 mm	1	4513-10.00-5P
10.20 mm	1	4513-10.20-5P
10.30 mm	1	4513-10.30-5P

Broca para metal HSS-G



4413



		
1.00 mm	1	4413-1.00
1.50 mm	1	4413-1.50
2.00 mm	1	4413-2.00
2.50 mm	1	4413-2.50
3.00 mm	1	4413-3.00
3.25 mm	1	4413-3.25
3.30 mm	1	4413-3.30
3.50 mm	1	4413-3.50
4.00 mm	1	4413-4.00
4.20 mm	1	4413-4.20
4.25 mm	1	4413-4.25
4.50 mm	1	4413-4.50
5.00 mm	1	4413-5.00
5.50 mm	1	4413-5.50
6.00 mm	1	4413-6.00
6.50 mm	1	4413-6.50
6.80 mm	1	4413-6.80
7.00 mm	1	4413-7.00
7.50 mm	1	4413-7.50

		
10.50 mm	1	4513-10.50-5P
10.80 mm	1	4513-10.80-5P
11.00 mm	1	4513-11.00-5P
11.50 mm	1	4513-11.50-5P
12.00 mm	1	4513-12.00-5P
12.50 mm	1	4513-12.50-5P
12.80 mm	1	4513-12.80-5P
13.00 mm	1	4513-13.00-5P
13.50 mm	1	4513-13.50-1P
14.00 mm	1	4513-14.00-1P
14.50 mm	1	4513-14.50-1P
15.00 mm	1	4513-15.00-1P
15.50 mm	1	4513-15.50-1P
16.00 mm	1	4513-16.00-1P
16.50 mm	1	4513-16.50-1P
17.00 mm	1	4513-17.00-1P
17.50 mm	1	4513-17.50-1P
18.00 mm	1	4513-18.00-1P
18.50 mm	1	4513-18.50-1P
19.00 mm	1	4513-19.00-1P
19.50 mm	1	4513-19.50-1P
20.00 mm	1	4513-20.00-1P

Broca para metal HSS-R



4415

		
1.00 mm	1	4415-1.00
1.50 mm	1	4415-1.50
2.00 mm	1	4415-2.00
2.50 mm	1	4415-2.50
3.00 mm	1	4415-3.00
3.25 mm	1	4415-3.25
3.50 mm	1	4415-3.50
4.00 mm	1	4415-4.00
4.25 mm	1	4415-4.25
4.50 mm	1	4415-4.50
5.00 mm	1	4415-5.00
5.50 mm	1	4415-5.50
6.00 mm	1	4415-6.00
6.50 mm	1	4415-6.50
7.00 mm	1	4415-7.00
7.50 mm	1	4415-7.50
8.00 mm	1	4415-8.00
8.50 mm	1	4415-8.50
9.00 mm	1	4415-9.00
10.00 mm	1	4415-10.00
11.00 mm	1	4415-11.00
12.00 mm	1	4415-12.00
13.00 mm	1	4415-13.00



Juego de 19 brocas para metal



4513-SET-19

19	600	1	4513-SET-19

4413-1.00, 4413-1.50, 4413-10.00, 4413-2.00,
4413-2.50, 4413-3.00, 4413-3.50, 4413-4.00,
4413-4.50, 4413-5.00, 4413-5.50, 4413-6.00,
4413-6.50, 4413-7.00, 4413-7.50, 4413-8.00,
4413-8.50, 4413-9.00, 4413-9.50

Juego de 25 brocas para metal



4513-SET-25

25	1200	1	4513-SET-25

Juego de 6 brocas para metal



4513-SET-6

6	150	1	4513-SET-6

4413-2.00, 4413-3.00, 4413-4.00, 4413-5.00,
4413-6.00, 4413-8.00

Juego de 19 brocas para metal



4515-SET-19

19	600	1	4515-SET-19

Juego de 19 brocas para metal, Cobalto



4511-SET-19

19	600	1	4511-SET-19

4411-1.00, 4411-1.50, 4411-10.00, 4411-2.00,
4411-2.50, 4411-3.00, 4411-3.50, 4411-4.00,
4411-4.50, 4411-5.00, 4411-5.50, 4411-6.00,
4411-6.50, 4411-7.00, 4411-7.50, 4411-8.00,
4411-8.50, 4411-9.00, 4411-9.50

Juego de 25 brocas para metal, Cobalto



4511-SET-25

25	1200	1	4511-SET-25

Juego de 6 brocas para metal, Cobalto



4511-SET-6

6	150	1	4511-SET-6

4411-2.00, 4411-3.00, 4411-4.00, 4411-5.00,
4411-6.00, 4411-8.00

Broca escalonada de 4 a 12 mm



228-SD

6.35 mm	4-12 / 1 mm	24	228-SD

Broca escalonada de 4 a 22 mm



229-SD

10 mm	4-22 / 2 mm	24	229-SD

Broca escalonada de 13 niveles
5-13-15-17-19-21-23-25-27-29-31-33-35 mm



230-SD

12.7 mm	5-35 mm	25	230-SD

Broca escalonada 6 a 37mm



232-SD

10 mm	6-37 mm	1	232-SD

Broca escalonada 6.5 a 40.5mm



234-SD

10 mm	6.5-40.5 mm	25	234-SD

Juego brocas escalonadas acero rápido 4-30mm



228-SET

3	560	1	228-SET-SD

228-SD	
229-SD	
230-SD	

Broca de diámetro variable



9528

15-45 mm	10	9528-MD-15-45
22-76 mm	10	9528-MD-22-76

Broca helicoidal para madera



9626

6.0 mm	1	9626-6
8.0 mm	1	9626-8
9.0 mm	1	9626-9
10.0 mm	1	9626-10
11.0 mm	1	9626-11
12.0 mm	1	9626-12
13.0 mm	1	9626-13
14.0 mm	1	9626-14
16.0 mm	1	9626-16
18.0 mm	1	9626-18
20.0 mm	1	9626-20
22.0 mm	1	9626-22
23.0 mm	1	9626-23
24.0 mm	1	9626-24
25.0 mm	1	9626-25
26.0 mm	1	9626-26
28.0 mm	1	9626-28
30.0 mm	1	9626-30
32.0 mm	1	9626-32
6.0 mm	1	9627-6-460
8.0 mm	1	9627-8-460
10.0 mm	1	9627-10-460
12.0 mm	1	9627-12-460
14.0 mm	1	9627-14-460
16.0 mm	1	9627-16-460
18.0 mm	1	9627-18-460
20.0 mm	1	9627-20-460
22.0 mm	1	9627-22-460
24.0 mm	1	9627-24-460
26.0 mm	1	9627-26-460
28.0 mm	1	9627-28-460
30.0 mm	1	9627-30-460
32.0 mm	1	9627-32-460



Brocas para madera, punta plana



9629

6.0 mm	1	9629-6
8.0 mm	1	9629-8
10.0 mm	1	9629-10
12.0 mm	1	9629-12
14.0 mm	1	9629-14





		
16.0 mm	1	9629-16
18.0 mm	1	9629-18
20.0 mm	1	9629-20
22.0 mm	1	9629-22
24.0 mm	1	9629-24
25.0 mm	1	9629-25
26.0 mm	1	9629-26
28.0 mm	1	9629-28
30.0 mm	1	9629-30
32.0 mm	1	9629-32
36.0 mm	1	9629-36
38.0 mm	1	9629-38
40.0 mm	1	9629-40
6.0 mm	1	9631-6-400
8.0 mm	1	9631-8-400
10.0 mm	1	9631-10-400
12.0 mm	1	9631-12-400
14.0 mm	1	9631-14-400
16.0 mm	1	9631-16-400
18.0 mm	1	9631-18-400
20.0 mm	1	9631-20-400
22.0 mm	1	9631-22-400
24.0 mm	1	9631-24-400
28.0 mm	1	9631-28-400
30.0 mm	1	9631-30-400
32.0 mm	1	9631-32-400

Broca helicoidal para madera





9646

		
3 mm	1	9646-3
4 mm	1	9646-4
5 mm	1	9646-5
6 mm	1	9646-6
7 mm	1	9646-7
8 mm	1	9646-8
9 mm	1	9646-9
10 mm	1	9646-10
11 mm	1	9646-11
12 mm	1	9646-12
13 mm	1	9646-13
14 mm	1	9646-14
15 mm	1	9646-15
16 mm	1	9646-16
18 mm	1	9646-18
20 mm	1	9646-20
6 mm	1	9646-6-250
8 mm	1	9646-8-250
10 mm	1	9646-10-250
12 mm	1	9646-12-250

Extensión de 330 mm para brocas de 3 puntas



9525





		
14-19	1	9525-7
20-32	1	9525-10

PUNTAS PARA ATORNILLAR

Punta de torsión Phillips ACR - 25 mm







64A/PH

			
10	1	1	64A/PH1
2	1	1	64A/PH1-2P
10	2	1	64A/PH2
2	2	1	64A/PH2-2P
10	3	1	64A/PH3
2	3	1	64A/PH3-2P

Punta de torsión Pozidriv ACR - 25 mm







64A/PZ

			
10	1	1	64A/PZ1
2	1	1	64A/PZ1-2P
10	2	1	64A/PZ2
2	2	1	64A/PZ2-2P
10	3	1	64A/PZ3
2	3	1	64A/PZ3-2P

Punta diamante Phillips - 25 mm







63D/PH

			
5	1	1	63D/PH1
2	1	1	63D/PH1-2P
5	2	1	63D/PH2
2	2	1	63D/PH2-2P
5	3	1	63D/PH3
2	3	1	63D/PH3-2P

Punta diamante Grabber Phillips - 25 mm







63D/PH2G

			
5	PH2G	1	63D/PH2G
2	PH2G	1	63D/PH2G-2P

Punta diamante Pozidriv - 25 mm



63D/PZ

			
5	1	1	63D/PZ1
2	1	1	63D/PZ1-2P
5	2	1	63D/PZ2
2	2	1	63D/PZ2-2P
5	3	1	63D/PZ3
2	3	1	63D/PZ3-2P

Punta diamante Torx - 25 mm



63D/T

X			
5	T10	1	63D/T10
2	T10	1	63D/T10-2P
5	T15	1	63D/T15
2	T15	1	63D/T15-2P
5	T20	1	63D/T20
2	T20	1	63D/T20-2P
5	T25	1	63D/T25
2	T25	1	63D/T25-2P
5	T30	1	63D/T30
2	T30	1	63D/T30-2P
5	T40	1	63D/T40
2	T40	1	63D/T40-2P

Caja 5 Puntas Phillips de diamante, 50 mm



63D/50PH

X			
5	1	1	63D/50PH1
5	2	1	63D/50PH2
5	3	1	63D/50PH3

Caja 5 Puntas Pozidriv de diamante, 50 mm



63D/50PZ

X			
5	1	1	63D/50PZ1
5	2	1	63D/50PZ2
5	3	1	63D/50PZ3

Juego de 6 puntas de diamante Phillips, Pozidriv, TORX® y adaptador



63D/7

X			
7	20 x 50 x 80 mm	1	63D/7-1

63D/PH2			
63D/PZ2			
63D/T10, 63D/T15, 63D/T25, 63D/T30			

Punta de torsión Phillips extra dura - 25 mm



61H/PH

X			
10	1	1	61H/PH1
2	1	1	61H/PH1-2P
10	2	1	61H/PH2
2	2	1	61H/PH2-2P
5	3	1	61H/PH3
2	3	1	61H/PH3-2P

Punta de torsión Phillips extra dura - 50 mm



61H/50PH

X			
5	1	1	61H/50PH1
2	1	1	61H/50PH1-2P
5	2	1	61H/50PH2
2	2	1	61H/50PH2-2P
5	3	1	61H/50PH3
2	3	1	61H/50PH3-2P

Punta de torsión Pozidriv extra dura - 25 mm



61H/PZ

X			
10	1	1	61H/PZ1
2	1	1	61H/PZ1-2P
10	2	1	61H/PZ2
2	2	1	61H/PZ2-2P
5	3	1	61H/PZ3
2	3	1	61H/PZ3-2P

Punta de torsión Pozidriv extra dura - 50 mm



61H/50PZ

X			
5	1	1	61H/50PZ1
2	1	1	61H/50PZ1-2P
5	2	1	61H/50PZ2
2	2	1	61H/50PZ2-2P
5	3	1	61H/50PZ3
2	3	1	61H/50PZ3-2P

Punta de torsión Torx extra dura - 50 mm



61H/50T

X			
5	T10	1	61H/50T10
2	T10	1	61H/50T10-2P
5	T15	1	61H/50T15
2	T15	1	61H/50T15-2P
5	T20	1	61H/50T20
2	T20	1	61H/50T20-2P
5	T25	1	61H/50T25
2	T25	1	61H/50T25-2P
5	T30	1	61H/50T30
2	T30	1	61H/50T30-2P
5	T40	1	61H/50T40
2	T40	1	61H/50T40-2P



Punta de torsión Torx extra dura - 25 mm



61H/T

10				
2				
10				
2				
10				
2				
10				
2				
10				
2				
10				
2				
5				
2				

Caja 5 Adaptadores con imán con sistema de ajuste rápido, 60mm. KM653-QR en caja de plástico de 5 piezas y KM653-QR-1 en colgador de plástico por unidad



KM653-QR

5				
1				

KM653-QR-1P Envase unitario

Adaptador de ajuste rápido magnético, 75 mm
En colgador de plástico por unidad



KM753-QR

1				

Adaptador para puntas 1/4" con imán sujeta tornillos, 82mm
En colgador de plástico por unidad



KM100-SH

1				

Caja 5 Adaptadores universales de 1/4" con anilla de retención, 60 mm



KR653

1				
5				

Caja 5 Adaptadores con imán sin anillo interno KM653 en caja de plástico de 5 piezas y KM653-1P en colgador de plástico por unidad



KM653

1				
5				

KM653-1P Envase unitario

Adaptador angular de 1/4"
Portapuntas con función giratoria, 60mm



KM653-SF

1				

Caja 5 Adaptadores universales magnéticos de 1/4" con anilla de retención 60mm. KM653 en caja de plástico de 5 piezas y KM653-1P en colgador de plástico por unidad



KMR653

1				
5				

-1P: Envase unitario en soporte plástico

Caja 5 Adaptadores universales magnéticos de 1/4" con anilla de retención 75mm



KMR753

1				
5				

-1P: Envase unitario en soporte plástico

Adaptador magnético para puntas 5/16"
En colgador de plástico por unidad



KM1/4-5/16-1P

1	1/4"	50	KM1/4-5/16-1P

Adaptador universal de 1/4" de cobre-berilio
Con anilla de retención



KCB753

1	1/4"	1	KCB753

Caja 5 Adaptadores universales magnéticos de 1/4" con anilla de retención 150mm. KMR150 in plastic box of 5 piezas y KMR150-1P in plastic holder by unit



KMR150

1	1/4"	1	KMR150-1P
5	1/4"	1	KMR150

-1P: Envase unitario en soporte plástico

Caja 5 Adaptadores hexágono 1/4" y cuadrado 1/4", 25mm



K6625

1	1/4"	1	K6625-1/4-1P
5	1/4"	1	K6625-1/4

-1P: Envase unitario en soporte plástico

Caja 5 Adaptadores cuadrado 1/4" y hexágono 3/8" 38mm



K6638

1	1/4"	25	K6638-3/8-1P
5	1/4"	1	K6638-3/8

1P: Envase unitario soporte plástico

Caja 5 adaptadores hexágono y cuadrado, 50 mm K6650-1/4-1P se suministra unitariamente



K6650

1	1/4"	1	K6650-1/4-1P
5	1/4"	1	K6650-1/4
1	1/4"	1	K6650-3/8-1P
5	1/4"	1	K6650-3/8
1	1/4"	1	K6650-1/2-1P
5	1/4"	1	K6650-1/2

-1P: Envase unitario en soporte plástico
Con pivote (excepto K6650-1/4-1P con bola)

Caja 5 Adaptadores hexágono y cuadrado, 100 mm



K66100

1	1/4"	25	K66100-1/4-1P
5	1/4"	1	K66100-1/4
1	1/4"	25	K66100-3/8-1P
5	1/4"	1	K66100-3/8

K66100-1/4 con pivote
K66100-3/8 con bola
1P: Envase unitario soporte plástico

Adaptador de ajuste rápido de 1/4", 60 mm



K6660-QR

1	1/4"	1	K6660-QR-1P

Adaptador para puntas de destorgolpe



54640

40		1	54640

Cuadrado 1/2" Para puntas 5/16"
Para destornillador ref. 5521

Destornillador de impacto 1/2" para puntas 5/16"



5521

125		1	5521



Puntas para tornillos ranurados



70S/

5	8.0	1 70S/1.2-8.0
2	8.0	25 70S/1.2-8.0-2P
5	9.0	1 70S/1.6-9.0
2	9.0	25 70S/1.6-9.0-2P
5	10.0	1 70S/1.6-10.0
2	10.0	25 70S/1.6-10.0-2P
5	12.0	1 70S/2.0-12.0
2	12.0	25 70S/2.0-12.0-2P
5	14.0	1 70S/2.5-14.0
2	14.0	25 70S/2.5-14.0-2P

Puntas para tornillos Phillips



70S/PH

5	1	1 70S/PH1
2	1	25 70S/PH1-2P
5	2	1 70S/PH2
2	2	25 70S/PH2-2P
5	3	1 70S/PH3
2	3	25 70S/PH3-2P
5	4	1 70S/PH4
2	4	25 70S/PH4-2P

Puntas para tornillos Pozidriv®



70S/PZ

5	1	1 70S/PZ1
2	1	25 70S/PZ1-2P
5	2	1 70S/PZ2
2	2	25 70S/PZ2-2P

5	3	1 70S/PZ3
2	3	25 70S/PZ3-2P
5	4	1 70S/PZ4
2	4	25 70S/PZ4-2P

Puntas para tornillos TORX® 5/16", 35mm



70S/T

5	T20	1 70S/T20
2	T20	25 70S/T20-2P
5	T25	1 70S/T25
2	T25	25 70S/T25-2P
5	T27	1 70S/T27
2	T27	1 70S/T27-2P
5	T30	1 70S/T30
2	T30	25 70S/T30-2P
5	T40	1 70S/T40
2	T40	25 70S/T40-2P
5	T45	1 70S/T45
2	T45	25 70S/T45-2P
5	T50	1 70S/T50
2	T50	25 70S/T50-2P
5	T55	1 70S/T55
2	T55	25 70S/T55-2P

Puntas para tornillos Torque-set®



70S/TS

5	8 mm	1 70S/TS8
2	8 mm	25 70S/TS8-2P
5	10 mm	1 70S/TS10
2	10 mm	25 70S/TS10-2P

Puntas de impacto Torq-Set® -32 mm



70S/TS"

5	1/4"	1 70S/TS1/4
2	1/4"	25 70S/TS1/4-2P
5	5/16"	1 70S/TS5/16
2	5/16"	25 70S/TS5/16-2P

Puntas para tornillos Hexagonales



70S/H

5	4	1 70S/H4
2	4	25 70S/H4-2P
5	5	1 70S/H5
2	5	25 70S/H5-2P
5	6	1 70S/H6
2	6	25 70S/H6-2P
5	7	1 70S/H7
2	7	25 70S/H7-2P
5	8	1 70S/H8
2	8	25 70S/H8-2P
5	10	1 70S/H10
2	10	25 70S/H10-2P
5	12	1 70S/H12
2	12	25 70S/H12-2P
5	14	1 70S/H14
2	14	25 70S/H14-2P

Puntas para tornillos hexagonales 7/16"



74S/H

5	4	1 74S/H4
2	4	25 74S/H4-2P

5	5	1	74S/H5
2	5	25	74S/H5-2P
5	6	1	74S/H6
2	6	25	74S/H6-2P
5	7	1	74S/H7
2	7	25	74S/H7-2P
5	8	1	74S/H8
2	8	25	74S/H8-2P
5	10	1	74S/H10
2	10	25	74S/H10-2P
5	12	1	74S/H12
2	12	25	74S/H12-2P
5	14	1	74S/H14
2	14	1	74S/H14-2P
5	17	1	74S/H17
2	17	25	74S/H17-2P

Juego de puntas y destornillador a golpe cuadrado 1/2"



7823

23	45 x 70 x 197 mm	16	7823

22 Puntas 5/16" (3 boca recta, 3 phillips, 8 hex, 8 Torx®)

5521			
54640			
70S/1.2-8.0, 70S/1.6-10.0, 70S/2.0-12.0			
70S/PH2, 70S/PH3, 70S/PH4			
70S/T20, 70S/T25, 70S/T27, 70S/T30, 70S/T40, 70S/T45, 70S/T50, 70S/T55			
70S/H10, 70S/H12, 70S/H14, 70S/H4, 70S/H5, 70S/H6, 70S/H7, 70S/H8			

Juego de destornillador a golpe con puntas: Recta, Phillips®, Pozidriv®, Torx®, hexagonales y adaptador



7865

15	55 x 90 x 220 mm	1	7865

5521			
54640			
70S/1.2-8.0, 70S/1.6-10.0			
70S/PH1, 70S/PH2, 70S/PH3, 70S/PH4			
70S/H4, 70S/H5, 70S/H6, 70S/H8			

Adaptador, 50 mm



K6750

1	1/4"	1	K6750-6
1	1/4"	1	K6750-7
1	1/4"	1	K6750-8
1	1/4"	1	K6750-10
1	1/4"	1	K6750-13
1	1/4"	1	K6750-1/4
1	1/4"	1	K6750-3/8

Adaptador magnético, 50 mm



KM6750

1		1	KM6750-6
1		1	KM6750-7
1		1	KM6750-8
1		20	KM6750-10
1		1	KM6750-11
1		1	KM6750-13
1		1	KM6750-1/4
1		1	KM6750-3/8

Punta estándar ranurada - 25 mm



59S/

10	3.0	1	59S/0.5-3.0
3	3.0	50	59S/0.5-3.0-3P
10	4.0	1	59S/0.5-4.0
3	4.0	50	59S/0.5-4.0-3P
10	3.5	1	59S/0.6-3.5
3	3.5	50	59S/0.6-3.5-3P
10	4.5	1	59S/0.6-4.5
3	4.5	1	59S/0.6-4.5-3P
10	5.5	1	59S/0.8-5.5
3	5.5	1	59S/0.8-5.5-3P
10	5.5	1	59S/1.0-5.5
3	5.5	50	59S/1.0-5.5-3P
10	6.5	1	59S/1.2-6.5
3	6.5	50	59S/1.2-6.5-3P
10	8.0	1	59S/1.2-8.0
3	8.0	1	59S/1.2-8.0-3P
10	9.0	1	59S/1.6-9.0
10	10	1	59S/1.6-10
3	9.0	50	59S/1.6-9.0-3P
3	10.0	50	59S/1.6-10-3P

Punta estándar Phillips - 25 mm



59S/PH

10	0	1	59S/PH0
3	0	50	59S/PH0-3P
10	1	1	59S/PH1
3	1	1	59S/PH1-3P
30	1	1	59S/PH1-30P
100	*1	100	59S/PH1-IP
500	1	500	59S/PH1-IPB
10	2	1	59S/PH2
3	2	1	59S/PH2-3P
30	2	1	59S/PH2-30P
100	*2	100	59S/PH2-IP
500	*2	500	59S/PH2-IPB
10	3	1	59S/PH3
3	3	1	59S/PH3-3P
30	3	1	59S/PH3-30P
500	3	500	59S/PH3-IPB
10	4	1	59S/PH4
3	4	25	59S/PH4-3P



Punta estándar Grabber Phillips - 25 mm



59S/PH2G

Quantity	Model	Quantity	Model
10	PH 2G	1	59S/PH2G
3	PH 2G	50	59S/PH2G-3P
30	PH2G	1	59S/PH2G-30P

Punta estándar Pozidriv - 25 mm



59S/PZ

Quantity	Model	Quantity	Model
10	0	1	59S/PZ0
3	0	50	59S/PZ0-3P
10	1	1	59S/PZ1
3	1	1	59S/PZ1-3P
30	1	1	59S/PZ1-30P
100	*1	100	59S/PZ1-IP
500	*1	500	59S/PZ1-IPB
10	2	1	59S/PZ2
3	2	1	59S/PZ2-3P
30	2	1	59S/PZ2-30P
100	*2	100	59S/PZ2-IP
500	*2	500	59S/PZ2-IPB
10	3	1	59S/PZ3
3	3	1	59S/PZ3-3P
30	3	1	59S/PZ3-30P
500	3	500	59S/PZ3-IPB
10	4	1	59S/PZ4

Punta estándar Torx - 25 mm



59S/T

Quantity	Model	Quantity	Model
5	T3	1	59S/T3

Quantity	Model	Quantity	Model
3	T3	50	59S/T3-3P
5	T4	1	59S/T4
3	T4	50	59S/T4-3P
5	T5	1	59S/T5
3	T5	50	59S/T5-3P
10	T6	1	59S/T6
3	T6	50	59S/T6-3P
10	T7	1	59S/T7
3	T7	50	59S/T7-3P
10	T8	1	59S/T8
3	T8	50	59S/T8-3P
10	T9	1	59S/T9
3	T9	50	59S/T9-3P
10	T10	1	59S/T10
3	T10	1	59S/T10-3P
30	T10	1	59S/T10-30P
10	T15	1	59S/T15
3	T15	1	59S/T15-3P
30	T15	1	59S/T15-30P
10	T20	1	59S/T20
3	T20	1	59S/T20-3P
30	T20	1	59S/T20-30P
10	T25	1	59S/T25
3	T25	1	59S/T25-3P
30	T25	1	59S/T25-30P
10	T27	1	59S/T27
3	T27	1	59S/T27-3P
5	T30	1	59S/T30
3	T30	1	59S/T30-3P
30	T30	1	59S/T30-30P
5	T40	1	59S/T40
3	T40	1	59S/T40-3P
30	T40	1	59S/T40-30P
5	T45	1	59S/T45
3	T45	50	59S/T45-3P
5	T50	1	59S/T50
3	T50	50	59S/T50-3P

Punta estándar Torx Tamper - 25 mm



59S/TR

Quantity	Model	Quantity	Model
5	TR 7	1	59S/TR7
3	TR7	50	59S/TR7-3P
5	TR 8	1	59S/TR8
3	TR8	50	59S/TR8-3P
5	TR 9	1	59S/TR9
3	TR9	50	59S/TR9-3P
5	TR 10	1	59S/TR10
3	TR 10	1	59S/TR10-3P
5	TR 15	1	59S/TR15
3	TR 15	1	59S/TR15-3P
5	TR 20	1	59S/TR20
3	TR 20	1	59S/TR20-3P
5	TR 25	1	59S/TR25
3	TR 25	1	59S/TR25-3P
5	TR 27	1	59S/TR27
3	TR 27	1	59S/TR27-3P
5	TR 30	1	59S/TR30

Quantity	Model	Quantity	Model
3	TR 30	1	59S/TR30-3P
5	TR 40	1	59S/TR40
3	TR 40	1	59S/TR40-3P

Punta estándar hexagonal métrica - 25 mm



59S/H mm





Quantity	Model	Quantity	Model
5	1.5	1	59S/H1.5
3	1.5	50	59S/H1.5-3P
5	2	1	59S/H2
3	2	50	59S/H2-3P
5	2.5	1	59S/H2.5
3	2.5	50	59S/H2.5-3P
5	3	1	59S/H3
3	3	1	59S/H3-3P
5	4	1	59S/H4
3	4	1	59S/H4-3P
500	4	500	59S/H4-IPB
5	5	1	59S/H5
3	5	1	59S/H5-3P
5	6	1	59S/H6
3	6	1	59S/H6-3P
5	8	1	59S/H8
3	8	1	59S/H8-3P
5	10	1	59S/H10
3	10	25	59S/H10-3P

Punta estándar hexagonal Imperial - 25 mm



59S/H "





Quantity	Model	Quantity	Model
5	1/4	1	59S/H1/16
3	1/8	50	59S/H1/16-3P
5	1/16	1	59S/H5/64
3	3/8	50	59S/H5/64-3P
5	3/16	1	59S/H3/32
3	3/32	50	59S/H3/32-3P
5	5/16	1	59S/H7/64
3	5/32	50	59S/H7/64-3P
5	5/64	1	59S/H1/8
3	7/32	50	59S/H1/8-3P
5	7/64	1	59S/H9/64
3	9/64	1	59S/H9/64-3P

   		
5	1	59S/H5/32
3	50	59S/H5/32-3P
5	1	59S/H3/16
3	1	59S/H3/16-3P
5	1	59S/H7/32
3	50	59S/H7/32-3P
5	1	59S/H1/4
3	50	59S/H1/4-3P
5	1	59S/H5/16
3	50	59S/H5/16-3P
5	1	59S/H3/8
3	25	59S/H3/8-3P

Punta estándar Robertson - 25 mm







59S/R

   		
10	# 1	1 59S/R1
3		1 59S/R1-3P
10	# 2	1 59S/R2
3		1 59S/R2-3P
10	# 3	1 59S/R3
3		1 59S/R3-3P
10	# 4	1 59S/R4

Caja 5 Puntas TORQ-SET®, 25 mm





59S/TS

   		
5	0	1 59S/TS-0
5	1	1 59S/TS-1
5	2	1 59S/TS-2
5	3	1 59S/TS-3
5	4	1 59S/TS-4
5	5	1 59S/TS-5
5	6	1 59S/TS-6
5	8	1 59S/TS-8
5	10	1 59S/TS-10

Puntas de impacto Torq-Set® -25 mm







59S/TS "

   		
5	1/4"	1 59S/TS-1/4

Caja 5 Puntas Tri-Wing, 25 mm







59S/TW

   		
5	TW 0	1 59S/TW0
5	TW 1	1 59S/TW1
5	TW 2	1 59S/TW2
5	TW 3	1 59S/TW3
5	TW 4	1 59S/TW4
5	TW 5	1 59S/TW5

Punta estándar XZN - 25 mm







59S/M

   		
10	M3	1 59S/M3
3	M3	50 59S/M3-3P
10	M4	1 59S/M4
3	M4	50 59S/M4-3P
10	M5	1 59S/M5
3	M5	50 59S/M5-3P
10	M6	1 59S/M6
3	M6	50 59S/M6-3P
10	M8	1 59S/M8
3	M8	50 59S/M8-3P

Punta estándar ranurada - 50 mm







59S/50

   		
5	3.5	1 59S/50/0.6-3.5
5	4.0	1 59S/50/0.8-4.0
5	5.5	1 59S/50/0.8-5.5
5	6.0	1 59S/50/1.0-6.0
5	6.5	1 59S/50/1.2-6.5
2	3.5	50 59S/50/3.5-2P
2	4.0	50 59S/50/4.0-2P
2	5.5	50 59S/50/5.5-2P
2	6.0	1 59S/50/6.0-2P
2	6.5	50 59S/50/6.5-2P

Punta estándar Phillips - 50 mm







59S/50PH

   		
5	1	1 59S/50PH1
2	1	1 59S/50PH1-2P
5	2	1 59S/50PH2
2	2	1 59S/50PH2-2P
5	3	1 59S/50PH3
2	3	1 59S/50PH3-2P

Punta estándar Pozidriv - 50 mm



59S/50PZ

   		
5	1	1 59S/50PZ1
2	1	1 59S/50PZ1-2P
5	2	1 59S/50PZ2
2	2	1 59S/50PZ2-2P
5	3	1 59S/50PZ3
2	3	1 59S/50PZ3-2P



Punta estándar Torx - 50 mm



59S/50T

QTY	SIZE	QTY	ITEM
5	T 8	1	59S/50T8
2	T 8	50	59S/50T8-2P
5	T 10	1	59S/50T10
2	T 10	1	59S/50T10-2P
5	T 15	1	59S/50T15
2	T 15	1	59S/50T15-2P
5	T 20	1	59S/50T20
2	T 20	1	59S/50T20-2P
5	T 25	1	59S/50T25
2	T 25	1	59S/50T25-2P
5	T 27	1	59S/50T27
5	T 30	1	59S/50T30
2	T 30	1	59S/50T30-2P
5	T 40	1	59S/50T40
2	T 40	50	59S/50T40-2P

Punta estándar métrica hexagonal - 50 mm



59S/50H

QTY	SIZE	QTY	ITEM
5	2	1	59S/50H2
2	2	50	59S/50H2-2P
5	2.5	1	59S/50H2.5
2	2.5	50	59S/50H2.5-2P
5	3	1	59S/50H3
2	3	50	59S/50H3-2P
5	4	1	59S/50H4
2	4	50	59S/50H4-2P
5	5	1	59S/50H5
2	5	50	59S/50H5-2P
5	6	1	59S/50H6
2	6	50	59S/50H6-2P
5	8	1	59S/50H8
2	8	50	59S/50H8-2P

Caja 5 Puntas hexagonales en pulgadas, 50 mm



59S/50H "

QTY	SIZE	QTY	ITEM
5	1/16	1	59S/50H1/16
5	5/64	1	59S/50H5/64
5	3/32	1	59S/50H3/32
5	7/64	1	59S/50H7/64
5	1/8	1	59S/50H1/8
5	9/64	1	59S/50H9/64
5	5/32	1	59S/50H5/32
5	3/16	1	59S/50H3/16
5	7/32	1	59S/50H7/32
5	1/4	1	59S/50H1/4
5	5/16	1	59S/50H5/16
5	3/8	1	59S/50H3/8

Punta estándar Robertson - 50 mm



59S/50R

QTY	SIZE	QTY	ITEM
5	#1	1	59S/50R1
2	#1	50	59S/50R1-2P
5	#2	1	59S/50R2
2	#2	50	59S/50R2-2P
5	#3	1	59S/50R3
2	#3	50	59S/50R3-2P

Punta estándar Phillips - 70 mm



59S/70PH

QTY	SIZE	QTY	ITEM
5	1	1	59S/70PH1
2	1	1	59S/70PH1-2P
5	2	1	59S/70PH2
2	2	25	59S/70PH2-2P

Punta estándar Pozidriv - 70 mm



59S/70PZ

QTY	SIZE	QTY	ITEM
5	1	1	59S/70PZ1
2	1	1	59S/70PZ1-2P
5	2	1	59S/70PZ2
2	2	1	59S/70PZ2-2P
5	3	1	59S/70PZ3
2	3	1	59S/70PZ3-2P

Punta estándar Torx - 70 mm



59S/70T

QTY	SIZE	QTY	ITEM
5	T10	1	59S/70T10
2	T10	1	59S/70T10-2P
5	T15	1	59S/70T15
2	T15	25	59S/70T15-2P
2	T20	1	59S/70T20-2P
5	T20	1	59S/70T20
2	T25	25	59S/70T25-2P
5	T25	1	59S/70T25
2	T27	1	59S/70T27-2P
5	T27	1	59S/70T27
2	T30	1	59S/70T30-2P
5	T30	1	59S/70T30
2	T40	1	59S/70T40-2P
5	T40	1	59S/70T40

Punta estándar Torx Tamper - 70 mm



59S/70TR

QTY	SIZE	QTY	ITEM
5	TR15	1	59S/70TR15
2	TR15	1	59S/70TR15-2P
5	TR20	1	59S/70TR20

2	TR20	25	59S/70TR20-2P
5	TR25	1	59S/70TR25
2	TR25	25	59S/70TR25-2P
5	TR27	1	59S/70TR27
2	TR27	25	59S/70TR27-2P
5	TR30	1	59S/70TR30
2	TR30	25	59S/70TR30-2P
5	TR40	1	59S/70TR40
2	TR40	25	59S/70TR40-2P

Punta estándar Phillips - 125 mm



59S/125PH

5	1	1	59S/125PH1
2	1	25	59S/125PH1-2P
5	2	1	59S/125PH2
2	2	25	59S/125PH2-2P
5	3	1	59S/125PH3
2	3	25	59S/125PH3-2P

Punta estándar de bola hexagonal - 89 mm



59S/H BALL

5	3	1	59S/H3BALL
2	3	1	59S/H3BALL-2P
5	4	1	59S/H4BALL
2	4	1	59S/H4BALL-2P
5	5	1	59S/H5BALL
2	5	1	59S/H5BALL-2P
5	6	1	59S/H6BALL
2	6	1	59S/H6BALL-2P
5	8	1	59S/H8BALL
2	8	1	59S/H8BALL-2P
3	5,6,8	1	59S/HBALL-3P

Bolsa 2 Puntas combi para terminales (boca recta/Phillips), 125mm



59S/PH COMBI

2	5.0/PH1	1	59S/PH1COMBI-2P
2	6.0/PH2	1	59S/PH2COMBI-2P
2	8.0/PH3	1	59S/PH3COMBI-2P

Punta estándar Pozidriv - 125 mm



59S/125PZ

5	1	1	59S/125PZ1
2	1	25	59S/125PZ1-2P
5	2	1	59S/125PZ2
2	2	25	59S/125PZ2-2P
5	3	1	59S/125PZ3
2	3	25	59S/125PZ3-2P

Punta estándar Torx - 150 mm



59S/150T

5	T15	1	59S/150T15
2	T15	1	59S/150T15-2P
5	T20	1	59S/150T20
2	T20	1	59S/150T20-2P
5	T25	1	59S/150T25
2	T25	1	59S/150T25-2P
5	T30	1	59S/150T30
2	T30	1	59S/150T30-2P

Puntas para tornillos Phillips 5/32"



45S/PH

5	1	1	45S/PH1
2	1	50	45S/PH1-2P
5	2	1	45S/PH2
2	2	50	45S/PH2-2P

Puntas para tornillos hexagonales 5/32"



45S/H

5	1.5	1	45S/H1.5
2	1.5	50	45S/H1.5-2P
5	2	1	45S/H2
2	2	50	45S/H2-2P
5	2.5	1	45S/H2.5
2	2.5	50	45S/H2.5-2P
5	3	1	45S/H3
2	3	50	45S/H3-2P

Juego de 6 puntas Phillips, Pozidriv, TORX® y adaptador magnético



59S/7-1

7	22 x 65 x 75 mm	1 59S/7-1

59S/PH1, 59S/PH2		
59S/PZ1, 59S/PZ2		
59S/T15, 59S/T20		



Juego de 6 puntas Phillips, TORX® y adaptador magnético



59S/7-2



7	22 x 65 x 75 mm	1 59S/7-2

59S/PH2		
2x 59S/T15, 2x 59S/T20, 59S/T25		

Juego de 6 puntas TORX® Inviolable y adaptador magnético



59S/7-3



7	22 x 65 x 75 mm	1 59S/7-3

59S/TR10, 59S/TR15, 59S/TR20, 59S/TR25, 59S/TR30, 59S/TR40		
--	--	--

Juego de 6 puntas TORX® y adaptador magnético



59S/7-4



7	22 x 65 x 75 mm	1 59S/7-4

59S/T10, 59S/T15, 59S/T20, 59S/T25, 59S/T30, 59S/T40		
--	--	--

Juego de 16 puntas rectas, Phillips, Pozidriv Hexagonales y adaptador magnético



59S/17-1



17	27 x 73 x 82 mm	1 59S/17-1

59S/0.5-3.0, 59S/0.6-4.5, 59S/0.8-5.5		
59S/PH1, 3x 59S/PH2		
2x 59S/PH2G		
59S/PZ1, 2x 59S/PZ2		
59S/H3, 59S/H4, 59S/H5, 59S/H6		

Juego de 16 puntas TORX® y adaptador magnético



59S/17-2



17	27 x 73 x 82 mm	1 59S/17-2

59S/T10, 2x 59S/T15, 3x 59S/T20, 3x 59S/T25, 59S/T27, 2x 59S/T30, 59S/T40, 59S/T7, 59S/T8, 59S/T9		
---	--	--

Juego de 16 puntas Pozidriv, Phillips y TORX® y adaptador magnético



59S/17-3



17	27 x 73 x 82 mm	1 59S/17-3

59S/PH1, 2x 59S/PH2		
59S/PZ1, 59S/PZ2, 59S/PZ3		
59S/T10, 59S/T15, 59S/T20, 59S/T25, 59S/T27, 59S/T30, 59S/T40		
59S/H3, 59S/H4, 59S/H5		

Juego de puntas de 21 puntas Boca recta, Phillips, Pozidriv, TORX® y adaptador para vasos 1/4"



59S/22-1



22	20 x 50 x 80 mm	12 59S/22-1

59S/0.5-3.0, 59S/0.6-4.5, 59S/0.8-5.5		
59S/PH1, 59S/PH2, 59S/PH3		
59S/PH2G		
59S/PZ1, 59S/PZ2, 59S/PZ3		
59S/T6, 59S/T8, 59S/T9, 59S/T10, 59S/T15, 59S/T20, 59S/T25, 59S/T27, 59S/T30, 59S/T40		
K6650-1/4		

Juego de 21 puntas Phillips, TORX, hexagonales, adaptador, y adaptador para vasos 1/4"



59S/22-2



22	20 x 50 x 80 mm	12 59S/22-2

3x 59S/PH2		
3x 59S/PH2G		
2x 59S/PZ2		
59S/T10, 4x 59S/T15, 3x 59S/T20, 2x 59S/T25		
59S/H2.5, 59S/H3		
K6650-1/4		

Juego de adaptador y 28 puntas, tornillos Ranurados PHILLIPS®, TORX®, hexag., Torq-Set y adaptador



59S/28

X	mm		
28	30 x 58 x 110 mm	1	59S/28-4

59S/0.6-4.5, 59S/1.2-6.5, 59S/1.2-8.0		
2x 59S/PH1, 2x 59S/PH2, 59S/PH3		
59S/T6, 59S/T15		
59S/H5/64, 59S/H3/32, 59S/H7/64, 59S/H1/8, 59S/H9/64, 59S/H5/32, 59S/H3/16, 59S/H7/32		
2x 59S/TS-4, 2x 59S/TS-6, 2x 59S/TS-8, 2x 59S/TS-10		
K6625-1/4		
KM653		

Juego de 30 puntas para tornillos ranurados, Phillips, Pozidriv, TORX® y hexagonales, porta puntas y adaptador de 1/4"



59S/31B

X	mm		
31	40.25 x 104.90 x 65.35 mm 280 x 375 x 210 mm	6	59S/31B
		12	59S/31B-IP

1P: Envase unitario colgador plástico

59S/0.6-4.5, 59S/1.0-5.5		
59S/PH1, 3x 59S/PH2, 59S/PH3		
2x 59S/PH2G		
59S/PZ1, 3x 59S/PZ2, 59S/PZ3		
59S/T10, 3x 59S/T15, 3x 59S/T20, 2x 59S/T25, 59S/T27, 59S/T30		
59S/H3, 59S/H4, 59S/H5, 59S/H6		
K6625-1/4-1P		
KM653-QR-1P		

Juego de 30 puntas rectas, Phillips, Pozidriv TORX®, hexagonales y portapuntas magnético



59S/31-1

X	mm		
31	42 x 65 x 110 mm	12	59S/31-1

59S/0.5-3.0, 59S/0.6-4.5, 59S/0.8-5.5		
59S/PH1, 3x 59S/PH2, 59S/PH3		
2x 59S/PH2G		
59S/PZ1, 3x 59S/PZ2, 59S/PZ3		
59S/T10, 3x 59S/T15, 3x 59S/T20, 2x 59S/T25, 59S/T27, 59S/T30		
59S/H3, 59S/H4, 59S/H5, 59S/H6		
KM653-QR		

Juego de 30 puntas Phillips, Pozidriv, TORX® y Portapuntas magnético



59S/31-2

X	mm		
31	42 x 65 x 110 mm	1	59S/31-2

4x 59S/PH2		
4x 59S/PH2G		
4x 59S/PZ2		
2x 59S/T10, 4x 59S/T15, 5x 59S/T20, 5x 59S/T25, 2x 59S/T30		
KM653-QR		

Juego de 30 puntas Phillips, Pozidriv, TORX® inviolables y adaptador magnético



59S/31-3

X	mm		
31	42 x 65 x 110 mm	12	59S/31-3

2x 59S/PH1, 2x 59S/PH2, 59S/PH3		
2x 59S/PZ1, 2x 59S/PZ2, 59S/PZ3		
2x 59S/TR10, 3x 59S/TR15, 5x 59S/TR20, 4x 59S/TR25, 59S/TR27, 4x 59S/TR30, 59S/TR40		
KM653-QR		

Juego de puntas de 54 piezas para tornillos ranurados, Phillips, Pozidriv, TORX®, TORX® Tamper, Hexagonales y Robertson



59S/54BC

X	mm		
54	50 x 110 x 184 mm	1	59S/54BC

54	50 x 110 x 184 mm	1	59S/54BC
----	-------------------	---	----------



Juego de puntas de 54 piezas para tornillos ranurados, Phillips, Pozidriv, TORX®, TORX® Tamper, Hexagonales y Robertson



59/S54BC-IP

54	300 x 190 x 280 mm	8	59/S54BC-IP

Juego de puntas de 100 piezas para tornillos ranurados, Phillips, Pozidriv, TORX®, TORX® Tamper, Hexagon, Robertson



59/S100BC

100	50 x 110 x 184 mm	1	59/S100BC
100	300 x 190 x 280 mm	8	59/S100BC-IP

Juego de 18 puntas, 5 vasos, carraca para puntas y adaptadores



2058/S26

26	80 x 100 x 35 mm	30	2058/S26
26	80 x 100 x 35 mm	1	2058/S26-2
26	35 x 85 x 105 mm	1	SB-2058/S26

6700SM-8, 6700SM-7, 6700SM-6, 6700SM-5, 6700SM-4		
KM753-QR-1P		
K6625-1/4		
59S/0.5-3.0, 59S/0.8-5.5, 59S/0.5-4.0		
59S/T8, 59S/T7, 59S/T6, 59S/T5, 59S/T4		
59S/PZ1, 59S/PZ0, 59S/PZ2		
59S/H2, 59S/H2.5, 59S/H1.5, 59S/H3		
59S/PH0, 59S/PH1, 59S/PH2		

Punta Phillips con rosca



K18

1	2	5	K18NF-2
1	2	5	K18PH-2M5
1	2	5	K18PH-2M6

Punta Pozidriv con rosca

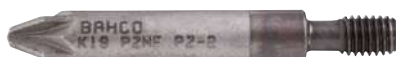

K19PZD-2NF

1	2	1	K19PZD-2NF
1	2	1	K19PZD-2M5

Punta TORX® con rosca



K20TORX

1	T25	10	K20TORX-T25

Punta de torsión TIN Phillips - 25 mm



62TIN/PH

10	1	1	62TIN/PH1
2	1	1	62TIN/PH1-2P
10	2	1	62TIN/PH2
2	2	1	62TIN/PH2-2P
10	3	1	62TIN/PH3
2	3	1	62TIN/PH3-2P

Punta de torsión TIN Pozidriv - 25 mm



62TIN/PZ

10	1	1	62TIN/PZ1
2	1	1	62TIN/PZ1-2P
10	2	1	62TIN/PZ2
2	2	1	62TIN/PZ2-2P
10	3	1	62TIN/PZ3
2	3	1	62TIN/PZ3-2P

Punta de torsión TIN Torx - 25 mm



62TIN/T

10	T10	1	62TIN/T10
2	T10	1	62TIN/T10-2P
10	T15	1	62TIN/T15
2	T15	1	62TIN/T15-2P
10	T20	1	62TIN/T20
2	T20	1	62TIN/T20-2P
10	T25	1	62TIN/T25
2	T25	1	62TIN/T25-2P
10	T30	1	62TIN/T30
2	T30	1	62TIN/T30-2P
10	T40	1	62TIN/T40
2	T40	1	62TIN/T40-2P

Punta de torsión TIN Phillips - 50 mm



62TIN/50PH

X	+		
5	1	1	62TIN/50PH1
2	1	1	62TIN/50PH1-2P
5	2	1	62TIN/50PH2
2	2	1	62TIN/50PH2-2P
5	3	1	62TIN/50PH3
2	3	1	62TIN/50PH3-2P

Punta de torsión TIN Pozidriv - 50 mm



62TIN/50PZ

X	+		
5	1	1	62TIN/50PZ1
2	1	1	62TIN/50PZ1-2P
5	2	1	62TIN/50PZ2
2	2	1	62TIN/50PZ2-2P
5	3	1	62TIN/50PZ3
2	3	1	62TIN/50PZ3-2P

Juego de 6 puntas TIN Phillips, Pozidriv, TORX® y adaptador



62TIN/7

X	mm		
7	22 x 65 x 75 mm	1	62TIN/7-1

62TIN/PH2	+	
62TIN/PZ2	+	
62TIN/T15, 62TIN/T20, 62TIN/T25, 62TIN/T30	+	

Punta de torsión Phillips - 25 mm



60T/PH

X	+		
10	1	1	60T/PH1
2	1	1	60T/PH1-2P
10	2	1	60T/PH2
2	2	1	60T/PH2-2P
10	3	1	60T/PH3
2	3	1	60T/PH3-2P

Punta de torsión Pozidriv - 25 mm



60T/PZ

X	+		
10	1	1	60T/PZ1
2	1	1	60T/PZ1-2P
10	2	1	60T/PZ2
2	2	1	60T/PZ2-2P
10	3	1	60T/PZ3
2	3	1	60T/PZ3-2P

Punta de torsión Torx - 25 mm



60T/T

X			
10	T7	1	60T/T7
10	T8	1	60T/T8
10	T9	1	60T/T9
10	T10	1	60T/T10
2	T10	1	60T/T10-2P
10	T15	1	60T/T15
2	T15	1	60T/T15-2P
10	T20	1	60T/T20
2	T20	1	60T/T20-2P
10	T25	1	60T/T25
2	T25	1	60T/T25-2P
10	T27	1	60T/T27
10	T30	1	60T/T30
2	T30	1	60T/T30-2P
10	T40	1	60T/T40
2	T40	1	60T/T40-2P

Juego de 6 puntas de torsión Phillips, Pozidriv, TORX® y adaptador magnético



60T/7

X	mm		
7	22 x 65 x 75 mm	1	60T/7-1

60T/PH2	+	
60T/PZ2	+	
60T/T10, 60T/T15, 60T/T20, 60T/T30	+	

Juego de 16 puntas de torsión Phillips, Pozidriv, TORX® y adaptador magnético



60T/17

X	mm		
17	27 x 73 x 82 mm	1	60T/17-1

60T/PH1, 60T/PH2	+	
60T/T10, 2x 60T/T15, 2x 60T/T20, 2x 60T/T25, 60T/T27, 2x 60T/T30, 60T/T40, 60T/T7, 60T/T8, 60T/T9	+	

Juego de puntas de impacto 31 piezas, Torx®, PH,PZ, Hex y portapuntas



60T/31

X	mm		
31	42 x 65 x 110 mm	12	60T/31-1

59S/0.6-4.5, 59S/0.8-5.5	+	
60T/PH1, 3x 60T/PH2, 60T/PH3	+	
2x 59S/PH2G	+	
60T/PZ1, 3x 60T/PZ2, 60T/PZ3	+	
60T/T10, 3x 60T/T15, 3x 60T/T20, 2x 60T/T25, 60T/T27, 2x 60T/T30	+	
59S/H3, 59S/H4, 59S/H5, 59S/H6	+	



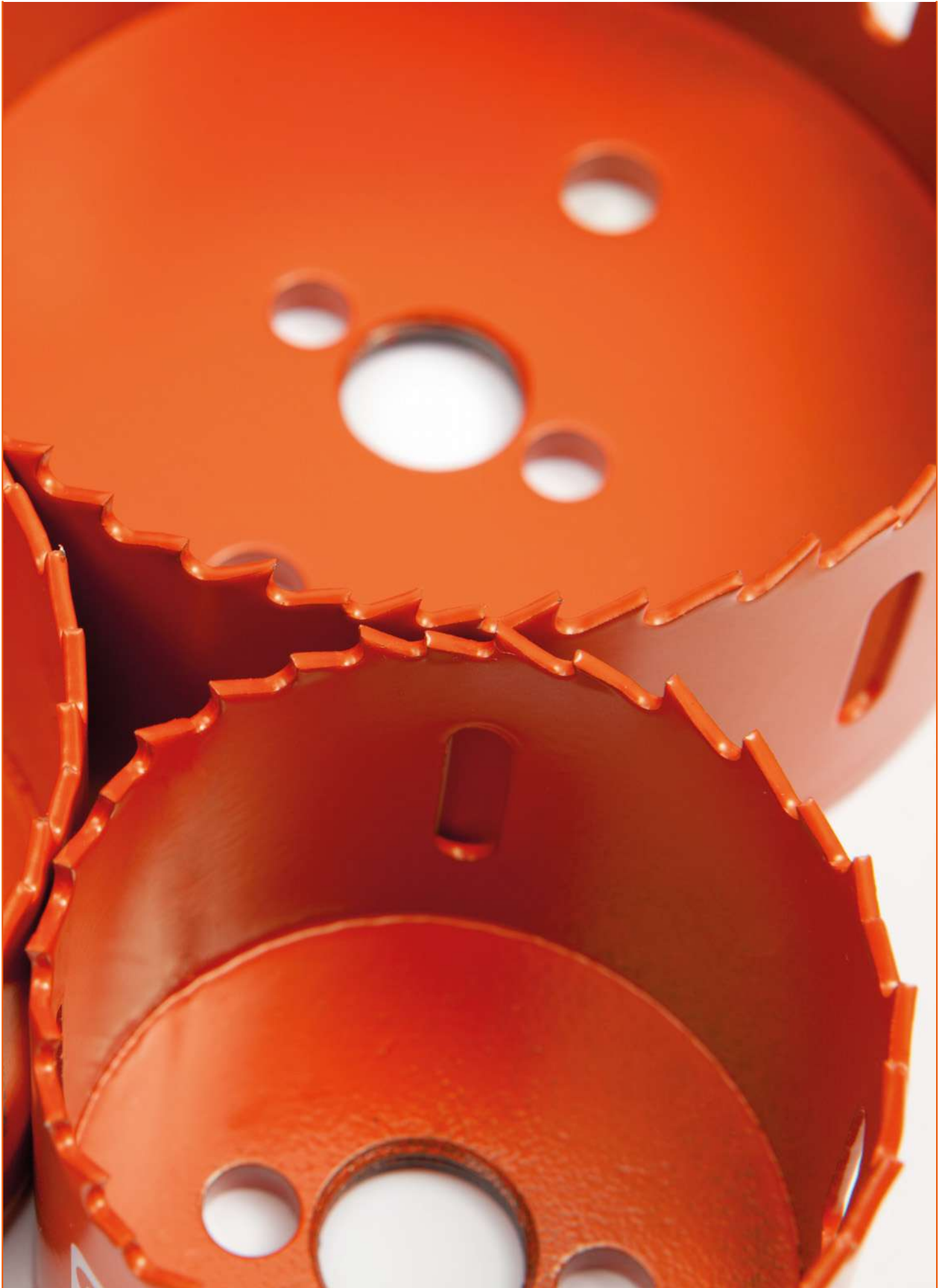

BAHCO



Destornilladores



DESTORNILLADORES ERGO™ CON MANGO DE GOMA ENCASTRADO Y CODIGO DE COLOR

Destornillador ERGO™
Para tornillos ranurados



BE-8010 - BE-8252

Ø	L	W	H	Icon	Icon
2.0	60	17	103	5	BE-8002
2.5	60	17	103	5	BE-8010
2.5	75	17	103	5	BE-8210
3.0	60	17	103	5	BE-8020
3.0	75	17	103	5	BE-8020L
3.0	100	17	103	5	BE-8022
3.0	125	17	103	5	BE-8220
3.0	200	17	103	5	BE-8225
3.5	75	17	103	5	BE-8030
3.5	125	17	103	5	BE-8230
3.5	200	17	103	5	BE-8235
4.0	100	20	122	5	BE-8040
4.0	175	20	122	5	BE-8240
5.5	125	27	122	5	BE-8241
5.5	150	27	122	5	BE-8242
5.5	200	27	122	5	BE-8250L
6.0	150	36	122	5	BE-8251
6.5	150	36	122	5	BE-8252

Destornillador ERGO™
Para tornillos ranurados



BE-8150 - BE-8258

Ø	L	W	H	Icon	Icon
5.5 mm	100	27	122	5	BE-8150
5.5 mm	150	27	122	5	BE-8250
6.5 mm	125	36	122	5	BE-8155
6.5 mm	150	36	122	5	BE-8255
8 mm	150	36	122	5	BE-8256
8 mm	175	36	122	5	BE-8257
10 mm	200	36	161	5	BE-8258

Destornillador ERGO™
Para tornillos ranurados, varilla hexagonal



BE-8158 - BE-8890

Ø	L	W	H	Icon	Icon
5.5	125	27	122	5	BE-8158
6.5	150	36	122	5	BE-8159
8	125	36	122	5	BE-8160
8	175	36	122	5	BE-8260
8	175	36	161	5	BE-8865
10	175	36	161	5	BE-8870
12	200	36	161	5	BE-8880
14	200	36	161	5	BE-8890

Destornillador ERGO™
Para tornillos ranurados, Extra-corto



BE-8330 - BE-8455

Ø	L	W	H	Icon	Icon
3.5	25	36	58	5	BE-8330
4.0	25	36	58	5	BE-8340
5.5	25	36	58	5	BE-8350
5.5	45	36	58	5	BE-8450
6.5	25	36	58	5	BE-8355
6.5	45	36	58	5	BE-8455
8.0	25	36	58	5	BE-8360

Destornillador ERGO™
Para tornillos PHILLIPS



BE-8600 - BE-8624

Icon	L	W	H	Icon	Icon
PH 0	60	17	103	5	BE-8600
PH 0	100	17	103	5	BE-8605
PH 0	200	17	103	5	BE-8608
PH 1	75	27	122	5	BE-8610
PH 1	75	20	122	5	BE-8611

PH 1		* 200	27	122	5	BE-8610L
PH 2		100	36	122	5	BE-8620
PH 2		100	27	122	5	BE-8621
PH 2		150	36	122	5	BE-8622
PH 2		* 200	36	122	5	BE-8620L
PH 3		150	36	122	5	BE-8623
PH 4		200	36	161	5	BE-8624

Destornillador ERGO™
Para tornillos PHILLIPS®, varilla hexagonal

ergo®



BE-8628 - BE-8640

PH 1		100	27	122	5	BE-8628
PH 2		125	36	122	5	BE-8629
PH 3		150	36	122	5	BE-8630
PH 4		200	36	161	5	BE-8640

Destornillador ERGO™
Para tornillos PHILLIPS®, Extra-corto

ergo®



BE-8601/BE-8602

PH 1		25	36	58	5	BE-8601
PH 2		25	36	58	5	BE-8602

Destornillador ERGO™
Para tornillos POZIDRIV

ergo®



BE-8800 - BE-8824

PZ 0		60	17	103	5	BE-8800
PZ 1		75	27	122	5	BE-8810
PZ 1		75	20	122	5	BE-8811
PZ 1		200	27	122	5	BE-8810L
PZ 2		100	36	122	5	BE-8820

PZ 2		100	27	122	5	BE-8821
PZ 2		200	36	122	5	BE-8820L
PZ 3		150	36	122	5	BE-8823
PZ 4		200	36	161	5	BE-8824

Destornillador ERGO™
Para tornillos Pozidriv, varilla hexagonal

ergo®



BE-8828 - BE-8840

PZ 1		100	27	122	5	BE-8828
PZ 2		125	36	122	5	BE-8829
PZ 3		150	36	122	5	BE-8830
PZ 4		200	36	161	5	BE-8840

Destornillador ERGO™
Para tornillos Pozidriv, Extra-corto

ergo®



BE-8801/BE-8802

PZ 1		25	36	58	5	BE-8801
PZ 2		25	36	58	5	BE-8802

Destornillador ERGO™ TORX® bola
Para tornillos TORX® bola

ergo®



BE-7515 - BE-7540

T 15		100	27	122	5	BE-7515
T 20		100	27	122	5	BE-7520
T 25		125	27	122	5	BE-7525
T 27		125	27	122	5	BE-7527
T 30		150	36	122	5	BE-7530
T 40		150	36	122	5	BE-7540



Destornillador ERGO™
Para tornillos TORX® Plus



BE-7715 - BE-7740



T 15	100	27	122	5	BE-7715
T 20	100	27	122	5	BE-7720
T 25	125	27	122	5	BE-7725
T 27	125	27	122	5	BE-7727
T 30	150	36	122	5	BE-7730
T 40	150	36	122	5	BE-7740

Destornillador ERGO™
Para tornillos TORX®



BE-8904 - BE-8945

T 4	75	17	103	5	BE-8904
T 5	75	17	103	5	BE-8905
T 6	75	17	103	5	BE-8906
T 7	75	17	103	5	BE-8907
T 8	75	17	103	5	BE-8908
T 9	75	17	103	5	BE-8909
T 10	75	20	122	5	BE-8910
T 15	100	27	122	5	BE-8915
T 20	100	27	122	5	BE-8920
T 25	125	27	122	5	BE-8925
T 27	125	27	122	5	BE-8927
T 30	150	36	122	5	BE-8930
T 40	150	36	161	5	BE-8940
T 45	150	36	161	5	BE-8945

Destornillador ERGO™
Para tornillos TORX® inviolables



BE-7907 - BE-7940

TR 7	75	17	103	5	BE-7907
TR 8	75	17	103	5	BE-7908
TR 9	75	17	103	5	BE-7909
TR 10	75	20	122	5	BE-7910
TR 15	100	27	122	5	BE-7915
TR 20	100	27	122	5	BE-7920
TR 25	125	27	122	5	BE-7925
TR 27	125	27	122	5	BE-7927

TR 30	150	36	122	5	BE-7930
TR 40	150	36	161	5	BE-7940

Destornillador ERGO™ hexagonal con bola, pulgadas
Para tornillos hexagonales en pulgadas



BE-8700-7/64 - BE-8700-5/16

7/64"	100	20	122	5	BE-8700-7/64
5/32"	100	27	122	5	BE-8700-5/32
3/16"	100	27	122	5	BE-8700-3/16
7/32"	100	36	122	5	BE-8700-7/32
1/4"	125	36	122	5	BE-8700-1/4
3/8"	150	36	161	5	BE-8700-3/8
5/16"	150	36	122	5	BE-8700-5/16

Destornillador ERGO™ hexagonal
Para tornillos hexagonales en métrica



BE-8702 - BE-8710

1.5	60	17	103	5	BE-8715
2	100	17	103	5	BE-8702
2.5	100	17	103	5	BE-8725
3	100	20	122	5	BE-8703
4	100	27	122	5	BE-8704
5	100	36	122	5	BE-8705
6	125	36	122	5	BE-8706
8	150	36	122	5	BE-8708
10	150	36	161	5	BE-8710

Destornillador ERGO™
Para tornillos hexagonales



BE-6902 - BE-6903

2	75	17	103	5	BE-6902
2.5	75	17	103	5	BE-6925
3	75	20	122	5	BE-6903

Destornillador ERGO™
Para tornillos Torq-set®



BE-8080

1		75	27	122	5	BE-8080-1
2		75	27	122	5	BE-8080-2
3		75	27	122	5	BE-8080-3
4		75	27	122	5	BE-8080-4
5		75	27	122	5	BE-8080-5
6		75	27	122	5	BE-8080-6
8		100	27	122	5	BE-8080-8
10		100	27	122	5	BE-8080-10

Mango ERGO™, puntero



BE-8980

6		100	27	122	5	BE-8980

Mango ERGO™, puntero



BE-8985

6		100	27	122	5	BE-8985

Punzón ERGO™
Mango de carrocer.



BE-8986

6		36	50	58	5	BE-8986

Destornillador ERGO™
Para tornillos Robertson (cuadrado)



BE-9001 - BE-9003

# 1		80	27	122	5	BE-9001
# 2		80	27	122	5	BE-9002
# 3		100	27	122	5	BE-9003

Destornillador ERGO™ para tornillos TRI-WING®
Para tornillos TRI-WING®



BE-9100 - BE-9105

0		80	20	122	5	BE-9100
1		80	20	122	5	BE-9101
2		80	27	122	5	BE-9102
3		80	27	122	5	BE-9103
4		100	27	122	5	BE-9104
5		100	27	122	5	BE-9105



Juego destornillador con 6 varillas intercambiables ERGO™
2 planas, 2 Phillips, 2 Pozi

ergo®



BE-8571



7	85 x 85 x 210 mm	1	BE-8571

BE-8575		
8242-2P, 8252-2P		
8610-2P, 8620-2P		
8810-2P, 8820-2P		

Mango destornillador multivarilla hexágono 1/4"

ergo®



BE-8575



1/4"	122	1	BE-8575

Portapuntas ERGO™ hexágono hembra 1/4"

ergo®



BE-8577



1/4	118	36	122	5	BE-8577

Juego destornillador con 8 varillas intercambiables ERGO™
2 planas, 2 Phillips, 2 Pozidriv, y 2 Torx®

ergo®



BE-8572



9	85 x 80 x 210 mm	1	BE-8572

BE-8575		
8242-2P, 8252-2P		
8610-2P, 8620-2P		
8810-2P, 8820-2P		
8910-2P, 8915-2P		

Juego destornillador con 7 varillas intercambiables TORX®
ERGO™
Para TORX®

ergo®



BE-8573



8	85 x 85 x 210 mm	1	BE-8573

BE-8575		
8910-2P, 8915-2P, 8920-2P, 8925-2P, 8927-2P, 8930-2P, 8940-2P		

Juego destornilladores ERGO™ con varillas intercambiables, 7 piezas
Para tornillos Phillips, Pozidriv y TORX®



BE-8574



8	85 x 85 x 210 mm	1	BE-8574

BE-8575		
8610-2P, 8620-2P		
8040-2P		
8820-2P		
8920-2P, 8925-2P, 8930-2P		

Foam con 22 piezas con mango intercambiable, 16 varillas y 6 puntas ERGO™
Para tornillos planos, Phillips, Pozidriv, TORX® y punta hexagonal



BE-8576

23		1 BE-8576

BE-8575		
8030-2P, 8040-2P, 8242-2P, 8252-2P		
8810-2P, 8820-2P, 8830-2P		
8610-2P, 8620-2P, 8630-2P		
8910-2P, 8915-2P, 8925-2P, 8930-2P, 8940-2P		
59S/H2, 59S/H3, 59S/H4, 59S/H5, 59S/H6, 59S/H8		

Destornillador stecker ERGO™



BE-6400M

4	100	20	122	5	BE-6400M-4
5	100	20	122	5	BE-6400M-5
5.5	100	20	122	5	BE-6400M-5.5
7	100	20	122	5	BE-6400M-7

Destornillador stecker ERGO™, varilla flexible



BE-76

6	150	27	122	5	BE-7606
7	150	27	122	5	BE-7607
8	150	27	122	5	BE-7608

Destornillador stecker ERGO™, con boca larga



BE-78

3	125	20	122	5	BE-7803
3.5	125	20	122	5	BE-7835
4	125	20	122	5	BE-7804
4.5	125	20	122	5	BE-7845
5	125	20	122	5	BE-7805
5.5	125	20	122	5	BE-7855
6	125	20	122	5	BE-7806
7	125	27	122	5	BE-7807
8	125	27	122	5	BE-7808
9	125	36	122	5	BE-7809
10	125	36	122	5	BE-7810
11	125	36	122	5	BE-7811
12	125	36	122	5	BE-7812
13	125	36	161	5	BE-7813
14	125	36	161	5	BE-7814



Juego 5 destornilladores ERGO™
Para tornillos TORX®



BE-9885



5

1 BE-9885

BE-8910, BE-8915, BE-8920, BE-8925, BE-8930



Juego 6 destornilladores ERGO™
Para tornillos ranurados y Phillips



BE-9881



6

1 BE-9881

BE-8020, BE-8040



BE-8150, BE-8155



BE-8610, BE-8620



Juego 6 destornilladores ERGO™
Para tornillos ranurados y Pozidriv



BE-9882



6

1 BE-9882



BE-8020, BE-8040



BE-8155, BE-8150



BE-8810, BE-8820



Juego 6 destornilladores aislados ERGO™
Bocas rectas, PH y PZ



BE-9884



6

1 BE-9884

BE-8611, BE-8621



BE-8040, BE-8241



BE-8811, BE-8821



Juego 6 destornilladores ERGO™
Para tornillos ranurados, Phillips y Pozidriv



BE-9886



6

1 BE-9886

BE-8030



BE-8150



BE-8621, BE-8611



BE-8811, BE-8821



Juego 6 destornilladores ERGO™
Plano, Phillips, Pozidriv, TORX®



BE-9871

6 1 BE-9871

BE-8220S		
BE-8920, BE-8925		
BE-8820		
BE-8611, BE-8620		

Juego 13 destornilladores ERGO™
Para tornillos ranurados, Phillips, Pozidriv y TORX®



BE-9875

13 1 BE-9875

BE-8040		
BE-8150, BE-8155		
BE-8621		
BE-8811, BE-8821		
BE-8910, BE-8915, BE-8920, BE-8925		
BE-8010S, BE-8230S		
BE-8810S		

Juego 15 destornilladores ERGO™
Para tornillos ranurados, Phillips; Pozidriv y TORX®



BE-9877

15 1 BE-9877

BE-8030		
BE-8150		
BE-8611, BE-8621		
BE-8811, BE-8821		
BE-8910, BE-8915, BE-8920, BE-8925		
BE-8220S, BE-8040S, BE-8050S		
BE-8610S, BE-8620S		

Juego destornilladores ERGO™ aislados, 14 piezas
Para tornillos ranurados, Phillips, Pozidriv, TORX® y Combi PZ



BE-9876S

14 1 BE-9876S

BE-8010S, BE-8220S, BE-8230S, BE-8040S, BE-8050S		
BE-8610S, BE-8620S		
BE-8810S, BE-8820S		
BE-8910S, BE-8915S, BE-8920S		
BE-8710S, BE-8720S		



DESTORNILLADORES BAHCOFIT CON MANGO DE GOMA ESTRIADA

Destornillador Boca Plana BahcoFit



B190

Tip	Length	Shaft Dia	Tip Dia	Tip Length	Quantity	Part No.
4 mm	75	24.5	95		10	B190.040.075
4 mm	100	24.5	95		10	B190.040.100
5.5 mm	100	30	105		10	B190.055.100
5.5 mm	125	30	105		10	B190.055.125
6.5 mm	125	34	117		10	B190.065.125
6.5 mm	150	34	117		10	B190.065.150
8 mm	150	34	117		10	B190.080.150
8 mm	175	34	117		10	B190.080.175
10 mm	200	34	117		10	B190.100.200
12 mm	250	34	117		10	B190.120.250
14 mm	250	34	117		10	B190.140.250
4 mm	75	24.5	95		1	SB190.040.075
4 mm	100	24.5	95		1	SB190.040.100
5.5 mm	100	30	105		1	SB190.055.100
5.5 mm	125	30	105		1	SB190.055.125
6.5 mm	125	34	117		1	SB190.065.125
6.5 mm	150	34	117		1	SB190.065.150
8 mm	150	34	117		1	SB190.080.150
8 mm	175	34	117		1	SB190.080.175
10 mm	200	34	117		1	SB190.100.200
12 mm	250	34	117		1	SB190.120.250
14 mm	250	34	117		1	SB190.140.250

SB: Presentación en clip

Destornillador Boca Recta BahcoFit



B191

Tip	Length	Shaft Dia	Tip Dia	Tip Length	Quantity	Part No.
2.5 mm	75	24.5	95		10	B191.025.075
3 mm	75	24.5	95		10	B191.030.075
3 mm	100	24.5	95		10	B191.030.100
3 mm	200	24.5	95		10	B191.030.200
3.5 mm	100	24.5	95		10	B191.035.100
4 mm	100	24.5	95		10	B191.040.100
4 mm	125	24.5	95		10	B191.040.125
4 mm	250	24.5	95		10	B191.040.250
5.5 mm	125	30	105		10	B191.055.125
5.5 mm	150	30	105		10	B191.055.150
5.5 mm	300	30	105		10	B191.055.300

BAHCO

Tip	Length	Shaft Dia	Tip Dia	Tip Length	Quantity	Part No.
6.5 mm	150	34	117		10	B191.065.150
6.5 mm	300	34	117		10	B191.065.300
2.5 mm	75	24.5	95		1	SB191.025.075
3 mm	75	24.5	95		1	SB191.030.075
3 mm	100	24.5	95		1	SB191.030.100
3 mm	200	24.5	95		1	SB191.030.200
3.5 mm	100	24.5	95		1	SB191.035.100
4 mm	100	24.5	95		1	SB191.040.100
4 mm	125	24.5	95		1	SB191.040.125
4 mm	250	24.5	95		1	SB191.040.250
5.5 mm	125	30	105		1	SB191.055.125
5.5 mm	150	30	105		1	SB191.055.150
5.5 mm	300	30	105		1	SB191.055.300
6.5 mm	150	34	117		1	SB191.065.150
6.5 mm	300	34	117		1	SB191.065.300

SB: Presentación en clip

Destornillador BahcoFit boca plana carrocerero Boca plana y boca recta



B195

Tip	Length	Shaft Dia	Tip Dia	Tip Length	Quantity	Part No.
4	25	33	60		10	B195.040.025
5.0	25	33	60		10	B195.050.025
6	25	33	60		10	B195.060.025
4	25	33	60		1	SB195.040.025
5	25	33	60		1	SB195.050.025
6	25	33	60		1	SB195.060.025







SB: Presentación en clip

Destornillador Boca Phillips BahcoFit



B192

Tip	Length	Shaft Dia	Tip Dia	Tip Length	Quantity	Part No.
PH0	75	24.5	95		10	B192.000.075
PH0	200	24.5	95		10	B192.000.200
PH1	100	30	105		10	B192.001.100
PH1	250	30	105		10	B192.001.250
PH2	125	34	117		10	B192.002.125
PH2	300	34	117		10	B192.002.300
PH3	150	34	117		10	B192.003.150
PH4	200	34	117		10	B192.004.200







						
PH0	75	24.5	95	1	SB192.000.075	
PH0	200	24.5	95	1	SB192.000.200	
PH1	100	30	105	1	SB192.001.100	
PH1	250	30	105	1	SB192.001.250	
PH2	125	34	117	1	SB192.002.125	
PH2	300	34	117	1	SB192.002.300	
PH3	150	34	117	1	SB192.003.150	
PH4	200	34	117	1	SB192.004.200	

SB: Presentación en clip

Destornillador PH Mango Carrocero



B195PH







						
PH1	25	33	60	10	B195.001.025	
PH2	25	33	60	10	B195.002.025	
PH1	25	33	60	1	SB195.001.025	
PH2	25	33	60	1	SB195.002.025	

SB: Presentación en clip

Destornillador Boca Pozidriv BahcoFit



B193







						
PZ0	75	24.5	95	10	B193.000.075	
PZ1	100	30	105	10	B193.001.100	
PZ2	125	34	117	10	B193.002.125	
PZ3	150	34	117	10	B193.003.150	
PZ4	200	34	117	10	B193.004.200	
PZ0	75	24.5	95	1	SB193.000.075	
PZ1	100	30	105	1	SB193.001.100	
PZ2	125	34	117	1	SB193.002.125	
PZ3	150	34	117	1	SB193.003.150	
PZ4	200	34	117	1	SB193.004.200	

SB: Presentación en clip

Destornillador BahcoFit PZ, carrocero



B195PZ







						
PZ1	25	33	60	10	B195.901.025	
PZ2	25	33	60	10	B195.902.025	
PZ1	25	33	60	1	SB195.901.025	
PZ2	25	33	60	1	SB195.902.025	

SB: Presentación en clip

Destornillador Boca Torx BahcoFit



B194

						
T4	75	24.5	95	10	B194.004.075	
T5	75	24.5	95	10	B194.005.075	
T6	75	24.5	95	10	B194.006.075	
T7	75	24.5	95	10	B194.007.075	
T8	75	24.5	95	10	B194.008.075	
T9	75	24.5	95	10	B194.009.075	
T10	75	24.5	95	10	B194.010.075	
T15	100	24.5	95	10	B194.015.100	
T20	100	24.5	95	10	B194.020.100	
T25	125	30	105	10	B194.025.125	
T27	125	30	105	10	B194.027.125	
T30	150	34	117	10	B194.030.150	
T40	150	34	117	10	B194.040.150	
T45	150	34	117	5	B194.045.150	
T4	75	24.5	95	1	SB194.004.075	
T5	75	24.5	95	1	SB194.005.075	
T6	75	24.5	95	1	SB194.006.075	
T7	75	24.5	95	1	SB194.007.075	
T8	75	24.5	95	1	SB194.008.075	
T9	75	24.5	95	1	SB194.009.075	
T10	75	24.5	95	1	SB194.010.075	
T15	100	24.5	95	1	SB194.015.100	
T20	100	24.5	95	1	SB194.020.100	
T25	125	30	105	1	SB194.025.125	
T27	125	30	105	1	SB194.027.125	
T30	150	34	117	1	SB194.030.150	
T40	150	34	117	1	SB194.040.150	
T45	150	34	117	1	SB194.045.150	

SB: Presentación en clip



Destornillador Torx Inviolable BahcoFit



B141



TR7	75	24.5		5	B141.007.075
TR8	75	24.5		5	B141.008.075
TR9	75	24.5		5	B141.009.075
TR10	75	24.5		5	B141.010.075
TR15	100	24.5		5	B141.015.100
TR20	100	24.5		5	B141.020.100
TR25	125	30		5	B141.025.125
TR27	125	30		5	B141.027.125
TR30	150	34		5	B141.030.150
TR40	150	34		5	B141.040.150
TR7	75	24.5		1	SB141.007.075
TR8	75	24.5		1	SB141.008.075
TR9	75	24.5		1	SB141.009.075
TR10	75	24.5		1	SB141.010.075
TR15	100	24.5		1	SB141.015.100
TR20	100	24.5		1	SB141.020.100
TR25	125	30		1	SB141.025.125
TR27	125	30		1	SB141.027.125
TR30	150	34		1	SB141.030.150
TR40	150	34		1	SB141.040.150

SB: Presentación en clip

Destornillador Hexagonal Bola BahcoFit



B143



2	100	24.5	95	5	B143.020.100
2.5	100	24.5	95	10	B143.025.100
3	100	24.5	95	10	B143.030.100
4	100	24.5	95	10	B143.040.100
5	100	30	105	10	B143.050.100
6	125	34	117	10	B143.060.125
8	150	34	117	5	B143.080.150
2	100	24.5	95	1	SB143.020.100
2.5	100	24.5	95	1	SB143.025.100
3	100	24.5	95	1	SB143.030.100
4	100	24.5	95	1	SB143.040.100
5	100	30	105	1	SB143.050.100
6	125	34	117	1	SB143.060.125
8	150	34	117	1	SB143.080.150

SB: Presentación en clip

Destornillador BahcoFit boca Robertson



B144



#1	100	24.5	95	5	B144.001.100
#2	125	30	105	5	B144.002.125
#3	150	34	117	5	B144.003.150
#1	100	24.5	95	1	SB144.001.100
#2	125	30	105	1	SB144.002.125
#3	150	34	117	1	SB144.003.150

SB: Presentación en clip

Destornillador Puntero boca redonda BahcoFit



B145



6	100	30	105	5	B145.006.100
6	100	30	105	1	SB145.006.100

SB: Presentación en clip

Destornillador BahcoFit Puntero boca cuadrada



B146



6	100	30	105	5	B146.006.100
6	100	30	105	1	SB146.006.100

SB: Presentación en clip

Punzón carrocerero
Para marcado y fijado de agujeros



B195Awl

Ø	L	l	Ø	Icon	Icon
6	50	33	60	5	B195.006.050
6 mm	50	33	60	1	SB195.006.050

SB: Presentación en clip

Destornillador Stecker BahcoFit



B198

Ø	L	l	Ø	Icon	Icon
4	125	24.5	95	5	B198.040.125
4.5	125	24.5	95	5	B198.045.125
5	150	30	105	5	B198.050.150
5.5	150	30	105	5	B198.055.150
6	150	30	105	5	B198.060.150
6	150	34	117	5	B198.060.150F
7	150	34	117	5	B198.070.150
7	150	34	117	5	B198.070.150F
8	150	34	117	5	B198.080.150
8	150	34	117	5	B198.080.150F
9	150	34	117	5	B198.090.150
10	150	34	117	5	B198.100.150
11	150	34	117	5	B198.110.150
12	150	34	117	5	B198.120.150
13	150	34	117	5	B198.130.150
14	150	34	117	5	B198.140.150
4	125	24.5	95	1	SB198.040.125
4.5	125	24.5	95	1	SB198.045.125
5	150	30	105	1	SB198.050.150
5.5	150	30	105	1	SB198.055.150
6	150	30	105	1	SB198.060.150
6	150	34	117	1	SB198.060.150F
7	150	34	117	1	SB198.070.150
7	150	34	117	1	SB198.070.150F
8	150	34	117	1	SB198.080.150
8	150	34	117	1	SB198.080.150F
9	150	34	117	1	SB198.090.150
10	150	34	117	1	SB198.100.150
11	150	34	117	1	SB198.110.150
12	150	34	117	1	SB198.120.150
13	150	34	117	1	SB198.130.150
14	150	34	117	1	SB198.140.150

SB: Presentación en clip

Destornillador Stecker Magnético Flexible



B147

Ø	L	l	Icon	Icon
10	400	30	1	B147.001.400
13	400	34	1	B147.003.400
10	400	30	1	SB147.001.400
18	390	34	1	SB147.003.400

SB: Presentación en clip

Juego 2 destornilladores BahcoFit
Para tornillos planos y Phillips



B219.002

Icon	Icon	Icon
2	1	B219.002

B191.040.100

B192.001.100

Juego 2 destornilladores BahcoFit
Para tornillos ranurados y Phillips



B219.012

Icon	Icon	Icon
2	1	B219.012

B190.055.125

B192.002.125



Juego 4 destornilladores BahcoFit PL/PH
Para tornillos ranurados y Phillips



B219.004



4

1 B219.004

B191.030.100, B191.055.125



B192.001.100, B192.002.125



Juego 5 destornilladores BahcoFit PL/RECTA/PH
Para tornillos ranurados y Phillips



B219.005



5

1 B219.005

B191.030.075, B191.040.100



B190.055.125



B192.001.100, B192.002.125



Juego 5 destornilladores BahcoFit PL/RECTA/PZ
Para tornillos ranurados y Pozidriv



B219.015



5

1 B219.015

B191.030.075, B191.040.100



B190.055.125



B193.001.100, B193.002.125



Juego 5 destornilladores BahcoFit TORX
Para TORX®



B219.025



5

1 B219.025

B194.010.075, B194.015.100, B194.020.100, B194.025.125,
B194.030.150



Juego 5 destornilladores BahcoFit TORX® INVOLABLE
Para TORX® Tamper resistant



B219.035



5

1 B219.035

B141.010.075, B141.015.100, B141.020.100, B141.025.125,
B141.030.150



Juego 6 destornilladores BahcoFit PL/RECTA/PH
Para tornillos ranurados y Phillips



B219.006



6

1 B219.006

B191.030.075, B191.040.100



B190.055.125, B190.065.125



B192.001.100, B192.002.125



Juego 6 destornilladores BahcoFit PL/RECTA/PZ
Para tornillos ranurados y Pozidriv



B219.016



6

1 B219.016

B191.030.075, B191.040.100



B190.055.125, B190.065.125



B193.001.100, B193.002.125



Juego 6 destornilladores BahcoFit RECTA/PH/PZ
Para tornillos ranurados, Phillips y Pozidriv



B219.026



6

1 B219.026

B191.030.075, B191.040.100



B192.001.100, B192.002.125



B193.001.100, B193.002.125



Juego 7 destornilladores BahcoFit POZI/TORX
Para Pozidriv y TORX®



B219.007



7

1 B219.007

B193.001.100, B193.002.125



B194.010.075, B194.015.100, B194.020.100, B194.025.125,
B194.030.150



Juego 7 destornilladores BahcoFit PLANA/RECTA/PH
Para tornillos ranurados y Phillips



B219.017



7

1 B219.017

B191.035.100, B191.040.100



B190.055.125, B190.065.150, B190.080.150



B192.001.100, B192.002.125



Juego 7 destornilladores Bahcofit
Para tornillos TORX®



B219.027



7

1 B219.027

B194.010.075, B194.015.100, B194.020.100, B194.025.125,
B194.027.125, B194.030.150, B194.040.150



Juego 8 destornilladores BahcoFit PL/RECTA/PH/EXTRACORTO PH,PZ
Para tornillos ranurados y Phillips



B219.008



8

1 B219.008

B191.040.100, B191.055.125

B190.065.150, B190.080.175

B192.001.100, B192.002.125

B195.060.025

B195.002.025

Juego 10 destornilladores BahcoFit RECTA/PL/PH/PZ/
ROBERTSON
Para tornillos ranurados, Phillips, Pozidriv y Robertson



B219.010



10

1 B219.010

B191.030.075

B190.055.100, B190.065.125, B190.080.150

B192.001.100, B192.002.125, B192.003.150

B195.902.025

B144.001.100, B144.002.125

DESTORNILLADORES CON MANGO DE GOMA

Destornillador plano



611

Ø	L	l	l	Icon 1	Icon 2
3.5	75	25	80	10	611-3.5-75
3.5	100	25	80	10	611-3.5-100
4.0 mm	75 mm	25	80 mm	10	611-4-75
4.0	100	25	80	10	611-4-100
5.5	100	30	97	10	611-5.5-100
5.5	125	30	97	10	611-5.5-125
6.5	25	35	60	10	611-6.5-25
6.5	125	35	110	10	611-6.5-125
6.5	150	35	110	10	611-6.5-150
8.0	150	35	110	10	611-8-150
8.0	175	35	110	10	611-8-175
10.0	200	35	110	10	611-10-200

Destornillador punta recta



613

Ø	L	l	l	Icon 1	Icon 2
3.0	75	25	80	10	613-3-75
3.0	100	25	80	10	613-3-100
3.5	100	25	80	10	613-3.5-100
4.0	100	25	80	10	613-4-100
4.0	125	25	80	10	613-4-125
5.5	150	30	97	10	613-5.5-150
6.5	150	35	110	10	613-6.5-150

Destornillador Phillips



615

Icon	L	l	l	Icon 1	Icon 2
PH 0	75	25	80	10	615-0-75
PH 1	100	30	97	10	615-1-100
PH 2	25	35	60	10	615-2-25

PH 2	125	35	110	10	615-2-125
PH 3	150	35	110	10	615-3-150

Destornillador Pozidriv



616



PZ 0	75	25	80	10	616-0-75
PZ 1	100	30	97	10	616-1-100
PZ 2	125	35	110	10	616-2-125
PZ 3	150	35	110	10	616-3-150

Destornillador TORX®



618



T 10	75	25	80	10	618-10-75
T 15	100	25	80	10	618-15-100
T 20	100	25	80	10	618-20-100
T 25	125	30	97	10	618-25-125
T 27	125	30	97	10	618-27-125
T 30	150	35	110	10	618-30-150
T 40	150	35	110	10	618-40-150

Juego 3 destornilladores serie-600 Ranurado 3, 5.5 y PH 1



600-3



3	1	600-3

613-3-100		
611-5.5-125		
615-1-100		

Juego 4 destornilladores Serie 600 Plano 3, 5.5 y PH 1, PH 2



602-4-LA



4	1	602-4-LA

613-3-100		
611-5.5-100		
615-1-100, 615-2-125		

Juego 5 destornilladores serie-600 Ranurado 3, 4, 6.5 y PH 1, 2



604-5



5	1	604-5

613-3-100		
611-4-100, 611-6.5-125		
615-1-100, 615-2-125		

Juego 6 destornilladores Serie 600 Ranurado 3, 4, PH1, PH2, PZ1, PZ2



605-6



6	1	605-6

613-3-75, 613-4-100		
615-1-100, 615-2-125		
616-1-100, 616-2-125		



Juego 6 destornilladores Serie-600
Ranurado 3, 4, 5.5, 6.5 y PH 1, 2



606-6



6

1 606-6

611-5.5-100, 611-6.5-125



613-3-75, 613-4-100



615-1-100, 615-2-125



Juego 6 destornilladores Serie-600
Ranurado 3, 4, 5.5, 6.5 y PZ 1, 2



610-6



6

1 610-6

611-5.5-100, 611-6.5-125



613-3-75, 613-4-100



616-1-100, 616-2-125



Juego 5 destornilladores Serie 600
TORX® T10, T15, T20, T25, T30



612-5



5

1 612-5

618-10-75, 618-15-100, 618-20-100, 618-25-125, 618-30-150



Juego 6 destornilladores aislados Serie 600
Ranurado 3, 4, 5.5, 6.5 y PH 1, 2



620-6



6

1 620-6

623-4-100, 623-3-100, 623-5.5-125, 623-6.5-150



625-1-150, 625-2-175



Juego 6 destornilladores Serie 600
Plano 3, 4, PH1, PH2, PZ1, PZ2



605-6-PC



6

1 605-6-PC

613-3-75, 613-4-100



615-1-100, 615-2-125



616-1-100, 616-2-125



Juego 10 destornilladores Serie 600
Plano, Phillips y Robertson



605-10-PC-AU



10

1 605-10-PC-AU

611-5.5-100, 611-6.5-125, 611-8-150



613-3-75



615-1-100, 615-2-125, 615-3-150



DESTORNILLADORES CON MANGO DE IMPACTO

Destornillador varilla pasante
Para tornillos ranurados



9715



14.0	250	32	140	5	9715-14-250

Destornillador de varilla pasante ERGO™
Para tornillos planos, perfil hexagonal

ergo®



BE-8135TB - BE-8262TB

3.5 mm	75 mm	27	122 mm	10	BE-8135TB
4.5 mm	100 mm	27	122 mm	10	BE-8145TB
5.5 mm	100 mm	27	122 mm	10	BE-8150TB
6.5 mm	125 mm	36	122 mm	5	BE-8155TB
8 mm	150 mm	36	122 mm	5	BE-8256TB
10 mm	175 mm	36	122 mm	10	BE-8258TB
12 mm	200 mm	36	122 mm	10	BE-8262TB
3.5 mm	75 mm	27	122 mm	1	SBE-8135TB
9 mm	100 mm	27	122 mm	1	SBE-8145TB
5.5 mm	100 mm	27	122 mm	1	SBE-8150TB
6.5 mm	125 mm	36	122 mm	1	SBE-8155TB

SB: Presentación en clip

Destornillador ERGO™ varilla hexagonal, pasante
Para tornillos Phillips, perfil hexagonal

ergo®



BE-8610TB - BE-8624TB

PH 1	100 mm	27	122 mm	10	BE-8610TB
PH 2	125 mm	36	122 mm	10	BE-8620TB



PH 3	150 mm	36	122 mm	10	BE-8623TB
PH 4	175 mm	36	122 mm	10	BE-8624TB
PH 1	100 mm	27	122 mm	1	SBE-8610TB
PH 2	125 mm	36	122 mm	1	SBE-8620TB

SB: Presentación en clip

Destornillador ERGO™ varilla hexagonal, pasante
Para tornillos Pozidriv, perfil hexagonal

ergo®



BE-8810TB - BE-8824TB

PZ 1	100 mm	27	122 mm	10	BE-8810TB
PZ 2	125 mm	36	122 mm	10	BE-8820TB
PZ 3	150 mm	36	122 mm	10	BE-8823TB
PZ 4	175 mm	36	122 mm	10	BE-8824TB
PZ 1	100 mm	27	122 mm	1	SBE-8810TB
PZ 2	125 mm	36	122 mm	1	SBE-8820TB

Destornillador ERGO™ varilla hexagonal, pasante
Para tornillos Torx® perfil hexagonal

ergo®



BE-8910TB - BE-8940TB

T 10	75 mm	27	122 mm	5	BE-8910TB
T 15	100 mm	27	122 mm	5	BE-8915TB
T 20	100 mm	27	122 mm	5	BE-8920TB
T 25	100 mm	27	122 mm	5	BE-8925TB
T 27	125 mm	27	122 mm	5	BE-8927TB
T 30	150 mm	36	122 mm	5	BE-8930TB
T 40	150 mm	36	122 mm	5	BE-8940TB
T 15	100 mm	27	122 mm	1	SBE-8915TB
T 20	100 mm	27	122 mm	1	SBE-8920TB
T 25	100 mm	27	122 mm	1	SBE-8925TB
T 30	150 mm	36	122 mm	1	SBE-8930TB
T 40	150 mm	36	122 mm	1	SBE-8940TB

SB: Presentación en clip



Juego de 6 destornilladores de varilla pasante ERGO™
Para tornillos ranurados y Pozidriv, perfil hexagonal



BE-9882TB



6

1 BE-9882TB

BE-8135TB, BE-8145TB, BE-8150TB, BE-8155TB



BE-8810TB, BE-8820TB



Juego de 6 destornilladores de varilla pasante ERGO™
Para tornillos planos y PH, perfil hexagonal



BE-9881TB



6

1 BE-9881TB

BE-8135TB, BE-8145TB, BE-8150TB, BE-8155TB



BE-8610TB, BE-8620TB



Juego de 5 destornilladores ERGO™ varilla pasante
Para tornillos TORX®



BE-9885TB



5

1 BE-9885TB

BE-8915TB, BE-8920TB, BE-8925TB, BE-8930TB, BE-8940TB



DESTORNILLADORES CON MANGO DE CARRACA

Destornillador de carraca



808050



1/4"

125

41.6

123 mm

50

808050

Destornillador de carraca con lámpara LED
808050L-SP1: led de repuesto + 3 pilas AG-3, 4.5V



808050L



1/4

135

41.6

135 mm

25

808050L

1 808050L-SP1

Destornillador de carraca con mango en forma de pistola



808050P



1/4

135

40

125 mm

50

808050P

Juego destornillador con carraca de mango giratorio, 25 piezas



808050P-

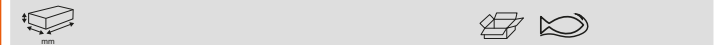

70 x 158 x 285 mm

10

808050P-25

Destornillador a carraca con mango en T extra corto



808050TS

1/4	68	91	63.5 mm	1	808050TS

Destornillador a carraca extra corto



808050S

1/4	68	41	69 mm	25	808050S

Juegos de destornillador a carraca extra corto de 18 y 22 piezas



808050S-



46 x 130 x 195 mm	30 808050S-18
46 x 130 x 195 mm	30 808050S-22

Pack 2 varillas hex 1/4" para tornillos planos, 100 mm



8020-2P - 8252-2P

3.0	0.5	1	8020-2P
3.5	0.6	1	8030-2P
4.0	0.8	1	8040-2P
5.5	1.0	1	8242-2P
6.5	1.2	1	8252-2P

Pack 2 varillas hex 1/4" para tornillos ranurados, 300mm



8040L-2P - 8252L-2P

0.8	4.0	1	8040L-2P
1.0	5.5	1	8242L-2P
1.2	6.5	1	8252L-2P

Varilla hexagonal 1/4" para tornillos de cabeza Phillips, 400mm



8620XL-1P - 8252XL-1P

2	1	8620XL-1P
3	1	8630XL-1P

Pack 2 varillas hex 1/4" para tornillos Philips, 100 mm



8600-2P - 8630-2P

0	1	8600-2P
1	1	8610-2P
2	1	8620-2P
3	1	8630-2P



Pack 2 varillas hex 1/4" para tornillos Philips, 300mm



8610L-2P - 8620L-2P



1	1	8610L-2P
2	1	8620L-2P

Varilla hexagonal 1/4" para tornillos de cabeza Pozidriv, 400mm



8820XL-1P - 8830XL-1P



2	1	8820XL-1P
3	1	8830XL-1P

Varilla hexagonal 1/4" para tornillos de cabeza plana, 400mm



8252XL-1P - 8256XL-1P



1.2	6.5	1	8252XL-1P
-----	-----	---	-----------

Pack 2 varillas hex 1/4" para tornillos Pozidriv, 100 mm



8800-2P - 8830-2P



0	1	8800-2P
1	1	8810-2P
2	1	8820-2P
3	1	8830-2P

Pack 2 varillas hex 1/4" para tornillos Pozidriv, 300mm



8810L-2P - 8820L-2P



1	1	8810L-2P
2	1	8820L-2P

Pack 2 varillas hex para tornillos TORX®, 100mm



8910-2P - 8940-2P



10	1	8910-2P
15	1	8915-2P
20	1	8920-2P
25	1	8925-2P
27	1	8927-2P
30	1	8930-2P
40	1	8940-2P

Varilla hexagonal 1/4" para tornillos TORX®, 300mm



8915L-2P - 8930L-2P



T15	1	8915L-2P
T20	1	8920L-2P
T25	1	8925L-2P
T27	1	8927L-2P
T30	1	8930L-2P

Pack de 2 varillas 1/4" hexagonales con punta hexagonal, 100mm



8703-2P - 8706-2P



3	1	8703-2P
4	1	8704-2P



5
6

1 8705-2P
1 8706-2P

Destornilladores de precisión, Phillips



701

PH 00	50	14	87	5	701-00-50	
PH 0	50	14	87	5	701-0-50	
PH 0	200	14	87	5	701-0-200	
PH 1	75	14	87	5	701-1-75	
PH 1	250	14	87	5	701-1-250	

DESTORNILLADORES CON MANGO DE PRECISIÓN

Destornilladores de precisión, ranurados



700

1	50	14	87	5	700-1-50
1.2	50	14	87	5	700-1.2-50
1.5	50	14	87	5	700-1.5-50
1.8	50	14	87	5	700-1.8-50
2	50	14	87	5	700-2-50
2.5	50	14	87	5	700-2.5-50
3	50	14	87	5	700-3-50
3	100	14	87	5	700-3-100
3	200	14	87	5	700-3-200
3.5	75	14	87	5	700-3.5-75
4	75	14	87	5	700-4-75
4	250	14	87	5	700-4-250

Destornilladores de precisión, Pozidriv



702

PZ 0	50	14	87	5	702-0-50	
PZ 1	75	14	87	5	702-1-75	

Destornillador precisión, 4 bocas intercambiables Hojas intercambiables



510034

0.25x1.5, 0.3x2, 0.4x2.5, 0.5x3	8.5	10	510034	
0.25x1.5x25; 0.3x2x25; 0.4x2.5x25; 0.5x3x25				

Destornilladores de precisión, TORX®



703

T 4	50	14	87	5	703-4-50	
T 5	50	14	87	5	703-5-50	
T 6	50	14	87	5	703-6-50	
T 7	50	14	87	5	703-7-50	
T 8	50	14	87	5	703-8-50	
T 9	50	14	87	5	703-9-50	
T 10	50	14	87	5	703-10-50	
T 15	75	14	87	5	703-15-75	
T 20	75	14	87	5	703-20-75	

Destornillador para tornillos ranurados



2784

2.5	6	100	1	2784-2.5
3.5	6	104	1	2784-3.5
4.5	10	110	1	2784-4.5



Destornilladores de precisión, hexagonal esférica



704

1.5	50	14	87	5	704-1.5-50	
2	50	14	87	5	704-2-50	
2.5	50	14	87	5	704-2.5-50	
3	75	14	87	5	704-3-75	
3/32	75	14	87	5	704Z-3/32	

Juego de destornilladores de precisión, 6 piezas



706-1

6					1 706-1

700-2-50, 700-2.5-50, 700-1.5-50, 700-3-50		
701-0-50, 701-1-75		

Juego destornillador precisión relojero



98505/510031/510033

5			5 98505
6			5 510031
3			5 510033

Juego de destornilladores de precisión, 6 piezas



706-2

6					1 706-2

700-1.5-50, 700-1.2-50, 700-1-50, 700-1.8-50		
701-00-50, 701-0-50		

Juego de destornilladores de precisión, 6 piezas



706-3

6					1 706-3

700-1.2-50, 700-1.5-50, 700-1.8-50, 700-1-50, 700-2.5-50, 700-2-50		
--	--	--

Juego de destornilladores de precisión, 7 piezas



706-4

7						1 706-4

700-2.5-50, 700-3.5-75, 700-1.5-50



701-1-75, 701-0-50



703-6-50, 703-8-50



Juego de destornilladores de precisión, 24 piezas



706-5



24



1 706-5

700-3-50, 700-2-50, 700-3.5-75, 700-4-75, 700-1.5-50, 700-1.2-50,
700-1-50, 700-1.8-50



701-00-50, 701-0-50, 701-1-75



702-1-75, 702-0-50



703-6-50, 703-9-50, 703-10-50, 703-7-50, 703-8-50, 703-15-75, 703-
20-75



704-1.5-50, 704-2.5-50, 704-2-50, 704-3-75



COMPROBADORES ELÉCTRICOS

Destornillador aislado, comprobador de tensión



806



3.0	65	16	75	6 806-1-1
3.5	100	17.5	90	6 806-1-2

Comprobador 6-24V



806-1-3



3	45	16	75	6 806-1-3

Destornillador aislado, comprobador de tensión



8045VDE



3.5	77	14	92	10 8045VDE

Destornillador aislado, comprobador de tensión



8045LVDE



3.5	42	16	90	10 8045LVDE

Comprobador de corriente 6-400V



78802

6	1 78802B



DESTORNILLADORES CON MANGO EN T

Destornillador con mango en T hexagonal



900T

2	100	50	85	5	900T-020-100
2.5	100	50	85	5	900T-025-100
3	100	50	85	5	900T-030-100
4	138	50	85	5	900T-040-150
5	138	60	105	5	900T-050-150
6	185	60	105	5	900T-060-200
8	185	60	105	5	900T-080-200
10	185	60	105	5	900T-100-200

Destornillador con mango en T TORX®



901T

T 6	100	50	85	5	901T-006-100
T 7	100	50	85	5	901T-007-100
T 8	100	50	85	5	901T-008-100
T 9	100	50	85	5	901T-009-100
T 10	100	50	85	5	901T-010-100
T 15	138	50	85	5	901T-015-150
T 20	138	50	85	5	901T-020-150
T 25	138	60	105	5	901T-025-150
T 27	138	60	105	5	901T-027-150
T 30	185	60	105	5	901T-030-200
T 40	185	60	105	5	901T-040-200
T 45	185	60	105	5	901T-045-200
T 50	185	60	105	5	901T-050-200

Destornillador con mango en T Stecker



902T

5	136	50	85	5	902T-050-150
5.5	136	50	85	5	902T-055-150
6	136	50	85	5	902T-060-150
7	160	60	105	5	902T-070-175

8	160	60	105	5	902T-080-175
9	160	60	105	5	902T-090-175
10	160	60	105	5	902T-100-175
11	160	60	105	5	902T-110-175
12	160	60	105	5	902T-120-175
13	160	60	105	5	902T-130-175

Porta vasos mango en T, 1/4"



905T

1/4"	45	60	105	5	905T-060-100

Juego 6 destornilladores mango en T hexagonales
3-4-5-6-8-10 mm



903T-1

6				1 903T-1

900T-030-100, 900T-040-150, 900T-050-150, 900T-060-200, 900T-080-200, 900T-100-200

Juego 6 destornilladores mango en T, TORX®
T-10, T-15, T-20, T-25, T-30, T-40



903T-2

6				1 903T-2

901T-010-100, 901T-015-150, 901T-020-150, 901T-025-150, 901T-030-200, 901T-040-200



Juego 6 destornilladores mango en T, Stecker
5-6-7-8-10-13 mm



903T-3



6

1 903T-3

902T-050-150, 902T-060-150, 902T-070-175, 902T-080-175, 902T-100-175, 902T-130-175



DESTORNILLADORES PORTAPUNTAS DE 1/4"

Destornillador Portapuntas Magnetico 1/4" BahcoFit



B705



1/4" 125 30 105 5 B705.1/4.125

1/4" 125 30 105 1 SB705.1/4.125

SB: Presentación en clip

Portapuntas 1/4"



808050A/TORX



1/4 115 40 115 mm 1 808050A

1/4 115 40 115 mm 50 808050TORX

Destornillador porta puntas con mango en T



904T



1/4"

150

5 904T-060-150

DESTORNILLADORES CON MANGO DE MADERA O PLASTICO

Destornillador de electrónica para tornillos ranurados y tornillos ranurados prisioneros



7372I



2.0 63 13 80 10 7372I-2-63

2.5 75 13 80 10 7372I-2.5-75

3.0 80 13 80 10 7372I-3-80

Destornillador para tornillos ranurados con mango de madera



9710



3.5 75 22 95 10 9710-3.5-75

5.5 100 24 100 10 9710-5.5-100

6.5 125 27 110 10 9710-6.5-125

8.0 150 30 120 5 9710-8-150

10.0 175 32 125 5 9710-10-175



Destornillador con mango de madera
Para tornillos Phillips



9778



PH 1	80	24	100	10	9778-1
PH 2	110	27	110	10	9778-2
PH 3	150	30	120	5	9778-3

Destornillador con mango de madera
Para tornillos Pozidriv



9778PZD



PZ 1	80	24	100	10	9778PZD-1
PZ 2	110	27	110	10	9778PZD-2

Juego de 6 destornilladores con mango de madera
Para tornillos Ranurados y Phillips



9710/S6



6	1	9710/S6

9710-4.5-90

9710-5.5-100, 9710-6.5-125, 9710-8-150

9778-1, 9778-2



Destornillador reversible
Ranurado, Phillips



1019/1067/13561



4,5	PH 1	10	1067
6	PH 2	10	1019

1019: mango de acetato (naranja) 13561: mango de polipropileno (negro)

Destornillador varilla reversible



8052



PH 2	80	28	110	5	8052

Destornillador extracorto varilla reversible



1016



6	PH 2	10	1016

Para tornillos phillips y planos

Juego de destornillador con 6 varillas reversibles



6



PH 0, PH 1, PH 2



3,5-5,0-6,5



1 6

ACCESORIOS

Imantador - Desimantador



M780



29 x 52 x 50 mm



1 M780

Magnetizador - Desmagnetizador



M781



22 x 125 x 40 mm



5 M781





BAHCO



Llaves acodadas



CON PUNTA HEXAGONAL

Llave hexagonal, mm



1997M

Hexagonal Tip (mm)	Length (mm)	Quantity	Part Number
3.5	70	10	1997M-3.5
4	74	10	1997M-4
4.5	80	10	1997M-4.5
5	85	10	1997M-5
6	96	10	1997M-6
7	102	10	1997M-7
8	108	10	1997M-8
9	114	10	1997M-9
10	122	10	1997M-10
11	129	10	1997M-11
12	137	5	1997M-12
14	154	5	1997M-14
16	168	1	1997M-16
17	177	1	1997M-17
19	199	1	1997M-19

Llave hexagonal acodada, niquelada



1998M

Hexagonal Tip (mm)	Length (mm)	Quantity	Part Number
1.5	47	10	1998M-1.5
2	52	10	1998M-2
2.5	59	10	1998M-2.5
3.0	66	10	1998M-3
4.0	74	10	1998M-4
5.0	85	10	1998M-5
6.0	96	10	1998M-6
7.0	102	10	1998M-7
8.0	108	10	1998M-8
9.0	114	5	1998M-9
10	122	10	1998M-10
12.0	137	5	1998M-12
14.0	154	1	1998M-14
17.0	177	1	1998M-17
19.0	199	1	1998M-19
22.0	222	1	1998M-22

Llave acodada pavonada, mm



1995M

Hexagonal Tip (mm)	Length (mm)	Quantity	Part Number
0.9	33	10	1995M-0.9
1.5	47	10	1995M-1.5
2.0	52	10	1995M-2
2.5	59	10	1995M-2.5
3.0	66	10	1995M-3
4.0	74	10	1995M-4
5.0	85	10	1995M-5
6.0	96	10	1995M-6
7.0	102	10	1995M-7
8.0	108	10	1995M-8
9.0	114	10	1995M-9
10	122	10	1995M-10
12	137	10	1995M-12
14	154	10	1995M-14
17	177	10	1995M-17
19	199	10	1995M-19
22	222	10	1995M-22

Juego de 7 llaves hexagonales acodadas cromadas
7 piezas



1997M/7T

Hexagonal Tip (mm)	Quantity	Part Number
2, 3, 4, 5, 6, 7, 8 mm	1	1997M/7T

1997M-4, 1997M-5, 1997M-6, 1997M-7,
1997M-8

Juego de 10 llaves hexagonales acodadas cromadas
10 piezas



1997M/10T

Hexagonal Tip (mm)	Quantity	Part Number
1.5, 2, 2.5, 3, 3.5, 4, 4.5, 5, 6, 8 mm	1	1997M/10T

1997M-1.5, 1997M-2, 1997M-2.5,
1997M-3, 1997M-3.5, 1997M-4,
1997M-4.5, 1997M-5, 1997M-6,
1997M-8

Juego de 11 llaves acodadas cromadas
11 piezas



1997M/11T

Hexagonal Tip (mm)	Quantity	Part Number
2, 3, 4, 5, 6, 7, 8, 9, 10, 11, 12 mm	1	1997M/11T

1997M-2, 1997M-3, 1997M-4, 1997M-5,
1997M-6, 1997M-7, 1997M-8, 1997M-9,
1997M-10, 1997M-11, 1997M-12

Juego de 6 llaves acodadas, métrica, acabado
niquelado
6 piezas



1998M/

Hexagonal Tip (mm)	Quantity	Part Number
2, 2.5, 3, 4, 5, 6 mm	1	1998M/6T

1998M-2, 1998M-2.5, 1998M-3, 1998M-4,
1998M-5, 1998M-6

Juego de 9 llaves hexagonales acodadas cromadas



BE-9778



1.5, 2, 2.5, 3, 4, 5, 6, 8, 10 mm

1 BE-9778

1997M-1.5, 1997M-2, 1997M-2.5,
1997M-3, 1997M-4, 1997M-5, 1997M-6,
1997M-8, 1997M-10



Juego de 8 llaves hexagonales acodadas niqueladas
8 piezas



1998M/8T



2, 2.5, 3, 4, 5, 6, 7, 8 mm

1 1998M/8T

1998M-2, 1998M-2.5, 1998M-3,
1998M-4, 1998M-5, 1998M-6, 1998M-7,
1998M-8



Juego de 10 llaves acodadas niqueladas
10 piezas



1998M/10T



2, 2.5, 3, 4, 5, 6, 7, 8, 9, 10 mm

1 1998M/10T

Tamaños marcados en el envase para su fácil elección

1998M-2, 1998M-2.5, 1998M-3, 1998M-4,
1998M-5, 1998M-6, 1998M-7, 1998M-8,
1998M-9, 1998M-10



Juego de 11 llaves hexagonales acodadas niqueladas
10 piezas



1998M/11T



2, 2.5, 3, 4, 5, 6, 7, 8, 9, 10, 12 mm

1 1998M/11T

1998M-2, 1998M-2.5, 1998M-3, 1998M-4,
1998M-5, 1998M-6, 1998M-7, 1998M-8,
1998M-9, 1998M-10, 1998M-12



Juego de 15 llaves hexagonales acodadas niqueladas
15 piezas



1998M/15T



2, 2.5, 3, 4, 5, 6, 7, 8, 9, 10, 12,
14, 17, 19, 22 mm

1 1998M/15T

1998M-2, 1998M-2.5, 1998M-3,
1998M-4, 1998M-5, 1998M-6, 1998M-7,
1998M-8, 1998M-9, 1998M-10, 1998M-12,
1998M-14, 1998M-17, 1998M-19,
1998M-22



Juego 8 llaves hexagonales acodadas en aro,
niqueladas
8 piezas



1998M/8R



2, 2.5, 3, 4, 5, 6, 7, 8 mm

1 1998M/8R

2, 2.5, 3, 4, 5, 6, 7, 8 mm

Juego de 7 llaves hexagonales acodadas



1999M/7H



2.5 3 4 5 6 8 10

1 1999M/7H

Juego de 6 llaves hexagonales acodadas pavonadas
6 piezas



1995M/



2, 2.5, 3, 4 5, 6 mm

1 1995M/6T

1995M-2, 1995M-2.5, 1995M-3, 1995M-4,
1995M-5, 1995M-6



Juego de 8 llaves hexagonales acodadas pavonadas
8 piezas



1995M/8T

2, 2.5, 3, 4, 5, 6, 7, 8 mm	1	1995M/8T

1995M-2, 1995M-2.5, 1995M-3,
1995M-4, 1995M-5, 1995M-6, 1995M-7,
1995M-8

Juego de 10 llaves acodadas pavonadas hexagonal,
mm
10 piezas



1995M/10T

2, 2.5, 3, 4, 5, 6, 7, 8, 9, 10 mm	1	1995M/10T

1995M-10, 1995M-2, 1995M-2.5,
1995M-3, 1995M-4, 1995M-5, 1995M-6,
1995M-7, 1995M-8, 1995M-9

Juego de 11 llaves acodadas pavonadas hexagonales,
mm
11 piezas



1995M/11T

2, 2.5, 3, 4, 5, 6, 7, 8, 9, 10, 12 mm	1	1995M/11T

1995M-10, 1995M-12, 1995M-2, 1995M-
2.5, 1995M-3, 1995M-4, 1995M-5,
1995M-6, 1995M-7, 1995M-8, 1995M-9

Juego de 15 llaves acodadas pavonadas hexagonales,
mm
15 piezas



1995M/15T

2, 2.5, 3, 4, 5, 6, 7, 8, 9, 10, 12, 14, 17, 19, 22 mm	1	1995M/15T

1995M-10, 1995M-12, 1995M-14,
1995M-17, 1995M-19, 1995M-2, 1995M-
2.5, 1995M-22, 1995M-3, 1995M-4,
1995M-5, 1995M-6, 1995M-7, 1995M-8,
1995M-9

Juego de 9 llaves hexagonales acodadas pavonadas



BE-9578

1.5, 2, 2.5, 3, 4, 5, 6, 8, 10 mm	1	BE-9578

1995M-1.5, 1995M-10, 1995M-2,
1995M-2.5, 1995M-3, 1995M-4, 1995M-
5, 1995M-6, 1995M-8

Juego de 6 llaves hexagonales acodadas pavonadas



BE-9586

1.5, 2, 2.5, 3, 4, 5 mm	1	BE-9586

1995LM-1.5, 1995LM-2, 1995LM-2.5,
1995LM-3, 1995LM-4, 1995LM-5

Juego de 7 llaves hexagonales acodadas



BE-9777B

2.5 3 4 5 6 8 10	6	BE-9777B

Juego de 7 llaves hexagonales



BE-9776

1.5, 2, 2.5, 3, 4, 5, 6	6	BE-9776

Juego de 7 llaves hexagonales en navaja



BE-9777

2.5, 3, 4, 5, 6, 8, 10	6	BE-9777

Llave acodada pavonada serie larga, mm



1995LM

1.5	91	10 1995LM-1.5
2	102	10 1995LM-2

Ø	L	Icon 1	Icon 2
2.5	114	10	1995LM-2,5
3.0	129	10	1995LM-3
4.0	144	10	1995LM-4
5.0	165	10	1995LM-5
6.0	186	10	1995LM-6
7.0	197	10	1995LM-7
8.0	208	10	1995LM-8
9.0	219	10	1995LM-9
10	234	10	1995LM-10
12	262	10	1995LM-12
14	294	10	1995LM-14

Llave hexagonal acodada, con bola, pavonada



1996M

Ø	L	Icon 1	Icon 2
1.5	91	10	1996M-1.5
2.0	102	10	1996M-2
2.5	114	10	1996M-2.5
3.0	129	10	1996M-3
4.0	144	10	1996M-4
5.0	165	10	1996M-5
6.0	186	10	1996M-6
8.0	208	10	1996M-8
10	234	10	1996M-10
12	262	10	1996M-12

Llave acodada, pulgadas, pavonada



1995Z

Ø	L	Icon 1	Icon 2
1/16	47	10	1995Z-1/16
5/64	52	10	1995Z-5/64
3/32	59	10	1995Z-3/32
1/8	66	10	1995Z-1/8
5/32	74	10	1995Z-5/32
3/16	85	10	1995Z-3/16
7/32	91	10	1995Z-7/32
1/4	96	10	1995Z-1/4
5/16	108	10	1995Z-5/16
3/8	122	10	1995Z-3/8
7/16	129	10	1995Z-7/16
1/2	145	10	1995Z-1/2
5/8	168	10	1995Z-5/8
3/4	199	10	1995Z-3/4

Juego de 10 llaves acodadas hex pavonadas, pulgadas
10 piezas



1995Z/

Ø	Icon 1	Icon 2
1/16, 5/64, 3/32, 1/8, 5/32, 3/16, 7/32, 1/4, 5/16, 3/8 in	1	1995Z/10T

1995Z-1/16, 1995Z-1/4, 1995Z-1/8, 1995Z-3/16, 1995Z-3/32, 1995Z-3/8, 1995Z-5/16, 1995Z-5/32, 1995Z-5/64, 1995Z-7/32

Juego de 12 llaves acodadas pavonadas, pulgadas



1995Z/12T

Ø	Icon 1	Icon 2
1/16, 5/64, 3/32, 1/8, 5/32, 3/16, 7/32, 1/4, 5/16, 3/8, 7/16, 1/2 in	1	1995Z/12T

1995Z-1/16, 1995Z-1/2, 1995Z-1/4, 1995Z-1/8, 1995Z-3/16, 1995Z-3/32, 1995Z-3/8, 1995Z-5/16, 1995Z-5/32, 1995Z-5/64, 1995Z-7/16, 1995Z-7/32

Juego de 7 llaves hexagonales



BE-9787

Ø	Icon 1	Icon 2
3/32 1/8 5/32 3/16 1/4 5/16 3/8 in	6	BE-9787

Juego de 7 llaves hex con bola



BE-9776B

Ø	Icon 1	Icon 2
2.5, 3, 4, 5, 6, 8, 10	6	BE-9776B

Juego 12 llaves acodadas hex niqueladas serie larga, pulgadas



BE-9880

Ø	Icon 1	Icon 2
0.050; 1/16; 5/64; 3/32; 7/64; 1/8; 9/64; 5/32; 3/16; 7/32; 1/4; 5/16 mm	3	BE-9880

Juego de 9 llaves acodadas serie larga



BE-9588

Ø	Icon 1	Icon 2
1.5, 2, 2.5, 3, 4, 5, 6, 8, 10 mm	1	BE-9588

1995LM-1.5, 1995LM-10, 1995LM-2, 1995LM-2.5, 1995LM-3, 1995LM-4, 1995LM-5, 1995LM-6, 1995LM-8



Juego de 6 llaves hexagonales acodadas con bola pavonadas



BE-9765



1.5, 2, 2.5, 3, 4, 5 mm

3 BE-9765

1996M-1.5, 1996M-2, 1996M-2.5,
1996M-3, 1996M-4, 1996M-5



Juego de 9 llaves acodadas pavonadas hex bola, mm



BE-9770



1.5, 2, 2.5, 3, 4, 5, 6, 8, 10 mm

3 BE-9770

1996M-1.5, 1996M-10, 1996M-2,
1996M-2.5, 1996M-3, 1996M-4, 1996M-
5, 1996M-6, 1996M-8



Juego de 6 llaves hexagonales acodadas con bola pavonadas



BE-9676



1.5, 2, 2.5, 3, 4, 5 mm

1 BE-9676

1996M-1.5, 1996M-2, 1996M-2.5,
1996M-3, 1996M-4, 1996M-5



Juego de 9 llaves acodadas pavonadas Hex Bola serie larga



BE-9678



1.5, 2, 2.5, 3, 4, 5, 6, 8, 10 mm

1 BE-9678

1996M-1.5, 1996M-10, 1996M-2,
1996M-2.5, 1996M-3, 1996M-4, 1996M-
5, 1996M-6, 1996M-8



Juego de llaves hexagonales acodadas con bola + imantador-desimantador en petaca, 9 piezas



BE-9688



1.5, 2, 2.5, 3, 4, 5, 6, 8, 10 mm

1 BE-9688

1996M-1.5, 1996M-10, 1996M-2,
1996M-2.5, 1996M-3, 1996M-4, 1996M-
5, 1996M-6, 1996M-8



Juego de 12 llaves acodadas hex bola serie larga, pulgadas



BE-9780



0.05 1/16 5/64 3/32 7/64
1/8 9/64 5/32 3/16 7/32
1/4 5/16 in

3 BE-9780

Juego de 13 llaves acodadas hex bola serie larga, pulgadas



BE-9785



0.05 1/16 5/64 3/32 7/64 1/8
9/64 5/32 3/16 7/32 1/4 5/16
3/8 in

3 BE-9785

Juego de 7 llaves hexagonales



BE-9775-BE-9785



1/16, 5/64, 3/32, 1/8, 5/32,
3/16, 1/4 in

3 BE-9775

CON PUNTA TORX®

Llave acodada TORX®, pavonada



1995TORX



T 6	75	5	1995TORX-T6
T 7	80	5	1995TORX-T7
T 8	80	5	1995TORX-T8
T 9	80	5	1995TORX-T9
T 10	86	5	1995TORX-T10
T 15	90	5	1995TORX-T15
T 20	95	5	1995TORX-T20
T 25	100	5	1995TORX-T25
T 27	105	5	1995TORX-T27
T 30	114	5	1995TORX-T30
T 40	124	5	1995TORX-T40
T 45	133	5	1995TORX-T45
T 50	152	5	1995TORX-T50
T 55	184	5	1995TORX-T55
T 60	204	5	1995TORX-T60

Llave acodada TORX® inviolable, pavonada



1986TORX

Icon	Length (L)	Icon	Icon
★			
TR 9	80	5	1986TORX-T9
TR 10	86	5	1986TORX-T10
TR 15	90	5	1986TORX-T15
TR 20	95	5	1986TORX-T20
TR 25	100	5	1986TORX-T25
TR 27	105	5	1986TORX-T27
TR 30	114	5	1986TORX-T30
TR 40	124	5	1986TORX-T40

Juego de 8 llaves acodadas pavonadas TORX® 8 piezas



BE-8975B

Icon	Icon	Icon	Icon
★			
T 9 - T 10 - T 15 - T 20 - T 25 - T 27 - T 30 - T 40	6	BE-8975B	

Juego de 8 llaves para tornillos TORX®



BE-8975

Icon	Icon	Icon	Icon
★			
T 9 10 15 20 25 27 30 40	6	BE-8975	

Juego de 8 llaves TORX® acodadas



BE-8976B

Icon	Icon	Icon	Icon
★			
T9, T10, T15, T20, T25, T27, T30, T40	6	BE-8976B	

Juego de 8 llaves acodadas TORX® inviolables



BE-8675

Icon	Icon	Icon	Icon
★			
T9, T10, T15, T20, T25, T27, T30, T40	1	BE-8675	

1986TORX-T9, 1986TORX-T10, 1986TORX-T15, 1986TORX-T20, 1986TORX-T25, 1986TORX-T27, 1986TORX-T30, 1986TORX-T40	★	✓
---	---	---

Juego de 8 llaves acodadas TORX® pavonadas



BE-9575

Icon	Icon	Icon	Icon
★			
T9, T10, T15, T20, T25, T27, T30, T40	1	BE-9575	

1995TORX-T9, 1995TORX-T10, 1995TORX-T15, 1995TORX-T20, 1995TORX-T25, 1995TORX-T27, 1995TORX-T30, 1995TORX-T40	★	✓
---	---	---

Llave acodada TORX®, con bola, pavonada



1996TORX

Icon	Length (L)	Icon	Icon
★			
T 9	80	5	1996TORX-T9
T 10	86	5	1996TORX-T10
T 15	90	5	1996TORX-T15
T 20	95	5	1996TORX-T20
T 25	100	5	1996TORX-T25
T 27	105	5	1996TORX-T27
T 30	114	5	1996TORX-T30
T 40	124	5	1996TORX-T40
T 45	133	5	1996TORX-T45
T 50	152	5	1996TORX-T50

Juego de 8 llaves Torx® acodadas con bola, pavonadas



BE-9675

Icon	Icon	Icon	Icon
★			
T9, T10, T15, T20, T25, T27, T30, T40	1	BE-9675	

1996TORX-T9, 1996TORX-T10, 1996TORX-T15, 1996TORX-T20, 1996TORX-T25, 1996TORX-T27, 1996TORX-T30, 1996TORX-T40	★	✓
---	---	---

Juego 5 llaves acodadas TORX® con bola



1996TORX/

Icon	Icon	Icon	Icon
★			
T10, T20, T25, T30, T40	1	1996TORX/5T	

1996TORX-T10, 1996TORX-T20, 1996TORX-T25, 1996TORX-T30, 1996TORX-T40	★	✓
--	---	---



Juego 4 llaves acodadas TORX®



1995TORX/



10, 20, 30, 40

1 1995TORX/4T

1995TORX-T10, 1995TORX-T20,
1995TORX-T30, 1995TORX-T40



Juego de 7 llaves acodadas pavonadas TORX®



1995TORX/7T



10, 15, 20, 25, 27, 30, 40

1 1995TORX/7T

1995TORX-T10, 1995TORX-T15,
1995TORX-T20, 1995TORX-T25,
1995TORX-T27, 1995TORX-T30,
1995TORX-T40



Juego de 11 llaves acodadas pavonadas TORX®



1995TORX/11T



7, 9, 10, 15, 20, 25, 27,
30, 40, 45, 50

1 1995TORX/11T

1995TORX-T10, 1995TORX-T15,
1995TORX-T20, 1995TORX-T25,
1995TORX-T27, 1995TORX-T30,
1995TORX-T40, 1995TORX-T45,
1995TORX-T50, 1995TORX-T7,
1995TORX-T9



Juego de 13 llaves acodadas pavonadas TORX®, mm



1995TORX/13T



6, 7, 8, 9, 10, 15, 20, 25,
27, 30, 40, 45, 50

1 1995TORX/13T

1995TORX-T10, 1995TORX-T15,
1995TORX-T20, 1995TORX-T25,
1995TORX-T27, 1995TORX-T30,
1995TORX-T40, 1995TORX-T45,
1995TORX-T50, 1995TORX-T6,
1995TORX-T7, 1995TORX-T8,
1995TORX-T9



Juego de 8 llaves acodadas TORX® pavonadas Magnetizador



BE-9585



T9, T10, T15, T20, T25, T27, T30, T40

1 BE-9585

1995TORX-T10, 1995TORX-T15,
1995TORX-T20, 1995TORX-T25,
1995TORX-T27, 1995TORX-T30,
1995TORX-T40, 1995TORX-T9



Juego 7 llaves acodadas TORX® inviolable



1986TORX/



TR10, TR15, TR20, TR25,
TR27, TR30, TR40

1 1986TORX/7T

1986TORX-T10, 1986TORX-T15,
1986TORX-T20, 1986TORX-T25,
1986TORX-T27, 1986TORX-T30,
1986TORX-T40



Llave acodada TORX PLUS®, pavonada



1976TORX



IP 6	75	5	1976TORX-T6
IP 7	80	5	1976TORX-T7
IP 8	80	5	1976TORX-T8
IP 9	80	5	1976TORX-T9
IP 10	86	5	1976TORX-T10
IP 15	90	5	1976TORX-T15
IP 20	95	5	1976TORX-T20
IP 25	100	5	1976TORX-T25
IP 27	105	5	1976TORX-T27
IP 30	114	5	1976TORX-T30
IP 40	124	5	1976TORX-T40

Juego 5 llaves acodadas TORX PLUS® pavonadas



1976TORX/



IP 10, IP 20, IP 25, IP 30, IP 40

1 1976TORX/5T

1976TORX-T10, 1976TORX-T20,
1976TORX-T25, 1976TORX-T30,
1976TORX-T40



Juego de 8 llaves TORX PLUS® acodada pavonada



BE-7675



IP9, IP10, IP15, IP20, IP25, IP27,
IP30, IP40

1 BE-7675

1976TORX-T10, 1976TORX-T15,
1976TORX-T20, 1976TORX-T25,
1976TORX-T27, 1976TORX-T30,
1976TORX-T40, 1976TORX-T9







ACODADAS

Destornillador acodado boca recta



2047



			
4.0	100	5	2047-0.8-4
5.5	125	5	2047-1-5.5
8.0	150	5	2047-1.2-8
10.0	175	1	2047-1.6-10
12.0	200	1	2047-2-12

Destornillador acodado boca Phillips



2047PR



			
PH 1 & 2	100	5	2047PR-1-2
PH 3 & 4	200	5	2047PR-3-4

Destornillador acodado doble boca para tornillos Pozidriv



2047PZ



			
PZ1, PZ2	100	5	2047PZ-1-2





BAHCO



Alicates



ALICATES DE CORTE

Alicate de corte diagonal con filos progresivos
Para cuerda de piano y materiales blandos: cobre, plástico

ergo®



2101G

Cu mm	Fila mm	Piano mm	L		
3.5	1.8	1.6	125	5	2101G-125
3.7	2.0	1.8	140	5	2101G-140
3.8	2.5	2.0	160	5	2101G-160
4.0	2.7	2.3	180	5	2101G-180
3.5	1.8	1.6	125	5	2101G-125IP
3.7	2.0	1.8	140	5	2101G-140IP
3.8	2.5	2.0	160	5	2101G-160IP
4.0	2.7	2.3	180	5	2101G-180IP

IP: Embalaje industrial

Alicate de corte diagonal con filos progresivos
Para alambre de piano y materiales más blandos como el cobre y el plástico

ergo®



2101G

Cu mm	Fila mm	Piano mm	L		
3.5 mm	1.8 mm	1.6 mm	125	5	2101G-125IPD
3.7 mm	2.0 mm	1.8 mm	140	5	2101G-140IPD
3.8 mm	2.5 mm	2.0 mm	160	5	2101G-160IPD
4.0 mm	2.7 mm	2.3 mm	180	5	2101G-180IPD

Alicate de corte diagonal para plástico
Corte limpio

ergo®



2101PG

L		
160	5	2101PG-160

PLASTICO

Alicate de corte lateral cromado plateado con filos progresivos
Para alambre de piano y materiales blandos como cobre o plástico

ergo®



2101GC

Cu mm	Fila mm	Piano mm	L		
3.5	1.8	1.6	125	5	2101GC-125IP
3.7	2.0	1.8	140	5	2101GC-140IP
3.8	2.5	2.0	160	5	2101GC-160IP
4.0	2.7	2.3	180	5	2101GC-180IP

IP: Embalaje industrial

Alicates de corte diagonal con filo progresivo
Para cuerda de piano y materiales blandos: cobre, plástico



2101D

Cu mm	Fila mm	Piano mm	L		
3.5	1.8	1.6	125	5	2101D-125
3.7	2.0	1.8	140	5	2101D-140
3.8	2.5	2.0	160	5	2101D-160
4.0	2.7	2.3	180	5	2101D-180
3.5	1.8	1.6	125	5	2101D-125IP
3.7	2.0	1.8	140	5	2101D-140IP
3.8	2.5	2.0	160	5	2101D-160IP
4.0	2.7	2.3	180	5	2101D-180IP

IP: Embalaje industrial

Alicate cortante "Heavy Duty"
Para alambres duros y cuerda piano

ergo®



21HDG

Fila mm	Piano mm	L		
2.2	2.2	140	5	21HDG-140
2.5	2.5	160	5	21HDG-160
2.8	2.8	180	5	21HDG-180
3.2	3.0	200	5	21HDG-200
2.2	2.2	140	5	21HDG-140IP
2.5	2.5	160	5	21HDG-160IP
2.8	2.8	180	5	21HDG-180IP
3.2	3.0	200	5	21HDG-200IP

IP: Embalaje industrial

Alicate cortante angulado 14° para aplicaciones "Heavy Duty"
Para cortar alambre duro y cuerda piano

ergo®



21HDG-A

Fase mm	Diámetro mm	L	Iconos
2.2	2.0	140	5 21HDG-140A
2.5	2.3	160	5 21HDG-160A
2.7	2.5	180	5 21HDG-180A
3.2	3.0	200	5 21HDG-200A

Alicate cortante "Heavy Duty" cromado
Para alambres duros y cuerda piano

ergo®



21HDGC

Fase mm	Diámetro mm	L	Iconos
2.2	2.2	140	5 21HDGC-140IP
2.5	2.5	160	5 21HDGC-160IP
2.8	2.8	180	5 21HDGC-180IP
3.2	3.0	200	5 21HDGC-200IP

IP: Embalaje industrial

Alicate cortante extra fuerte "Heavy Duty"
Para cortar alambres duros y cuerda piano



21HDD

Fase mm	Diámetro mm	L	Iconos
2.2	2.2	140	5 21HDD-140
2.5	2.5	160	5 21HDD-160
2.8	2.8	180	5 21HDD-180
3.2	3.0	200	5 21HDD-200
2.2	2.2	140	5 21HDD-140IP
2.5	2.5	160	5 21HDD-160IP
2.8	2.8	180	5 21HDD-180IP
3.2	3.0	200	5 21HDD-200IP

IP: Embalaje industrial

Alicate cortante diagonal, filos céntricos de precisión
Para cuerda de piano y alambre blando



1520G

Fase mm	L	Iconos
3.8	210	5 1520 G

Extrafuerte muy versátil

Alicate cortante diagonal, filos céntricos de precisión
Para cuerda de piano y blando



1520D

Fase mm	L	Iconos
3.8	205	5 1520 D

Alicate de corte diagonal

ergo®



4130, 4131

Cu mm	L	Iconos
0.3-1.5	120	3 4130
0.3-1.5	120	3 4131



Alicate de corte diagonal, cabeza ovalada



C3140

Cu mm	L		
0,4-2,0 mm	130	10	C3140
0,4-2,0 mm	130	10	C3140IP

IP: Embalaje industrial

Alicate cortante, cabeza cónica y rebajada



C3330

Cu mm	L		
0,3-1,6 mm	115	10	C3330
0,3-1,6 mm	115	10	C3330IP

IP: Embalaje industrial

Alicate cortante, cabeza rebajada



C3330R/C3340R

Cu mm	L		
0,3-1,25 mm	115	10	C3330R
0,3-1,25 mm	115	10	C3330R IP
0,4-1,6 mm	130	10	C3340R
0,4-1,6 mm	130	10	C3340R IP

IP: Embalaje industrial

Alicate de corte diagonal para plástico
Corte tipo Flush



2100PD

Cu mm	Plástico mm	L	
1.8 mm	3.0 mm	150	5 2100PD-150

Máx capacidad Cu1.8mm y plástico PA (Bylon) 3mm

Alicates de corte oblicuo para plástico
Corte limpio, plano de corte a 90°



2190PD

Cu mm	Plástico mm	L	
1.8 mm	3.0 mm	143	5 2190PD-150

PLASTIC

Alicate de corte lateral



2171G

Cu mm	Fe+ mm	Plástico mm	L	
2.5	1.6	1.5	150	5 2171G-140
2.5	1.6	1.5	160	5 2171G-160
2.5	1.6	1.5	185	5 2171G-180

Alicates de corte diagonal cromado
Para alambre duro



2666NB-2676NB

Cu mm	Fase mm	L	Icon	Icon
2.7	2.0	160	1	2674 NB

Alicates de corte diagonal cromado
Para cuerda de piano



2667B-2678B

Cu mm	Fase mm	Diámetro mm	L	Icon	Icon
3.7	2.0	2.0	160	1	2676 B
4.0	2.5	2.5	200	1	2678 B

Alicates de corte diagonal
Cabeza ovalada



2646M - 2649

Cu mm	Icon	L	Icon	Icon
0.1-0.8	Ultra	108	1	2646 M
0.2-1.25	Micro	110	1	2646 R
0.2-1.25	Micro	110	1	2646 RK
0.1-1.0	Ultra	110	1	2646 RA
0.3-1.6	Micro	1125.5	1	2666
0.4-2.0	Micro	125	1	2649

Alicates de corte diagonal
Cabeza cónica



2646 - 2648A

Cu mm	Icon	L	Icon	Icon
0.2-1.25	Micro	110	1	2646
0.2-1.25	Micro	110	1	2646 K
0.1-1.0	Ultra	110	1	2646 A
0.1-1.0	Ultra	110	1	2646 AK
0.2-1.25	Ultra	112.5	1	2666 FK
0.4-2.0	Micro	125	1	2648
0.3-1.6	Ultra	125	1	2648 A

Alicates de corte oblicuo

ergo®



4231

Cu mm	L	Icon	Icon
0.3-1.25	119	3	4231

Alicates de corte oblicuo 45°

ergo®



4239

Cu mm	L	Icon	Icon
0.3-1.0	129	3	4239



Alicate de corte oblicuo para plástico
Corte limpio, filo de corte a 45°



2145PD

3.0 mm	1.8 mm	154	5	2145PD-150

Alicate de corte oblicuo 45°



2787F

0.2-1.0	Flush	117.5	1	2787 F

Alicate de corte oblicuo 45°



2787G

0.2-0.8	Flush	117.5	1	2787 G

Alicate cortante frontal para cuerda de piano



527 GC

2.0	160	3	527 GC-160
2.5	200	3	527 GC-200

Alicates de corte frontal pavonados
Para alambre de piano



527D

2	160	3	527 D-160
2.5	200	5	527 D-200

Tenaza rusa, alambre de hierro



2339D

2.2	220	3	2339 D
2.2	220	5	2339 DIP
4.5 mm	300	5	2339D-300
4.5 mm	300	6	2339D-300IP

IP: Embalaje industrial

Tenaza de encofrador, modelo ruso



2339

Fø mm	L		
2.2	220	5	2339-220IP
2.5	250	5	2339-250IP
3.0	280	5	2339-280IP
4.5	300	5	2339-300IP

IP: Embalaje industrial

Tenaza de carpintero, alambre de hierro



541D

Fø mm	L		
2.0	150	5	541 D-150
2.0	180	5	541D-180
2.5	200	5	541 D-200
2.5	225	5	541D-225
2.5	250	5	541 D-250

Alicates de corte frontal pavonados
Para alambre de piano



1519D

Fø mm	L		
2.5	230	3	1519 D
		1	1519-9

Alicate de corte frontal



C3230

L			
109	10		C3230
109	10		C3230IP

IP: Embalaje industrial

Alicate de corte frontal



2656/2656A

Fø mm		L		
0.35 - 0.8	Micro	115	1	2656

Alicates de corte lateral cromados plateados
Para alambre de acero duro



2686

Fø mm	L		
2	160	1	2686



Cortacables y pelacables
Para alambre de cobre y aluminio



2233D

Cu mm	+	+	L		
10	50/35		160	5	2233 D-160
13	70/50		200	5	2233 D-200
16	95/70		240	5	2233 D-240
10	50/35		160	5	2233D-160IP
13	70/50		200	5	2233D-200IP
16	95/70		240	5	2233D-240IP

IP: Embalaje industrial

Cortacables para cobre y aluminio



2260G

L		
210	5	2260 G-210

Cortacables
Para aluminio y cobre



2520

L		
550	1	2520
220	1	2520-SH

2520-SH: hojas de repuesto, tornillos y tuerca

Cortacables para cobre



2620-80

	L		
42 mm	800	1	2620-80

Cortacables de acero



2720

	L		
42 mm	600	1	2720
	163	1	2720-SH

2720-SH: Hoja de repuesto para 2720

Cortacables de acero



2235-160

L		
165	1	2235-160

Cortacables con carraca
Para Cu y Al



2804-2805

Diagram 1	Diagram 2	Diagram 3	Diagram 4	Diagram 5
16	34	250	1	2804
22	52	280	1	2805-280

Cortacables
Para alambre de cobre revestido con plástico



2800N-2801N

Diagram 1	Diagram 2	Diagram 3	Diagram 4
0-10	170	1	2800 N
0-15	230	1	2801 N

Cortavarillas



4559

Diagram 1	Diagram 2	Diagram 3	Diagram 4	Diagram 5	Diagram 6
6	5	4	320	1	4559-12
8	7	6	430	8	4559-18
10	9	8	600	6	4559-24
13	10	9	750	5	4559-30
15	12	11	900	3	4559-36
15	12	11	1060	2	4559-42

Cabeza de corte de recambio para cortavarillas 4559



4559 JC

g	Diagram 1	Diagram 2
285	1	4559-12A JC
600	1	4559-18B JC
930	1	4559-24B JC
1260	1	4559-30B JC
2180	1	4559-36B JC
3025	1	4559-42A JC

Cortavarillas de corte diagonal, mm



4560-210

Diagram 1	Diagram 2	Diagram 3
250	1	4560-210

ALICATES UNIVERSALES

Alicates universales



2628G

Diagram 1	Diagram 2	Diagram 3	Diagram 4	Diagram 5
1.8	2.0	160	5	2628 G-160
2.0	2.5	180	5	2628 G-180
2.5	3.0	200	5	2628 G-200
1.8	2.0	160	5	2628 G-160IP
2.0	2.5	180	5	2628 G-180IP
2.5	3.0	200	5	2628G-200IP

IP: Embalaje industrial



Alicates universales, cromados



2628GC

Faja mm	Diámetro mm	L	Paquetes	Paquetes
2.0	1.8	160	5	2628 GC-160IP
2.5	2.0	180	5	2628 GC-180IP
3.0	2.5	200	5	2628 GC-200IP

IP: Embalaje industrial

Alicates universales, mangos bi-materiales
Filo de corte reforzado



2630GC

Diámetro mm	Faja mm	L	Paquetes	Paquetes
1.8	2.0	160	5	2630GC-160IP
2.0	2.5	180	5	2630GC-180IP
2.5	3.0	200	5	2630GC-200IP

Alicates universales, mangos recubiertos de PVC



2628D

Faja mm	Diámetro mm	L	Paquetes	Paquetes
2.0	1.8	160	5	2628 D-160
2.5	2.0	180	5	2628 D-180
3.0	2.5	200	5	2628 D-200

Alicates universales, mangos recubiertos de PVC
Filos de corte reforzados



2630D

Faja mm	Diámetro mm	L	Paquetes	Paquetes
2.0	1.8	160	5	2630D-160
2.5	2.0	180	5	2630D-180
3.0	2.5	200	5	2630D-200

Alicates universales, modelo americano
Instalador de líneas



2640D

Cu mm	Faja mm	Faja mm	L	Paquetes	Paquetes
3.0	2.7	2.5	160	10	2640D-160
3.0	2.7	2.5	180	5	2640D-180
3.5	3.0	2.5	200	5	2640D-200

Alicates universales para electricista



2688D

Faja mm	Faja mm	Cu mm	L	Paquetes	Paquetes
2.5 mm	3.0 mm	3.5 mm	250	3	2688D-250

Alicates universales



2678G

Fa+ mm	Diámetro mm	L		
1.7	1.3	160	5	2678 G-160
2.0	1.4	180	5	2678 G-180
2.5	1.5	205	5	2678 G-200

Alicate de abertura múltiple



2970 G-200

L	
200	5 2970G-200

ALICATES DE MANIPULACIÓN

Alicate de boca semirredonda



2430G

Cu mm	Fa mm	Fa+ mm	L		
2.5	1.8	1.4	140	5	2430 G-140
3.0	1.8	1.6	160	5	2430 G-160
3.0	1.8	1.6	200	5	2430 G-200
2.5	1.8	1.4	140	5	2430 G-140 IP
3.0	1.8	1.6	160	5	2430 G-160 IP
3.0	1.8	1.6	200	5	2430 G-200 IP

IP: Embalaje industrial

Alicates de boca semirredonda cromado



2430GC

Cu mm	Fa mm	Fa+ mm	L		
2.5	1.8	1.4	140	5	2430 GC-140 IP
3.0	1.8	1.6	160	5	2430 GC-160 IP
3.0	1.8	1.6	200	5	2430 GC-200 IP

IP: Embalaje industrial

Alicates de boca semirredonda, largos, alambre de acero templado



2430G-HD

Cu mm	Diámetro mm	L		
3.0	1.6	190	5	2430 G-190HD

Alicates de boca semirredonda largos, boca recta Mangos recubiertos de PVC



2430D

Cu mm	Fa mm	Fa+ mm	L		
2.5	1.8	1.4	140	5	2430 D-140
3.0	1.8	1.6	160	5	2430 D-160
3.0	1.8	1.6	200	5	2430 D-200
2.5	1.8	1.4	140	5	2430 D-140 IP
3.0	1.8	1.6	160	5	2430 D-160 IP
3.0	1.8	1.6	200	5	2430 D-200 IP

IP: Embalaje industrial



Alicate de boca semirredonda

ergo®



4830, 4831



135	3	4830
135	3	4831

Alicate de boca semirredonda



2656S



132	1	2656 S
-----	---	--------

Alicate de boca redonda



C3830/C3840



121	10	C3830
121	10	C3830IP
144	10	C3840
144	10	C3840IP

IP: Embalaje industrial

Alicates de boca semiredonda



2470G



3.0	1.5	1.0	165	5	2470 G-160
3.0	1.5	1.0	210	5	2470 G-200

Alicate de boca redonda



C3630/C3640



130	10	C3630
130	10	C3630IP
145	10	C3640
145	10	C3640IP

IP: Embalaje industrial

Alicate de boca semirredonda extra largo



158-N



280	12	158-N
-----	----	-------

Alicates de boca semirredonda, punta curva 45°
Para alambre de acero templado

ergo®



2427G

Cu mm	Fe mm	Fe+ mm	L		
3.0	1.8	1.6	160	5	2427 G-160
3.0	1.8	1.6	200	5	2427 G-200
3.0	1.8	1.6	160	5	2427 G-160 IP
3.0	1.8	1.6	200	5	2427 G-200 IP

IP: Embalaje industrial

Alicates de boca semirredonda, punta curva 45° - cromados
Alambre de acero templado

ergo®



2427GC

Cu mm	Fe mm	Fe+ mm	L		
3.0	1.8	1.6	160	5	2427 GC-160IP
3.0	1.8	1.6	200	5	2427 GC-200IP

Alicates de boca semirredonda, punta curva 45°
Alambre de acero - Mangos recubiertos de PVC



2427D

Cu mm	Fe mm	Fe+ mm	L		
3.0	1.8	1.6	160	5	2427 D-160
3.0	1.8	1.6	200	5	2427 D-200

Alicates de boca semirredonda, punta curva 60°

ergo®



4833

L		
130	3	4833

Alicate con punta de aguja, punta curva 45°



C3745

L		
141	10	C3745
141	10	C3745IP

IP: Embalaje industrial

Alicate con punta de aguja, punta curva 90°



C3790

L		
125	10	C3790
125	10	C3790IP

IP: Embalaje industrial



Alicate de manipulación punta curvada 60°



2656R

129	1	2656 R

Alicates de boca semiredonda, curvados



2477G-200

3.0	1.5	1	210	5	2477 G-200

Alicate de boca semicircular extra largo
Con puntas curvadas 35°



158-NB

270	12	158-NB

Alicates de boca plana

ergo®



2420G

125	5	2420 G-125

Alicates de boca plana

ergo®



2421G

140	5	2421 G-140
160	5	2421 G-160
180	5	2421 G-180
140	5	2421 G-140IP
160	5	2421 G-160 IP
180	5	2421 G-180 IP

IP: Embalaje industrial

Alicates de boca plana - cromados

ergo®



2421GC

160	5	2421GC-160
180	5	2421GC-180IP

IP: Embalaje industrial

Alicates de boca plana, mangos recubiertos de PVC



2421D

160	5	2421 D-160
140	5	2421 D-140IP
160	5	2421 D-160IP
180	5	2421 D-180IP

IP: Embalaje industrial

Alicate para conectores



7835G

3.0	1.8	1.6	160	5	7835 G-160

Alicates de boca plana



4430

135	3	4430

Alicate de boca plana



C3430

129	10	C3430
129	10	C3430IP

IP: Embalaje industrial

Alicate de boca plana



2646MF

120	1	2646 MF

Alicates de boca plana



2471G

165	5	2471 G-160



Alicate para tuercas



2979D



180



5 2979 D-180

Alicate de boca redonda, mangos recubiertos de PVC



2521D



140
160



5 2521 D-140
5 2521D-160

Alicate de boca redonda

ergo®



2521G



140
160



5 2521 G-140
5 2521 G-160 IP

IP: Embalaje industrial

Alicates de boca redonda

ergo®



4530



135



3 4530

Alicate de boca redonda, cromado

ergo®



2521GC



160



5 2521GC-160

Alicate de boca redonda



C3530



127
127



10 C3530
10 C3530IP

IP: Embalaje industrial

Alicate de boca semirredonda



2646MS

120	1	2646 MS

TENACILLAS ARTICULADAS

Tenazas articuladas ajustables ERGO™



8223 - 8226

210	4	8223
250	4	8224
315	4	8225
400	1	8226
210	4	8223 IP
250	4	8224 IP
315	4	8225 IP

IP: Embalaje industrial

Tenazas articuladas ajustables ERGO™



8224/8225C

250	4	8224CIP
315	4	8225CIP

Tenacilla articulada ajustable de gran abertura



8231

51	225	5	8231
51	225	5	8231 IP

IP: Embalaje industrial

Tenaza articulada de ajuste rápido con mangos bi-materiales



7223-7225

45	200	8	7223
63	250	4	7224
70	300	4	7225
45	200	8	7223IP
63	250	4	7224IP
70	300	4	7225IP

IP: Embalaje industrial

Tenaza articulada de ajuste rápido con mangos de pvc



7223D

16	200	8	7223D
22	250	4	7224D
25	300	4	7225D



Tenaza de cremallera ajustable con mangos bi-materiales



6224

11	250	4	6224

Tenazas de cremallera ajustables con mangos de PVC



6221D-6225D

6	125	10	6221D
8	150	10	6222D
10	200	8	6223D
11	250	5	6224D
13	300	5	6225D
10	200	8	6223D IP
11	250	5	6224D IP
13	300	5	6225D IP

IP: Embalaje industrial

Tenacilla de ajuste rápido



2971G

35	250	5	2971G-250

Tenacilla de ojal



221 D - 225 D

117	5	221 D
150	5	222 D
192	5	223 D
240	5	224 D
305	5	225 D

Alicate para terminales



2650

65	235	1	2650
	235	1	2650 B

2650 B: Mordaza de plástico para 2650

Juego de 3 tenacillas articuladas



622-3P

110 x 50 x 390 mm	3	1260	1	622-3P

6223D, 6224D, 6225D

Juego de 3 tenacillas articuladas



7224-622XD-3P

75 x 50 x 260 mm	3	813	1	7224-622XD-3P

6221D, 6224D

7224



ALICATES PARA ARANDELAS

Alicates para arandelas interiores



2800

8-13	0.8	140	3	2800-140
12-25	1.2	150	3	2800-150
19-60	1.7	180	3	2800-180
40-100	2.2	225	3	2800-225
85-165	3.1	310	1	2800-300

Alicates para arandelas interiores boca curvada 90°



2890

8-15	0.8	125	3	2890-125
12-25	1.2	140	3	2890-140
19-60	1.7	180	3	2890-180
40-100	2.2	210	3	2890-210
85-165	3.1	300	1	2890-300

Alicates para arandelas interiores



2461

8-25	1.0-2.0	140	1	2461 C8
19-60	2.0-2.5	180	1	2461 C19
40-100	2.5-3.5	255	1	2461 C40

Alicates para arandelas interiores



2463

8-25	1.0-2.0	130	1	2463 D8
19-60	2.0-2.5	170	1	2463 D19
40-100	2.5-3.5	210	1	2463 D40

Alicates para arandelas exteriores



2900





3-10	0.8	140	3	2900-140
10-25	1.2	150	3	2900-150
19-60	1.7	180	3	2900-180
40-100	2.2	215	3	2900-215
85-165	3.1	300	1	2900-300



Alicates para arandelas exteriores bocas curvadas 90°



2990





				
3-10	0.8	125	3	2990-125
10-25	1.2	140	3	2990-140
19-60	1.7	180	3	2990-180
40-100	2.2	200	3	2990-200
85-165	3.1	300	1	2990-300



Alicate para arandelas interiores y exteriores
Puntas intercambiables



2928





				
7-26	3-26	160	1	2928-160
10-51	7-51	200	1	2928-200
46-102	32-102	250	1	2928-250



Alicates para arandelas exteriores



2464



				
3-10	1.0-1.5	120	1	2464 A3
10-25	1.5-2.0	120	1	2464 A10
19-60	2.0-2.5	180	1	2464 A19
40-100	2.5-3.0	210	1	2464 A40



Puntas de repuesto para series 2928







1/4/28

		
2928-160	1	2928-1
2928-200	1	2928-2
2928-250	1	2928-3
2928-250	1	2928-4

Alicates para aranelas exteriores



2466

				
3-10	1.0-1.5	130	1	2466 B3
10-25	1.5-2.0	130	1	2466 B10
19-60	2.0-2.5	165	1	2466 B19
40-100	2.5-3.0	190	1	2466 B40



Alicates para arandelas exteriores



2460

		
175	1	2460



Alicates especiales para arandelas ciegas



2465D

200	1	2465D-200

Juego 4 alicates para arandelas



28-29/S4

740	1	28-29/S4

2900-180		
2800-180		
2990-180		
2890-180		

Juego de alicates para arandelas interiores y exteriores
Puntas intercambiables



9938

1640	1	9938

2928-160, 2928-200, 2928-250		
------------------------------	--	--

PELACABLES Y HERRAMIENTAS PARA DESMONTAJE

Pelacables
Alambre de cobre y cable



2223G

0.5-5	165	5 2223 G-150

Pelacables
Cables de cobre y alambre



2223GC

0.5-5	165	5 2223GC-150

Pelacables
Alambres de cobre y cable



2223D

0.5-5	165	5 2223 D-150



Pelacables automático



3416 A

0,2-6 mm ²	24-10 AWG	1 3416 A 1 3416 A SH

3416 A SH: Hoja de repuesto

Pelacables Coaxial



3417 A

4.8-7.5	110	12 3417 A

Pelacables automático



3416 B

0,02-10 mm ²	34-8 AWG	10 3416 B 10 3416 B SH

3416 B SH: Hoja de repuesto

Pelacables para cables planos y redondos



3517 A

6-13 mm	120	1 3517 A

Pelacables automático



3418 A

20-10 AWG	0,5-6 mm ²	3 mm	160	1 3418 A

Pelacables giratorio
3518ASH hoja de repuesto



3518 A

4-28 mm	185	1 3518 A 1 3518 A SH

3518 A SH: Hoja de repuesto

Pelacables universal con cuchilla retráctil



3518 B

8-13 mm	20-10 AWG	1 3518 B	

Pelacables giratorio



3520 A

0,5-6 mm ²	1 3520 A 1 3520 A SH	

3520 A SH: Hoja de repuesto

Pelacables giratorio



3520 B

4,5-40 mm	10 3520 B 10 3520 B SH	

3520 B SH: Hoja de repuesto

Pelacables de precisión



3619 A

2,5-11 mm	10 3619 A 10 3619 A SH	

3619 A SH: Hoja de repuesto

Pelacables autoajustable estándar



3419 B

0.25-6.00 mm	1 3419 B 1 3419 EB	

3419EB: Cuchilla de repuesto

ALICATES PARA TERMINALES

Alicates para terminales aislados



CR B 01

0.50-6.00	20-10	0.75-6.00	220	5	CR B 01



Alicates para terminales NO aislados



CR B 02



Alicates para terminales tubulares



CR B 06

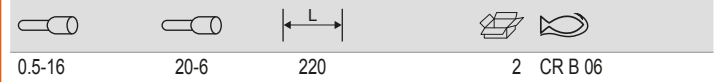

Alicates para terminales no aislados tipo faston



CR B 03



Alicata de carraca desembagable para terminales aislados



CR W 01

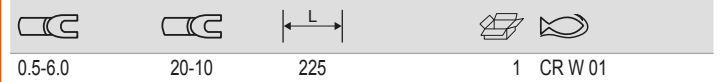

Alicates para terminales tubulares



CR B 05

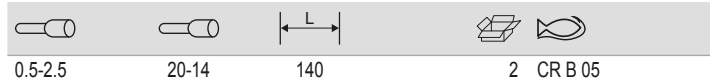

Alicata de carraca desembagable para terminales NO aislados



CR W 02

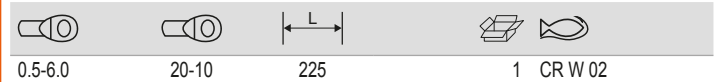

Alicate de carraca desembragable para terminales NO aislados de barril abierto



CR W 03



Alicate de carraca desembragable para terminales tubulares



CR W 06

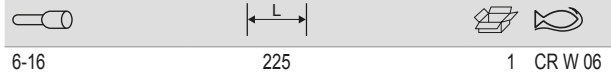

Alicate de carraca desembragable para terminales de cable coaxial BNC-TNC



CR W 04

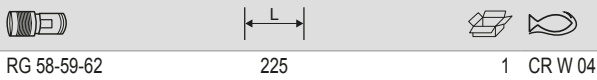

Alicate para engastar terminales de teléfono de 4,6 y 8 polos. Mecanismo bloqueo hasta terminar el engastado



CR W 07



Tres funciones: Corta, pela y engasta
Mecanismo de carraca

Alicate de carraca desembragable para terminales tubulares



CR W 05

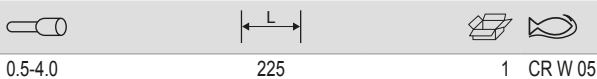

Alicate de carraca desembragable para terminales aislados



CR HL 01



Alicate de carraca desembragable para terminales NO aislados



CR HL 02



Alicate de carraca desembragable para terminales tubulares



CR HL 05

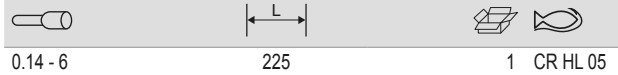

Alicate de carraca desembragable para terminales NO aislados de barril abierto



CR HL 03



Alicate de carraca desembragable para terminales tubulares



CR HL 06

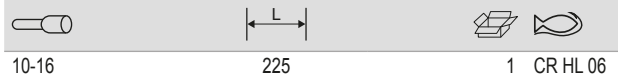

Alicate de carraca desembragable para terminales de cable coaxial BNC-TNC



CR HL 04

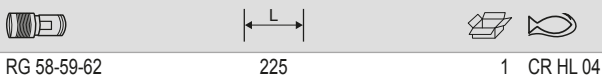

Presna terminales, terminales NO aislados
Terminales y conectores de Cu 10-120mm² (Al 10-95mm²)



CR L 01



Matriz ajustable 9 secciones de compresión

Prensa terminales, terminales no aislados prensado huella hexagonal
Matriz giratoria



CR L 02

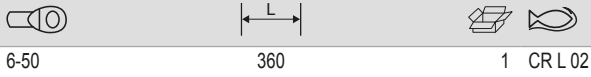

6-50 360 1 CR L 02

Capacidad mm2 6-10-16-25-35-50
No utilizar bajo tensión eléctrica

Prensa terminales, terminales no aislados prensado huella hexagonal



CR L 03

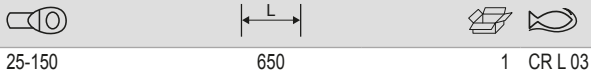

25-150 650 1 CR L 03

Capacidad mm2 25-35-50-70-95-120-150
No utilizar bajo tensión eléctrica

JUEGOS DE ALICATES

Juego de alicates para mecánica de precisión



9733

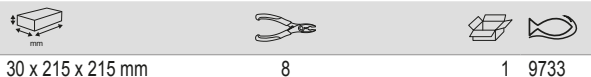

30 x 215 x 215 mm 8 1 9733

4130, 4131	
4239	
4830	
4530	
4231	
4430	
4833	

Juego de 3 alicates de precisión



C3901/3



3 1 C3901/3

C3140IP	
C3640IP	
C3830IP	

Juego de 3 alicates de precisión



C3902/3



3 1 C3902/3

C3330R	
C3840	
C3745	



Juego de llave ajustable y tenacilla

ergo®



9031-8224

2	693	3 9031-8224

9031	
8224	

Pack 2 herramientas para fontanero Llave ajustable y tenaza articulada

ergo®



9873

25 x 190 x 280 mm	2	1 9873

9072 P	
8224	

Juego 3 herramientas Llave ajustable, tenaza articulada y alicate de corte lateral

ergo®



9853

25 x 252 x 292 mm	3	1 9853

9071	
2101G-160	
8224	

Juego de 4 alicates

ergo®



9897

4	1030	1 9897

8224	
2101G-160	
2628 G-180	
2430 G-160	

MORDAZAS Y TENAZAS

Mordaza grip bocas curvas, con cortante



2951

1.2	140	1 2951-140
2	190	1 2951-180
3	235	1 2951-250
4	300	1 2951-300

Mordaza grip, bocas curvas sin cortante



2953

140	1 2953-140
190	1 2953-200
235	1 2953-250
300	1 2953-300

Mordaza grip bocas paralelas



2955



235



1 2955-250

Mordaza grip bocas recta y convexa



2968



205
235



1 2968-190
1 2968-235

Mordaza grip Omnium



2957



250



1 2957-250

Mordaza grip de punta larga y mordaza fina



2952



155
230



1 2952-165
1 2952-235

Mordaza con bocas rectas



2958



135
190
235



1 2958-140
1 2958-200
1 2958-250

Grip con dos bocas autoadaptables



2950



235



1 2950-250



Grip universal, mordazas cortas, 4 posiciones



2997-250



235



1 2997-250

Grip universal, mordazas largas, 4 posiciones



2997



255



5 2997-300

Mordaza grip con sujeción C



2963



283
458
580



1 2963-280
1 2963-450
1 2963-630

Mordaza grip con sujeción C paralela



2964



175
280
436
625



1 2964-160
1 2964-280
1 2964-450
1 2964-600

Mordaza grip para soldadura tipo U



2965



228
290



1 2965-200
1 2965-280

Mordaza grip para tubos



2966



290



1 2966-280

Mordaza grip para planchas de metal



2967



180



1 2967-180

Cortatubo de cadena
2998-SH: cadena de repuesto



2998



240



1 2998-250
1 2998-SH

2998-SH: Cadena de repuesto

Grip de cadena



2999



230



1 2999-250
1 2999-SH

2999-SH: Cadena de repuesto

Tenazas de ajuste rápido



2949



193

196

240

240



1 2949-190IP

1 2949-200IP

1 2949-240IP

1 2949-250IP

Husillo de respuesto: 2949-xxxSH

IP: Embalaje industrial

REMACHADORAS

Remachadora con cabeza giratoria



2681



285



12 2681

Remachadora manual
Capacidad 2,4 -5 mm



1467-250



255



1 1467-250



Alicates de muescas



2690



10 2690

Remachadora de brazos largos
Capacidad: 3 - 6,40 mm



1467-520



530



1 1467-520

Remachadora extensible, mm



1467-320-850



320-850



1 1467-320-850

Respuestos para remachadora 1467



1467



10	1 1467-LJ
10	1 1467-SJ
10	1 1467-L3,2
5	1 1467-S2,4
5	1 1467-L4
5	1 1467-S3,2
5	1 1467-L5
5	1 1467-S4
5	1 1467-L6
5	1 1467-S5
5	1 1467-L6,4
10	1 1467-B14

Juego de repuestos para 2681



2681-1



15

1 2681-1

ALICATES ESPECIALES

Herramienta tensora para abrazaderas de Nylon, tipo pistola



790450A



<2.2x5 mm



1 790450A

Tensa hasta 5mm de ancho y grosor 1,6mm

Herramienta tensora para abrazaderas de Nylon (Bridas)



790455A



<9.5x2.3 mm



1 790455A

Tensa hasta 9,5mm de ancho y grosor 2,3mm

Alicate trenzador



2855



232
287



1 2855
1 2855 D





BAHCO



Llaves para tubos y herramientas para fontanería



LLAVES PARA TUBOS

Llave de tubo de ajuste rápido

ergo®



1610/1620

L	max		
320	1 in	1	1610
430	1 1/2 in	1	1620

10 veces más rápido que el modelo estándar

Tuerca de repuesto para llaves de tubo de ajuste rápido



1610-nut/1620-nut

Ø	g		
11 mm	34	1	1610-NUT
11.5 mm	48	1	1620-NUT

Llave de tubo modelo sueco, 90°

ergo®



1410/1420

L	max		
320	1	1	1410
430	1 1/2	1	1420

Llave para tubo modelo sueco, 90°



140-147

L	max		
210	3/4	1	140
320	1	1	141
426	1 1/2	1	142
557	2 1/2	1	143
722	3 1/2	1	144
1060	5	1	147

Llave de tubo modelo sueco, 90°
Cromada

ergo®



1175

L	max		
320	1	1	1175-1
430	1 1/2	1	1175-11/2

Llave de tubo modelo sueco, 90°



DOW175

L	max		
310	1	1	DOW 175-1
420	1 1/2	1	DOW 175-11/2
560	2	1	DOW 175-2
630	3	1	DOW 175-3

Llave de tubo de esquina, 45°



442 B-444 B

L	max		
320	1	1	442 B
430	2	1	443 B
545	2 1/2	1	444 B

Llave de tubo combinada modelo sueco, 45°



341-344

L	max		
230	1/2	1	341
330	1	1	342
420	1 1/2	1	343
530	2	1	344

Llave de tubo combinada modelo sueco, 45°



DOW177

L	max		
325	1	1	DOW 177-1/2-1
425	1 1/2	1	DOW 177-11/2
534	2	1	DOW 177-2

Llave de tubo de esquina modelo sueco, 45°



DOW176

L	mm	g	Icon
330	1	1	DOW 176-1
415	1 1/2	1	DOW 176-11/2
530	2	1	DOW 176-2

Llave Stillson de aluminio



380

L	mm	g	Icon
253	1.1/2 in	1	380-10
320	2 in	1	380-14
455	2.1/2 in	1	380-18
607	3 in	1	380-24
910	4 in	1	380-36
1210	6 in	1	380-48

Mordaza de repuesto para llaves de pipa de aluminio



8100B

L	mm	g	Icon
380-10	220	1	8100B0100
380-14	430	1	8100B0140
380-18	680	1	8100B0180
380-24	1000	1	8100B0240
380-36	1810	1	8100B0360
380-48	3200	1	8100B0480

Mordaza fija de repuesto para llaves de pipa de aluminio



8100F

L	mm	g	Icon
380-10	30	1	8100F0100
380-14	30	1	8100F0140
380-18	90	1	8100F0180
380-24	180	1	8100F0240
380-36	226	1	8100F0360
380-48	380	1	8100F0480

Tornillo de repuesto para llaves de pipa de aluminio



8100T

L	mm	g	Icon
30	380-10	1	8100T0100
45	380-14	1	8100T0140
70	380-18	1	8100T0180
110	380-24	1	8100T0240
220	380-36	1	8100T0360

Llave Stillson para tubos



361

L	mm	g	Icon
185	1 in	1	361-8
230	1.1/2 in	1	361-10
265	1.3/4 in	1	361-12
315	2 in	1	361-14
450	2.1/2 in	1	361-18
535	3 in	1	361-24
900	4 in	1	361-36

Mordaza de repuesto para llaves Stillson



8060B

L	mm	g	Icon
361-8	80	1	8060B0080
361-10	200	1	8060B0100
361-12	270	1	8060B0120
361-14	330	1	8060B0140
361-18	520	1	8060B0180
361-24	970	1	8060B0240
361-36	1630	1	8060B0360

Tuerca de repuesto para llaves Stillson



8060T

L	mm	g	Icon
20	361-8	1	8060T0080
20	361-10	1	8060T0100
20	361-12	1	8060T0120
40	361-14	1	8060T0140
70	361-18	1	8060T0180
90	361-24	1	8060T0240
250	361-36	1	8060T0360

Llave para tuercas de lavabo



363

L	mm	g	Icon
280	1	1	363-32



Llave de cinta



375

300	1 375-8

Cadena de repuesto para llaves con cadena



3074

340	372-1.1/2	1 307401B
475	372-2.1/2	1 307411B
560	372-4	1 307421B
830	372-6	1 307431B
1000	372-8	1 307441

Abocinador en métrica
8 medidas . 4, 6,8,10,12,14,16 & 18 mm



4480MM

45	4, 6, 8, 10, 12, 14, 16, 18	1 4480MM

Llave de cadena para tubo



370

300	1 370-4

HERRAMIENTAS DE DOBLADO Y CONFORMADO

Dobladora de tubos



500

	1 500-12
	1 500-14
	1 500-15
	1 500-16
	1 500-18
	1 500-22

Abocinador en pulgadas
8 medidas : 3/16", 1/4", 5/16", 3/8", 7/16", 1/2", 5/8" & 3/4"



4480IM

45	5/8, 3/16, 1/4, 5/16, 3/8, 7/16, 1/2, 3/4	1 4480IM

Llaves para tubo de cadena para trabajos pesados



372

1.1	1 372-1.1/2
2.1	1 372-2.1/2
4	1 372-4
6	1 372-6
8	1 372-8
12	1 372-12

Curva-tubos



1084

250	6,8 & 10 mm	5 1084

Juego de abocinador y corta-tubos
Adaptadores: 3/16", 1/4", 5/16", 3/8" y 1/2"



4480/

45 x 140 x 330 mm	1 4480/2-ZD

HERRAMIENTAS DE CORTATUBOS

Cortatubos 16 MM



401-16

3-16 mm	12	401-16

Cortatubos 28 mm



401-28

3-28 mm	12	401-28

Cortatubos 35 mm



402-35

3-35 mm	6	402-35

Cortatubos 76 mm



402-76

12-76 mm	6	402-76

Cortatubos automático



-306

10	1	306-10
12	1	306-12
15	12	306-15
22	12	306-22

Recambio de disco de corte



306-15-95

10	1	306-15-95

Cortatubos de plástico



411

26 mm	4	411-26
35 mm	4	411-35
42 mm	6	411-42
63 mm	5	411-63

Cortatubos para PEX



412-28-PEX

28 mm	5	412-28-PEX

Cortatubos para multicapa



412-26-MULTI

26 mm	5	412-26-MULTI

Hojas de repuesto para tijeras de plástico



411-95

1	39	50	411-26-95
1	37	50	411-35-95
1	41	50	411-42-95
1	48	30	411-63-95



Hojas de repuesto para 412-28-PEX



412-28-PEX-95

1	35	30	412-28-PEX-95

Arandelas/pin para juego 401/402



402-95-SET

30	1	402-95-SET

Hojas de repuesto para 412-26-MULTI



412-26-MULTI-95

1	10	150	412-26-MULTI-95

HERRAMIENTAS DE REBABADO

Rebabador



316-1

143	12	316-1

Rebabador
Hoja de recambio 316-2-95



316-2

150	12	316-2

Rebabador: recambio de 316-2



316-2-95

3	1	316-2-95

Rebabador interno/externo



318-38/318-54

8-38 mm 10-54 mm	1 1	318-38 318-54

Rebabador interno/externo



317-40

3-40 mm	12	317-40



Herramientas neumáticas



LLAVES DE IMPACTO

Llave impacto 3/8" composite



BPC816

	BAR		
12.000	6,3	10	BPC816

Diam. manguera 10mm. Par máx. 583Nm

Llave de impacto neumática 1/2" alta potencia



BP815

	BAR		
8000 min	6,3 bar	1	BPC815

Diam. manguera 10mm. Par máx. 1.112Nm

Llave de impacto neumática 1/2" Rango par 220-360Nm



BP815

	BAR		
7,000	6.3	1	BP815

Diam manguera 10mm
Par máx 825Nm

Llave de impacto neumática compacta 1/2"



BPC814

	BAR		
12000 min	6,3 bar	10	BPC814

Diam. manguera 10mm. Par máx. 678Nm

Llave de impacto neumática compacta 1/2" Rango par 220-360Nm



BP814

	BAR		
10,000	6.3	10	BP814

Diam manguera 10mm
Par máx 410Nm

Mini llave de impacto neumática 1/2"



BPC813

	BAR		
10000 min	6,3 bar	10	BPC813

Diam. manguera 10mm. Par máx. 678Nm

Llave de impacto acodada 1/2"



BP814A

	BAR		
7000 min	6.2 bar	10	BP814A

Juego minillave de impacto con vasos ultra cortos



BPC813K1

1/2 in	65 x 162 x 215 mm	1	BPC813K1

BPC813

K7800M-13, K7800M-14, K7800M-16, K7800M-17, K7800M-19, K7800M-21, K7800M-22, K7800M-24

Juego llave BPC815 con 11 vasos, mm



BPC815K1

1/2 in	90 x 230 x 390 mm	1	BPC815K1

BPC815

K7801M-10, K7801M-11, K7801M-12, K7801M-13, K7801M-14, K7801M-15, K7801M-17, K7801M-19, K7801M-21, K7801M-22, K7801M-24

Juego llave BPC815 con 5 vasos, mm



BPC815K2

1/2 in	90 x 230 x 320 mm	1 BPC815K2

BPC815	
K7801M-13, K7801M-17, K7801M-19, K7801M-22, K7801M-24	

Juego llave BPC815 con 5 vasos, pulgadas



BPC815K3

1/2 in	90 x 230 x 320 mm	1 BPC815K3

BPC815	
K7801Z-1/2, K7801Z-15/16, K7801Z-3/4, K7801Z-5/8, K7801Z-7/8	

Juego llave BPC815 con 5 vasos para ruedas



BPC815K4

1/2 in	90 x 230 x 320 mm	1 BPC815K4

BPC815	
BWSS12P5	

Juego llave BPC815 con 2 vasos para ruedas



BPC815K6

1/2 in	90 x 230 x 320 mm	1 BPC815K6

BPC815	
BWSS12P317, BWSS12P319	

Juego llave BP815 con 11 vasos, mm
 Contiene: Llave Impacto 1/2", 11 vasos impacto (10-24 mm) y conector macho 1/4"



BP815K1

7,000	6.3	1 BP815K1

Juego llave BP815 con soporte y 3 vasos para ruedas
 Contiene: Llave impacto 1/2", Porta vasos magnético y 3 vasos para ruedas (17,19,21 en una caja)



BP815K2

7,000	6.3	1 BP815K2

Llave de impacto de 3/4"
 Rango par 340-950Nm



BP817

4,500	6.3	1 BP817

Diam manguera 10mm
 Par máx 1800Nm

Llave de impacto de composite 3/4"



BPC817

5000 min	6,2 bar	4 BPC817

Juego llave BPC817 con 4 vasos, mm



BPC817K1

3/4" mm	105 x 295 x 390 mm	1 BPC817K1

BPC817	
K8901M-24, K8901M-27, K8901M-30, K8901M-32	



Juego llave BPC817 con 4 vasos, pulgadas



BPC817K2

3/4 in	105 x 295 x 390 mm	1	BPC817K2

BPC817	
K8901Z-1, K8901Z-1.1/16, K8901Z-1.1/8, K8901Z-15/16	

Llave de Impacto de 1" Rango par 1.200-2.700Nm



BP901

	BAR		
3800 min	6.2 bar	1	BP901

Diam manguera 13mm
Par máx 2.800Nm

Llave de impacto de 1", Yunque largo Rango par 1.200-2.700Nm



BP901L

	BAR		
3800 min	6.2 bar	1	BP901L

Diam manguera 13mm
Par máx 2.800Nm

Llave de impacto 1" ligera



BP905P

	BAR		
6000 min	6.2 bar	2	BP905P

Llave de impacto 1" ligera , Yunque corto



BP905S

	BAR		
6.2 bar	6000 min	2	BP905S

Llave de Impacto de 1". Eje largo.



BP905L

	BAR		
6000 min	6.2 bar	2	BP905L

Funda protectora para llave de impacto BPM91BS para ser utilizado con BPM914 y BPM916



BPM91B

85 x 80 x 180 mm	162 g	1	BPM917BOOT

BPM91BS para ser usada con BPM914 y BPM916
BPM91BL para ser usada con BPM915

Juego de silenciadores para llave de impacto BPM91MK1 para ser utilizado con BPM914 y BPM916



BPM91MK

30 x 25 x 25 mm	5 g	1	BPM91MK1
30 x 25 x 50 mm	10 g	1	BPM91MK2

BPM91MK1 para ser usado con BPM914 y BPM916
BPM91K2 para ser usado con BPM915

CARRACAS

Carraca de 3/8" Rango par 0-67Nm



BP820

	BAR		
270	6.3	1	BP820

Diam manguera 10mm

Mini Carraca de 1/4" Rango par 0-30Nm



BP700

	BAR		
300	6.3	20	BP700

Diam manguera 10mm

Carraca de 1/2" Rango par 0-67Nm



BP821

	BAR		
150	6.3	1	BP821

Diam manguera 10mm

Funda protectora para carraca neumática
BP91BS per BP919 e BP920



BP91B

35 x 40 x 60 mm	12	1	BP91BL
30 x 30 x 45 mm	6	1	BP91BS

BP91BS para ser usada con BP919 y BP920
BP91L para ser usada con BP921

AMOLADORAS, LIJADORAS Y PULIDORAS

Mini radial reversible 3" - 75 mm



BP110

	BAR		
18,000	6.3	1	BP110

Diam manguera 10mm

Mini amoladora de bajas revoluciones



BP117

	BAR		
2500	6.3	1	BP117

Diam manguera 10mm

Disco abrasivo, 2 unidades
*Blister con 2 unidades



BP420M

67	25	1	BP420M

Amoladora 6 mm
*Incluye boquilla de 3mm



BP822E

	BAR		
25000	6.3	10	BP822E

Boquillas de 3 y 6mm incluidas

Amoladora Disco 5" - 125mm



BP823

	BAR		
10,000	6.3	1	BP823

Diam manguera 10mm

Mini Amoladora Cabeza Angular 6mm



BP115

	BAR		
20,000	6.3	1	BP115

Boquillas de 3 y 6mm incluidas

Amolador de bajas revoluciones para neumáticos



BP118

	BAR		
2500	6.3	1	BP118

Portamuelas con llave
Conexión giratoria

Disco abrasivo, 2 unidades
* Blister con 2 unidades



BP421M

53	14	1	BP421M

Mini amoladora 6 mm
*Incluye boquilla de 3mm



BP822

	BAR		
25,000	6.3	1	BP822

Boquillas de 3 y 6mm incluidas

Manguera de escape



BP117EH

50 x 100 x 50 mm	1	1	BP117EH

Disco abrasivo, 2 unidades
* Blister con 2 unidades



BP422M

46	26	1	BP422M



Disco abrasivo, 2 unidades
* Blister con 2 unidades



BP423M



53 25 1 BP423M

Disco abrasivo, 2 unidades
* Blister con 2 unidades

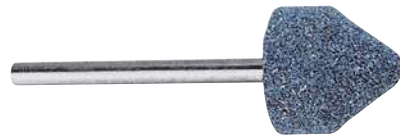

BP432M



44 15 1 BP432M

Disco abrasivo, 2 unidades
* Blister con 2 unidades



BP424M



57 19 1 BP424M

Disco abrasivo, 2 unidades
* Blister con 2 unidades



BP433M



43 14 1 BP433M

Disco abrasivo, 2 unidades
* Blister con 2 unidades



BP430M



55 12 1 BP430M

Disco abrasivo, 2 unidades
* Blister con 2 unidades



BP434M



45 13 1 BP434M

Disco abrasivo, 2 unidades
* Blister con 2 unidades



BP431M



54 13 1 BP431M

Limpiadora de superficies 3.700rpm
19 varillas 3x180 mm



BP127



3700 6.3 1 BP127

Baja vibración

Pulidora angular 7"



BP809



2500 6.3 1 BP809

Mango de goma

Almohadilla de lana 7"



BP80950



178 15 1 BP80950

Pulidora vertical de 7"



BP810



2500 6.3 1 BP810

Juego de lijadora mango pistola



BP204K

	BAR		
15000	6.3	1	BP204K

BP20425180, BP20410800, BP20410320, BP20425220	
BP204	

Almohadillas para lijadora



BP204PAD

77	-	1	BP204PAD

Lijadora de banda 10 mm



BP212

	BAR		
16,000	6.3	1	BP212

Plato para disco lijadora



BP51137

152	x	1	BP51137

Lijadora Orbital 5 mm composite



BP601

	BAR		
152	6.3	1	BP601

Almohadilla de Velcro® incluida

Lijadora con mango de pistola



BP204

	BAR		
15000	6.3	1	BP204

Discos de lija
En juego de 10 piezas o pack de 25



BP204xxyyy

77	1	BP20410320
77	1	BP20410800
77	1	BP20425180
77	1	BP20425220

Lijadora de banda 20 mm



BP222

	BAR		
16,000	6.3	1	BP222

Lijadora Orbital 2.5 mm



BP610

	BAR		
152	6.3	1	BP610

Almohadilla de Velcro® incluida



Paquete de 25 bandas para lijadora de banda



BPN22201/21201

20	1 BPN21201
20	1 BPN22201

TALADROS Y ATORNILLADORES

Taladro reversible 13 mm
Portabrocas rápido



BP825

	BAR	
450	6.3	1 BP825

Diam manguera 10mm
Mango soporte incluido

Atornillador neumático de 1/4"
Par de apriete ajustable externo



BP826

	BAR	
1800	6.3	1 BP826

Rango par 1-10Nm

Atornillador neumático de 1/4"
Par de apriete ajustable externo



BP827

	BAR	
800	6.3	1 BP827

Rango par 1-12Nm

HERRAMIENTAS DE CORTE

Cortadora 4"/102mm de largo alcance



BP111E

	BAR	
15000	6.3	12 BP111E

Sistema bloqueo del disco

Sierra vaivén



BP824

	BAR	
10,000	6.3	1 BP824

Despegador de parabrisas



BP233

	BAR	
20	6.3	1 BP233

Cuchillas rectas
A = Forma plana - B = Forma dentada



BPBG

15	1 BPBG3515
25	1 BPBG3525A
25	1 BPBG3525B

Cuchilla en forma de coma
* Blister con 2 unidades



BPBK

30	1 BPBK30

Rascador
* Blister con 2 unidades



BPBSC

15	1 BPBSC156

Cuchilla en forma de "U"
* Blister con 2 unidades



BPBU

18	1 BPBU18
24	1 BPBU24
36	1 BPBU36
60	1 BPBU60
90	1 BPBU90

Cizalla neumática
Capacidad de corte: 1.6 mm Aluminio/acero 1.2 mm



BP811

	BAR	
2,600	6.3	1 BP811

Capacidad corte: 1.6mm aluminio y 1.2mm acero

Cuchilla acodada 13 mm
* Blister con 2 unidades



BPBG5725/9057

57	1	BPBG5725
90	1	BPBG9057

MARTILLOS, REMACHADORAS Y MARCADORES

Remachadora neumática



BP125

	BAR		
2	6.3	1	BP125

Cinzel giratorio plano 10.2 mm



BP909TF

170	1	BP909TF

Cinzel giratorio plano ancho 10.2 mm



BP909TWF

170	1	BP909TWF

Limpiadora de superficies



BP909AC1

62 mm	1	BP909AC1

Cinzel giratorio cónico 10.2 mm



BP909TTP

165	1	BP909TTP

Cinzel giratorio canto 10.2 mm



BP909TE

139	1	BP909TE

Cinzel giratorio martillo 10.2 mm



BP909TH

108	1	BP909TH

Cinzel giratorio recto 10.2 mm



BP909TSP

165	1	BP909TSP

Cinzel no giratorio plano 10.2 mm



BP909NF

190.5	1	BP909NF

Cinzel no giratorio canto 10.2 mm



BP909NE

173	1	BP909NE



Marcador neumático



BP799

	BAR		
13,000	6.3	1	BP799

Punta del Marcador neumático BP799



BP79912

10	1	BP79912

Pistola de calafateo
Aplicador de cartucho 310 ml



BP215A

BAR		
3.5-4.8 bar	10	BP215A

PISTOLAS DE PINTAR

Pistola para pintar HVLP



BPHVLP01

	BAR		
0.7	2-2.8	1	BPHVLP01

Juego de boquillas
Para ser usada con BPHVLP01



BPHVLP

1.0	1	BPHVLP0110
1.2	1	BPHVLP0112
1.4	1	BPHVLP0114
1.7	1	BPHVLP0117
2.0	1	BPHVLP0120

EQUIPAMIENTO Y ACCESORIOS PARA HERRAMIENTAS NEUMÁTICAS

Soporte magnético para llaves de impacto
Sujeta una llave de impacto, cuatro vasos y una llave dinamométrica



BP500

0.380	1	BP500

Regulador y Filtro de 1/2"
Capacidad 200 cc



BP254

	BAR		
max 3800 L/min	1-8.5	1	BP254

Regulador, Filtro y Lubricador de 1/2"
Capacidad 200 cc



BP255

	BAR		
max 3,800	1-8.5	1	BP255

Lubricador de 1/4"



BPN251

1/4"	0.100	1	BPN251

Manguera espiral de 10 mm



BPH1010

1/4"-1/4" NPT in	10	1	BPH1010A	
1/4"-1/4" BSP in	10	1	BPH1010B	

Carrete enrollador de aire comprimido



BPHRC815/1015



8	15 m	1	BPHRC815
10	14+1 m	1	BPHRC1015

Adaptador opcional de control de velocidad de recogida: BPHRSC

Manguera espiral de 13 mm



BPH1310



1/2"-1/2" in	10	1	BPH1310A
--------------	----	---	----------

Adaptador para enrolladores de manguera



BPHRSC



76 x 88 x 114 mm	1	BPHRSC
------------------	---	--------

Válidos para BPHRC815 y BPHRC1015

Carrete enrollador de aire comprimido



BPHRC1020/1316



10	20 m	1	BPHRC1020
13	15+1 m	1	BPHRC1316

Adaptador opcional de control de velocidad de recogida: BPHRSC

Carrete enrollador de acero



BPHRO1315

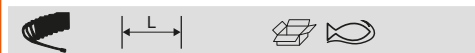

13	13+2	1	BPHRO1315
----	------	---	-----------

Conector rápido hembra de 1/4"
Presión máxima 14 Bar



BPQCF14

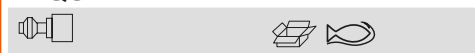

1/4"	10	BPQCF14
------	----	---------

Presión máxima 14 Bar
Flujo de aire 1600 L/min a 6 Bar

HERRAMIENTAS DE SOPLADO Y LIMPIEZA

Pistola de soplado
Boquilla reguladora de presión



BP218



6.3	1	BP218
-----	---	-------

Pistola de soplado



BP219



6.3	1	BP219
-----	---	-------

Toma de latón

Pistola de soplado con boquilla larga de 330mm
Boquilla de 330 mm



BP219L



6.3	1	BP219L
-----	---	--------

Toma de latón

Pistola sopladora y aspiradora



BP219V



6.3	1	BP219V
-----	---	--------

Pistola neumática limpiadora



BPN010



6.2	6000-7500 min ⁻¹	1	BPN010
-----	-----------------------------	---	--------

Limpia (aire & jabón) y seca





BAHCO



Herramienta electro portátil



LLAVES DE IMPACTO

Pistola de impacto 12V 1/4"



BCL31IW1

12	1/4"	1	BCL31IW1

Kit pistola de impacto 12V 1/4"



BCL31IW1K1

110 x 310 x 390 mm	3.1 kg	1	BCL31IW1K1

2x BCL31B1	
BCL31C1	
BCL31IW1	

Pistola de impacto sin escobillas 14,4V 3/8"



BCL32IW1

14.4	3/8"	1	BCL32IW1

Pistola de impacto sin escobillas 14,4V 3/8"



BCL32IW1K1

110 x 310 x 390 mm	3.6 kg	1	BCL32IW1K1

BCL32IW1	
2x BCL32B1	
BCL31C1	

Kit pistola de impacto 18V 1/2" con 2 velocidades/
selector de par



BCL33IW1K1

110 x 310 x 390 mm	5.77 kg	1	BCL33IW1K1

BCL33C1	
BCL33IW1	
2x BCL33B3	

Pistola impacto 18V 1/2" Alto rendimiento sin
escobillas
Hasta 1000 Nm



BCL33IW2

18	1/2"	1	BCL33IW2

Pistola impacto 18V 1/2" con regulación de par
Con 2 selectores de velocidad/par



BCL33IW1

18	1/2"	1	BCL33IW1

Kit pistola impacto 18V 1/22 alto rendimiento
Hasta 1000 Nm



BCL33IW2K1

110 x 310 x 390 mm	6.47 kg	1	BCL33IW2K1

BCL33IW2	
BCL33C1	
2x BCL33B3	

CARRACAS

Carraca 12V 1/4"



BCL31R1

12	1/4"	1	BCL31R1

Kit carraca 12V 1/4"



BCL31R1K1

110 x 310 x 390 mm	3.1 kg	1	BCL31R1K1

2x BCL31B1	
BCL31C1	
BCL31R1	

TALADROS Y ATORNILLADORES

Taladro atornillador 18V 13mm-1/2" sin escobillas y portabrocas automático



BCL33D1

110 x 310 x 390 mm	3.15 kg	1	BCL33D1

Kit taladro atornillador 18V 13mm-1/2" sin escobillas y portabrocas automático



BCL33D1K1

110 x 310 x 390 mm	3.7 kg	1	BCL33D1K1

BCL33C1	
BCL33D1	
2x BCL33B1	

Taladro atornillador 12V 10mm-3/8" con portabrocas automático



BCL31D1

12	360/1550 min	1	BCL31D1

Kit taladro atornillador 12V 10mm-3/8" con portabrocas automático



BCL31D1K1

110 x 310 x 390 mm	3.15 kg	1	BCL31D1K1

2x BCL31B1	
BCL31C1	
BCL31D1	

Atornillador de impacto 12V 1/4"



BCL31IS1

12	1/4" in	1	BCL31IS1

Kit atornillador de impacto 12V 1/4" con kit de cuadrado de liberación rápida



BCL31IS1K1

110 x 310 x 390 mm	3.1 kg	1	BCL31IS1K1

2x BCL31B1	
BCL31IS1	
BCL31C1	

Atornillador 12V 1/4"



BCL31SD1

12	1/4" in	1	BCL31SD1

Kit atornillador 12V 1/4"



BCL31SD1K1

110 x 310 x 390 mm	2.99 kg	1	BCL31SD1K1

BCL31SD1	
2x BCL31B1	
BCL31C1	



AMOLADORAS, LIJADORAS Y PULIDORAS

Lijadora pulidora 14,4V



BCL32SP1

14.4	1900/6900 min	1	BCL32SP1

Pulidora orbital angular 18V



BCL33AP1

18	1100-3500 min	1	BCL33AP1

Kit lijadora pulidora 14,4V



BCL32SP1K1

265 x 290 x 480 mm	3.29 kg	1	BCL32SP1K1

BCL32SP1	
2x BCL32B1	
BCL31C1	

Kit pulidora orbital angular 18V



BCL33AP1K1

265 x 290 x 480 mm	5.78 kg	1	BCL33AP1K1

BCL33AP1	
2x BCL33B3	
BCL33C1	

Amoladora 14,4V 6mm 21000rpm



BCL32DG1

14.4	21000 min	1	BCL32DG1

Kit amoladora 14,4V 6mm



BCL32DG1K1

110 x 310 x 390 mm	3.2 kg	1	BCL32DG1K1

BCL32DG1	
BCL32B1	
BCL31C1	

Kit engrasadora 14,4V



BCL32G1K1

265 x 290 x 480 mm	5.22 kg	1	BCL32G1K1

BCL32G1	
BCL31C1	
2x BCL32B1	

HERRAMIENTAS DE CORTE

Sierra alternativa 14,4V



BCL32RS1

14.4	3000 min	1	BCL32RS1

Kit sierra alternativa 14,4V



BCL32RS1K1

265 x 290 x 480 mm	3.5 kg	1	BCL32RS1K1

BCL32RS1	
2x BCL32B1	
BCL31C1	

ENGRASADORAS

Engrasadora 14,4V



BCL32G1

V 400 1 BCL32G1

Batería de Li-ion de 18V y 2Ah



BCL33B1

V 2 A·h 1 BCL33B1

Cargador de baterías 18V y 2.3A



BCL33C1

V_{in} V_{out} 1 BCL33C1

BATERÍAS Y CARGADORES

Batería de Li-ion de 12V y 2Ah



BCL31B1

V 2 A·h 1 BCL31B1

Batería de Li-ion de 18V y 5Ah



BCL33B3

V 2 A·h 1 BCL33B3

Cargador rápido de baterías 18V y 3,4A



BCL33C2

V_{in} V_{out} 1 BCL33C2

Batería de Li-ion de 14,4V y 2Ah



BCL32B1

V 2 A·h 1 BCL32B1

Cargador dual de baterías 12/14.4V y 3A



BCL31C1

V_{in} V_{out} 1 BCL31C1





BAHCO



Herramientas para automoción



HERRAMIENTAS PARA MOTOR

Juego de calado para motores FCA GROUP 1.4 MULTIAIR



BE501101

68 x 225 x 280 mm 1 BE501101

BE50110101	
BE50110102	
BE50110103	
BE50110104	

Estrangulador de latiguillos



BE256M

40 x 45 x 310 mm 1 BE256M

Juego de calado para FCA Group 0.9 petrol Twinair



BE501102

68 x 225 x 280 mm 1 BE501102

BE50110202	
BE50110203	

Conector R123/R125 Azul



BE400P243

0.06 kg 1 BE400P243

Juego de calado para FCA Group 1.6-1.9-2.0-2.4 diesel



BE501203

68 x 225 x 280 mm 1 BE501203

BE50120301	
BE50120302	
BE50120303	
BE50120305	
BE50110103	

Adaptador Metálico



BE400P2401

65 mm 1 BE400P2401

Adaptador Metálico



BE400P2402

65 mm 1 BE400P2402

Polea de cigüeñal para BMW



BE502104

60 x 98 x 269 mm 1726 g 8 BE502104

Adaptador Metálico



BE400P2403



43.5



1 BE400P2403

Herramienta de sujeción del cigüeñal para BMW



BE502106



80 x 70 x 260 mm



10 BE502106

Juego de calado para FCA Group 1.3 JTD MJ



BE501204



68 x 225 x 280 mm



1 BE501204

BE50120401

BE50120402

BE50120403

BE50120404

BE50120405



Adaptador



BE400P2405



0.065



1 BE400P2405

Adaptador



BE400P2406



0.065



1 BE400P2406

Adaptador



BE400P2407



0.065



1 BE400P2407

Juego de calado para BMW 1.8-2.0 petrol

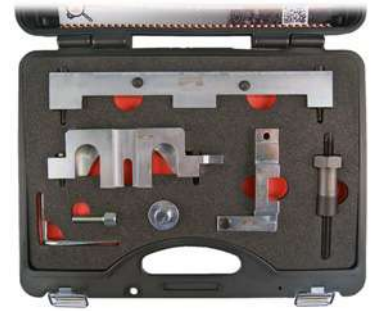

BE502101



95 x 270 x 350 mm



1 BE502101

BE50210101

BE50210102

BE50210103

BE50210104

BE50210105

BE50210106

BE50210107

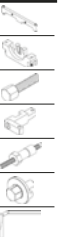

Adaptador



BE400P2409



0.11



1 BE400P2409

Adaptador



BE400P2410



0.085



1 BE400P2410



Juego de calado para BMW 1.6 Petrol

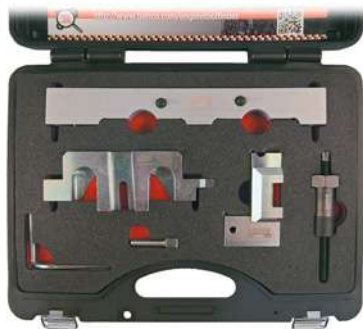

BE502102

270 x 95 x 355 mm	1 BE502102

Juego de calado para BMW 1.6-2.0 petrol

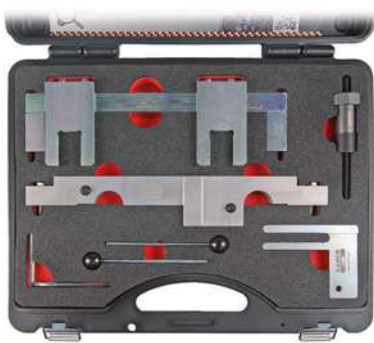

BE502103

80 x 300 x 375 mm	1 BE502103

BE50210301	
BE50210302	
BE50210303	
BE50210305	
BE50210105	
BE50210107	

Juego de calado para BMW 2.0 - 2.5 - 3.0 diesel



BE502204

68 x 225 x 280 mm	1 BE502204

BE50220401	
BE50220403	
BE50220404	
BE50220405	
BE50210305	

Herramientas para bujías, calentadores e inyectores



BE1GP58/BE1GP514

10	70	1 BE1GP58
9	70	1 BE1GP59
10	70	1 BE1GP510
12	70	1 BE1GP512
14	70	1 BE1GP514

Juego de calado para BMW-mini 1.6-2.0 diesel



BE503201

68 x 225 x 280 mm	1 BE503201

BE50320101	
BE50320102	
BE50320103	
BE50320105	
BE50210305	

Juego de calado para MINI-PSA 1.4-1.6 gasolina



BE504102

95 x 270 x 350 mm	1 BE504102

BE50410201	
BE50410202	
BE50410203	
BE50410204	
BE50410206	
BE50210105	

Juego de calado para MINI-PSA 1.6 diesel



BE504201

50 x 50 x 220 mm	1	BE504201

BE50420101	
BE50420102	
BE50420103	
BE50420104	
BE50210305	

Comprobador de calentadores



BE100

160	35 x 65 x 160 mm	1 BE100

Juego de calado para Ford 1.25-1.4-1.6 gasolina



BE505101

68 x 225 x 280 mm	1	BE505101

BE50510101	
BE50510102	
BE50510103	
BE50510104	
BE50510105	
BE50510106	

Juego de reparación de roscado de calentadores



BE1210P11

50 x 120 x 260 mm	1	BE1210P11

Insertos BE1210P9AC1

Equipo para purga y relleno del líquido de refrigeración
BE4101 es un adaptador cónico



BE410

80 x 300 x 375 mm	4	BE410
45 x 45 x 105 mm	1	BE4101

Juego de calado para FORD 1.0 ECOBOOST gasolina



BE505102

95 x 270 x 350 mm	1	BE505102

BE50510201	
BE50510202	
BE50510203	
BE50510204	
BE50420102	
BE50510102	

Set de 5 insertos M8x1



BE1210P110x

M8x1	50	1	BE1210P1101
M10x1	50	1	BE1210P1102
M10x1,25	50	1	BE1210P1103



Juego de limpieza de alojamiento de calentadores
Guía escariador BE1200P6AC1



BE1200P6

50 x 115 x 260 mm	1 BE1200P6	1 BE1200P6AC1

Guía de escariador BE1200P6AC1

Juego de calado para FORD 2.0 - 2.2 - 2.4 Duratorq
TDCI 16v diesel



BE505203

95 x 270 x 350 mm	1 BE505203	

BE50520301	
BE50520302	
BE50520303	
BE50520304	
BE50520305	
BE50520306	
BE50520307	

Kit reparación para alicate BE254



BE2541

100	1 BE2541	

Juego de calado para Ford 1.4-1.6-1.8-2.0-2.2-2.5
diesel



BE505204

95 x 270 x 350 mm	1 BE505204	

BE50520401	
BE50520402	
BE50520403	
BE50520404	
BE50520405	
BE50520407	
BE50520411	
BE50520412	
BE50520413	
BE50510104	
BE50420102	
BE50420103	
BE50420104	
BE50510106	

Juego de calado para Opel 1.0-1.2-1.4 gasolina



BE506101

50 x 50 x 160 mm	1 BE506101	

BE50610101	
BE50610102	
BE50610103	
BE50610104	
BE50610105	

Juego de calado para Opel 1.4-1.6-1.8 gasolina



BE506102

68 x 225 x 280 mm	1 BE506102	

BE50610201	
BE50610202	
BE50610203	
BE50610204	
BE50610205	
BE50610206	

Juego de calado para Opel 1.0-1.2-1.4 Ecoflex gasolina



BE506103

95 x 270 x 350 mm 1 BE506103

- BE50610302
- BE50610304
- BE50610102
- BE50610103
- BE50610105

Juego de calado para Opel 2.0 diesel



BE506204

85 x 300 x 375 mm 1 BE506204

- BE50620401
- BE50620402
- BE50620403
- BE50620404
- BE50620405

Juego de calado para PSA 1.0-1.1-1.4-1.6-1.8-2.0-2.2 gasolina



BE507101

95 x 270 x 350 mm 1 BE507101

- BE50710103
- BE50710104
- BE50710105
- BE50710106
- BE50710107
- BE50710108
- BE50710109
- BE50710110
- BE50710111
- BE50710112
- BE50710101
- BE50710102
- BE50710113
- BE50710114
- BE50710116
- BE50710117
- BE50710118
- BE50710119
- BE50420104

Juego de calado para PSA 1.0-1.2 gasolina



BE507102

68 x 225 x 280 mm 1 BE507102

- BE50710201
- BE50710202

Juego de calado para PSA 1.4-1.5-1.6-1.9-2.0-2.2-2.5 diesel

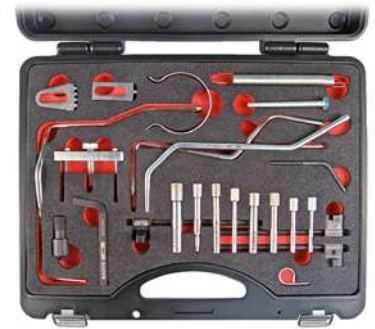

BE507203

85 x 300 x 375 mm 1 BE507203

- BE50720302
- BE50720304
- BE50720305
- BE50720307
- BE50720308
- BE50720310
- BE50720314
- BE50720317
- BE50720318
- BE50720319
- BE50720320
- BE50720321
- BE50720322
- BE50720323
- BE50520404
- BE50520411
- BE50710107
- BE50710104
- BE50710113
- BE50710110
- BE50710102
- BE50710106
- BE50420102
- BE50420103



Juego de calado para Renault/Dacia 1.2-1.4-1.6-1.8-2.0 gasolina

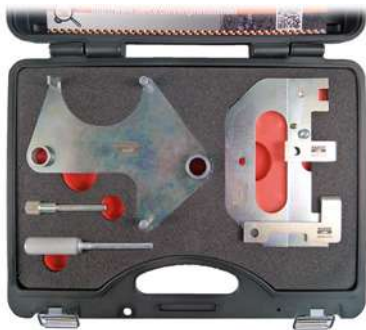

BE508101

95 x 270 x 350 mm	1 BE508101

BE50810101	
BE50810103	
BE50810104	
BE50810106	

Alicates desconexión de combustibe



BE1FLD1/BE1FLD3

8 mm	1 BE1FLD1
10 mm	1 BE1FLD2
8-10 mm	1 BE1FLD3

Juego de calado para Renault 1.5-1.9-2.2-2.5 diesel



BE508202

80 x 300 x 375 mm	1 BE508202

BE50820201	
BE50820202	
BE50820203	
BE50820204	
BE50820205	
BE50820206	
BE50820207	
BE50820208	
BE50820209	
BE50820211	
BE50810103	
BE50810104	

Juego de alicates para desconexión de conductos de combustible de 8 y 10mm



BE1FLDS

8-10	1 BE1FLDS

BE1FLD1, BE1FLD2, BE1FLD3

Juego de calado para Renault 2.0 diesel



BE508203

68 x 225 x 280 mm	1 BE508203

BE50820301	
BE50820302	
BE50820303	
BE50820304	
BE50210305	

Extractor universal de aforador de combustible



BE1FTW

75-160	1 BE1FTW

Juego de calado para Renault -Nissan 1.6 diesel



BE508204



95 x 270 x 350 mm

1 BE508204

BE50820402

BE50820403

BE50820404

BE50820302

Llave de filtro de combustible para Ford 2.2TDCi



BE1FFWF



5 x 142 x 169 mm

12 BE1FFWF

Juego de calado para VW Group 1.4-1.6-1.8-2.0 gasolina



BE509101



80 x 300 x 375 mm

1 BE509101

BE50910101

BE50910102

BE50910103

BE50910104

BE50910105

BE50910106

BE50910107

BE50910108

BE50910109

BE50910110

BE50910111

BE50910112

BE50910114

BE50520302

Juego de calado para VW Group 1.2-1.4-1.6 gasolina



BE509102



68 x 225 x 280 mm

1 BE509102

BE50910201

BE50910202

BE50910203

BE50910205

BE50910206

BE50910207

BE50520302

Juego de calado para VW Group 1.2 TSI gasolina



BE509103



50 x 50 x 210 mm

1 BE509103

BE50910302

BE50910203

Juego de calado para VW Group 1.0 gasolina



BE509104



68 x 225 x 280 mm

1 BE509104

BE50910401

BE50910402

BE50910403

BE50910404

BE50910203

Juego de calado para VW Group 1.2-1.4-1.6-1.9-2.0 diesel



BE509205



60 x 60 x 220 mm

1 BE509205

BE50910103

BE50920602

BE50920603



Juego de calado para VW Group 1.9-2.0 diesel



BE509206

60 x 60 x 220 mm 1 BE509206

- BE50920602
- BE50910103
- BE50920703

Juego de calado para VW Group 1.2-1.4-1.6-1.9-2.0 diesel

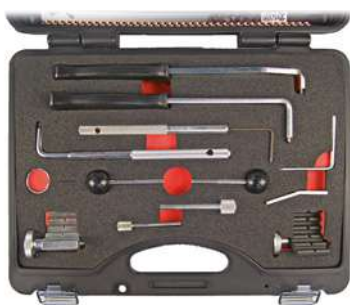

BE509207

95 x 270 x 350 mm 1 BE509207

- BE50920703
- BE50920707
- BE50920708
- BE50920709
- BE50920710
- BE50910103
- BE50910112
- BE50920602
- BE50920603
- BE50910109
- BE50510102

Juego de calado para VOLVO 1.6 - 1.8 - 1.9 - 2.0 - 2.3 - 2.4 - 2.5 gasolina



BE510101

60 x 60 x 355 mm 1 BE510101

- BE51010101
- BE51010102
- BE51010103

Juego de calado para VOLVO 1.6 - 1.8 - 2.0 16v. gasolina



BE510102

50 x 50 x 220 mm 1 BE510102

- BE51010201
- BE51010202
- BE50510102
- BE50510105
- BE50510106

Juego de calado para VOLVO 1.6 - 2.0 diesel



BE510203

68 x 225 x 280 mm 1 BE510203

- BE50420102
- BE50420103
- BE50420104
- BE50520407
- BE50520411
- BE50510104

Crankshaft pulley holding tool for Volvo



BE510304

50 x 145 x 265 mm 1 BE510304

Juego de calado para SAAB 1.8i gasolina



BE511101

50 x 50 x 220 mm 1 BE511101

- BE51110101
- BE51110102
- BE50610201
- BE50610204

Juego de calado para SAAB 1.6t gasolina



BE511102

50 x 50 x 207 mm 1 BE511102

BE50610201	
BE50610202	
BE50610205	
BE50610203	

Juego de calado para SAAB 1.9 - 2.0 - 2.2 Tid diesel



BE511203

80 x 300 x 375 mm 1 BE511203

BE51120301	
BE51120302	
BE51120303	
BE51120304	
BE51120305	
BE50120302	
BE50120303	
BE50120305	
BE50610201	

Jgo Extracción Bujías M8-M9-M10
M8x1 - M9x1 - M10x1 - M10x1.25



BE513201

95 x 270 x 350 mm 2.10 1 BE513201

BE51320101	
BE51320102	
BE51320103	
BE51320104	
BE51320105	
BE51320106	
BE51320107	
BE51320108	
BE51320109	
BE51320110	
BE51320111	
BE51320112	
BE51320113	
BE51320114	

Mango amarre de poleas universal



BE523106

0.41 1 BE523106

Tensímetro de correas



BE239

38 x 82 x 95 mm 95 mm 1 BE239

Grosor de correa 2-8mm

Tensiómetro digital de correas



BE240

60 x 270 x 315 mm 315 mm 1 BE240

Unidad de medida; Herzios

Libro de datos de valores de tensión para la sincronización y correas accesorias, sincrónica, V & V y forma acanalada.



BE240-CAT

710 1 BE240-CAT



Util de cambios de correa sin tensor
Rango diámetros de polea: 80-350mm



BE230



35 x 145 x 155 mm



1 BE230

Juego extractor polea alternador
24 piezas



BE500P24



55 x 270 x 370 mm



- 1 BE500P24
- 1 BE500P2401
- 1 BE500P2402
- 1 BE500P2403
- 1 BE500P2404
- 1 BE500P2405
- 1 BE500P2406
- 1 BE500P2407
- 1 BE500P2408
- 1 BE500P2409
- 1 BE500P2410
- 1 BE500P2411
- 1 BE500P2412
- 1 BE500P2413
- 1 BE500P2414
- 1 BE500P2415
- 1 BE500P2416
- 1 BE500P2417
- 1 BE500P2418
- 1 BE500P2419
- 1 BE500P2420
- 1 BE500P2421
- 1 BE500P2422
- 1 BE500P2423
- 1 BE500P2424

Juego de 6 leznas



2633HD/S6



- 80 x 270 x 375 mm
- 42 x 93 x 290 mm
- 30 x 85 x 215 mm
- 30 x 93 x 200 mm
- 20 x 87 x 165 mm
- 10 x 60 x 120 mm
- 10 x 10 x 155 mm



- 1 2633HD/S6
- 1 2633HD1
- 1 2633HD2
- 1 2633HD3
- 1 2633HD4
- 1 2633HD5
- 1 2633HD6

Alicate para abrazaderas elásticas
12-55mm



BE258



12-55



285



1 BE258

Termómetro infrarrojos
Rango medición: -50°C +550°C



BLT550



-50 +550



40 x 95 x 145 mm



10 BLT550

Campo: 12:1
Precisión: ±1.5% o ±1.5 °C

Refractómetro



3046-REF



150



1 3046-REF

Comprobador anticongelante
-35° hasta -0°



BE401



50 x 50 x 235 mm



235 mm



1 BE401

Juego de herramientas para reparación de A/A 12
pzas



BE800P12



43 x 90 x 200 mm



1 BE800P12

Lámpara UV



BLUVF

450	70 x 98 x 295 mm	1	BLUVF

Longitud de onda UV 405nm

Juego para soltar conectores rápidos



BAC007

240 mm	0.075 kg	1	BAC007

Medidas: 1/4", 5/16", 3/8", 1/2", 5/8", 3/4", 7/8"

Juego de 6 vasos acanalados



BE5500

10/11/12/14/17/19	25	BE5500

Juego para línea de combustible 7 piezas



BE257

68 x 225 x 280 mm	8	BE257
	1	BE25710
	1	BE25718
	1	BE2572
	1	BE2576

Kit universal de extracción de inyectores



BE512201

140 x 415 x 600 mm	1	BE512201

BE51220101	
BE51220102	
BE51220103	
BE51220104	
BE51220105	
BE51220106	
BE51220107	
BE51220108	
BE51220109	
BE51220110	
BE51220111	
BE51220112	
BE51220113	
BE51220114	
BE51220115	
BE51220116	
BE51220117	
BE51220118	
BE51220119	
BE51220120	

Comprobador de bombas de tensión con galgas



BE400P241

BAR	PSI		
0-2,5 bar	0-36 psi	1	BE400P241

Juego de extractores de inyectores



BE1311P13

80 x 355 x 445 mm	1	BE1311P13

Juego de vasos para inyectores diesel, 25-27-29-30 mm



BE1310P4

68 x 225 x 225 mm	1	BE1310P4



Juego de 5 vasos articulados para calentadores bi-hex universal
Cuadrado 1/4"- 8,9,10,12 y 14mm



BE1GP5

1/4"	110 x 240 x 40 mm	1	BE1GP5

BE1GP510, BE1GP512, BE1GP514, BE1GP58, BE1GP59

Llave de plástico para radiador



BE400P2420

0.005 kg	1	BE400P2420

Vaso impacto 1/2" para extraer inyectores diesel



BE1310P425-BE1310P430

25	1/2	1	BE1310P425
27	1/2	1	BE1310P427
29	1/2	1	BE1310P429
30	1/2	1	BE1310P430

Motores Bosch, Siemens, PSA HDI (2.0)

Mango en T para calentadores



BE1GP5-T

1/4"	400	10	BE1GP5-T

Extractor de calentadores



BE1205

130	35 x 35 x 130 mm	1	BE1205

Válido para calentadores de 9 y 10mm

Juego para rectificar asientos de inyectores



BE1315P7

68 x 225 x 280 mm	1	BE1315P7
25 x 180 x 275 mm	1	BE1315P71
20 x 93 x 175 mm	1	BE1315P72
19 x 93 x 140 mm	1	BE1315P73
16 x 93 x 140 mm	1	BE1315P74
20 x 56 x 96 mm	1	BE1315P75
20 x 56 x 96 mm	1	BE1315P76
23 x 56 x 96 mm	1	BE1315P77

Martillo deslizando



BE1300SH

235	50 x 50 x 235 mm	10	BE1300SH

Cable para alicates BE253, BE254 y BE255



BE2542

630 mm	20 g	1	BE2542

Juego de 3 alicates para latiguillos



BE256P3

40 x 93 x 330 mm	1	BE256P3
15 x 55 x 155 mm	1	BE256-155
20 x 45 x 185 mm	1	BE256-178
10 x 55 x 250 mm	1	BE256-250

Desmontador de asiento de válvula de inyectores DENSO





BE1310DNS

36.4 x 24 x 24 mm    12 BE1310DNS

Extractor de arandelas de cobre de inyectores



BE1300

230 mm  35 x 35 x 260 mm    1 BE1300

Set Válvula Lapper



BE762

30 x 90 x 315 mm    12 BE762

Juego de arandelas de cobre para inyectores



BE1305P450

40 x 140 x 205 mm    1 BE1305P450

Alicate de sirga para abrazaderas EGR





BE253

870    1 BE253

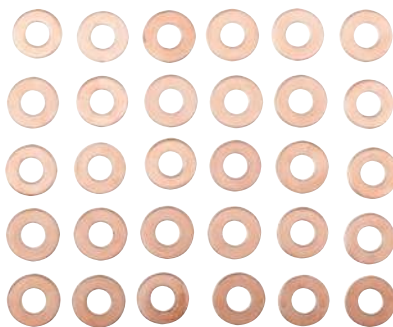
Set de 30 arandelas de cobre para inyectores



BE1305P450B

  1 BE1305P450WS01
1 BE1305P450WS02
1 BE1305P450WS03



- 1 BE1305P450WS04
- 1 BE1305P450WS05
- 1 BE1305P450WS06
- 1 BE1305P450WS07
- 1 BE1305P450WS08
- 1 BE1305P450WS09
- 1 BE1305P450WS10
- 1 BE1305P450WS11
- 1 BE1305P450WS12
- 1 BE1305P450WS13
- 1 BE1305P450WS14
- 1 BE1305P450WS15

Alicate para abrazaderas 45°
Cabeza angulada y mordazas giratorias



BE250

190  245    1 BE250

Alicate pinza para abrazaderas elásticas



BE251

210  180    1 BE251

Mandíbulas con cabeza giratoria



Comprobador de retorno de inyección en motores common rail



BE5350

84 x 341 x 447 mm	5	BE5350
10 x 56 x 96 mm	1	BE5350C1
10 x 56 x 96 mm	1	BE5350C2
10 x 56 x 96 mm	1	BE5350C3
10 x 56 x 96 mm	1	BE5350C4
115 x 65 x 205 mm	1	BE5350C5

Bomba para tarar inyector y circuitos diesel



BE13ZL11

480 x 230 x 280 mm	4.24	1	BE13ZL11

Vasos especiales para inyección Diesel 27mm - 1/2"



7807

29	80 mm	1	7807

Juego de 8 vasos con punta Torx® Plus inviolables (pentabolulares) Cuadradillo 1/4"



BE5008

40 x 20 x 175 mm	1	BE5008

TR+10,15,20,25,27,30,40,45

BE5008-10, BE5008-15, BE5008-20, BE5008-25, BE5008-27, BE5008-30, BE5008-40, BE5008-45

Vasos 1/4" Torx® Plus Inviolables



BE5008-10/BE5008-45

10	1	BE5008-10
15	1	BE5008-15
20	1	BE5008-20
25	1	BE5008-25
27	1	BE5008-27
30	1	BE5008-30
40	1	BE5008-40
45	1	BE5008-45

Alicates para bujías



BE1P

290	20 x 50 x 290 mm	1	BE1P

Vasos para bujías, cuadrado 3/8", magnético Hexagonal, mm y pulgadas



7406ZZ

16	65 mm	1	7406ZZ-16
21	68 mm	1	7406ZZ-21

Vasos para bujías, cuadrado 1/2" Hexagonal, en mm



7805ZZ

16	67 mm	1	7805ZZ-16
21	69 mm	1	7805ZZ-21

Termómetro



BE400P244

0.02	1	BE400P244

Juego de 9 vasos de 1/2 con punta RIBE, adecuado para motores



BE5102

65 x 225 x 225 mm	1	BE5102

BE510210, BE510211, BE510212, BE510213, BE51025, BE51026, BE51027, BE51028, BE51029

Compresímetro para motores diesel



BE5401D

105 x 325 x 410 mm	1	BE5401D

Bar 0-69
PSI 0-1000

Adaptador



BE400P2404

0.055	1	BE400P2404

Vaso de 1/2" con punta RIBE



BE51025-BE510213

RM5	100	1	BE51025
RM6	100	1	BE51026
RM7	100	1	BE51027
RM8	100	1	BE51028
RM9	100	1	BE51029
RM10	100	1	BE510210
RM11	100	1	BE510211
RM12	100	1	BE510212
RM13	100	1	BE510213

Vaso para bujías, cuadrado 3/8" Hexagonal, en mm



SBS71

16	60 mm	1	SBS71-16
21	65 mm	1	SBS71-21

Llave para bujías 3/8"



BE1SP14L

3/8"	252 mm	1	BE1SP14L

Adaptador



BE400P2408

0.075	1	BE400P2408

Juego de 6 vasos de 1/2 con punta XZN, adecuado para motores



BE5103

65 x 225 x 225 mm	1	BE5103

BE510310, BE510312, BE510314, BE51035, BE51036, BE51038



Llaves para bujías, articulación cardan



BE1T14/BE1T16/BE1T21

Ø	L	Icon	Icon
14	65/310	1	BE1T14
16	63/450	1	BE1T16
21	67/450	1	BE1T21

Adaptador



BE400P2411

kg	Icon	Icon
0.11	1	BE400P2411

Vasos de 1/2" con punta XZN



BE51035-BE510314

Icon	L	Icon	Icon
M5	140 mm	1	BE51035
M6	140 mm	1	BE51036
M8	140 mm	1	BE51038
M10	140 mm	1	BE510310
M12	140 mm	1	BE510312
M14	140 mm	1	BE510314

Cepillo para limpiar bujías



52

L	Icon	Icon
150	12	52

Adaptador



BE400P2412

kg	Icon	Icon
0.085	1	BE400P2412

Cepillo multi-uso



782-U

L	Icon	Icon
285	1	782-U

Adaptador



BE400P2413

kg	Icon	Icon
0.065	1	BE400P2413

Cepillo para limpiar discos de freno



783

L	Icon	Icon
223	1	783

Adaptador



BE400P2414

kg	Icon	Icon
0.11	1	BE400P2414

Cepillo para terminales



2555

L	Icon	Icon
85	1	2555

Adaptador para comprobar sistema de refrigeración



BE400P2415

0.075 kg	1	BE400P2415

Kit de reparación de roscas para bujías



BE110001

60	1	BE110001

Kit de reparación de roscas para bujías
BE110015 / Arandela: M14 x 1,25P - M15,8 x 1,25P



BE110014/BE110015

55	1	BE110014
55	1	BE110015

Kit de reparación de roscas de bujías



BE1100

68 x 225 x 280 mm	1.55	8	BE1100

Adaptador



BE400P2417

0.11	1	BE400P2417

Kit de reparación de roscas para bujías



BE1100AC1/BE1100AC2

15	1	BE1100AC1
15	1	BE1100AC2

Adaptador



BE400P2416

0.065	1	BE400P2416

Adaptador



BE400P2418

0.045	1	BE400P2418

Adaptador



BE400P2419

0.075	1	BE400P2419



Juego para el control del circuito de refrigeración



BE400P24

127 x 435 x 510 mm	1	BE400P24

Juego de puntas de 10mm
32 piezas



BE5032

65 x 225 x 225 mm	1	BE5032

BE5049M5, BE5049M6, BE5049M8, BE5049M10, BE5049M12, BE5032M14		
BE5049T20, BE5049T25, BE5049T27, BE5049T30, BE5049T40, BE5049T45, BE5049T50, BE5049T55, BE5049T60		
BE5049H5, BE5049H6, BE5049H8, BE5049H10, BE5049H12, BE5032H14		
BE5032SQ8, BE5032SQ10		
BE5049H6L, BE5049H8L		
BE5049T45L		
BE5049M8L, BE5049M10L, BE5049M12L		
BE5032H10EL		
x BE5032T55EL		
x BE504901		

Caja 5 Puntas Robertson de 10 mm



BE5032SQ

#8	30	1	BE5032SQ8
#10	30	1	BE5032SQ10

Juego de Puntas 10mm
49 pzs



BE5049

55 x 190 x 320 mm	3.56	5	BE5049

Adaptador 1/2" para puntas 10 mm



BE504901

10	36 mm	1	BE504901

Caja 5 Puntas hexagonales, 10mm



BE5049H

4	30	1	BE5049H4
5	30	1	BE5049H5
6	30	1	BE5049H6
7	30	1	BE5049H7
8	30	1	BE5049H8
10	30	1	BE5049H10
12	30	1	BE5049H12
14	30	1	BE5032H14

Caja 5 Puntas XZN, 10mm



BE5049M





M5	30	1	BE5049M5
M6	30	1	BE5049M6
M8	30	1	BE5049M8
M10	30	1	BE5049M10
M12	30	1	BE5049M12
M14	30	1	BE5032M14

Caja 5 puntas TORX®, 10 mm



BE5049T





T20	30	1	BE5049T20
T25	30	1	BE5049T25
T27	30	1	BE5049T27

			
T30	30	1	BE5049T30
T40	30	1	BE5049T40
T45	30	1	BE5049T45
T50	30	1	BE5049T50
T55	30	1	BE5049T55
T60	30	1	BE5049T60

Caja 5 Puntas Torx® inviolable, 10mm



BE5049T

			
TR20	30	1	BE5049T20H
TR25	30	1	BE5049T25H
TR27	30	1	BE5049T27H
TR30	30	1	BE5049T30H
TR40	30	1	BE5049T40H
TR45	30	1	BE5049T45H
TR50	30	1	BE5049T50H
TR55	30	1	BE5049T55H
TR60	30	1	BE5049T60H

Juego de 9 vasos de 1/2 con punta TORX®, inviolables



BE5101



		
65 x 225 x 225 mm	1	BE5101

BE510125, BE510127, BE510130,
BE510140, BE510145, BE510150,
BE510155, BE510160

Comprobador de presión de aceite motor







BE5200

		
85 x 355 x 445 mm	1	BE5200
25 x 105 x 195 mm	1	BE530001
	1	BE52001
	1	BE52002
	1	BE52003

Tenaza para segmentos



BE74-55100/BE74-80120

			
55-100	20 x 130 x 205 mm	1	BE74-55100
80-120	20 x 145 x 220 mm	1	BE74-80120

Desmontador de válvulas para vehículo industrial
Capacidad 90-280mm



BE76105

		
70 x 315 x 380 mm	1	BE76105

Conector R123/R124 Negro



BE400P242

		
0.035	1	BE400P242

Adaptador de 3/8" para puntas de 10 mm







BE504902

			
10	28 mm	1	BE504902

Caja 5 Puntas hexagonales, 10mm
Serie larga 75mm



BE5049H

			
4	75	1	BE5049H4L
5	75	1	BE5049H5L
6	75	1	BE5049H6L
7	75	1	BE5049H7L
8	75	1	BE5049H8L
10	75	1	BE5049H10L
10	115	1	BE5032H10EL
12	75	1	BE5049H12L



Caja 5 Puntas XZN, 10mm serie larga 75mm
Serie larga 75mm



BE5049M

	L		
M5	75	1	BE5049M5L
M6	75	1	BE5049M6L
M8	75	1	BE5049M8L
M10	75	1	BE5049M10L
M12	75	1	BE5049M12L

Caja 5 puntas TORX® 10 mm, serie larga
Long series 75mm



BE5049T

	L		
T20	75	1	BE5049T20L
T25	75	1	BE5049T25L
T27	75	1	BE5049T27L
T30	75	1	BE5049T30L
T40	75	1	BE5049T40L
T45	75	1	BE5049T45L
T50	75	1	BE5049T50L
T55	75 mm	1	BE5049T55L
T55	115	1	BE5032T55EL

Caja 5 Puntas TORX® invariable, 10mm
Serie larga 75mm

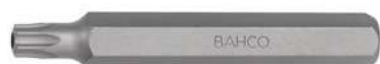

BE5049T

	L		
TR20	75	1	BE5049T20HL
TR25	75	1	BE5049T25HL
TR27	75	1	BE5049T27HL
TR30	75	1	BE5049T30HL
TR40	75	1	BE5049T40HL
TR45	75	1	BE5049T45HL
TR50	75	1	BE5049T50HL
TR55	75	1	BE5049T55HL
TR60	75	1	BE5049T60HL
TR70 mm	100 mm	1	BE5049T70HL
TR80 mm	70 mm	1	BE5049T80HL
TR30 mm	200 mm	1	BE5049T30HXL
TR40 mm	200 mm	1	BE5049T40HXL
TR45 mm	200 mm	1	BE5049T45HXL

Juego puntas TORX 49 piezas



BE5049t

	kg		
55 x 190 x 320 mm	3.54 kg	1	BE5049T

Vasos de 1/2" con punta TORX® invariables



BE510125-BE510160

	L		
TR25	100 mm	1	BE510125
TR27	100 mm	1	BE510127
TR30	100 mm	1	BE510130
TR40	100 mm	1	BE510140
TR45	100 mm	1	BE510145
TR50	100 mm	1	BE510150
TR55	100 mm	1	BE510155
TR60	100 mm	1	BE510160

Juego para retenes de cigüeñal y árbol de levas



BE5150P27

80 x 270 x 375 mm		1	BE5150P27
56 x 56 x 96 mm		1	BE5150P271
80 x 80 x 195 mm		1	BE5150P272
170 x 160 x 385 mm		1	BE5150P273

Compresímetro para motores de gasolina



BE5400P

70 x 160 x 260 mm		1	BE5400P

Ceñidor de segmentos de pistón



BE74-57125/BE74-90175

	L		
80	57-125	1	BE74-57125
105	90-175	1	BE74-90175
62	57-125	1	BE74-57125L

Alicate desmontador de válvulas



BE76101

40 x 200 x 290 mm		1	BE76101

Juego para el reemplazo de juntas



BE700

90 x 200 x 43 mm	1 BE700	
	1 BE700BP2	
	1 BE700SP15	

Alicate para abrazaderas OETIKER™



BPOC15

275	12 BPOC15	

Llaves en T con puntas hexagonales



BE1TH

2 mm	15	10	BE1TH-2
2,5 mm	20	10	BE1TH-2.5
3 mm	23	10	BE1TH-3
3,5 mm	23	10	BE1TH-3.5
4 mm	60	10	BE1TH-4
4,5 mm	60	10	BE1TH-4.5
5 mm	60	10	BE1TH-5

6 mm	127	10	BE1TH-6
7 mm	205	10	BE1TH-7
8 mm	205	10	BE1TH-8
9 mm	385	10	BE1TH-9
10 mm	385	5	BE1TH-10
12 mm	571	5	BE1TH-12
14 mm	801	5	BE1TH-14

Juego de 6 llaves en T con puntas hexagonales, 2,5-3-4-5-6-8mm



BE1TH-S6

6	30 BE1TH-S6

BE1TH-2.5, BE1TH-3, BE1TH-4, BE1TH-5, BE1TH-6, BE1TH-8

Llaves en T con vaso giratorio



BE1TS

6 mm	475	10	BE1TS-6
7 mm	475	10	BE1TS-7
8 mm	485	10	BE1TS-8
9 mm	475	10	BE1TS-9
10 mm	485	10	BE1TS-10
11 mm	485	10	BE1TS-11
12 mm	475	10	BE1TS-12
13 mm	485	10	BE1TS-13
14 mm	485	10	BE1TS-14
15 mm	485	10	BE1TS-15
16 mm	495	10	BE1TS-16
17 mm	495	10	BE1TS-17
18 mm	510	10	BE1TS-18
19 mm	495	10	BE1TS-19
20 mm	730	8	BE1TS-20
21 mm	765	8	BE1TS-21
22 mm	745	8	BE1TS-22
24 mm	745	8	BE1TS-24

Juego de 7 llaves en T con vaso giratorio, 7-8-10-12-13-14-17mm

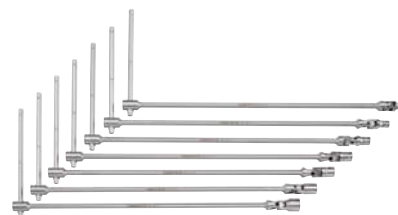

BE1TS-S7

7	6 BE1TS-S7

BE1TS-7, BE1TS-8, BE1TS-10, BE1TS-12, BE1TS-13, BE1TS-14, BE1TS-17

Soporte para motores 500kg



BH8AC2-500

	A		
500	937 mm	1	BH8AC2-500



HERRAMIENTAS PARA SISTEMAS DE ESCAPE

Extractor de humos de accionamiento neumático
Tubo interior extensible de 2.5m dentro de la carcasa de Aluminio



BUCPE

300 mm	1263 x 306 x 300 mm	1 BUCPE
105 mm	15 x 105 x 105 mm	1 BUCPEF1
121 mm	60 x 121 x 121 mm	1 BUCPEF

Opcional: Manguito extensible de 3m (BUCPE3SH)
y tubo doble de escape (BUCPE3SDH)

Tubo doble de escape para BUCPE
3m de largo



BUCPE3SH

3000 mm	63,5 mm	1 BUCPE3SH

Manguito extensible de 3mm para BUCPE
3m de largo



BUCPE3SDH

420 x 530 x 3000 mm		1 BUCPE3SDH

Alicate universal para escapes
Apertura máx 60mm



BUC50

65	305	1 BUC50

Alicate para desmontaje de escapes



BUC110

360 mm	50 x 65 x 360 mm	1 BUC110

Separador tramos de escape universal
Rango de trabajo 34-54 mm



BUC100

34-54	320 mm	1 BUC100

Tester de sensor lambda
Pruebas lambda Zirconia (0-1 V) y Titania (0-5 V)



BELT10

35 x 65 x 160 mm		1 BELT10

Vaso especial para servicio sonda Lambda
22mm - 1/2"



7806

22	83 mm	1 7806

HERRAMIENTAS Y EQUIPAMIENTOS PARA CAMBIOS DE ACEITE

Llave de fleje



BE611

65-105	25 x 55 x 210 mm	1 BE61110
65-105	1 x 12 x 382 mm	100 BE61110-1
100-155	37 x 75 x 275 mm	1 BE61155
100-155	1 x 12 x 529 mm	1 BE61155-1

Llave de fleje para filtros de aceite con mango de goma



BE62

65-105 mm	42.5 x 57 x 249 mm	10 BE62110
110-155 mm	42.5 x 85 x 314 mm	10 BE62155

Llave de filtro de cadena y cadenas de repuesto



BE64520/BE64350

L			
350	60-105	1	BE64350
350	60-105	1	BE64350CH
520	60-160	1	BE64520
520	60-160	1	BE64520CH

Llave de cinta universal



BE66152

150	28 x 90 x 225 mm	6 BE66152
150 mm	95 x 170 x 220 mm	8 BE661521

Cinta de repuesto disponible: BE661521
Capacidad: hasta 150mm

Llave de filtro 3 garras planas
Adaptador 1/2" a 3/8" incluido



BE65F65120

3/8"	65-120	12 BE65F65120

Extractores de filtro 3 patas magnético



BE65R

3/8-1/2"	65-120	1 BE65R65120
3/8-1/2"	80-119	1 BE65R80120
1/2"	105-160	1 BE65R106160

Juego de cazoletas para filtros de aceite
28 extractores, 1 llave filtros y 3 garras



BE630

87 x 505 x 610 mm	3 BE630

Aceiteras
BOD4200: 200 ml



BOD4200/BOD4500

0.2	158 x 86 x 128 mm	1 BOD4200
0.5	158 x 86 x 128 mm	1 BOD4500

Cazoletas para filtro individuales



BE630

66 mm	Fiat, Renault	1 BE630666F
64 mm	Daihatsu, Fiat, Nissan, Toyota	12 BE6306514F
65-66 mm	Daihatsu, Toyota	12 BE630656714F
66 mm	Ford, Mazda, Subaru	1 BE6306814F
73 mm	Alfa Romeo, Lexus, Toyota	1 BE6307314F
74 mm	Audi, Chrysler, GM, Rover	1 BE6307415F
74-76 mm	Audi, Ford, Mercedes Benz, Opel, VW	12 BE630747615F
74-75 mm	Audi, Ford, Isuzu, Mercedes Benz, Opel, VW	1 BE630757715F
76 mm	Fiat, Mercedes Benz, Renault	12 BE6307612F
74 mm	Audi, BMW, Mercedes Benz, Opel, Porsche, VW	12 BE6307614F
74 mm	Ford	1 BE6307630F
74 mm	Fiat, Lancia	1 BE630768F
78 mm	Ford, Honda, Nissan, Toyota	1 BE6307815F
80 mm	Honda, Isuzu, Mazda, Nissan, Opel, Subaru, Toyota	1 BE6308015F
80-82 mm	Acura, Honda, Mazda, Nissan, Subaru, Toyota	1 BE630808215F
86 mm	Volvo	1 BE6308616F
86 mm	Audi, Citroen, Peugeot, Renault, VW	1 BE6308618F
89 mm	Honda, Isuzu, Mitsubishi	1 BE6309015F
92 mm	Fiat, Lancia	1 BE6309210F
92 mm	Audi, Ford, Honda, Mazda, Mitsubishi, Nissan, Opel, Porsche, Renault, Volvo, VW	1 BE6309315F
93 mm	Ford	1 BE6309336F
93 mm	Audi, VW	1 BE6309345F
95 mm	Alfa Romeo, Chrysler, Ford, Toyota	1 BE6309515F
96 mm	Audi, Renault, VW	1 BE6309618F
101 mm	Isuzu, Mitsubishi	25 BE63010015F
24 mm	BMW	50 BE630246F
106 mm	Fiat, MAN, Scania	1 BE63010615F
27 mm	Mercedes Benz	50 BE630276F
107 mm	Volvo	1 BE63010815F
32 mm	GM, Mercedes Benz, Opel, Saab	50 BE630326F
108 mm	Renault	1 BE63010818F
36 mm	BMW, Ford, Mercedes Benz, Opel, Rover, VW	100 BE630366F
38 mm	BMW, Opel, Volvo	50 BE630386F
66.5 mm	Daihatsu, Toyota	25 BE63066514F



Llave de filtro de aceite de 27 mm para Ford y Grupo PSA



BE6302712F

1/2 mm	27 mm	5	BE6302712F

Cazoleta para filtros de aceite 74 mm 14 caras



BE6307414F

14	1	10	BE6307414F

Juego de 17 vasos para cambio de aceite



BE6217

55 x 105 x 220 mm	1	BE6217

Llave para filtro de aceite para Toyota, Lexus, Subaru, Daihatsu con 4 cilindros (1,8 a 2,0L)



BE63064514F1

Toyota, Lexus, Subaru, Daihatsu 4 cilindros (1.8-2.0l)	64.5 mm	1	BE63064514F1

Llave para tapón de carter con sección cuadrada



BE68

8	235	1	BE68
8 x 10	270	1	BE6810
BE68: Cuadrado 8mm			
BE6810: Cuadrado 8-10mm			

Vasos para cambio de aceite de 3/8"



Llave para filtro de aceite para Toyota, Lexus, Subaru, Daihatsu con 4, 6 o 8 cilindros (2,5L a 5,7L)



BE63064514F2

64.5 mm	Toyota, Lexus, Subaru, Daihatsu 4, 6, 8 cilindros (2.5-5.7L)	1	BE63064514F2

Extractor bomba sumidero 1/4" VW-AUDI



BE6701VAG

10 x 50 x 125 mm	0,02 kg	1	BE6701VAG

BE621701-BE621717

#	mm		
6	8	1	BE621701
6	9	1	BE621702
6	10	1	BE621703
6	12	1	BE621704
6	13	1	BE621705
6	14	1	BE621706
6	17	1	BE621707
4	8	1	BE621708
4	9.5	1	BE621709
4	10	1	BE621710
4	10.5	1	BE621711
4	11	1	BE621712
4	12	1	BE621713
4	13.1	1	BE621714
4	10	1	BE621715
3	10	1	BE621716
xZN	M16	1	BE621717

Juego de tapones y arandelas para cárter



BOD10P64

68 x 225 x 280 mm	1	BOD10P64

Juegos de tapones y arandelas para cárter



BOD10

34 x 93 x 105 mm	1	BOD101
35 x 95 x 105 mm	1	BOD102
33 x 93 x 105 mm	1	BOD103
33 x 93 x 105 mm	1	BOD104
33 x 93 x 105 mm	1	BOD105
95 x 105 x 35 mm	1	BOD106

Juego tapones y arandelas



BOD10XNWS

M13x1.25	1	BOD101NWS
M13x1.5	1	BOD102NWS



M15x1.5	1	BOD103NWS
M17x1.5	1	BOD104NWS
M20x1.5	1	BOD105NWS
M22x1.5	1	BOD106NWS

Aspiroil aspiradora de aceite



BOD8902

1000 x 413 x 632 mm	1	BOD8902

Recogedora de aceite por gravedad y aspiración, con cámara de visualización 90L



BOD8903A

1700 x 419 x 608 mm	1	BOD8903A

Recogedora de aceite por gravedad, 90L



BOD8901

1000 x 413 x 630 mm	32	1	BOD8901

Embudo extensible para Aspiroil



BOD8901AC1

620 x 620 x 150 mm	1	BOD8901AC1

Equipo de llenado de cambios automáticos



BOD6080P12

595 x 255 x 330 mm	1	BOD6080P12

Tanque 8L



Adaptador para juego BOD6080P12



BOD6080P12-01



35

1 BOD6080P12-01

Adaptador para juego BOD6080P12



BOD6080P12-05



25

1 BOD6080P12-05

Adaptador para juego BOD6080P12



BOD6080P12-09



15

1 BOD6080P12-09

Adaptador para juego BOD6080P12



BOD6080P12-02



55

1 BOD6080P12-02

Adaptador para juego BOD6080P12



BOD6080P12-06



25

1 BOD6080P12-06

Adaptador para juego BOD6080P12



BOD6080P12-10



85

1 BOD6080P12-10

Adaptador para juego BOD6080P12



BOD6080P12-03



45

1 BOD6080P12-03

Adaptador para juego BOD6080P12



BOD6080P12-07



45

1 BOD6080P12-07

Adaptador para juego BOD6080P12



BOD6080P12-11



105

1 BOD6080P12-11

Adaptador para juego BOD6080P12



BOD6080P12-04



6

1 BOD6080P12-04

Adaptador para juego BOD6080P12



BOD6080P12-08



45

1 BOD6080P12-08

Embudo 1,2L
1200 cc



BOD301200



225 x 165 x 165 mm

1 BOD301200

Recogedora de aceite
8L



BOD2008

8	115 x 325 x 590 mm	1	BOD2008

Recogedora de aceite
16 L



BOD1016

16	170 x 450 x 570 mm	1	BOD1016

Macho roscado para tapón de aceite
Dimensiones: M13 x 1.25



BOD10XT

B	C		
28 mm	13	1	BOD101T
32 mm	13	1	BOD102T
32 mm	15	1	BOD103T
42 mm	17	1	BOD104T
42 mm	20	1	BOD105T
38 mm	22	1	BOD106T

Envase de 2L con boca flexible



BOD2FS

2	330 x 130 x 380 mm	20	BOD2FS

Bomba de Barril rotativa
Barris 50-205 L com rosca de 1"



BOD70

230 x 250 x 1330 mm	1	BOD70

Bomba de trasvase para 50-205L con conexiones 1/2" y 2"
16 l/min



BOD60

875 x 57 x 245 mm	1	BOD60

Bomba de engrase profesional



BOD5HD400

60 x 115 x 360 mm	1	BOD5HD400

Bomba de engrase universal



BOD5400/BOD5450

55 x 120 x 390 mm 65 x 125 x 385 mm	1 1	BOD5400 BOD5450

Manguera flexible de alta resistencia para bombas de engrase



BOD54-1 / -2

4.1 4.1	10.8 10.8	1 1	BOD54-1 BOD54-2

Boquilla para engrasadoras



BOD54-3

37	1	BOD54-3

Presión máx 500Bar



HERRAMIENTAS Y EQUIPOS PARA SISTEMAS DE FRENADO

Juego de 9 vasos de 1/2" con punta TORX® de impacto para frenos
9 piezas



BBR203P9

68 x 225 x 225 mm 1 BBR203P9

BBR203P920, BBR203P925, BBR203P927, BBR203P930, BBR203P940, BBR203P945, BBR203P950, BBR203P955, BBR203P960

Vasos impacto Torx® 1/2" para frenos



BBR203P920-BBR203P960

Tamaño	Longitud	Cantidad	Código
T20	78 mm	1	BBR203P920
T25	78 mm	1	BBR203P925
T27	78 mm	1	BBR203P927
T30	78 mm	1	BBR203P930
T40	78 mm	1	BBR203P940
T45	78 mm	1	BBR203P945
T50	78 mm	1	BBR203P950
T55	78 mm	1	BBR203P955
T60	78 mm	1	BBR203P960

Juego de 6 vasos de 1/2 de impacto XZN para frenos



BBR201P6

68 x 225 x 225 mm 8 BBR201P6

BBR201P64014, BBR201P64016, BBR201P64018, BBR201P67814, BBR201P67816, BBR201P67818

Vasos impacto 1/2" con punta XZN



BBR201P64014-BBR201P67818

Tamaño	Longitud	Cantidad	Código
M14	40 mm	1	BBR201P64014
M16	40 mm	1	BBR201P64016
M18	40 mm	1	BBR201P64018
M14	78 mm	1	BBR201P67814
M16	78 mm	1	BBR201P67816
M18	78 mm	1	BBR201P67818

Juego de vasos de 1/2 de perfil pentagonal, para freno de mano



BBR202P4

43 x 90 x 200 mm 1 BBR202P4
1 BBR202P410
1 BBR202P414

3 vasos 10,14 y 19mm
1 vaso con punta 10mm

Juego para extracción e instalación de muelles de freno



BBR210P3

80 x 270 x 375 mm 1 BBR210P3
25 x 59 x 182 mm 1 BBRS210P
75 x 270 x 350 mm 1 BBRS210P2

Tenaza para muelles de freno con cabeza oscilante



BBR6135

335 1 BBR6135

Alicate para muelles de freno



BBR6131

210 1 BBR6131

Comparador con soporte magnético



1154

230 x 50 x 75 mm 1 1154

1154-DG

1154-MB

Reloj comparador



1154-DG

0-10 0.01 1 1154-DG

Rango medición: 0-10mm
Incremento medición: 0,01mm

Base magnética



1154-MB

70 x 96 x 297 mm 230 + 150 1 1154-MB

Calibre de aluminio



BBR400

6 x 89 x 120 mm 1 BBR400

Calibre para discos y tambores de freno.



BBR410

20 x 210 x 280 mm 0.610 kg 24 BBR410

Reposicionador neumático pistones de frenos Cuadrado 3/8"



BBR320

3/8" 1/4" 1 BBR320

Abocinador



BBRFKM1

141 x 115 x 195 mm 1551 12 BBRFKM1

Set para calibre de frenos universal de 50 piezas Cuadrado de 3/8"



BBR300P50

82 x 350 x 425 mm 5.56 1 BBR300P50

Calibre digital para discos de freno



BBR420

0-60 mm 35 x 104 x 176 mm 50 BBR420



Juego galgas para pastillas de freno



BBRPTG1

68	300 x 125 x 125 mm	10 BBRPTG1

Tester para líquido de frenos, en pluma



BBR100

20 x 20 x 150 mm	1 BBR100

Comprobador líquido de frenos DOT 3/4/5/5.1



BBR110

35 x 65 x 160 mm	1 BBR110

Purgador de frenos



BBR350

1/4" 300 x 125 x 125 mm	1 BBR350

Purgador electrico de frenos 12V



BBRBB12

895 x 390 x 395 mm 14.6 kg	1 BBRBB12

Juego de adaptadores para tapones de líquido de frenos



BBRAS14

PN5 in 85 x 350 x 445 mm	4 BBRAS14

Herramientas de mantenimiento del sistema de monitorización de la presión de los neumáticos



BWTMPSS9

68 x 225 x 225 mm	1049	8 BWTMPSS9

Herramientas de mantenimiento del sistema de monitorización de la presión de los neumáticos



BWTVCTT355

0.45 Nm	0.33 lb-ft	1 BWTVCTT355

Medidor de presión de neumáticos



BWTPG1

20 x 90 x 394 mm	10 BWTPG1

Tapones de deflación de la boquilla del neumático



BWTMSS4C

TPMS

27 x 59 x 108 mm	60	25	BWTMSS4C

HERRAMIENTAS PARA RUEDAS Y TRANSMISION

Vaso impacto 17mm para Mercedes



BWSMB17

17 mm	1	BWSMB17

Útil para rótulas de dirección



BS54

57 x 57 x 70 mm	1	BS54

Capacidad de 33-42mm

Vaso de impacto para ruedas, 15mm



BWSMB15

TPMS

15 mm	25	BWSMB15

Juegos de vasos para ruedas



BWSS

17, 19, 21 mm 45 x 125 x 145 mm	20	BWSS12P3

Juego para extracción e instalación de rodamientos



BT20P26

150 x 310 x 535 mm	1	BT20P26

Vaso de impacto antirrobo de 21 mm para Hyundai y KIA



BWSHK21

1/2" in 21 mm	25	BWSHK21

BWSS12P317, BWSS12P319, BWS-
S12P321

Barra de torsión de impacto 1"



BZWTB

32	450	1	BZWTB0132450
32	600	1	BZWTB0132600
33	600	1	BZWTB0133600

Juego de vasos para ruedas 1/2"
Contenido: 17, 19, 21, 22, 24 mm



BWSS12P5

17, 19, 21, 22, 24 mm 175 x 240 x 50 mm	1	BWSS12P5

BWSS12P317, BWSS12P319,
BWSS12P321, BWSS12P522, BWS-
S12P524



Vasos específicos para automoción



BWSS12P

mm	mm		
1/2 mm	17 mm	1	BWSS12P317
1/2 mm	19 mm	1	BWSS12P319
1/2 mm	21 mm	1	BWSS12P321
1/2 mm	22 mm	1	BWSS12P522
1/2 mm	24 mm	1	BWSS12P524

Set 5 barras de torsión



BWTB12P5

mm	kg		
68 x 225 x 280 mm	1.74 kg	1	BWTB12P5

BWTB12P100, BWTB12P110, BWTB12P120, BWTB12P135, BWTB12P90

Juego vasos impacto 1/2" para ruedas

Contenido: 17, 19 y 22mm



BWSS12PL

mm	mm		
1/2 in	17 mm	1	BWSS12P317L
1/2 mm	19 mm	1	BWSS12P319L
1/2 mm	21 mm	1	BWSS12P321L

Barra de torsión



BWTB1290-BWTB12P200

L	Nm		
200	100 Nm	1	BWTB12P100
200	110 Nm	1	BWTB12P110
200	120 Nm	1	BWTB12P120
200	135 Nm	1	BWTB12P135
200	150 Nm	1	BWTB12P150
200	160 Nm	1	BWTB12P160
200	175 Nm	1	BWTB12P175
200	190 Nm	1	BWTB12P190
200	200 Nm	1	BWTB12P200
200	90 Nm	1	BWTB12P90

Vaso largo torsión 1/2" 150mm



BWTS317L-BWTSP321L

mm	mm		
1/2 in	17	1	BWTS317L
1/2 in	19	1	BWTSP319L
1/2 in	21	1	BWTSP321L

Juego de machos y terrajas



BWHTRS12

mm	g		
225 x 67 x 225 mm	1350	15	BWHTRS12

Juego vasos para tuercas redondeadas



BWTSP6

mm			
55 x 105 x 217 mm	1	BWTSP6	

BWTSP617, BWTSP619, BWTSP621, BWTSP622, BWTSP624

Vasos para tuercas redondeadas



BWTSP617-BWTSP624

mm	mm		
17	1/2 in	1	BWTSP617
19	1/2 in	1	BWTSP619
21	1/2 in	1	BWTSP621
22	1/2 in	1	BWTSP622
24	1/2 in	1	BWTSP624

Juego de 7 vasos para ruedas



BWTSP7

--	--

52 x 117 x 207 mm

1 BWTSP7

Vasos específicos para automoción



BWTSP16

--	--

48 x 125 x 245 mm

1 BWTSP16

Vasos para ruedas



BWTSP

--	--

8	3/8" mm	1 BWTSP1608
10	3/8" mm	1 BWTSP1610
11	3/8" mm	1 BWTSP1611
12	3/8" mm	1 BWTSP1612
13	3/8" mm	1 BWTSP1613
14	3/8" mm	1 BWTSP1614
16	3/8" mm	1 BWTSP1616

17	3/8" mm	1 BWTSP1617
18	3/8" mm	1 BWTSP1618
19	3/8" mm	1 BWTSP1619
21	1/2" mm	1 BWTSP1621
22	1/2" mm	1 BWTSP1622
24	1/2" mm	1 BWTSP1624
27	1/2" mm	1 BWTSP1627
32	1/2" mm	1 BWTSP732
36	3/4" mm	1 BWTSP736
41	3/4" mm	1 BWTSP741

Juego de vasos largos torsión 1/2", 17, 19 y 21mm



BWTSP3L

--	--

68 x 225 x 150 mm

1 BWTSP3L

BWTSP317L, BWTSP319L, BWT-SP321L

Vasos de impacto de pared fina, 1"



BHVIS12 / BHVIS06

12	68	1 BHVIS1265
6	70	1 BHVIS0670
6	77	1 BHVIS0677
6	80	1 BHVIS0680
6	85	1 BHVIS0685
6	90	1 BHVIS0690
6	95	1 BHVIS0695
6	100	1 BHVIS06100
6	105	1 BHVIS06105

Vasos de impacto 3/4", 8 caras



BHVIS08

3/4 mm	95	1 BHVIS0895
3/4 mm	100	1 BHVIS08100
3/4 mm	115	1 BHVIS08115
	109	1 BHVIS109BPW12
	120	1 BHVIS120BPW16

Vasos de impacto para BPW



BHVISxxBPW

	111	1 BHVIS111BPW12
3/4" mm	80	1 BHVIS80BPW12
3/4" mm	95	1 BHVIS95BPW9

Husillo hidráulico 12Tn



BWHEHS

12	265-282	1 BWHEHS

Avance 17mm



Plato extractor de cubos de ruedas con husillo hidráulico



BWHEPS

12	#4-5 / 116-135	1	BWHEPS

- BWHEP
- BWHEHS

Juego vasos de impacto para ruedas 17, 19 y 21mm



BWSS12P3L

17, 19, 21 mm	68 x 225 x 225 mm	1	BWSS12P3L

- BWSS12P317L, BWSS12P319L, BWSS12P321L

Plato extractor de bujes



BWHEP

#4-5 / 116-135	90 x 147 x 147 mm	1	BWHEP

Martillo de inercia 5Kg



BWSH5

100 x 100 x 985 mm	2	BWSH5

Martillo de inercia 8Kg



BWSH8

960 x 100 x 100 mm	1	BWSH8

Compuesto por martillo 5Kg (BWSH5) + Adaptador M18
+Maza adicional 3Kg (BSSHE3)

- BWSH5
- BWSH51
- BSSHE3

Maza de 3Kg



BSSHE3

60	100	1	BSSHE3

Adaptador M18



BWSH51

M38	M18x38	1	BWSH51

Plato extractor de cubos de ruedas con martillo deslizante



BWHEPSH8

#4-5 / 116-135	960 x 150 x 150 mm	1	BWHEPSH8

Plato extractor de cubos de ruedas



BWHEPSSH8

12 t / 265-282 mm	#4-5/116-135	1	BWHEPSSH8

Juego de vasos de impacto de 1/2" para tuercas de bujes



BT15P5

60 x 85 x 255 mm	1	BT15P5
2 Vasos Hex: 14 y 17mm		
3 Vasos Bihex: 24, 30, 32mm		

Vaso de impacto de 1/2" bihexagonales



BT15P524-BT15P532

1/2"	24	1	BT15P524
1/2"	30	1	BT15P530
1/2"	32	1	BT15P532
1/2" mm	36	1	BT15P536

Llaves en cruz



29-B/BWXW1/BWXW2

S		
17,19,21	1/2"	1 29-B
17,19,22	1/2"	1 BWXW1
24,27,32	3/4"	1 BWXW2
17, 19, 21, 22	-	1 BWXW3
24, 27, 32, 38	-	1 BWXW4

Juego colocación/extracción de bujes y rodamientos de ruedas



BWB14

80 x 300 x 525 mm	1	BWB14

Set para extraer e instalar de cojinetes hidráulicos



BT20P49

164 x 520 x 890 mm	1	BT20P49

Juego de extractores de rótula con husillo hidráulico 12t



BWHPJ12

12	70 mm	4 BWHPJ12

Kit de reparación BS52 39-52mm



BS5228-BS523945

28-34 mm	1	BS5228341
34-40 mm	1	BS5234401
39-35 mm	1	BS5239451

Vaso extractor de rótulas grupo PSA



BS100PSA1

56	52	1 BS100PSA1

Extractor de rótulas, para barras y bielas de dirección



BS6

A		
21	400 mm	1 BS618
26	400 mm	1 BS623



Kit de preparación de abrazaderas



BE2512005

5	12	1 BE2512005

Alicate para abrazaderas



BE251200

170	1 BE251200

Expansor neumático de guardapolvos



BPCVB1

25-110 mm	138 x 138 x 455 mm	6 BPCVB1

Kit de preparación de abrazaderas



BE2512008

8	15	1 BE2512008

Herramienta para soltar y apretar rótulas axiales



BS52

110 x 315 x 380 mm	3,08 kg	1 BS52

VW T4 Herramienta para reemplazo de juntas



4594VWT4

245 x 112 x 320 mm	5 4594VWT4

Desmontador de neumáticos



38-8 - 38-24

200	5 38-8
300	5 38-12
400	5 38-16
500	2 38-20
600	1 38-24

Pinza equilibrado de ruedas



BWP150

20 x 87 x 255 mm	1 BWP150

Desmontador de neumáticos, curvado



39-24

605	1 39-24

Desmontador de neumáticos



38A

304	1 38A-12
382	25 38A-15
537	1 38A-21
655	1 38A-26

Medidor digital de profundidad de neumático



BWTDG1

0 - 25 mm	30 x 76 x 156 mm	50	BWTDG1

Desmontador Neumaticos Curvado



38C

645	1	38C-26

Juego de tres palancas articuladas



BT10P3

80 x 270 x 375 mm	1	BT10P3
250mm (BT10P325); 300mm(BT10P330)		
380mm (BT10P338)		

Palanca articulada



BT10P325-BT10P338

250	40	BT10P325
300	1	BT10P330
375	1	BT10P338

La cabeza se puede ajustar en 14 posiciones

Centrador de embragues



BE310

68 x 225 x 280 mm	1.14	8 BE310

HERRAMIENTAS Y EQUIPOS PARA SUSPENSION

Compresor de muelles para Macpherson



BS15

125 x 425 x 510 mm	1	BS15
43 x 110 x 160 mm	1	BS15125
165 x 160 x 385 mm	1	BS15125C
42 x 160 x 160 mm	1	BS15160

42 x 160 x 170 mm	1	BS15160C
42 x 160 x 212 mm	1	BS15212
24 x 160 x 215 mm	1	BS15212C
45 x 56 x 95 mm	1	BS1550

Desmontador mecánico de amortiguadores



BS10MEC

1180 x 500 x 625 mm	66.2	1 BS10MEC

Palanca para brazo de suspensión
10 diferentes posiciones



BS20

35 x 210 x 1225 mm	5.08	1 BS20

Mango aislado



Plato/Adaptador para amortiguadores de vehículos deportivos con anilla de regulación
Para ser usado con BS10 y BS10MEC



BS10AC2

400 x 400 x 200 mm	1	1	BS10AC2

Desmontador neumático de amortiguadores
(la base es el B10 actualizado)



BS30

1180 x 500 x 625 mm	1	BS30

Extensión de altura móvil



BS30AC1

336 x 545 x 450 mm	1	BS30AC1

Juego universal extractor de copelas de suspensión
39 pzs



BS1000

70 x 405 x 575 mm	1	BS1000
	1	BS100001
	1	BS100002
	1	BS100003
	1	BS100004
	1	BS100005
	1	BS100006
	1	BS100007
	1	BS100008
	1	BS100009
	1	BS100010
	1	BS100011
	1	BS100012
	1	BS100013
	1	BS100014
	1	BS100015
	1	BS100016
	1	BS100017
	1	BS100018
	1	BS100019
	1	BS100020
	1	BS100021
	1	BS100022
	1	BS100023
	1	BS100024
	1	BS100025
	1	BS100026
	1	BS100027
	1	BS100028
	1	BS100029
	1	BS100030
	1	BS100031
	1	BS100032
	1	BS100033
	1	BS100034
	1	BS100035
	1	BS100036
	1	BS100037
	1	BS100038
	1	BS100039

Util para brazo de suspensión



BS25

20 Nm	200	70	BS25

Panel protector para vehículos



BBS50

890	590	1	BBS50

HERRAMIENTAS PARA BATERÍAS Y SISTEMAS ELÉCTRICOS

Adaptador USB/Micro USB para BBL12-400



BBL12-40001

8 x 100 x 180 mm	10	1	BBL12-40001

Cargador de coche 12V para BBL12-400



BBL12-40002

25	1	BBL12-40002

Booster 12 / 24 V 1.700 / 900 CA



BBA1224-1700

V	CA		
12/24	1700/900	1	BBA1224-1700

Batería para boosters 12V



BB1200A

V		
12 V	1	BB1200A

Batería litio fosfato 12V 8Ah



BBL800A

V			
12 V	8 A-h	1	BBL800A

Booster para industria pesada, 12/24V



BBA1224-3200

V	CA		
12/24 V	3200/1600 A	1	BBA1224-3200

Cables de arranque para baterías



BBJL

16	3	5	BBJL1630
25	3.5	1	BBJL2535
35	4.5	1	BBJL3545

Booster 12 V 1.200 CA



BBA12-1200

V	CA		
12	1200	1	BBA12-1200

Booster de condensadores híbrido 12V



BBH12-1200

V	CA		
12 V	1200 A	1	BBH12-1200

Cargador baterías eléctrico 12V-2A



BBCE612-2

760	2	BBCE612-2	



Cargador baterías eléctrico 12V-3 A



BBCE12-3

V **A** 2 BBCE12-3

12 V

3 A

2 BBCE12-3



Cargador mantenedor automático 15 amps para baterías de 12V con Función Showroom



BBCE12-15S

g 2 BBCE12-15S

1730

2 BBCE12-15S

Cargador baterías eléctrico 24V-10A



BBCE24-10

g 2 BBCE24-10

1460

2 BBCE24-10



Cargador baterías eléctrico 12V-6A



BBCE12-6

V **A** 2 BBCE12-6

12 V

6 A

2 BBCE12-6



Comprobador electrónico de baterías 6-12V



BBT60

mm 12 BBT60

228 x 285 x 80 mm

12 BBT60

Comprobador electrónico de baterías con impresora 6-12V



BBT80

mm 6 BBT80

64 x 130 x 251 mm

6 BBT80

Cargador baterías 12V



BBCE12-10

V **A** 1 BBCE12-10

12 V

10 A

1 BBCE12-10



Cargador de batería 100A



BBCE12-F100

V **A** 1 BBCE12-F100

12 V

4/20/70/100A A

1 BBCE12-F100

Cargador-arrancador de baterías 12/24V



BBC420-BBC620

V 1 BBC420
230 1 BBC620

230

1 BBC420

230

1 BBC620

Densímetro para baterías



BB10



50 x 50 x 285 mm



1 BB10

Comprobador de mandos de distancia



BELTKEY



35 x 63 x 160 mm



1 BELTKEY

Comprobador toma de remolque para sistemas 13 polos 12V



BELT1213



38 x 82 x 155 mm



1 BELT1213

Tester digital baterías 12 V



BBT20



90 x 160 x 345 mm



1 BBT20

Comprobador toma de remolque 7 polos 24 V (24S)
Aplicable en tomas 24S



BELT247S



35 x 63 x 155 mm



1 BELT247S

Multímetro



BMMTRMS1



155 x 60 x 225 mm



0,8 kg



1 BMMTRMS1

Comprobador toma remolque 7 polos 24V
Aplicable en tomas 24N



BELT247N



55 x 63 x 160 mm



1 BELT247N

Comprobador toma de remolque 15 polos 24V



BELT2415



38 x 83 x 155 mm



1 BELT2415

Comprobador toma de remolque 7 polos 12V



BELT127



35 x 63 x 160 mm



1 BELT127



Juego universal de útiles para terminales, 16 piezas



BELTRP16



58 x 215 x 265 mm

- 1 BELTRP16
- 1 BELTRP1601
- 1 BELTRP1602
- 1 BELTRP1603
- 1 BELTRP1604
- 1 BELTRP1605
- 1 BELTRP1606
- 1 BELTRP1607
- 1 BELTRP1608
- 1 BELTRP1609
- 1 BELTRP1610
- 1 BELTRP1611
- 1 BELTRP1612
- 1 BELTRP1613
- 1 BELTRP1614
- 1 BELTRP1615
- 1 BELTRP1616

Protector de circuito electrónico de vehículo 12V



BELMS12



37 x 125 x 600 mm

25 BELMS12

Protector de picos de 12 & 24V



BELP1224



35 x 63 x 160 mm

1 BELP1224

Protector de memorias 12V



BELS12



35 x 63 x 160 mm

1 BELS12

Protector de memorias toma OBDII



BELMS12OBDL



40 x 70 x 140 mm

8 BELMS12OBDL

Cargador de pared AC 12V para BBL12-400



BBL12-40003



130

1 BBL12-40003

Set de 3 adaptadores de enchufe para BBL12-400



BBL12-40004



45

1 BBL12-40004

Adaptador abrazaderas batería para BBL12-400



BBL12-40005



125

1 BBL12-40005

Adaptador puerto DC 12V para BBL12-400



BBL12-40006

31 x 100 x 160 mm	25	1	BBL12-40006

Conector de terminales (conexión rápida) para cargadores BBCE612-2, BBCE12-3 y BBCE12-6



BBCER1

100	1	BBCER1

Cargador de booster BBBC2A para BB24-1200



BBBC

55 x 85 x 165 mm 55 x 85 x 166 mm	1	BBBC2A BBBC4A

Pinzas para baterías (conexión rápida) para cargadores BBCE12-10 y BBCE24-10



BBCEC1

68	1	BBCEC1

Pinzas para baterías (conexión rápida) para cargadores BBCE612-2, BBCE12-3 y BBCE12-6



BBCEC2

68	1	BBCEC2

Cables para cargadores de arrancadores: Australia, Europa continental y RU



BBBCAB

50 x 125 x 50 mm 50 x 50 x 50 mm	1	BBBCAB-AUZ BBBCAB-UK

Estuche para BBL12-400



BBL12-40007

63 x 190 x 390 mm	255	1	BBL12-40007

Conector de terminales (conexión rápida) para cargadores BBCE12-10 y BBCE24-10



BBCER2

100	1	BBCER2

Fusible 16A



BBS702026

14 x 115 x 160 mm	15	15	BBS702026



Fusible para booster 500A



BBS702028

9 x 120 x 168 mm	500	1	BBS702028

Cargador de mechero 12V para booster BBA12-1200, BBA1224-1700



BBSNL4FX001

26 x 50 x 50 mm	12 V	1	BBSNL4FX001

PRENSAS Y ACCESORIOS

Presna pistón deslizante y c/pedal 100Tn



BH7100

100000 kg		1	BH7100A

Panel de seguridad para prensas



BH7

530	20	1	BH720SG
590	20	1	BH730SG
625	20	1	BH750SG

Juego de mandrinos para prensas 15T



BH715-13

7.09		1	BH715-13
7.09		1	BH720-22

Rejilla de seguridad para prensa de 100T



BH7100SG

150 x 593 x 625 mm	5.54 kg	1	BH7100SG

Presna Hidráulica con bomba doble velocidad

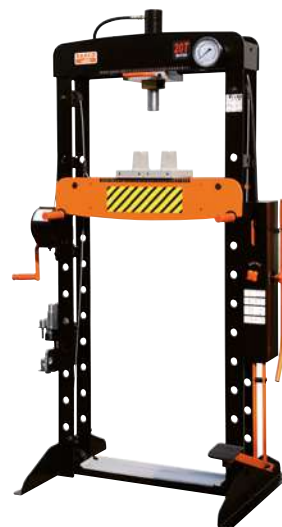

BH720/BH730/BH750

20.000		1	BH720
30.000		1	BH730
50.000		1	BH750

8 mandrinos presión incluidos
Pasadores de fijación de mesa autocentrantes

Presna de sobremesa 15T



BH715

15.000		1	BH715

EQUIPAMIENTO LIGERO

Plato magnético



1419-MD

150	1	1419-MD

Riel para BLBT100



BLBT100AC1

150 x 150 x 1025 mm	7.77 kg	1	BLBT100AC1

Cuñas para ruedas



BWC1

75 x 77 x 110 mm	25 BWC1

Cubre asientos de nylon de gran resistencia



5750

1390	1	5750

Fácilmente lavable

Dedo magnético flexible

ergo®



2535F

6 mm	260 mm	1	2535F0
12	400	1	2535F1
12	395	1	2535F2
17	392	1	2535F3

2535F2: Mango pequeño

Taburete con almacenaje regulable altura 435-555mm



BLE300

380 x 380 x 550 mm	136 kg	1	BLE300

Capacidad 136kg

Centrafaros laser dual



BLBT100

1650 x 500 x 565 mm	1	BLBT100

Plato magnético de 1500mm



BMD150

160	1	BMD150

Bandeja magnética con solapa PVC



BMR240

250	1	BMR240



Juego de 4 bolsas protectoras para ruedas y llantas



BWB1418S4/BWB1922S4



355 - 470 mm
470 - 560 mm

6 BWB1418S4
6 BWB1922S4

Camilla de perfil bajo 120mm



BLE301



120 x 590 x 1020 mm

136 kg

1 BLE301

Capacidad 135 Kg

Combi Camilla y Asiento



BLE302



135 x 490 x 1010 mm

136 kg

1 BLE302

Capacidad 135kg

Conjunto camilla y taburete



BLE304



460 x 1020 x 135 mm 116 / 100 kg

1 BLE304

Taburete amortiguado para taller de neumáticos



BLE305



430 x 410 x 430 mm

1 BLE305

HERRAMIENTAS PARA CARROCERÍA

Soporte universal con ventosas para lunas



BBS3BH1



955 mm

1 BBS3BH1

Soporte para piezas de carrocería



BBS3UH



950 x 800 x 1200 mm 20 kg

1 BBS3UH

2 ruedas fijas

2 giratorias 360° con sistema bloqueo

Ventosa para soporte universal



BBS3BH1-VP



60 x 95 x 95 mm

40 BBS3BH1-VP

Juego de extractores para brazos de limpiaparabrisas



BBS170P13

80 x 275 x 375 mm	1 BBS170P13 1 BBS170P131 1 BBS170P132 1 BBS170P133 1 BBS170P134 1 BBS170P135 1 BBS170P136 1 BBS170P137 1 BBS170P138 1 BBS170P139 50 BBS165SP4	

Juego Extractor Limpiaparabrisas Univ.



BBS165

117 x 25 x 78 mm	10 BBS165	

Ventosa para capacidad 75Kg.



BBS075

160	175	12	BBS075

Ventosas dobles y correa tensora



BBS150

120	400	1	BBS150

Útil cortajuntas parabrisas



BBS105

20 x 90 x 200 mm	1	BBS105

Incluye hoja L 25mm

Juego de tres cuchillas rectas en blíster



BBS107

1 x 18 x 125 mm	1	BBS107

Medidas: 19, 25, 38mm

Juego de tres cuchillas en 'L'



BBS108

20 x 19 x 88 mm	1	BBS108

Presentadas en blíster

Pareja de empuñaduras para alambre cortajuntas de parabrisas



BBS101

30 x 80 x 115 mm	1	BBS101



Cable para cortajuntas de parabrisas 50m



BBS150S

50	1	BBS150R
50	1	BBS150S
50	1	BBS150T

Cortajuntas BBS101

Tirador mango en T de alambre cortajuntas



BBS102

265 mm	1	BBS102

Tirador con mango de alambre cortajuntas



BBS103

25 x 25 x 345 mm	1	BBS103

Cuchillo de uretano para lunas / parabrisas



BBS10450

10 x 30 x 450 mm	0.240	1	BBS10450

Cuchilla trapezoidal de cutter estándar

Limpiador de canal de parabrisas



BBS106

25 x 25 x 332 mm	0.145	1	BBS106

Enderezador a inercia para carrocerías 12Kg



BBS12SH

800 mm	12 kg	1	BBS12SH

Longitud 800mm

Tas de cuña



BBSDW

25 x 64 x 112 mm	6	BBSDW

Martillo carrocerero cabeza redonda plana



BBSH2F

40	6	BBSH2F

Mango hickory

Cuchara para carrocerero



BBSS1

25 x 56 x 390 mm	1	BBSS1

Tas americano



BBSDA

30 x 63 x 83 mm	1	BBSDA

Martillo carrocerero cabeza plana lisa



BBSH1F

50x30	1	BBSH1F

Mango de hickory

Palanca para carrocerero



BBSS2

150 x 60 x 410 mm	8	BBSS2

Tas americano ligero



BBSDT

26 x 58 x 120 mm 6 BBSDT

Martillo carrocero cabeza cuadrillada



BBSH1M

50x30 1 BBSH1M

Mango de hickory

Palanca pesada para carrocero



BBSS2L

175 x 60 x 520 mm 2.3 1 BBSS2L

Tas Tacón



BBSDH

30 x 60 x 79 mm 1 BBSDH

Martillo carrocero cara redonda convexa
Cara redonda convexa (C)



BBSH2C

40 1 BBSH2C

Mango hickory genuino

Tas coma



BBSDC

40 x 58 x 128 mm 6 BBSDC

Martillo carrocero cara redonda convexa y otra
rectángulo angulado



BBSH2CA

40 12 BBSH2CA

Una cara redonda Convexa (C)
Otra cara rectángulo angulado

Tas de caucho para carrocero



BBSDHR

40 x 62 x 75 mm 1 BBSDHR

Núcleo de acero con recubrimiento de goma

Martillo carrocero cara redonda dentada y cuadrada
plana
Cara redonda dentada y cuadrada plana



BBSH3MF

30 27 1 BBSH3MF

Martillo para carrocero
Cabeza cuadrada plana, redonda abombada lista



BBSH3CF

40 37 6 BBSH3CF

F - Cuadrada plana
C - Abombada lista

Tas diábolo



BBSDD

55 x 55 x 55 mm 1 BBSDD

Martillo carrocero ligero cabeza cuadrillada, redonda
plana y lista



BBSH3FS

37 40 6 BBSH3FS

Cabeza cuadrada dentada (SM)
redonda plana y lista (F)



Martillo para carroceros ligero
Cabeza cuadrada lisa, redonda abombada lisa



BBSH3CF30

30	25	6	BBSH3CF30

Cuadrada (F)
Redonda abombada (C)

Martillo-pico para carroceros
Cabeza redonda abombada y lisa



BBSH2CP

40	6	BBSH2CP

Cabeza redonda (C) abombada y lisa

Mango repuesto para martillo BBSH



BBSHWH1

160	1	BBSHWH1

Equipo reparador de plásticos



BBS210

100 x 280 x 360 mm	1	BBS210
22 x 64 x 106 mm	1	BBS210U06
22 x 64 x 106 mm	1	BBS210U08
22 x 64 x 106 mm	1	BBS210UA06
22 x 64 x 106 mm	1	BBS210UA08
22 x 64 x 106 mm	1	BBS210V06
22 x 64 x 106 mm	1	BBS210V08
22 x 64 x 106 mm	1	BBS210W06
22 x 64 x 106 mm	1	BBS210W08

Abrazadera para carroceros



BH8BC1

45 x 135 x 230 mm	1	BH8BC1

Abrazadera para carroceros



BH8BC2

51 x 150 x 220 mm	1	BH8BC2

Juego de útiles para interiores universal, 12pzs



BBS20P12

35 x 355 x 585 mm	1	BBS20P12

Abrazadera para carroceros



BH8BC3

90 x 65 x 240 mm	10	BH8BC3

Leva para clip de guarnecidos



2485

240	1	2485

Abrazadera para carroceros



BH8BC4



80 x 120 x 175 mm



6 BH8BC4

Pinza para tapicería de puertas



BBS200



240



10 BBS200

Abrazadera para carroceros



BH8BC5



45 x 155 x 230 mm



6 BH8BC5

Juego herramientas universal para extracción de Air bags, 12 PZs (VW, Audi, Mercedes, BMW, Opel, Renault...)



BBS100



55 x 160 x 275 mm



- 1 BBS100
- 1 BBS10001
- 1 BBS10002
- 1 BBS10003
- 1 BBS10004
- 1 BBS10005
- 1 BBS100057
- 1 BBS10006
- 1 BBS10007
- 1 BBS10008
- 1 BBS10009
- 1 BBS10010

Soldador de gas profesional



BGIS125



25-125 W



46 x 88 x 295 mm



20 BGIS125

Juego de 4 espátulas



2220



125



1 22209004B

Remachadora para tuercas M3-M6



1468-M6



20 x 110 x 265 mm



1 1468-M6

Juego: 1468-M6

Cabeza de remachadora para tuercas M3-M6.



1468-6M



- 15 x 15 x 50 mm
- 13 x 13 x 50 mm
- 25 x 25 x 55 mm
- 20 x 20 x 55 mm



- 1 1468-6M3
- 1 1468-6M4
- 1 1468-6M5
- 1 1468-6M6

Remachadora para tuercas M4-M10
Juego 1468-M10



1468-M10



50 x 210 x 575 mm



1 1468-M10



Juego de manguitos para 1468-M10



1468-10-1

70	1	1468-10-1

Cabeza de remachadora para tuercas M4-M10



1468-10M

17 x 17 x 90 mm	1 1468-10M4
17 x 17 x 90 mm	1 1468-10M5
20 x 20 x 90 mm	1 1468-10M6
20 x 20 x 85 mm	1 1468-10M8
20 x 20 x 85 mm	1 1468-10M10

Juego portátil para carroceros



BH8PR

220 x 480 x 1030 mm	31	1 BH8PR10000
168 x 345 x 575 mm	18.65	1 BH8PR4000

EQUIPOS DE ELEVACIÓN

Gato de botella con base roscada



BH4S

2000	180 x 83 x 93 mm	6 BH4S2
4000	190 x 91 x 100 mm	6 BH4S4
6000	215 x 96 x 114 mm	4 BH4S6
8000	230 x 103 x 120 mm	4 BH4S8
12000	235 x 117 x 135 mm	3 BH4S12
20000	240 x 145 x 153 mm	1 BH4S20

Gatos de botella con base soldada



BH4

2000	180 x 103 x 103 mm	1 BH42
5000	210 x 110 x 110 mm	1 BH45
10000	220 x 124 x 128 mm	1 BH410
15000	235 x 140 x 140 mm	1 BH415
20000	240 x 165 x 160 mm	1 BH420
30000	245 x 185 x 175 mm	2 BH430

Gato de foso doble pistón 500Kg



BH5SP500QA

2041 x 660 x 660 mm	1 BH5SP500QA

Gato de foso doble pistón 1000 Kg



BH5DP1000QA

1000	1954 x 759 x 759 mm	1 BH5DP1000QA

Cabeza giroscópica para gatos de foso



BH5US1000

250 x 340 x 420 mm	260-510	1 BH5US1000

Gato carretilla multifunción 1Tn



BH1M1000

1000	1280 x 478 x 700 mm	1 BH1M1000

Gato con doble pistón 3Tn



BH1EU3000



3000 1400 x 340 x 617 mm 1 BH1EU3000

Gato Aluminio 1,5Tn



BH1A1500



1500 567 x 145 x 255 mm 1 BH1A1500

Gato con aproximación rápida 3Tn



BH13000QA



3000 220 x 395 x 900 mm 1 BH13000QA

Gato extra bajo 1,5 Tn
Elevación extra larga



BH11500



1500 1270 x 364 x 945 mm 1 BH11500

Gato de aluminio 2.5 Tn



BH1A2500



2500 200 x 370 x 800 mm 1 BH1A2500

Gato largo alta elevación 3Tn



BH13000L



3000 1310 x 530 x 1370 mm 1 BH13000L

Gato extra bajo 2 Tn
Gato 2T



BH12000



2000 1270 x 364 x 780 mm 1 BH12000

Gato compacto 3 Tn



BH13000



3000 1280 x 364 x 825 mm 1 BH13000

Travesía para gato de carretilla 1Tn



BH1CB1000



1000 145 x 125 x 710 mm 1 BH1CB1000

Compatible con BH1M1000,
BH11500, BH1200 y BH13000



Gato de carretilla extralargo 5Tn
Gato 5T



BH15000A

5000	1260 x 375 x 2327 mm	1 BH15000A

Gato extra largo 10Tn
Gato 10T



BH110000A

10000	1260 x 408 x 2626 mm	1 BH110000A

Gato tijera 4-5Tn



BH1S45

4000	1194 x 212 x 680 mm	1 BH1S45

Extensiones de 120mm para gatos BH15000A y
BH110000A



BH15000A-EXT/BH110000A-EXT

108 mm 151 mm		1 BH15000A-EXT 1 BH110000A-EXT

Pedal goma repuesto



BH1EU3000-03

BH1A1500 BH1A2500 BH1EU3000 BH15000A BH110000A		1 BH1A1500-01 1 BH1A2500-01 1 BH1EU3000-03 1 BH15000A-04 1 BH110000A-04

Ruedas delanteras de repuesto



BH1

BH1A2500 BH13000 BH1EU3000 BH1M1000, BH11500, BH12000 BH1S45 BH15000A BH110000A		1 BH1A2500-03 1 BH13000-02 1 BH1EU3000-01 1 BH11500-02 1 BH1S45-03 1 BH15000A-02 1 BH110000A-02

Ruedas traseras de repuesto



BH1

BH1A1500 BH1A2500 BH1M1000, BH11500, BH12000, BH13000 BH1EU3000 BH13000L BH1S45-01 BH15000A, BH110000A		1 BH1A1500-04 1 BH1A2500-04 1 BH11500-01 1 BH1EU3000-08 1 BH13000L-01 1 BH1S45-01 1 BH15000A-01

Gato oleoneumático 30Tn



BH230

360	627	1 BH230

Gato oleoneumático compacto 30/15 Tn



BH23015C

30000	1350 x 290 x 430 mm	1 BH23015C

Gato oleoneumático 30 / 15 T



BH23015

30000	1250 x 282 x 810 mm	1	BH23015

Gato oleoneumático 60/40/20 t
Gato 60/40/20T



BH2604020

60000	1250 x 295 x 875 mm	1	BH2604020

Gato neumático 2 niveles



BH9BJ22SSH

2000	345 x 265 x 265 mm	1	BH9BJ22SSH

Gato oleoneumático 40/20/10 Tn
Gato 40/20/10T



BH2402010

40000	1225 x 302 x 825 mm	1	BH2402010

Plato universal para gatos oleoneumáticos



BH2AC60

78 x 70 x 110 mm	0.97	1	BH2AC60V110
80 x 140 x 140 mm	2.96	1	BH2AC60-140

Gato neumático 3 niveles



BH9BJ23

2000	1000 x 250 x 250 mm	1	BH9BJ23SLH

Incluida extensión de 60mm, BH9BJ23SLH tiene mango L, BH9BJ23SSH tiene mango S

Set adaptadores



BH2AC

67 mm	45-75 mm	1	BH2AC1
75 mm	45-75 mm	1	BH2AC2

Gato neumático de 2 niveles



BH9BJ22

2000	1000 x 265 x 265 mm	1	BH9BJ22SLH

Incluida extensión de 60mm. BH9BJ22SLH tiene mango L, BH9BJ22SSH tiene mango S

Gato Neumático 3 Niveles



BH9BJ23SSH

2000	490 x 250 x 250 mm	1	BH9BJ23SSH



Extensión de acero para gatos neumáticos



BH9BJ260

970	1180	1	BH9BJ260
		1	BH9BJ280

Carretilla transportadora



BH1CD680

16.22 kg	610 x 240 x 220 mm	1	BH1CD680

Soporte para carretillas transportadoras



BH1CD680ST

715 x 130 x 155 mm	135	1	BH1CD680ST

Barra soporte para motores
Capacidad 500 Kg



BH8AC1-500

680 x 235 x 1700 mm	18,2	1	BH8AC1-500

Gato hidráulico sacarruedas para camión
Capacidad: 600kg



BH8AC3-600

1030 x 1050 x 1020 mm	93,5 kg	1	BH8AC3-600

Gato sacarruedas V.I 1.500kg



BH8AC3-1500

1730 x 1235 x 1425 mm	174 kg	1	BH8AC3-1500

Pareja de caballetes



BH33000/BH36000

3000	1	BH33000
6000	1	BH36000

Caballete para vehículo industrial



BH3HD

8000	2	BH3HD8000

Perno de seguridad (BH3HD1200)
equipado con un sistema de tirador

Caballete para vehículos 12T 1P



BH3HD12000

12000	1	BH3HD12000

Caballote para vehiculos 16T 1P



BH3HD16000

16000	1	BH3HD16000

Par de caballotes ligeros aluminio 2,5Tn



BH3AL2500

2500	1	BH3AL2500

Grúa plegable 2Tn



BH6FC2000

2640 x 1220 x 1845 mm	170	1	BH6FC2000

Altura entrada mínima: 130mm
Altura máx de gancho: 2.640mm

Caballote 20T para tareas pesadas



BH3HD20000A

20000	1	BH3HD20000A

Caballote de base cuadrada



BH3SQ

7000	2	BH3SQ7000
15000	2	BH3SQ15000

Grúa plegable 600Kg



BH6PC600

2315 x 1040 x 1480 mm	96	1	BH6PC600

Pareja de caballotes automáticos



BH3A

3000	340 x 188 x 230 mm	1	BH3A3000
5000	405 x 263 x 294 mm	1	BH3A5000
10000	526 x 327 x 382 mm	1	BH3A10000

Grúa plegable 1Tn
Altura máxima 2 m



BH6FC1000

2175 x 1030 x 1480 mm	85	1	BH6FC1000



Bolsa para tornillos y vasos de ruedas







BWBB

			
0.023 kg	180 x 1 x 300 mm	200	BWBB

Bote de aceite de repuesto hidráulico ISO VG15 de 250 ml



BHVG15-250

			
160 x 60 x 60 mm	220	12	BHVG15-250



Iluminación



LINTERNAS MANUALES

Lámpara-linterna con USB



BLTS7P



45



58 BLTS7P

IP 20

Lámpara-linterna compacta y ligera con Aluminio



BLTFC1



180



20 BLTFC1

IP 20 - Ángulo difusión 120°

Batería Li-on

Lámpara de inducción Heavy Duty



BLTS6I



200



15 BLTS6I

Set de iluminación Lámpara-linterna Aluminio



BLTI3P



100-140



18 BLTI3P

Batería Li-on 2000 mAh

Lámpara de taller 68 SMD LED



BLS68



350



21 BLS68

IP 65

Lámpara de taller 128 LED SMD



BLS128



575



20 BLS128

IP65

Lámpara-linterna ultra ligera con mini USB



BLTS10



400



20 BLTS10

LINTERNAS UV

Lámpara-linterna flexible con luz UV con cable, imán y ganchos



BLTFS6U



250



9 BLTFS6U

Lámpara 4SMD

Linterna 1SMD

LINTERNAS PARA LA CABEZA

Lámpara de cabeza 260 lumens y 2 modos



BFRL11



260 lm



1 BFRL11

Lámpara para capó 128 LED SMD a batería



BLX128

575	10	BLX128

Batería de Li-ion
Lámpara sólo BLS128

Enrollador de cable 400V



BLCR400E

400	2800/5000	1	BLCR400E

15m
IP24

ENROLLADORES DE CABLE

Enrollador de cable para trabajos a 230V



BLCR230

230	800/2000	1	BLCR230FR
230	800/2000	1	BLCR230SC

Adaptador de control de velocidad BLCRSC1 opcional

Adaptador de control de velocidad para el enrollador cable



BLCRSC

BLCR			
230PL, FR, SC	76 x 91 x 117 mm	1	BLCRSC1
24VCL,VLL	76 x 91 x 117 mm	1	BLCRSC2

Lámpara de taller con carrete enrollador 24V con transformador



BLCR24V

230/24	60	1	BLCR24VCL
230/24	60	1	BLCR24VLL

Adaptador de control de velocidad opcional BLCRSC2





BAHCO



Herramientas de inspección



ENDOSCOPIOS

Videoscopio



BE210

mm	kg		
105 x 325 x 400 mm	2.67	1	BE210
5 x 50 x 56 mm	0.04	1	ZHVIDEOBAT
40 x 44 x 75 mm	0.17	1	ZHVIDEOCHA

Endoscopio



BE200

mm	kg		
100 x 325 x 390 mm	2.19	5	BE200

Cables lente
Adecuado para BE200 y BE210



BE200C

mm	L		
25	10	1	BE200CAB250SH10
25	25	1	BE200CAB250SH25
25	3	1	BE200CAB250SH3

mm	L		
14	1	1	BE200CAB40F1
5.5	1	1	BE200CAB55F1
14	3	1	BE200CAB55F3
14	1	1	BE200CAB58SR1
14	3	1	BE200CAB58SR3
14	1	1	BE200CAB80SR1
14	3	1	BE200CAB80SR3

Espejos y puntas magnéticas



BE200M

mm	mm		
0	4	1	BE200MAG4
0	5.5, 5.8	1	BE200MAG55
	8	1	BE200MAG80
35	5.5, 5.8	1	BE200MIR5535
45	5.5, 5.8	1	BE200MIR5545
55	5.5, 5.8	1	BE200MIR5555
35	8	1	BE200MIR8035
45	8	1	BE200MIR8045
55	8	1	BE200MIR8055
35	4	1	BE200MIR4035
45	4	1	BE200MIR4045
55	4	1	BE200MIR4055

ESTETOSCOPIOS

Estetoscopio electrónico de mecánico



BE220

mm	kg		
130 x 370 x 340 mm	2.94	1	BE220

Estetoscopio, sonda de acero



5050

L			
1050	1	5050	

ESPEJOS

Espejo flexible para taller



2510

L	mm		
505	50x75 mm	1	2510

Espejo articulado



5515GV

L	mm		
215	30	1	5515GV

Espejo telescópico con cabeza giratoria



5515T-52



255-450 52 25 5515T-52

Espejo de reparación con mango metálico



5515M



210 30 1 5515M

Espejo luminoso flexible y orientable



BL1FM



610 30x55 mm 1 BL1FM

Espejo auxiliar



5515L



160 21 1 5515L

Espejo de reparación en plástico



5515B



220 31.5 25 5515B

Espejo telescópico de bolsillo



5515T



180-690 30 25 5515T





BAHCO

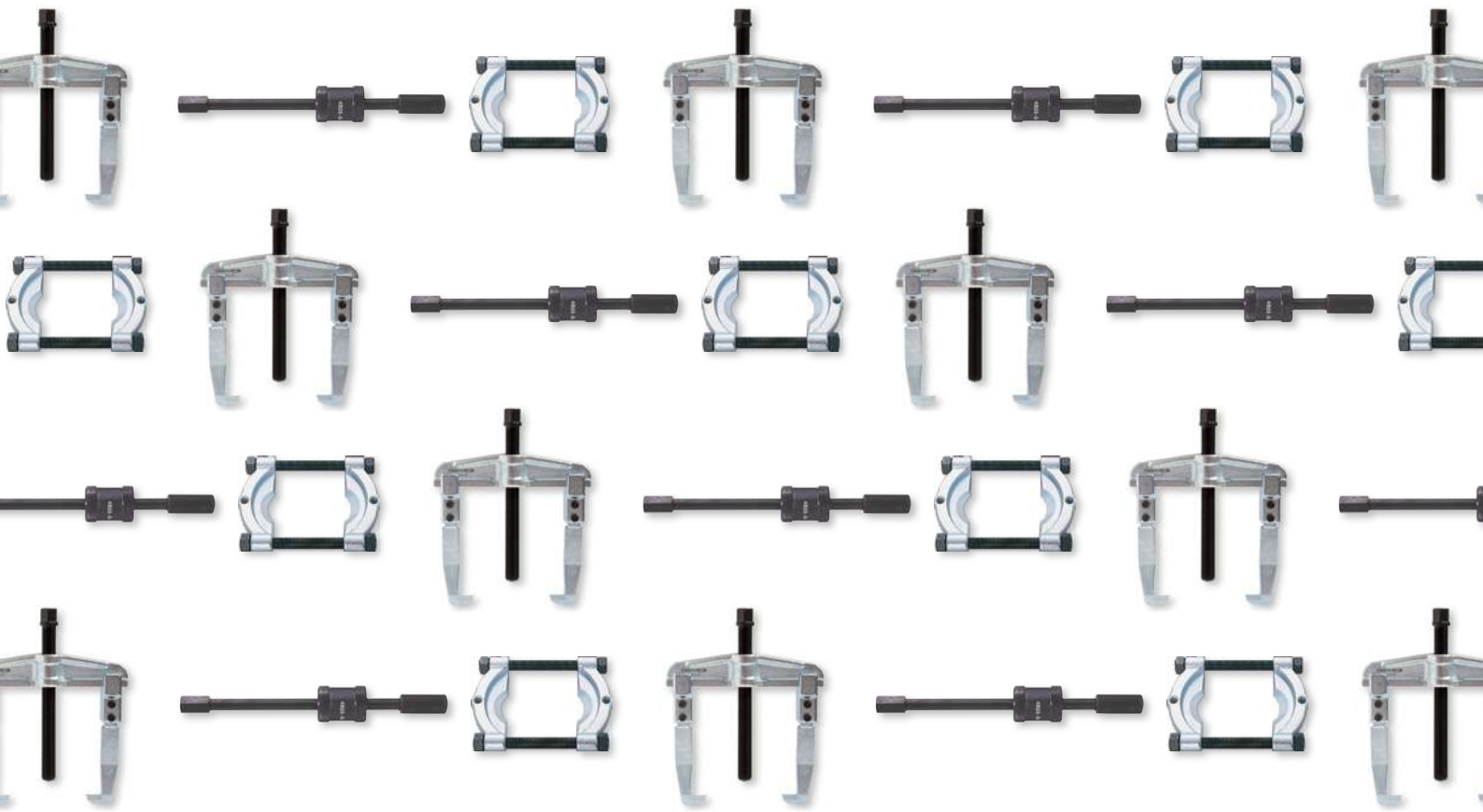

Extractores



MECÁNICO

Extractor universal de dos garras



4532

25-80 mm	100 mm	1			4532-A
25-80 mm	200 mm	1			4532-AL
25-130 mm	100 mm	1			4532-B
25-130 mm	200 mm	1			4532-BL
50-160 mm	150 mm	1			4532-C
50-160 mm	300 mm	1			4532-CL
60-200 mm	150 mm	1			4532-D
80-250 mm	200 mm	1			4532-E
80-350 mm	200 mm	1			4532-F
110-520 mm	200 mm	1			4532-G
110-520 mm	200 mm	1			4532-G-SO
170-640 mm	225 mm	1			4532-H
135 mm			1		4532-A/B
174 mm			1		4532-B/B
220 mm			1		4532-C/B
260 mm			1		4532-D/B
330 mm			1		4532-E/B
415 mm			1		4532-F/B
580 mm			1		4532-G/B
705 mm			1		4532-H/B
	100 mm		1		4532K1
	150 mm		1		4532K2
	200 mm		1		4532K3
	225 mm		1		4532K4
	200 mm		1		4532LK1
	300 mm		1		4532LK2
	300 mm		1		4532LK3
	400 mm		1		4532LK4
	500 mm		1		4532LK5
			1		4532-OAB/S
			1		4532-CD/S
			1		4532-EFG/S
			1		4532-H/S

Cuerpo: 4532/B; Par de garras: 4532K;
Par de garras largas: 4532LK; Husillo: 4532/S

Extractor de garras estrechas



4532-0

20-90 mm	100 mm	1			4532-0
140 mm		1			4532-O/B
	100 mm	1			4532KO

Cuerpo: 4532-0/B; Par de garras: 4532K0; Husillo: 4532-OAB/S

Extractor 2 brazos universal



3115

80-250 mm	300 mm	1			3115

Expositor de extractores de dos garras



4532ST/5

16700			1		4532ST/5

4532-A, 4532-B, 4532-C, 4532-D, 4532-E

Extractor de tres garras



4533

150-700 mm	185 mm	1			4533HP
150-700 mm	200 mm	1			4533M
	185 mm	1			4533HPK
	200 mm	1			4533MK
		1			4533HP/S
		1			4533M/S

4533HP - Sistema hidráulico; 4533M - Mecánico

4533/K: Juego 3 garras; 4533/S: Husillo de repuesto

Gato hidráulico



4529

Tn max				
8	60	1		4529-8
15	70	1		4529-15

Extractor: Hidráulico de 3 garras - Industria Pesada Y brazos de repuesto



4528

50-350 mm	135 mm	1			4528-1
350 mm			1		4528-1/B
	135 mm		1		4528K1
	235 mm		1		4528K2
	285 mm		1		4528K3
	335 mm		1		4528K4
	385 mm		1		4528K5





Juego 3 garras: 4528K; Cuerpo: 4528/B;
Husillo sist. hidráulico 4533HP/S

Extractor de 2 y 3 garras



4544

10-100 mm	80 mm	1			4544-1
10-120 mm	120 mm	1			4544-2
20-160 mm	160 mm	1			4544-3
20-200 mm	200 mm	1			4544-4
10-100 mm	80 mm	1			4544-10
10-120 mm	120 mm	1			4544-20
20-160 mm	160 mm	1			4544-30
100 mm		1			4544-1/B
120 mm		1			4544-2/B
160 mm		1			4544-3/B
200 mm		1			4544-4/B
100 mm		1			4544-10/B
120 mm		1			4544-20/B
160 mm		1			4544-30/B
	80 mm	1			4544K110
	120 mm	1			4544K220





			
160 mm		1	4544K330
200 mm		1	4544K440
		1	4544-110/S
		1	4544-220/S
		1	4519-1/S
		1	4544-440/S

2 garras: 4544-1/4; 3garras:4544-10/30;
Cuerpo:4544/B Garra:4544K; Husillo:4544/S

Extractor de 2 o 3 garras



4543





			
10-60 mm	40 mm	1	4543-1
10-70 mm	74 mm	1	4543-2
10-90 mm	84 mm	1	4543-3
10-60 mm	40 mm	1	4543-10
10-70 mm	74 mm	1	4543-20
10-90 mm	84 mm	1	4543-30
70 mm		1	4543-12/B
90 mm		1	4543-3/B
70 mm		1	4543-1020/B
100 mm		1	4543-30/B
	40 mm	1	4543K110
	74 mm	1	4543K220
	84 mm	1	4543K330
		1	4543-1/S
		1	4543-2/S
		1	4543-3/S

2 garras: 4543-1/3; 3garras 4543-10/30;
Cuerpo:4543/B; Garra:4543K; Husillo:4543/S

Extractor de dos garras



4541





			
20-150 mm	85 mm	1	4541-A
40-220 mm	130 mm	1	4541-B
150 mm		1	4541-A/B
220 mm		1	4541-B/B
	85 mm	1	4541KA
	130 mm	1	4541KB

Cuerpo: 4541/B; Garra: 4541K; Husillo A:4532-03B/S y Husillo B:4519-1/S
4532-4519/S: Husillo de repuesto

Extractor de 3 garras



4542





			
20-150 mm	85 mm	1	4542-A
40-220 mm	130 mm	1	4542-B
150 mm		1	4542-A/B
220 mm		1	4542-B/B

Cuerpo: 4542/B; Garra: 4541K; Husillo A:4532-03B/S y Husillo B:4519-1/S
4532-4519/S: Husillo de repuesto

Extractor: 2 garras - Industria Pesada



4537

			
20-170 mm	130 mm	1	4537-1
20-230 mm	200 mm	1	4537-2
50-300 mm	250 mm	1	4537-3
50-350 mm	350 mm	1	4537-4
170 mm		1	4537-1/B
230 mm		1	4537-2/B
350 mm		1	4537-34/B
	130 mm	1	4537K1
	200 mm	1	4537K2
	250 mm	1	4537K3
	350 mm	1	4537K4





Cuerpo: 4537/B; Garra: 4537K; Husillo 1: 4532-03B/S, husillo 2: 4519-1/S,
husillo 3 y 4: 4519-2/S
4532-4519/S: Husillo de repuesto

Extractor de 3 garras - Industria Pesada



4528M

			
		1	4528M1/P
		1	4528M2/P





			
		1	4528M3/P
20-170 mm	130 mm	1	4528M1
20-230 mm	200 mm	1	4528M2
50-300 mm	250 mm	1	4528M3
50-350 mm	350 mm	1	4528M4
50-400 mm	400 mm	1	4528M5
170 mm		1	4528M1/B
230 mm		1	4528M2/B
400 mm		1	4528M345/B
	400 mm	1	4528MK5

Cuerpo:4528M/B; Garra:4537K-4528MK; Husillo 1: 4532-03B/S, husillo 2: 4519-1/S, husillo 3, 4 y 5: 4519-2/S
Husillo 4532/S-4519/S

Extractor con abrazadera



4519





			
20-110 mm	80-170 mm	1	4519-1
40-150 mm	90-270 mm	1	4519-2
40-150 mm	90-330 mm	1	4519-3
110 mm		1	4519-1/B
150 mm		1	4519-23/B
	170 mm	1	4519K1
	270 mm	1	4519K2
	330 mm	1	4519K3
		1	4519-2/S

Cuerpo: 4519/B; Garra: 4519K; Husillo: 4519/S

Extractor tipo tijera



4614

			
6-100 mm	70-85 mm	1	4614-1
10-140 mm	85-120 mm	1	4614-2
100 mm		1	4614-1/B
140 mm		1	4614-2/B
	80 mm	1	4614K1
	120 mm	1	4614K2

Cuerpo:4614/B; Par de garras:4614K;
Husillo 4543-4532/S



Extractor de garras múltiples, 5 piezas



4540

Husillo		Garra	
30-170 mm	65-140 mm	1	4540-17
	65 mm	1	4540-17/K4
	100 mm	1	4540-17/K3
	140 mm	1	4540-17/K2
	140 mm	1	4540-17/K1
		1	4540-17/S
75-250 mm	77-180 mm	1	4540-25
	77 mm	1	4540-25/K4
	122 mm	1	4540-25/K3
	180 mm	1	4540-25/K2
	180 mm	1	4540-25/K1
		1	4540-25/S

Husillo: 4540/S; Garra: 4540/K; Curvada: 4540-K3&K4;
Cónca: 4540-K2; Recta: 4540-K1

Separador de guillotina

Husillo: 4551-xx/S



4551

Husillo		Garra	
4552-1		1	4551-A
4552-1		1	4551-B
4552-2		1	4551-C
4552-3		1	4551-D
		1	4551-A/S
		1	4551-B/S
		1	4551-C/S
		1	4551-D/S

4551A: 10-60mm; 4551B: 15-75mm
4551C: 35-115mm; 4551D: 40-150mm

Juego de extractores y separadores



4574



105 x 300 x 360 mm



1 4574

4532-A, 4532-C, 4532LK1, 4532LK2

4551-C

4529-15

Extractor de rodamientos sin garras



4581N-4583N



4581NA, 4581NB	1	4581N-1
4581NB2, 4581NC, 4582NA	1	4582N-1
4581NC, 4582NA, 4582NB	1	4582N-2
4582NA, 4583NA, 4583NB	1	4583N-1
4582NA, 4582NB, 4583NB	1	4583N-2

Garras de repuesto - juego de 4 pzs



4581NA-4583NB



145	4581N-1	1	4581NA
120	4581N-1	1	4581NB
130	4582N-1	1	4581NB2
130	4582N-1, 4582N-2	1	4581NC

Husillo		Garra	
150	4582N-1, 4583N-2	1	4582NA
150	4582N-2, 4583N-2	1	4582NB
190	4583N-1	1	4583NA
235	4583N-1, 4583N-2	1	4583NB

Juego extractores de rodamientos



4578



75 x 235 x 285 mm



1 4578

4 jgos garras 4 pzs cada: 4581NA y 4581NB para
4581N-1; 4581NB2 y 4581NC para 4582N1 NB2-NC

Extractor interior para rodamientos



4521N



5-7		1	4521N-00
7-9		1	4521N-0
9-12		1	4521N-A
10-13		1	4521N-B
13-17		1	4521N-C
14-19		1	4521N-D
16-21		1	4521N-E
18-23		1	4521N-F
20-25		1	4521N-G
25-30		1	4521N-H
30-37		1	4521N-I
35-42		1	4521N-K
38-45		1	4521N-L
43-50		1	4521N-M
40-75		1	4521N-S
70-115		1	4521N-T

Puente de apoyo
Para usar junto con 4521



4522

L		mm	
35-75	1	4522-1	
60-130	1	4522-2	
35-75	1	4522-1/B	
60-130	1	4522-2/B	
	1	4522K1	
	1	4522K2	
	1	4522-1/S	
	1	4522-2/S	

Cuerpo:4522/B; Garra:4522K; Husillo:4522/S
4522/S: Husillo de repuesto

Barra de impacto para cabezas 400 gr



4523G

L		mm	
Ø10x170	1	4523G	

Para 4521N-00/E

Barra de impacto para cabezas 1.3 kg



4524G

L		mm	
Ø16 x 250	1	4524G	

Para 4521N-F & 4521N-M

Juego de extractores de rodamientos de bolas



4580N/7

mm		mm	
66 x 192 x 287	1	4580N/7	

4581N-1, 4582N-1, 4582N-2, 4583N-1,
4583N-2, 4581NA to 4583NB

Juego de extractores de rodamientos
Bolas interiores



4521N/7

mm		g	
95 x 360 x 310	6800	1	4521N/7

4521N-D, 4521N-H, 4521N-I, 4521N-L, 4521N-S,
4521N-G
4522-1, 4522-2

Extractor universal de rótulas



4545-N

mm		mm	
Max 50 mm	18-22	1	4545-N1
Max 90 mm	27-36	1	4545-N11
Max 50 mm	26	1	4545-N2
60-80 mm	26	1	4545-N21
		1	4545-N1/S
		1	4545-N2/S

Husillo: 4545/S

Juego extractores mini



4579

mm		mm	
65 x 210 x 275	1	4579	

Extractores 2 garras: 4543-2, 4543-3; Cuerpos:
4543-1020/B, 4543-30/B; Garras: 4543K220, 4543K330

Juego de extractores para mantenimiento de vehículos



4577

mm		mm	
70 x 340 x 425	1	4577	

4545-N2
4532-B
4614-1
4521N-D, 4521N-B, 4521N-H, 4521N-I, 4521N-G,
4521N-L
4522-1

Juego extractores interiores y exteriores



4590SHS5





mm		mm	
79 x 230 x 500	4	4590SHS5	



Extractor de cubos de ruedas





4518

   			
225 mm	140 mm	1	4518-3
225 mm	140 mm	1	4518-4
225 mm	140 mm	1	4518-5

Extractor de rótulas



4545

  		
18 mm	1	4545-1
25 mm	1	4545-2
29 mm	1	4545-3
40 mm	1	4545-4
45 mm	1	4545-5

Tronzatuercas hidráulico
Código de hoja de repuesto: 4610-1/B



4610

  		
M4-M14	1	4610-1

Tronzatuercas mecánico



4611

  		
M16	1	4611-2
M24	1	4611-3

4611-2 Hoja: 4611-2/B; Husillo: 4611-2/S

Hojas de repuesto para tronzatuercas mecánico



4611/B

  		
60	1	4611-2/B
60	1	4611-3/B

Husillos de repuesto para tronzatuercas mecánico





4611/S

  		
90	1	4611-2/S
130	1	4611-3/S

Extractor de espárragos



4553

  		
5-20	1	4553

Grosor de cabeza: 10mm

Extractor de espárragos





4591-4593

  		
5-15	1	4591
10-19	1	4592
18-28	1	4593

Extractor de espárrago
Para tornillos y pernos rotos







1420-1424

  		
M 3-6	1	1420-1.4
M 6-8	1	1421-2.1
M 8-11	1	1422-3.1
M11-14	1	1423-4.8
M14-18	1	1424-6.2

Juego de 5 extractores de espárragos



1435/5

   			
15 x 50 x 90 mm	110	1	1435/5

1420-1.4, 1421-2.1, 1422-3.1, 1423-4.8, 1424-6.2

Juego de 8 extractores de espárragos
Para tornillos de M4 a M45



1435/8

29 x 110 x 118 mm	700	1	1435/8

1420-1.4, 1421-2.1, 1422-3.1, 1423-4.8, 1424-6.2

Extractores para tornillos rotos



1419-M5/1419-M16

M5-M10	1	1419-M5
M8-M14	1	1419-M8
M12-M20	1	1419-M12
M16-M24	1	1419-M16

Juego de 4 extractores de espárragos para tornillos rotos
4 piezas



1419/4

M5-M24	430	1	1419/4

M5-M10; M8-M14; M12-M20; M16-M24

Juego 15 puntas extractoras de espárragos



BWMSP15

43 x 90 x 200 mm	0,54	1	BWMSP15

Puntas extractoras de espárragos



BWMSP15

3	1/2	1	BWMSP1501
4	1/2	1	BWMSP1502
5	1/2	1	BWMSP1503
5.5	1/2	1	BWMSP1504
6	1/2	1	BWMSP1505
8	1/2	1	BWMSP1506
10	1/2	1	BWMSP1507
1/8	1/2	1	BWMSP1508
3/16	1/2	1	BWMSP1509
1/4	1/2	1	BWMSP1510
3/8	1/2	1	BWMSP1511
11	5/8	1	BWMSP1512
12	5/8	1	BWMSP1513
14	5/8	1	BWMSP1514
1/2	5/8	1	BWMSP1515

Juego de extractores de espárrago
Para tornillos y pernos rotos



1418S

25 x 127 x 162 mm	M6-M16	1	1418S

1411-3.2, 1412-4.8, 1413-6.4, 1414-8, 1415-8.7

1418A, 1418B, 1418C, 1418D, 1418E, 1418F, 1418G, 1418H, 1418I, 1418K

Extractores de espárrago



1411-1415

M6	1	1411-3.2
M8	1	1412-4.8
M10	1	1413-6.4
M12	1	1414-8
M14-M16	1	1415-8.7

Casquillos guía para extractores de espárragos



1418A-K

6 mm	1	1418A
8 mm	1	1418B
8 mm	1	1418C
8 mm	1	1418D
10 mm	1	1418E
11 mm	1	1418F
12 mm	1	1418G
12 mm	1	1418H
13 mm	1	1418I
14 mm	1	1418K

Juego de extracción y colocación de espárragos



1411AUP8

228 x 198 x 80 mm	0.55	1	1411AUP8



Extractor de esparragos



1411AUP81-1411AUP84

M6	1	1411AUP81
M8	1	1411AUP82
M10	1	1411AUP83
M10	1	1411AUP84

Juego de herramientas
Para el mecanizado de roscas



1460Z/2

53 x 407 x 220 mm	1/4-3/4	1	1460Z/2

Lima doble para roscas interiores y exteriores, pulgadas



1450D-WW

230	1	1450D-WW

HERRAMIENTAS PARA ROSCAS

Juego de herramientas
Para el mecanizado de roscas



1460M/1

53 x 407 x 220 mm	M5-M12	1	1460M/1

Giramachos de carraca reversible



600

3-10	1	600.003.010
5-12	1	600.005.012

Juego de limas dobles



1450D/2

40 x 70 x 270 mm	M5-M27	1	1450D/2

Juego de herramientas
Para el mecanizado de roscas



1460M/2

53 x 407 x 220 mm	M5-M20	1	1460M/2

Lima doble para roscas interiores y exteriores, mm
Métricas



1450D-ISO

230	1	1450D-ISO

Paso Rosca 5-27

1450D-ISO	
1450D-WW	

PALANCAS

Extractor de clavos



2632

170	1	2632

Palanca



3683



400



1 3683

Palanca especial



3680



400



1 3680

Palanca mutiusos



BPBL



930
925
610
628



5 BPBL00900
5 BPBL30900
5 BPBL70600
5 BPBL90600

Palanca polivalente



3681



304
406
503



1 3681-11
1 3681-16
1 3681-20

Elevador con mango plástico



2484-20/2484-60



200
300
450
600



1 2484-20
1 2484-30
1 2484-45
1 2484-60

Set de palancas multiusos largas



BPBLS4



78 x 255 x 1000 mm



9050



2 BPBLS4

BPBL00900, BPBL30900, BPBL70600,
BPBL90600

Palanca



3684



406
457
609
760



50 3684-16
1 3684-18
1 3684-24
1 3684-30

Juego de 4 palancas
200, 300, 450 y 600mm



2484/S4



35 x 115 x 640 mm



10 2484/S4

2484-20, 2484-30, 2484-45, 2484-60





BAHCO



Almacenamiento de herramientas y composiciones



CARROS DE HERRAMIENTAS

Carro Premium E77

Carro robusto de 9 cajones con amortiguadores de protección individuales



BLACK
GREY

1477K9



976 x 510 x 820 mm	1	1477K9
976 x 510 x 820 mm	1	1477K9BLACK
976 x 510 x 820 mm	1	1477K9GREY

Carro Premium E77

Carro robusto de 8 cajones con amortiguadores de protección individuales



BLACK
BLUE
RED

1477K8



976 x 510 x 820 mm	1	1477K8
976 x 510 x 820 mm	1	1477K8BLACK
976 x 510 x 820 mm	1	1477K8GREY

Carro Premium E77

Carro robusto de 7 cajones con amortiguadores de protección individuales



1477K7



976 x 510 x 820 mm	1	1477K7
976 x 510 x 820 mm	1	1477K7BLACK
976 x 510 x 820 mm	1	1477K7GREY

Carro Premium E77

Carro robusto de 6 cajones con amortiguadores de protección individuales



1477K6



976 x 510 x 820 mm	1	1477K6
976 x 510 x 820 mm	1	1477K6BLACK
976 x 510 x 820 mm	1	1477K6GREY

Carro E72

Carro robusto de 8 cajones con amortiguadores de protección



1472K8



952 x 510 x 782 mm	1	1472K8
952 x 510 x 782 mm	1	1472K8BLACK
952 x 510 x 782 mm	1	1472K8BLUE
952 x 510 x 782 mm	1	1472K8RED

Carro E72

Carro robusto de 7 cajones con amortiguadores de protección



1472K7



952 x 510 x 782 mm	1	1472K7
952 x 510 x 782 mm	1	1472K7BLACK
952 x 510 x 782 mm	1	1472K7BLUE
952 x 510 x 782 mm	1	1472K7RED

Carro E72

Carro robusto de 6 cajones con amortiguadores de protección



1472K6



952 x 510 x 782 mm	1	1472K6
952 x 510 x 782 mm	1	1472K6BLACK
952 x 510 x 782 mm	1	1472K6BLUE
952 x 510 x 782 mm	1	1472K6RED

Carro E72

Carro robusto de 5 cajones con amortiguadores de protección



1472K5



952 x 510 x 782 mm	1	1472K5
952 x 510 x 782 mm	1	1472K5BLACK
952 x 510 x 782 mm	1	1472K5BLUE
952 x 510 x 782 mm	1	1472K5RED

Carro Classic C75

Carro robusto 40" de 12 cajones



1475KXL12



986 x 501 x 1100 mm	1	1475KXL12
986 x 501 x 1100 mm	1	1475KXL12BLACK

Carro Classic C75
Carro robusto 40" de 6 cajones con armario lateral



1475KXL6C

986 x 501 x 1100 mm	1	1475KXL6C
986 x 501 x 1100 mm	1	1475KXL6CBLACK

Carro Classic C75
Carro robusto 40" de 6 cajones



1475KXL6

986 x 501 x 1100 mm	1	1475KXL6
986 x 501 x 1100 mm	1	1475KXL6BLACK
986 x 501 x 1100 mm	1	1475KXL6BLUE
986 x 501 x 1100 mm	1	1475KXL6RED

Carro Classic C75
Carro robusto de 6 cajones



1475K6

986 x 501 x 763 mm	1	1475K6
986 x 501 x 763 mm	1	1475K6BLACK
986 x 501 x 763 mm	1	1475K6BLUE
986 x 501 x 763 mm	1	1475K6RED

Carro Classic C75
Carro robusto 40" de 8 cajones



1475KXL8

986 x 501 x 1100 mm	1	1475KXL8
986 x 501 x 1100 mm	1	1475KXL8BLACK
986 x 501 x 1100 mm	1	1475KXL8BLUE
986 x 501 x 1100 mm	1	1475KXL8RED

Carro Classic C75
Carro robusto de 8 cajones



1475K8

986 x 501 x 763 mm	1	1475K8
986 x 501 x 763 mm	1	1475K8BLACK
986 x 501 x 763 mm	1	1475K8BLUE
986 x 501 x 763 mm	1	1475K8RED

Carro C75 extralargo
Carro de 53" con 8 cajones y armario lateral



1475KXXL8CWTS

1218 x 500 x 1505 mm	1089	1	1475KXXL8CWTS

Carro Classic C75
Carro robusto 40" de 7 cajones



1475KXL7

986 x 501 x 1100 mm	1	1475KXL7
986 x 501 x 1100 mm	1	1475KXL7BLACK
986 x 501 x 1100 mm	1	1475KXL7BLUE
986 x 501 x 1100 mm	1	1475KXL7RED

Carro Classic C75
Carro robusto de 7 cajones



1475K7

986 x 501 x 763 mm	1	1475K7
986 x 501 x 763 mm	1	1475K7BLACK
986 x 501 x 763 mm	1	1475K7BLUE
986 x 501 x 763 mm	1	1475K7RED

Cofre Premium E87
Cofre robusto de 4 cajones con amortiguadores de protección



1487K4

402 x 510 x 690 mm	1	1487K4
402 x 510 x 690 mm	1	1487K4BLACK
402 x 510 x 690 mm	1	1487K4GREY



Cofre Classic C85, 40"
Cofre robusto de 4 cajones



1485KXL4



417 x 500 x 1016 mm	1 1485KXL4
417 x 500 x 1016 mm	1 1485KXL4BLACK
417 x 500 x 1016 mm	1 1485KXL4BLUE
417 x 500 x 1016 mm	1 1485KXL4RED

Cofre Classic C85, 26"
Cofre robusto de 4 cajones



1485K4



417 x 500 x 677 mm	1 1485K4
417 x 500 x 677 mm	1 1485K4BLACK
417 x 500 x 677 mm	1 1485K4BLUE
417 x 500 x 677 mm	1 1485K4RED

Panel de herramientas superior lateral para 1477K



1477K-AC13



400 x 25 x 365 mm	1 1477K-AC13
-------------------	--------------

Soporte para chaquetas para 1477K



1477K-AC17



68 x 65 x 435 mm	1 1477K-AC17
------------------	--------------

Panel de herramientas para 1477K



1477K-AC12



396 x 25 x 610 mm	1 1477K-AC12
-------------------	--------------

Portadocumentos para 1477K



1477K-AC14



327 x 25 x 240 mm	1 1477K-AC14
-------------------	--------------

Porta rollos de papel para 1477K y 1472K



1477K-AC18



33 x 265 x 313 mm	1 1477K-AC18
-------------------	--------------

Soporte para documentación para 1477K y 1472K



1477K-AC19



241 x 65 x 300 mm	1 1477K-AC19
-------------------	--------------

Soporte para latas para 1477K y 1472K



1477K-AC20



125 x 105 x 307 mm	1 1477K-AC20
--------------------	--------------

Soporte para ordenador para 1477K



1477K-AC15

 mm	
80 x 298 x 424 mm	1 1477K-AC15

Soporte para lunas para 1477K



1477K-AC16

 mm	
106 x 115 x 208 mm	1 1477K-AC16

Panel de herramientas lateral para 1477K y 1472K



1477K-AC22

 mm	
659 x 18 x 300 mm	1 1477K-AC22

Tubo multifunción largo para 1477K



1477K-AC28

 mm	
455 x 25 x 25 mm	1 1477K-AC28

Tubo multifunción corto para 1477K



1477K-AC29

 mm	
130 x 25 x 25 mm	1 1477K-AC29

Cajón inferior para 1477K



1477K-AC10

 mm	
110 x 390 x 495 mm	1 1477K-AC10

Soporte para herramienta neumática para 1477K y 1472K



1477K-AC21

 mm	
115 x 175 x 302 mm	1 1477K-AC21

Sistema de bloqueo con código PIN



1477K-AC24

 mm	
135 x 36 x 62 mm	1 1477K-AC24

Sistema de Bloqueo MIFARE para 1477K



1477K-AC25

 mm	
135 x 36 x 62 mm	1 1477K-AC25

Encimera de composite para 1477K



1477K-AC2P

 mm	
45 x 508 x 547 mm	1 1477K-AC2P



Encimera con centro de madera para 1477K



1477K-ACTW

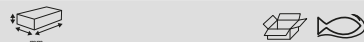

20 x 510 x 550 mm

1 1477K-ACTW

Bridas modulares para 1477K



1477K-AC11



30 x 39 x 68 mm

1 1477K-AC11

Set 7 alfombrillas protectoras para proteger los cajones 543x445



1470KAC1

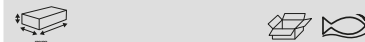

100 x 445 x 543 mm

1 1470KAC01

Encimera central para 1477K



1477K-ACTD



40 x 498 x 675 mm

1 1477K-ACTD

Encimera de madera de castaño para 1472K



1472K-ACTW

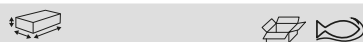

30 x 501 x 680 mm

1 1472K-ACTW

Bandeja plegable para carro



1470K-AC1

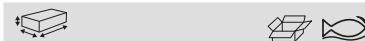

9 x 455 x 395 mm

1 1470K-AC1

Encimera central de acero inoxidable para 1477K



1477K-ACTSS



35 x 495 x 670 mm

1 1477K-ACTSS

Encimera de acero inoxidable para 1472K



1472K-ACTSS

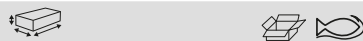

30 x 501 x 682 mm

1 1472K-ACTSS

Barra metálica de 23 agujeros para destornilladores



1470K-AC2



280 x 100 x 428 mm

1 1470K-AC2

Papel con pegatinas



1477K-AC23

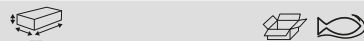

1 x 210 x 300 mm

1 1477K-AC23

Encimera MDF para 1472K



1472K-ACTD

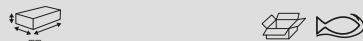

30 x 501 x 682 mm

1 1472K-ACTD

Accesorio lateral para carros 455x85x140mm



1470K-AC3

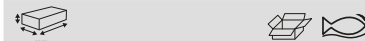

140 x 90 x 457 mm

1 1470K-AC3

Porta documentos para carros



1470K-AC4



180 x 83 x 360 mm

1 1470K-AC4

Panel metálico perforado para alojar herramientas



1470K-ACSIDE



20 x 418 x 822 mm

1 1470K-ACSIDE

Bandeja metálica ajustable para carros con armario en lateral



1470KXLC-TRAY



470 x 10 x 310 mm

1 1470KXLC-TRAY

Encimera de ABS para carros de 26"



1470K-AC7



45 x 497 x 674 mm

1 1470K-AC7

Encimera DM 26" y 40"



1470K-ACTD



40 x 495 x 1012 mm

1 1470KXL-ACTD

40 x 497 x 674 mm

1 1470K-ACTD

Carro dos bandejas



1470KC2



1051 x 435 x 764 mm

1 1470KC2

Panel perforado para carros 26"

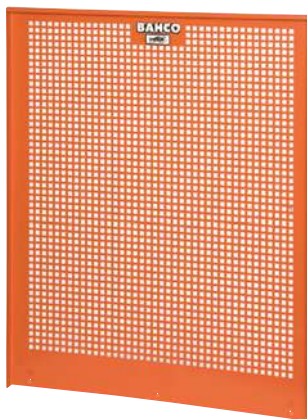

1470K-AC8



850 x 23 x 680 mm

1 1470K-AC8

850 x 25 x 680 mm

1 1470K-AC8GR

1470K-AC8GR : Gris

Encimera de Acero Inox 26" y 40"



1470K-ACTSS



40 x 495 x 1010 mm

1 1470KXL-ACTSS

38 x 495 x 670 mm

1 1470K-ACTSS

Carro tres bandejas



1470KC3



1051 x 435 x 764 mm

1 1470KC3

Encimera de madera de castaño



1470K-ACTW



40 x 500 x 1012 mm

1 1470KXL-ACTW

40 x 497 x 674 mm

1 1470K-ACTW



Carro 3 cajones + 2 bandejas



1470KC5



1051 x 435 x 1381 mm
1025 x 440 x 1315/880 mm



1 1470KC5
1 1470KC5PC

1470KC5PC: Negro

Bandeja central para 1470KC2



1470KCTRAY



750



420



1 1470KCTRAY

Transportador plegable con capacidad de 120 Kg



1430FT120



1077 x 520 x 487 mm



6.4 kg



1 1430FT120

COMPOSICIÓN DE HERRAMIENTAS EN FOAM

FF1E1001-7 piezas



FF1E1001



38 x 181 x 445 mm



1 FF1E1001

BE-8030, BE-8040, BE-8242, BE-8252



BE-8610, BE-8620, BE-8623



FF1E1002-7 piezas



FF1E1002



39 x 181 x 445 mm



1 FF1E1002

BE-8242



BE-8257



BE-8040



BE-8255



BE-8030



BE-8611, BE-8621



FF1E1003-6 piezas



FF1E1003



38 x 181 x 445 mm



1 FF1E1003

BE-8240



BE-8150, BE-8255, BE-8256



BE-8810, BE-8820



FF1E1004-8 piezas



FF1E1004



40 x 181 x 445 mm



1 FF1E1004

BE-8340, BE-8350



BE-8600, BE-8610



BE-8800, BE-8811, BE-8820L, BE-8821



FF1E1005-7 piezas



FF1E1005



40 x 181 x 445 mm



1 FF1E1005

BE-8210, BE-8010



BE-8811, BE-8821, BE-8800



BE-8600



BE-8830



FF1E1006-6 piezas



FF1E1006



40 x 181 x 445 mm



1 FF1E1006

BE-8210



BE-8610, BE-8620



BE-8630



BE-8811, BE-8820



FF1E1007-6 piezas



FF1E1007

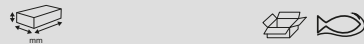

40 x 181 x 445 mm 1 FF1E1007

BE-8910, BE-8915, BE-8920, BE-8925, BE-8930, BE-8940

FF1E1008-6 piezas



FF1E1008



38 x 181 x 445 mm 1 FF1E1008

BE-7910, BE-7915, BE-7920, BE-7925, BE-7930, BE-7940

FF1E1009-6 piezas



FF1E1009



38 x 181 x 445 mm 1 FF1E1009

BE-8908, BE-8910, BE-8915, BE-8920, BE-8925, BE-8930

FF1E1010-6 piezas



FF1E1010

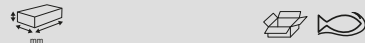

39 x 181 x 445 mm 1 FF1E1010

BE-8010S, BE-8230S, BE-8050S, BE-8255S

BE-8610S, BE-8620S

FF1E1011-6 piezas



FF1E1011

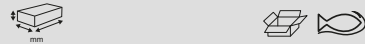

45 x 181 x 445 mm 1 FF1E1011

BE-8040S, BE-8050S, BE-8255S, BE-8065S

BE-8610S, BE-8620S

FF1E2001-37 piezas



FF1E2001



38 x 181 x 445 mm 1 FF1E2001

6700SM-10, 6700SM-11, 6700SM-14, 6700SM-13, 6700SM-12, 6700SM-4, 6700SM-9, 6700SM-8, 6700SM-7, 6700SM-6, 6700SM-5.5, 6700SM-5

6700TORX-E10, 6700TORX-E8, 6700TORX-E7, 6700TORX-E6, 6700TORX-E5, 6700TORX-E4

6709M-8, 6709M-6, 6709M-5, 6709M-4, 6709M-3

6709TORX-T20, 6709TORX-T15, 6709TORX-T10, 6709TORX-T40, 6709TORX-T30, 6709TORX-T27, 6709TORX-T25, 6709TORX-T8, 6709TORX-T9

6950SL

6954

6956

6960

6966

FF1E2002-45 piezas



FF1E2002



38 x 181 x 445 mm 1 FF1E2002

6700SM-4, 6700SM-4.5, 6700SM-5, 6700SM-5.5, 6700SM-6, 6700SM-7, 6700SM-8, 6700SM-9, 6700SM-10, 6700SM-11, 6700SM-12, 6700SM-13, 6700SM-14

6709PZ-1, 6709PZ-3, 6709PZ-2

6709PH-1, 6709PH-2, 6709PH-3

6709TORX-T10, 6709TORX-T15, 6709TORX-T20, 6709TORX-T25, 6709TORX-T30, 6709TORX-T40

6709F-4.5, 6709F-5.5, 6709F-8

6709M-3, 6709M-4, 6709M-5, 6709M-6, 6709M-8

1998M-3, 1998M-2.5, 1998M-2, 1998M-1.5

6950SL

6962-W

6966

6956

6960, 6961

7765

6954















FF1E2003-27 piezas



FF1E2003



 38 x 181 x 445 mm  1 FF1E2003











6700SM-14, 6700SM-13, 6700SM-12, 6700SM-11, 6700SM-10, 6700SM-9, 6700SM-8, 6700SM-7, 6700SM-6, 6700SM-5.5, 6700SM-5	 
BE-9778	 
6950SL	
6956	
6962	
6966	
7765	
6954	
1997M-12	 

FF1E2004-48 piezas



FF1E2004



 44 x 181 x 445 mm  1 FF1E2004









A6700DM-14, A6700DM-13, A6700DM-12, A6700DM-11, A6700DM-10, A6700DM-9, A6700DM-8, A6700DM-7, A6700DM-6, A6700DM-5.5, A6700DM-5	 
808050S	
6950SL	
6966	
6972H	
6962	
7765	
59S/31-1	 

FF1E2005-17 piezas



FF1E2005



 35 x 181 x 445 mm  1 FF1E2005



















6700SM-14, 6700SM-13, 6700SM-12, 6700SM-11, 6700SM-10, 6700SM-9, 6700SM-8, 6700SM-7, 6700SM-6, 6700SM-5.5	 
6950RN	
6962	
6966	
6960	
6954	
6956	
6972H	

FF1E2006-35 piezas



FF1E2006

 39 x 181 x 445 mm  1 FF1E2006











6700SZ-5/16, 6700SZ-5/32, 6700SZ-11/32, 6700SZ-7/16, 6700SZ-9/32, 6700SZ-3/16, 6700SZ-3/8, 6700SZ-7/32, 6700SZ-1/4, 6700SZ-1/2, 6700SZ-9/16	 
6709PZ-1, 6709PZ-2, 6709PZ-3	 
6709PH-1, 6709PH-2, 6709PH-3	 
6709TORX-T8, 6709TORX-T10, 6709TORX-T15, 6709TORX-T20, 6709TORX-T25, 6709TORX-T30	 
6709F-4.5, 6709F-6.5, 6709F-8	 
6950RN	
6954	
6972H	
6960, 6962	
6963	
6966	
6956	
7765	

FF1E2007-24 piezas



FF1E2007

 35 x 181 x 445 mm  1 FF1E2007











6700SZ-9/32, 6700SZ-3/16, 6700SZ-3/8, 6700SZ-1/4, 6700SZ-7/16, 6700SZ-7/32, 6700SZ-1/2, 6700SZ-11/32	 
1995Z-5/64, 1995Z-5/32, 1995Z-3/8, 1995Z-3/32, 1995Z-7/32, 1995Z-1/8, 1995Z-5/16, 1995Z-3/16, 1995Z-1/4	 
6950RN	
6954	
6972H	
6960, 6962	
6956	
6966	

FF1E2008-26 piezas



FF1E2008

 35 x 181 x 445 mm  1 FF1E2008

6700SM-5.5, 6700SM-8, 6700SM-7, 6700SM-6, 6700SM-12, 6700SM-11, 6700SM-10, 6700SM-9, 6700SM-14, 6700SM-13	 
1995M-3, 1995M-2, 1995M-7, 1995M-6, 1995M-5, 1995M-4, 1995M-10, 1995M-9, 1995M-8	 
6950RN	
6960, 6962	
6966	
6954	
6956	
6972H	

FF1E2101-24 piezas



FF1E2101

40 x 181 x 445 mm	1 FF1E2101

7400SM-8, 7400SM-7, 7400SM-6, 7400SM-12, 7400SM-11, 7400SM-10, 7400SM-9, 7400SM-22, 7400SM-16, 7400SM-15, 7400SM-14, 7400SM-13, 7400SM-20, 7400SM-19, 7400SM-18, 7400SM-17		
7750SL		
7760, 7761, 7762		
7764		
7766		
7754		
8164-1/2		

FF1E2102-25 piezas



FF1E2102

38 x 181 x 445 mm	1 FF1E2102

7400SM-8, 7400SM-7, 7400SM-6, 7400SM-12, 7400SM-11, 7400SM-10, 7400SM-9, 7400SM-16, 7400SM-15, 7400SM-14, 7400SM-13, 7400SM-19, 7400SM-18, 7400SM-17		
7409M-5, 7409M-4, 7409M-10, 7409M-8, 7409M-6		
7750SL		
7760, 7762		
7754		
7768		
8164-1/2		

FF1E2103-28 piezas



FF1E2103

38 x 181 x 445 mm	1 FF1E2103

7400SM-8, 7400SM-7, 7400SM-12, 7400SM-11, 7400SM-10, 7400SM-9, 7400SM-22, 7400SM-21, 7400SM-16, 7400SM-15, 7400SM-14, 7400SM-13, 7400SM-20, 7400SM-19, 7400SM-18, 7400SM-17		
7400TORX-E10, 7400TORX-E8, 7400TORX-E18, 7400TORX-E16, 7400TORX-E14, 7400TORX-E12		
7750SL		
7760, 7762		
7768		
7766		
SBS705		

FF1E2104-20 piezas



FF1E2104

38 x 181 x 445 mm	1 FF1E2104

7400SM-8, 7400SM-6, 7400SM-12, 7400SM-11, 7400SM-10, 7400SM-9, 7400SM-22, 7400SM-16, 7400SM-15, 7400SM-14, 7400SM-13, 7400SM-20, 7400SM-19, 7400SM-18, 7400SM-17		
7750RN		
7761, 7762		
7766		
7768		

FF1E2105-28 piezas



FF1E2105

35 x 181 x 445 mm	1 FF1E2105

7400TORX-E18, 7400TORX-E10, 7400TORX-E8, 7400TORX-E16, 7400TORX-E14, 7400TORX-E12, 7400TORX-E11		
7409TORX-T50, 7409TORX-T45, 7409TORX-T40, 7409TORX-T30		
7409TORX-T25-L, 7409TORX-T50-L		
7409TORX-T25		
7409TORX-T45-L, 7409TORX-T40-L, 7409TORX-T30-L		
7409M-5, 7409M-4, 7409M-10, 7409M-8, 7409M-6		
7409F-10, 7409F-8, 7409F-6.5		
7409PH-1, 7409PH-2, 7409PH-3		

FF1E2201-21 piezas



FF1E2201

44 x 181 x 445 mm	1 FF1E2201

7800SM-11, 7800SM-10, 7800SM-15, 7800SM-13, 7800SM-12, 7800SM-19, 7800SM-17, 7800SM-14, 7800SM-18, 7800SM-22, 7800SM-21, 7800SM-20, 7800SM-27, 7800SM-24		
7805SM-16, 7805SM-21		
8150SL		
8162-1/2, 8160-1/2		
8166-1/2		
8165-1/2		



FF1E2202-21 piezas



FF1E2202

45 x 181 x 445 mm	1	FF1E2202

7800SM-9, 7800SM-8, 7800SM-10, 7800SM-11, 7800SM-12, 7800SM-15, 7800SM-14, 7800SM-13, 7800SM-19, 7800SM-17, 7800SM-16, 7800SM-18, 7800SM-23, 7800SM-21, 7800SM-20, 7800SM-27, 7800SM-24		
8150-1/2		
8160-1/2, 8162-1/2		
8166-1/2		

FF1E2204-15 piezas



FF1E2204

45 x 181 x 445 mm	1	FF1E2204

7800DZ-1/2, 7800DZ-3/4, 7800DZ-19/32, 7800DZ-7/8, 7800DZ-7/16, 7800DZ-11/16, 7800DZ-9/16, 7800DZ-13/16, 7800DZ-3/8, 7800DZ-5/8, 7800DZ-15/16		
8150RN-1/2		
8160-1/2, 8162-1/2		
8166-1/2		

FF1E2206-27 piezas



FF1E2206

50 x 181 x 445 mm	1	FF1E2206

7800SM-11, 7800SM-10, 7800SM-15, 7800SM-14, 7800SM-13, 7800SM-12, 7800SM-19, 7800SM-18, 7800SM-17, 7800SM-16, 7800SM-23, 7800SM-22, 7800SM-21, 7800SM-20, 7800SM-27, 7800SM-26, 7800SM-25, 7800SM-24, 7800SM-28, 7800SM-32, 7800SM-30		
7809XZN-8, 7809XZN-10		
7809PZ-3, 7809PZ-2		
7809F-10, 7809F-8		

FF1E2203-22 piezas



FF1E2203

50 x 181 x 445 mm	1	FF1E2203

7800SM-8, 7800SM-9, 7800SM-11, 7800SM-10, 7800SM-15, 7800SM-14, 7800SM-13, 7800SM-12, 7800SM-19, 7800SM-18, 7800SM-17, 7800SM-16, 7800SM-22, 7800SM-21, 7800SM-27, 7800SM-24, 7800SM-32, 7800SM-30		
8150RN-1/2		
8160-1/2, 8162-1/2		
8166-1/2		

FF1E2205-28 piezas



FF1E2205

50 x 181 x 445 mm	1	FF1E2205

7800DM-10, 7800DM-11, 7800DM-12, 7800DM-13, 7800DM-14, 7800DM-15, 7800DM-16, 7800DM-17, 7800DM-18, 7800DM-19, 7800DM-20, 7800DM-21, 7800DM-22, 7800DM-23, 7800DM-24, 7800DM-25, 7800DM-26, 7800DM-27, 7800DM-28, 7800DM-30, 7800DM-32		
7809M-10, 7809M-12, 7809M-14, 7809M-6, 7809M-7, 7809M-8, 7809M-9		

FF1E2207-25 piezas



FF1E2207

40 x 181 x 445 mm	1	FF1E2207



7809TORX-T60, 7809TORX-T55, 7809TORX-T25, 7809TORX-T20, 7809TORX-T40, 7809TORX-T30, 7809TORX-T27, 7809TORX-T50, 7809TORX-T45		
7800TORX-E18, 7800TORX-E16, 7800TORX-E14, 7800TORX-E12, 7800TORX-E24, 7800TORX-E20, 7800TORX-E10, 7800TORX-E8		
BE-9675		

FF1E2208-12 piezas



FF1E2208

 35 x 181 x 445 mm
  1 FF1E2208















- | | | |
|--|---|---|
| 7809M-9, 7809M-8, 7809M-6, 7809M-7, 7809M-17, 7809M-14, 7809M-12, 7809M-10 |  |  |
| 7809M-10-140, 7809M-5-180, 7809M-6-140, 7809M-8-120 | |  |

FF1E2209-20 piezas



FF1E2209

 35 x 181 x 445 mm
  1 FF1E2209









- | | | |
|--|---|---|
| 7809M-5, 7809M-8, 7809M-7, 7809M-6, 7809M-17, 7809M-14, 7809M-12, 7809M-10 |  |  |
| 7809TORX-T27 |  |  |
| 7809XZN-10 |  |  |
| 7809TORX-T25 |  |  |
| 7809XZN-12 |  |  |
| 7809TORX-T60, 7809TORX-T40, 7809TORX-T30, 7809TORX-T55, 7809TORX-T50, 7809TORX-T45 |  |  |
| 7809XZN-6, 7809XZN-8 |  |  |

FF1E2210-14 piezas



FF1E2210

 38 x 181 x 445 mm
  1 FF1E2210







- | | | |
|--|--|---|
| 7809M-5, 7809M-8, 7809M-7, 7809M-6, 7809M-19, 7809M-17, 7809M-14, 7809M-12, 7809M-10 |  |  |
| BE-7606 |  |  |
| BWSS12P319, BWSS12P321, BWS-S12P317 |  |  |
| BE-7607 |  |  |

FF1E2211-21 piezas



FF1E2211

 50 x 181 x 445 mm
  1 FF1E2211



- | | | |
|---|---|--|
| 7993S0050, 7993S0060, 7993S0080, 7993S0100, 7993S0120, 7993S0140, 7993S0170, 7993S0190 |  |  |
| 7994S0300, 7994S0400, 7994S0450, 7994S0500, 7994S0550, 7994S0600 |  |  |
| K7801TORX-E10, K7801TORX-E12, K7801TORX-E14, K7801TORX-E16, K7801TORX-E18, K7801TORX-E20, K7801TORX-E24 |  |  |

FF1E2212-12 piezas



FF1E2212

 40 x 181 x 445 mm
  1 FF1E2212



- | | | |
|--|---|---|
| K7801M-10, K7801M-12, K7801M-13, K7801M-14, K7801M-15, K7801M-16, K7801M-17, K7801M-18, K7801M-19, K7801M-21, K7801M-22, K7801M-24 |  |  |
|--|---|---|

FF1E2213-15 piezas



FF1E2213

 45 x 181 x 445 mm
  1 FF1E2213

- | | | |
|---|---|---|
| K7806M-10, K7806M-12, K7806M-13, K7806M-14, K7806M-15, K7806M-16, K7806M-17, K7806M-18, K7806M-19, K7806M-21, K7806M-22, K7806M-24, K7806M-27, K7806M-30, K7806M-32 |  |  |
|---|---|---|



FF1E2501-13 piezas







FF1E2501





 35 x 181 x 445 mm 1 FF1E2501

- A7402DM-14, A7402DM-13, A7402DM-12, A7402DM-11, A7402DM-10  
- 7805SM-12, 7805SM-13, 7805SM-14, 7805SM-15, 7805SM-16, 7805SM-17, 7805SM-18, 7805SM-19  

FF1E2502-7 piezas







FF1E2502





 45 x 181 x 445 mm 1 FF1E2502

- K560F-4, K560F-5 
- K8167S 
- K8160D-1, K8160D-2 
- K7764D, K8964D 

FF1E3001-9 piezas



FF1E3001







 47 x 181 x 445 mm 1 FF1E3001

- 6M-10-11, 6M-12-13, 6M-14-15, 6M-16-17, 6M-18-19, 6M-21-23, 6M-22-24, 6M-6-7, 6M-8-9 

FF1E3002-3 piezas



FF1E3002

 35 x 181 x 445 mm 1 FF1E3002

- 6M-25-28, 6M-27-29, 6M-30-32 

FF1E3003-9 piezas



FF1E3003





 41 x 181 x 445 mm 1 FF1E3003

- 6Z-1/2-9/16, 6Z-1/4-5/16, 6Z-15/16-1, 6Z-19/32-11/16, 6Z-25/32-13/16, 6Z-3/4-7/8, 6Z-3/8-7/16, 6Z-5/16-11/32, 6Z-5/8-3/4 

FF1E3004-10 piezas





FF1E3004





 39 x 181 x 445 mm 1 FF1E3004

- 1RM-10, 1RM-11, 1RM-12, 1RM-13, 1RM-14, 1RM-15, 1RM-16, 1RM-17, 1RM-8, 1RM-9  

FF1E3005-40 piezas









FF1E3005





 42 x 181 x 445 mm 1 FF1E3005

- 59S/31-1  
- 6966 
- 41RM-14, 41RM-13, 41RM-12, 41RM-10, 41RM-8, 41RM-19, 41RM-17  
- 8166-1/2 

FF1E3006-8 piezas





FF1E3006





 35 x 181 x 445 mm 1 FF1E3006



- 1320RM-10-11, 1320RM-12-13, 1320RM-14-15, 1320RM-16-17, 1320RM-18-19, 1320RM-22-24, 1320RM-6-7, 1320RM-8-9  

FF1E3007-7 piezas



FF1E3007

 35 x 181 x 445 mm   1 FF1E3007



2M-10-11, 2M-12-13, 2M-14-15, 2M-16-17, 2M-18-19, 2M-6-7, 2M-8-9  

FF1E3008-9 piezas



FF1E3008

 50 x 181 x 445 mm   1 FF1E3008





27M-10-11, 27M-12-13, 27M-14-15, 27M-16-17, 27M-18-19, 27M-20-22, 27M-21-23, 27M-24-27, 27M-8-9  

FF1E4001-4 piezas



FF1E4001

 35 x 181 x 445 mm   1 FF1E4001





2628 G-180IP 
 8231 IP 
 2430 G-200 IP 
 2101G-160IP 

FF1E4002-4 piezas



FF1E4002

 35 x 181 x 445 mm   1 FF1E4002







2900-180 
 2890-180 
 2990-180 
 2800-180 

FF1E5001-7 piezas



FF1E5001

 45 x 181 x 445 mm   1 FF1E5001





MTB-5-25 
 8045LVDE 
 WR2-MM 
 1544 
 1178-SCRIBE 
 5515T 
 1150D 

FF1E5002-11 piezas



FF1E5002

 35 x 181 x 445 mm   1 FF1E5002





3740-175, 3740-150, 3740-200 
 3734-5, 3734-4, 3734-3, 3734-2, 3734-8, 3734-6 
 481-100 
 1157 

FF1E5003-11 piezas



FF1E5003

 35 x 181 x 445 mm   1 FF1E5003



481-300 
 3735-5-120 
 3739-300 
 3740-125, 3740-100, 3740-150, 3740-200 
 3733-2, 3733-3, 3733-4, 3733-5 

FF1E5004-35 piezas



FF1E5004

 36 x 181 x 445 mm   1 FF1E5004

481-400 
 3734S/6 
 7865 



FF1E5005-35 piezas



FF1E5005

36 x 181 x 445 mm 1 FF1E5005

BWTSP16
1418S

FF1E5006-6 piezas



FF1E5006

42 x 181 x 445 mm 1 FF1E5006

D/S14
BWSS12P3
BWTB12P110, BWTB12P120

FF1E5007-3 piezas



FF1E5007

38 x 181 x 445 mm 1 FF1E5007

1410
9033
8225

FF1E5008-4 piezas



FF1E5008

37 x 181 x 445 mm 1 FF1E5008

7805ZZ-16, 7805ZZ-21
BE1P
BE61110

FF1E5009-17 piezas



FF1E5009

36 x 181 x 445 mm 1 FF1E5009

BE6217

FF1F1001-8 piezas



FF1F1001

40 x 362 x 445 mm 1 FF1F1001

BE-8210, BE-8030, BE-8040, BE-8240,
BE-8242, BE-8252, BE-8250L
BE-8255, BE-8257

FF1F1002-11 piezas



FF1F1002

40 x 362 x 445 mm 1 FF1F1002

BE-8020
BE-8330
BE-8040, BE-8242, BE-8252
BE-8256, BE-8258
BE-8610
BE-8602
BE-8620, BE-8623

FF1F1003-11 piezas



FF1F1003

38 x 362 x 445 mm 1 FF1F1003

BE-8030, BE-8242
BE-8155
BE-8252
BE-8870
BE-8600, BE-8610, BE-8620, BE-8623,
BE-8624
808050TS

FF1F1004-10 piezas



FF1F1004



38 x 362 x 445 mm 1 FF1F1004

- BE-8904, BE-8907, BE-8908
- BE-7910, BE-7915, BE-7920, BE-7925, BE-7927, BE-7930, BE-7940

FF1F1005-42 piezas



FF1F1005



43 x 362 x 445 mm 1 FF1F1005

- BE-8908, BE-8909, BE-8910, BE-8915, BE-8920, BE-8925, BE-8927, BE-8930
- K6650-1/4-1P
- 808050S
- 808050
- 59S/31-3

FF1F1006-8 piezas



FF1F1006



40 x 362 x 445 mm 1 FF1F1006

- BE-8230S, BE-8040S, BE-8050S, BE-8255S
- BE-8810S, BE-8820S
- BE-8610S, BE-8620S

FF1F1007-7 piezas



FF1F1007



35 x 362 x 445 mm 1 FF1F1007

- 901T-010-100, 901T-015-150, 901T-020-150, 901T-025-150, 901T-027-150, 901T-030-200, 901T-040-200

FF1F1008-49 piezas



FF1F1008



38 x 362 x 445 mm 1 FF1F1008

- B219.026
- B705.1/4.125
- B146.006.100
- B145.006.100
- BE-9770
- 59S/31-1

FF1F1009-14 piezas



FF1F1009



38 x 362 x 445 mm 1 FF1F1009

- B219.026
- B219.025
- B196.030.100
- B195.002.025
- B195.050.025

FF1F2001-44 piezas



FF1F2001



37 x 362 x 445 mm 1 FF1F2001

- A6800DM-11, A6800DM-10, A6800DM-9, A6800DM-8, A6800DM-13, A6800DM-12, A6800DM-4, A6800DM-7, A6800DM-6, A6800DM-5.5, A6800DM-5
- 6700SM-8, 6700SM-7, 6700SM-6, 6700SM-5.5, 6700SM-12, 6700SM-11, 6700SM-10, 6700SM-9, 6700SM-14, 6700SM-5, 6700SM-13
- 6709PH-2, 6709PH-1, 6709PH-3
- 6709PZ-2, 6709PZ-1
- 6709M-5, 6709M-4, 6709M-3, 6709M-8, 6709M-6
- 6709F-5.5, 6709F-4.5, 6709F-8
- BE-9778
- 6950SL
- 7765
- 6954
- 6962
- 6966
- 6972H
- 6956
- 1997M-12







FF1F2002-53 piezas



FF1F2002

 45 x 362 x 445 mm
   1 FF1F2002

- SL25L 
- 2058/S26 
- 6956 
- 1419-MD 

FF1F2101-36 piezas



FF1F2101

 37 x 362 x 445 mm
   1 FF1F2101

- 7400SM-8, 7400SM-7, 7400SM-12, 7400SM-11, 7400SM-10, 7400SM-9, 7400SM-22, 7400SM-21, 7400SM-16, 7400SM-15, 7400SM-14, 7400SM-13, 7400SM-20, 7400SM-19, 7400SM-18, 7400SM-17 
- 7409M-8, 7409M-4, 7409M-6, 7409M-10 
- A7402DM-13, A7402DM-12, A7402DM-11, A7402DM-10 
- A7410DZ-5/16, A7410DZ-7/16, A7410DZ-9/16, A7410DZ-3/8, A7410DZ-5/8 
- 7750SL 
- 7762 
- 7754 
- 7766 
- 7764 
- 7757 
- 8164-1/2 

FF1F2102-34 piezas



FF1F2102

 40 x 362 x 445 mm
   1 FF1F2102

- S330L 

FF1F2103-38 piezas



FF1F2103

 35 x 362 x 445 mm
   1 FF1F2103

- S380 

FF1F2201-35 piezas



FF1F2201

 50 x 362 x 445 mm
   1 FF1F2201

- 7800SM-13, 7800SM-12, 7800SM-19, 7800SM-18, 7800SM-10, 7800SM-17, 7800SM-22, 7800SM-21, 7800SM-20, 7800SM-27, 7800SM-24, 7800SM-32, 7800SM-30 

- 7800DM-16, 7800DM-15, 7800DM-14, 7800DM-13, 7800DM-19, 7800DM-18, 7800DM-17, 7800DM-12, 7800DM-11, 7800DM-10 

- 7809M-5, 7809M-6, 7809M-7, 7809M-8, 7809M-12, 7809M-10 

- 8150SL 

- 8160-1/2 

- 8166-1/2 

- 8154-1/2 

- 8165-1/2 

- 8162-1/2 

FF1F2202-24 piezas



FF1F2202

 50 x 362 x 445 mm
   1 FF1F2202

- S240 

- S81SL 

FF1F2203-27 piezas



FF1F2203

 50 x 362 x 445 mm
   1 FF1F2203

K7801M-17, K7801M-18, K7801M-19,
K7801M-21, K7801M-22, K7801M-24,
K7801M-10, K7801M-12, K7801M-13,
K7801M-14, K7801M-15, K7801M-16



K7806M-10, K7806M-12, K7806M-13,
K7806M-14, K7806M-15, K7806M-16,
K7806M-17, K7806M-18, K7806M-19,
K7806M-21, K7806M-22, K7806M-24,
K7806M-27, K7806M-30, K7806M-32



FF1F3001-11 piezas



FF1F3001

40 x 362 x 445 mm 1 FF1F3001

6M-10-11, 6M-12-13, 6M-14-15, 6M-16-18, 6M-17-19, 6M-20-22, 6M-21-23, 6M-24-27, 6M-30-32, 6M-6-7, 6M-8-9

FF1F3002-18 piezas



FF1F3002

41 x 362 x 445 mm 1 FF1F3002

111M-10, 111M-11, 111M-12, 111M-13, 111M-14, 111M-15, 111M-16, 111M-17, 111M-18, 111M-19, 111M-21, 111M-22, 111M-24, 111M-27, 111M-6, 111M-7, 111M-8, 111M-9

FF1F3003-30 piezas



FF1F3003

40 x 362 x 445 mm 1 FF1F3003

111M-6, 111M-7, 111M-8, 111M-9, 111M-17, 111M-16, 111M-15, 111M-14, 111M-19, 111M-18, 111M-13, 111M-12, 111M-11, 111M-10, 111M-21, 111M-20, 111M-22

1320SRM-14-19
1RMA-19-1/4-SQ
1RMA-13-10-BIT
BE-9778

FF1F3004-13 piezas



FF1F3004

42 x 362 x 445 mm 1 FF1F3004

111Z-1, 111Z-1/2, 111Z-1/4, 111Z-11/16, 111Z-13/16, 111Z-15/16, 111Z-3/4, 111Z-3/8, 111Z-5/16, 111Z-5/8, 111Z-7/16, 111Z-7/8, 111Z-9/16

FF1F3005-15 piezas



FF1F3005

39 x 362 x 445 mm 1 FF1F3005

1RM-8, 1RM-19, 1RM-10, 1RM-14,
1RM-13, 1RM-12, 1RM-18, 1RM-17,
1RM-16, 1RM-15, 1RM-22, 1RM-21
1RMA-13-10-BIT

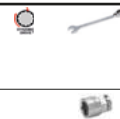

FF1F3006-7 piezas



FF1F3006

35 x 362 x 445 mm 1 FF1F3006

1RM-19, 1RM-21, 1RM-22, 1RM-24,
1RM-27, 1RM-30

FF1F3007-10 piezas



FF1F3007

47 x 362 x 445 mm 1 FF1F3007

2M-10-11, 2M-12-13, 2M-14-15, 2M-16-18, 2M-17-19, 2M-21-23, 2M-24-27, 2M-30-32, 2M-6-7, 2M-8-9



FF1F3008-9 piezas



FF1F3008

38 x 362 x 445 mm 1 FF1F3008

4040M-10-11, 4040M-12-13, 4040M-14-15, 4040M-16-17, 4040M-18-19, 4040M-20-22, 4040M-21-23, 4040M-6-7, 4040M-8-9

FF1F3009-8 piezas



FF1F3009

35 x 362 x 445 mm 1 FF1F3009

1949M-10-11, 1949M-12-13, 1949M-14-15, 1949M-17-19, 1949M-19-22, 1949M-24-27, 1949M-30-32, 1949M-8-9

FF1F3010-17 piezas



FF1F3010

35 x 362 x 445 mm 1 FF1F3010

1RM/S5 111M/SH12

FF1F3011-13 piezas



FF1F3011

35 x 362 x 445 mm 1 FF1F3011

S4RM/3T 111M/SH12

FF1F4001-8 piezas



FF1F4001

35 x 362 x 445 mm 1 FF1F4001

2430 G-160 IP 2421 G-180 IP 2101G-160IP 2628 G-200 8224 IP 9029 2951-140, 2951-300

FF1F4002-8 piezas



FF1F4002

35 x 362 x 445 mm 1 FF1F4002

2928-160	
2951-250	
SC127	
2101G-160IP	
2430 G-160 IP	
2339 DIP	
2628 G-180IP	
8224 IP	

FF1F4003-4 piezas



FF1F4003

35 x 362 x 445 mm 1 FF1F4003

2101G-160IP	
8224 IP	
2951-180	
2430 G-200 IP	

FF1F4004-8 piezas



FF1F4004

35 x 362 x 445 mm 1 FF1F4004

2800-140, 2800-180	
2890-140, 2890-180	
2900-140, 2900-180	
2990-140, 2990-180	

FF1F4005-5 piezas



FF1F4005

38 x 362 x 445 mm	1 FF1F4005

2101S-160	
2430 S-200	
2427 S-200	
8224 IP	
2628 S-180	

FF1F5001-10 piezas



FF1F5001

40 x 362 x 445 mm	1 FF1F5001

1-100-08-1-2	
1-160-08-1-2	
1-170-08-1-2	
1-210-08-1-2	
1-230-08-1-2	
2430 G-200 IP	
2628G-200IP	
7224	
2101G-160IP	
MTB-3-16	

FF1F5002-5 piezas



FF1F5002

38 x 362 x 445 mm	1 FF1F5002

2681	
MA401	
MA411	
1178-SCRIBE	
MTG-5-19	

FF1F5003-5 piezas



FF1F5003

35 x 362 x 445 mm	1 FF1F5003

8224	
2101G-160	
2430 G-160	
8071	
2951-250	

FF1F5004-50 piezas



FF1F5004

35 x 362 x 445 mm	1 FF1F5004

BE5049

1419-MD



FF1F5005-8 piezas



FF1F5005

40 x 362 x 445 mm	1 FF1F5005

317	
3906-300-24-5P	
268	
2446	

FF1F5006-4 piezas



FF1F5006

50 x 362 x 445 mm	1 FF1F5006

CR W 01	
CR B 05	
3418 A	
BMMTRMS1	





FF1F5007-5 piezas



FF1F5007

 45 x 362 x 445 mm   1 FF1F5007





- 4543-1, 4543-2, 4543-3 
- 4545-2 
- 4541-A 

FF1F5008-11 piezas



FF1F5008

 37 x 362 x 445 mm   1 FF1F5008





- 2633/S4, 2633L/S4 
- 2489 
- 2485 
- KE18-01 

FF1F5009-5 piezas



FF1F5009

 60 x 362 x 445 mm   1 FF1F5009







- BS618, BS623 
- 4545-2 
- 4545-N11 
- 4532-0 

FF1F5010-9 piezas



FF1F5010

 45 x 362 x 445 mm   1 FF1F5010





- BBR6135 
- BBR6131 
- BBR110 
- 1949M-8-9, 1949M-10-11 
- 7809M-6, 7809M-8, 7809M-10 
- 783 

FF1F5011-7 piezas



FF1F5011

 100 x 362 x 445 mm   1 FF1F5011







- BP815 
- BP821 
- BP822 
- BP823 

FF1F5012-9 piezas



FF1F5012

 55 x 362 x 445 mm   1 FF1F5012

- BWSS12P317, BWSS12P319, BWS-S12P321 
- BPC814 
- BWTB12P120 
- GL008-10 
- 783 
- 8158-1/2 

FF1F5013-39 piezas



FF1F5013

 35 x 362 x 445 mm   1 FF1F5013



- BS1000 

FF1A54 - 75 piezas



FF1A54

 35 x 543 x 445 mm   1 FF1A54

S1612L	
S0810L	
S330L	

FF1A01 - 77 piezas



FF1A01

	
45 x 543 x 445 mm	1 FF1A01









A6800DM-6, A6800DM-7, A6800DM-8, A6800DM-9, A6800DM-10, A6800DM-11, A6800DM-12, A6800DM-13, A6800DM-4, A6800DM-5		
6700SM-4.5, 6700SM-5, 6700SM-5.5, 6700SM-6, 6700SM-7, 6700SM-8		
59S/22-1		
6700SM-9, 6700SM-10, 6700SM-11, 6700SM-12, 6700SM-13, 6700SM-4		
6950SL		
6954		
6956		
6960, 6961		
6966		
6972H		
7800SM-18, 7800SM-19, 7800SM-10, 7800SM-11, 7800SM-12, 7800SM-13, 7800SM-14, 7800SM-15, 7800SM-16, 7800SM-17, 7800SM-22, 7800SM-27, 7800SM-24, 7800SM-30, 7800SM-32		
7805ZZ-21		
7807H		
B191.040.100, B191.055.150		
B192.001.100, B192.002.125		
8150SL		
8154-1/2		
8159-1/2, 8162-1/2		
8166-1/2		

FF1A02 - 25 piezas



FF1A02

	
45 x 543 x 445 mm	1 FF1A02



















111M-12, 111M-13, 111M-14, 111M-17, 111M-19, 111M-22, 111M-6, 111M-7, 111M-8, 111M-10		
6M-6-7, 6M-8-9		
808050L		
6M-10-11, 6M-12-13, 6M-14-15, 6M-16-17, 6M-18-19, 6M-20-22		

FF1A03 - 18 piezas



FF1A03

	
50 x 543 x 445 mm	1 FF1A03









BE-9770		
MTB-5-25		
3734N-4-150, 3734N-6-150		
1-100-08-2-2		
2171G-160		
2971G-250		
481-400		
2678 G-160		
306		

FF1A04 - 30 piezas



FF1A04

	
50 x 543 x 445 mm	1 FF1A04













































S4RM-12-15, S4RM-16-19, S4RM-8-11		
111M-30, 111M-32, 111M-6, 111M-7, 111M-8, 111M-9, 111M-10, 111M-11, 111M-12, 111M-13, 111M-14, 111M-15, 111M-16, 111M-17, 111M-18, 111M-19, 111M-21, 111M-22, 111M-24, 111M-27		
6M-10-11, 6M-12-13, 6M-14-15, 6M-17-19, 6M-6-7, 6M-8-9		
9071C		

FF1A05 - 109 piezas



FF1A05

	
50 x 543 x 445 mm	1 FF1A05

BE-9678		
SBS60-4, SBS60-7, SBS60-8, SBS60-9, SBS60-10, SBS60-11, SBS60-12, SBS60-13, SBS60-14, SBS60-4.5, SBS60-5, SBS60-5.5, SBS60-6		
SBS61		
SBS63-2, SBS63-4, SBS63-6		
SBS64		
SBS65		
SBS67		
SBS69		
SBS80-13, SBS80-14, SBS80-15, SBS80-16, SBS80-17, SBS80-18, SBS80-19, SBS80-10, SBS80-11, SBS80-12, SBS80-22, SBS80-24, SBS80-27, SBS80-21, SBS80-30, SBS80-32		
SBS88		
6956		
6972H		
7809M-12, 7809M-14, 7809M-17		
59S/31-1		
7809M-5, 7809M-19, 7809M-6, 7809M-7, 7809M-8, 7809M-10		
7809TORX-T50, 7809TORX-T55, 7809TORX-T60, 7809TORX-T20, 7809TORX-T25, 7809TORX-T27, 7809TORX-T30, 7809TORX-T40, 7809TORX-T45		
808050		
8150SL		
8154-1/2		
8160-W		
8162-1/2		
8166-1/2		



FF1A06 - 23 piezas































FF1A06







45 x 543 x 445 mm 1 FF1A06

BE-8020L, BE-8040		
BE-8150, BE-8255, BE-8256		
BE-8350		
BE-8601		
BE-8610, BE-8620		
BE-8910, BE-8915, BE-8920, BE-8925, BE-8927, BE-8930		
MTB-3-16		
2101G-160IP		
2427 G-200 IP		
2535L		
2628 G-160IP		
2951-180		
5515T-52		
8224 IP		



























FF1A07 - 15 piezas



FF1A07

40 x 543 x 445 mm 1 FF1A07

3734N-3-150, 3734N-5-150, 3734N-6-150		
3735N-4-120		
3740-175		
SQZ150003		
1-100-08-2-2		
1-210-08-2-2		
1-230-08-2-2		
2744		
3625W-35		
3745-150		
481-400		
782-U		
317		

FF1A08 - 168 piezas























































FF1A08























60 x 543 x 445 mm 1 FF1A08

A6800DM-6, A6800DM-7, A6800DM-8, A6800DM-9, A6800DM-10, A6800DM-11, A6800DM-12, A6800DM-13, A6800DM-5.5		
A7402DM-19, A7402DM-10, A7402DM-11, A7402DM-12, A7402DM-13, A7402DM-14, A7402DM-15, A7402DM-16, A7402DM-17, A7402DM-18		
1544		
6700SM-5.5, 6700SM-6, 6700SM-7, 6700SM-8, 6700SM-9, 6700SM-10, 6700SM-11, 6700SM-12, 6700SM-13		
6709M-3, 6709M-4, 6709M-5, 6709M-6, 6709M-8		
6709PH-1, 6709PH-2, 6709PH-3		
6709TORX-T20, 6709TORX-T25, 6709TORX-T27, 6709TORX-T30, 6709TORX-T40, 6709TORX-T8, 6709TORX-T9, 6709TORX-T10, 6709TORX-T15		
6950SL		
6954		
6956		
6958		
6960, 6961, 6962, 6962L		
6966		
6972H		
7400SM-6, 7400SM-7, 7400SM-8, 7400SM-9, 7400SM-10, 7400SM-11, 7400SM-12, 7400SM-13, 7400SM-14, 7400SM-15, 7400SM-16, 7400SM-17, 7400SM-18, 7400SM-19, 7400SM-22		
7407H		
7409M-8, 7409M-10, 7409M-3, 7409M-4, 7409M-5, 7409M-6, 7409M-7		
7409TORX-T25, 7409TORX-T27, 7409TORX-T30, 7409TORX-T40, 7409TORX-T45, 7409TORX-T50		
7750SL		
7754		
7758		
7760, 7761, 7762		
7764		
7765		
7766		
7800SM-18, 7800SM-19, 7800SM-21, 7800SM-22, 7800SM-24, 7800SM-27, 7800SM-30, 7800SM-32, 7800SM-10, 7800SM-11, 7800SM-12, 7800SM-13, 7800SM-14, 7800SM-15, 7800SM-16, 7800SM-17		



7807H

7809M-12, 7809M-14, 7809M-17, 7809M-19, 7809M-5, 7809M-6, 7809M-7, 7809M-8, 7809M-10		
7809TORX-T50, 7809TORX-T55, 7809TORX-T60, 7809TORX-T20, 7809TORX-T25, 7809TORX-T27, 7809TORX-T30, 7809TORX-T40, 7809TORX-T45		
8150SL		
8154-1/2		
8160-1/2, 8162-1/2		
8164-1/2		
8165-1/2		
8166-1/2		
8964		









FF1A09 - 34 piezas



FF1A09

50 x 543 x 445 mm 1 FF1A09

111M-30, 111M-32, 111M-6, 111M-7, 111M-8, 111M-9, 111M-10, 111M-11, 111M-12, 111M-13, 111M-14, 111M-15, 111M-16, 111M-17, 111M-18, 111M-19, 111M-21, 111M-22, 111M-24, 111M-27		
1320RM-10-11, 1320RM-12-13, 1320RM-8-9		
6M-6-7, 6M-8-9, 6M-10-11, 6M-12-13, 6M-14-15, 6M-16-17, 6M-18-19, 6M-20-22, 6M-24-27, 6M-30-32		
9071C		

FF1A10 - 66 piezas



FF1A10





45 x 543 x 445 mm 1 FF1A10

BE-8020L, BE-8030		
BE-8155		
BE-8260		
BE-8350		
BE-8601, BE-8602		
BE-8610, BE-8620		
BE-8630		
BE-8910, BE-8915, BE-8920, BE-8925, BE-8927, BE-8930, BE-8940		
BE-9770		
MTB-3-16		
1150-1/2H/P		
1177-SCRIBE		
2820EF2		
5515T-52		
808050S		
2047-0.8-4		
2047PR-1-2		
59S/31-1		

FF1A1001 - 14 piezas



FF1A1001

45 x 543 x 445 mm 1 FF1A1001

2509		
2535F1		
BE-8040, BE-8210, BE-8230, BE-8252		
BE-8255		
BE-8350		
BE-8628		
BE-8602		
BE-8610L, BE-8620L		
BE-8629, BE-8630		

FF1A1002 - 27 piezas



FF1A1002

40 x 543 x 445 mm 1 FF1A1002

BE-8210, BE-8030, BE-8040		
BE-8350		
BE-8242, BE-8252		
BE-8257, BE-8258		
BE-8880		
BE-8602		
BE-8610, BE-8620		
BE-8630, BE-8640		
BE-8800		
BE-8802		
BE-8810, BE-8820		
BE-9578		

FF1A1003 - 34 piezas



FF1A1003

40 x 543 x 445 mm 1 FF1A1003

BE-8158, BE-8159		
BE-8350		
BE-8870, BE-8880		
BE-8610		
BE-8602		
BE-8630		
BE-8908		
BE-9575		
BE-8909, BE-8910, BE-8915, BE-8920, BE-8925, BE-8927, BE-8930, BE-8940		
BE-9578		

FF1A1004 - 19 piezas



FF1A1004

38 x 543 x 445 mm 1 FF1A1004

900T-050-150, 900T-020-100, 900T-025-100, 900T-030-100, 900T-040-150, 900T-060-200, 900T-080-200, 900T-100-200		
BE-9777B		

FF1A1005 - 66 piezas



FF1A1005

43 x 543 x 445 mm 1 FF1A1005

59S/31-1		
BE-8020, BE-8240		
BE-8250, BE-8255		
BE-8865		
BE-8602		
BE-8611		
BE-9585		
BE-8621		
BE-8630		
BE-8800		
BE-8802		
BE-8811, BE-8821		
BE-8830		
BE-8910, BE-8915, BE-8920, BE-8925		
BE-9678		



FF1A1006 - 29 piezas



FF1A1006

40 x 543 x 445 mm 1 FF1A1006

BE-8030, BE-8040		
BE-8155		
BE-8350		
BE-8602		
BE-8611, BE-8621		
BE-8630		
BE-8906, BE-8907, BE-8908, BE-8909, BE-8910, BE-8915, BE-8920, BE-8925, BE-8930, BE-8940		
BE-9688		
BE-7606, BE-7607		

FF1A1007 - 62 piezas



FF1A1007

44 x 543 x 445 mm 1 FF1A1007

2510	
5468-112	
5471 F-145	
59/S31	
BE-8040	
BE-8158, BE-8159	
BE-8220	
BE-8340	
BE-8601	
BE-8628, BE-8629	
BE-8865	
BE-8906, BE-8907, BE-8908, BE-8909, BE-8910, BE-8915, BE-8920, BE-8925, BE-8930	
BE-9770	
TL 124-SA	

FF1A1008 - 60 piezas



FF1A1008

49 x 543 x 445 mm 1 FF1A1008

BE-8020L		
59S/31-1		
808050		
BE-8040		
BE-8150, BE-8255, BE-8256		
BE-8340		
BE-8601		
BE-8610, BE-8620		
BE-8925, BE-8927, BE-8930, BE-8940, BE-8945		
BE-9678		

FF1A1010 - 54 piezas



FF1A1010

51 x 543 x 445 mm 1 FF1A1010

901T-010-100, 901T-015-150, 901T-020-150, 901T-025-150, 901T-027-150, 901T-030-200, 901T-040-200		
808050		
1419-MD		
7805DM-10		
BE-9678		
7805DM-12, 7805DM-13, 7805DM-17, 7805DM-19		
59S/31-1		

FF1A1011 - 12 piezas

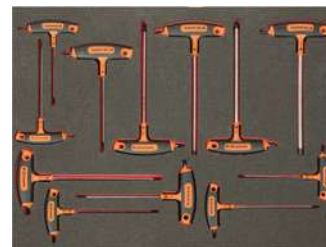

FF1A1011

35 x 543 x 445 mm 1 FF1A1011

903T-2		
903T-1		

FF1A102 - 24 piezas



FF1A102

40 x 543 x 445 mm 1 FF1A102

111M-32, 111M-8, 111M-9, 111M-10, 111M-11, 111M-12, 111M-13, 111M-14, 111M-15, 111M-16, 111M-17, 111M-18, 111M-19, 111M-21, 111M-22, 111M-24, 111M-27		
7224		
2800-180		
2900-180		
2890-180		
2990-180		
2101G-180		
2628 G-180IP		

FF1A104 - 19 piezas



FF1A104

35 x 543 x 445 mm 1 FF1A104

111M-32, 111M-7, 111M-8, 111M-9,
111M-10, 111M-11, 111M-12, 111M-13,
111M-14, 111M-15, 111M-16, 111M-17,
111M-18, 111M-19, 111M-21, 111M-22,
111M-24, 111M-27

59/S54BC



FF1A106 - 93 piezas



FF1A106



55 x 543 x 445 mm



1 FF1A106

FF1A11 - 13 piezas



FF1A11



43 x 543 x 445 mm



1 FF1A11

2101GC-125IP, 2101GC-160IP

21HDGC-200IP

2427 GC-200IP

2430 GC-200 IP

2628 GC-160IP

2928-160, 2928-200, 2928-250

2951-250

2952-165

8224CIP



FF1A110 - 11 piezas



FF1A110



50 x 543 x 445 mm



1 FF1A110

2535L

426TOR9

9572-200

MTB-8-25

SQZ150003

3875-LY3

479-24

481-400

529-20-L

225-PLUS

208



FF1A112 - 22 piezas



FF1A112



35 x 543 x 445 mm



1 FF1A112

S4RM/3T

111M-6, 111M-7, 111M-8, 111M-9,
111M-10, 111M-11, 111M-12, 111M-13,
111M-14, 111M-15, 111M-16, 111M-17,
111M-18, 111M-19, 111M-20, 111M-21,
111M-22, 111M-24, 111M-27

9031



FF1A114 - 18 piezas



FF1A114



42 x 543 x 445 mm



1 FF1A114

8224 IP

2632

3734-2, 3734-3, 3734-4, 3734-5, 3734-6, 3734-8

2800-180

2890-180

2900-180

2990-180

4611-2

479-24

1435/5

1178-SCRIBE

2430 G-160 IP

2101G-180IP



FF1A115 - 9 piezas



FF1A115



35 x 543 x 445 mm



1 FF1A115

1-210-08-1-2

9045-B-250

406T-225

MTB-5-25

K-AP-1

268

5515T-52

319













FF1A117 - 26 piezas



FF1A117

 35 x 543 x 445 mm   1 FF1A117





























B191.040.100		
B190.055.125, B190.065.150		
B192.000.075, B192.001.100, B192.002.125		
111M-32, 111M-6, 111M-7, 111M-8, 111M-9, 111M-10, 111M-11, 111M-12, 111M-13, 111M-14, 111M-15, 111M-16, 111M-17, 111M-18, 111M-19, 111M-21, 111M-22, 111M-24, 111M-27		
8073 IP		

FF1A118 - 14 piezas



FF1A118



 35 x 543 x 445 mm   1 FF1A118





















1-100-08-2-2		
2430 G-160 IP		
2628G-200IP		
2800-180		
2900-180		
2890-180		
2990-180		
5515T		
1-170-08-2-2		
1-210-08-2-2		
1-230-08-2-2		
2535F1		
8224 IP		
2101G-180IP		

FF1A119 - 10 piezas



FF1A119



 47 x 543 x 445 mm   1 FF1A119































3734S/6		
481-300		
KG AU-01		
MTB-5-25-M-E		
137-10		
1150-1/2H/P		
426TOR9		
BLTS10		
375-8		
319		

FF1A12 - 19 piezas



FF1A12

 35 x 543 x 445 mm   1 FF1A12

















FS-8		
1-100-06-1-2, 1-100-06-2-2		
1-160-06-1-2		
1-210-06-1-2		
1-230-06-1-2		
2509		
2535F2		
3625W-35		
3734-3, 3734-5, 3734-8		
3735-4-120		
3740-150		
3745-150		
481-300, 481-500		
8158-1/2		
319		

FF1A121 - 28 piezas



FF1A121

 40 x 543 x 445 mm   1 FF1A121









111M-8, 111M-9, 111M-10, 111M-11, 111M-12, 111M-13, 111M-14, 111M-15, 111M-16, 111M-17, 111M-18, 111M-19, 111M-22		
2470 G-200		
7224		
2953-250		
6M-6-7, 6M-8-9, 6M-10-11, 6M-12-13, 6M-14-15, 6M-16-17, 6M-18-19, 6M-20-22		
2800-180		
2900-180		
2101G-160IP		

FF1A124 - 25 piezas



FF1A124

 45 x 543 x 445 mm   1 FF1A124

B191.040.100		
B190.055.125, B190.065.150		
B192.000.075, B192.001.100, B192.002.125		
111M-10, 111M-11, 111M-12, 111M-13, 111M-14, 111M-15, 111M-16, 111M-17, 111M-18, 111M-19, 111M-21, 111M-22, 111M-24, 111M-27, 111M-32, 111M-6, 111M-7, 111M-8, 111M-9		

FF1A127 - 11 piezas



FF1A127

35 x 543 x 445 mm 1 FF1A127

720031	
3734S/6	
479-16	
3625W-35	
MTG-3-16	
KB18-01	
KSBG18-10DISPEN	
8224 IP	
2101G-160IP	
2628 G-180IP	
2430 G-200 IP	

FF1A128 - 18 piezas



FF1A128

65 x 543 x 445 mm 1 FF1A128

9029, 9031	
111Z-1/4, 111Z-5/16, 111Z-3/8, 111Z-7/16, 111Z-1/2, 111Z-9/16, 111Z-5/8, 111Z-11/16, 111Z-3/4, 111Z-13/16, 111Z-7/8, 111Z-1	
1-473-08-2-2	
361-12	
2633/S4	
S4RM/5T	

FF1A129 - 40 piezas



FF1A129

45 x 543 x 445 mm 1 FF1A129

2171G-180	
2470 G-200	
2477 G-200	
9033, 9035	
1520 G	
808050P	
B191.040.100	
B190.055.125, B190.065.150	
B192.000.075, B192.001.100, B192.002.125	
BE-9777B	
2678 G-200	
59S/31-1	

FF1A13 - 83 piezas



FF1A13

55 x 543 x 445 mm 1 FF1A13

A6700DZ-1/2, A6700DZ-1/4, A6700DZ-11/32, A6700DZ-3/16, A6700DZ-3/8, A6700DZ-5/16, A6700DZ-7/16, A6700DZ-7/32, A6700DZ-9/16, A6700DZ-9/32	
A6710DZ-1/2, A6710DZ-1/4, A6710DZ-11/32, A6710DZ-3/16, A6710DZ-3/8, A6710DZ-5/16, A6710DZ-7/16, A6710DZ-7/32, A6710DZ-9/16, A6710DZ-9/32	
A6800DM-10, A6800DM-4	
A6800DZ-1/2, A6800DZ-1/4, A6800DZ-11/32, A6800DZ-3/16, A6800DZ-3/8, A6800DZ-5/16, A6800DZ-7/16, A6800DZ-7/32, A6800DZ-9/16, A6800DZ-9/32	
A7400DZ-1/2, A7400DZ-1/4, A7400DZ-11/16, A7400DZ-13/16, A7400DZ-17/32, A7400DZ-19/32, A7400DZ-3/4, A7400DZ-3/8, A7400DZ-5/16, A7400DZ-5/8, A7400DZ-7/16, A7400DZ-7/8, A7400DZ-9/16	

A7402DZ-1/2, A7402DZ-1/4, A7402DZ-11/16, A7402DZ-13/16, A7402DZ-19/32, A7402DZ-3/4, A7402DZ-3/8, A7402DZ-5/16, A7402DZ-5/8, A7402DZ-7/16, A7402DZ-7/8, A7402DZ-9/16	
6700SZ-5/32	
6950SL	
6954	
6956	
6958	
6960, 6961, 6962, 6962L	
6966	
6972H	
7407H, 7408H	
7750SL	
7752	
7754	
7758	
7760, 7761, 7762	
7764	
7765	
7766	
8164-1/2	
8165-1/2	

FF1A130 - 53 piezas



FF1A130

45 x 543 x 445 mm 1 FF1A130

7800SM-18, 7800SM-19, 7800SM-21, 7800SM-22, 7800SM-23, 7800SM-24, 7800SM-27, 7800SM-30, 7800SM-32, 7800SM-8, 7800SM-9, 7800SM-10, 7800SM-11, 7800SM-12, 7800SM-13, 7800SM-14, 7800SM-15, 7800SM-16, 7800SM-17	
8150SL	
SBS87S, SBS87	
SBS83-3, SBS83-5, SBS83-10	
SBS85	
SBS86	
SBS88	
SBS89	
7809TORX-T50, 7809TORX-T55, 7809TORX-T60, 7809TORX-T20, 7809TORX-T25, 7809TORX-T27, 7809TORX-T30, 7809TORX-T40	
7809M-14, 7809M-17, 7809M-19, 7809M-5, 7809M-6, 7809M-7, 7809M-8, 7809M-9, 7809M-10, 7809M-12	
7809TORX-T45	
7809M-10-140, 7809M-5-180, 7809M-6-140, 7809M-7-100, 7809M-8-120	



FF1A131 - 25 piezas



FF1A131

40 x 543 x 445 mm 1 FF1A131

SQZ150003	
FS-8	
SQZ150003-SBL	
481-400	
3625N-35	
3734-2, 3734-4, 3734-5, 3734-6, 3734-8, 3734-3	
3735-5-120	
3740-175	
BE-9678	
1547	
319	
208	

FF1A132 - 31 piezas



FF1A132

40 x 543 x 445 mm 1 FF1A132

7400SM-6, 7400SM-7, 7400SM-8, 7400SM-9, 7400SM-10, 7400SM-11, 7400SM-12, 7400SM-13, 7400SM-14, 7400SM-15, 7400SM-16, 7400SM-17, 7400SM-18, 7400SM-19	
7750SL	
SBS705	
SBS755	
SBS723, SBS724	
SBS775	
SBS760, SBS761, SBS762	
1-100-08-1-2	
1-160-08-1-2	
1-170-08-2-2	
1-210-08-1-2	
1-230-08-1-2	
2635	
1150D	
2681	

FF1A133 - 17 piezas



FF1A133

35 x 543 x 445 mm 1 FF1A133

900T-020-100, 900T-025-100, 900T-030-100, 900T-040-150, 900T-050-150, 900T-060-200, 900T-080-200, 900T-100-200	
B194.006.075, B194.007.075, B194.008.075, B194.009.075, B194.010.075, B194.015.100, B194.020.100, B194.025.125, B194.030.150	

FF1A134 - 21 piezas



FF1A134

37 x 543 x 445 mm 1 FF1A134

111M-10, 111M-11, 111M-12, 111M-13, 111M-14, 111M-15, 111M-16, 111M-17, 111M-18, 111M-19, 111M-20, 111M-21, 111M-22, 111M-24, 111M-27, 111M-30, 111M-32, 111M-6, 111M-7, 111M-8, 111M-9	
---	--

FF1A135 - 51 piezas



FF1A135

40 x 543 x 445 mm 1 FF1A135

4040M-8-9, 4040M-10-11, 4040M-12-13, 4040M-14-15	
59S/31-1	
4040M-16-17, 4040M-18-19, 4040M-20-22, 4040M-21-23	
6M-10-11, 6M-12-13, 6M-14-15, 6M-16-17, 6M-18-19, 6M-20-22, 6M-21-23, 6M-24-27, 6M-25-28, 6M-30-32, 6M-6-7, 6M-8-9	

FF1A136 - 39 piezas



FF1A136

40 x 543 x 445 mm 1 FF1A136

2628 G-180	
2430 G-160	
8224	
2101G-160	
6700SM-4.5, 6700SM-5, 6700SM-5.5, 6700SM-6, 6700SM-7, 6700SM-8, 6700SM-9, 6700SM-10, 6700SM-11, 6700SM-12, 6700SM-13, 6700SM-14, 6700SM-4	
6950SL	
SBS67	
SBS64	
SBS69	
SBS65	
SBS63-2, SBS63-4, SBS63-6	
2800-180	
2890-180	
2900-180	
2990-180	
B191.030.075, B191.040.100	
B190.055.100	
B195.050.025	
B190.065.125, B190.080.150	
B195.001.025	
B192.001.100, B192.002.125	
808050	

FF1A137 - 59 piezas



FF1A137

50 x 543 x 445 mm	1	FF1A137

7800SM-18, 7800SM-19, 7800SM-21, 7800SM-22, 7800SM-23, 7800SM-24, 7800SM-27, 7800SM-30, 7800SM-32, 7800SM-8, 7800SM-9, 7800SM-10, 7800SM-11, 7800SM-12, 7800SM-13, 7800SM-14, 7800SM-15, 7800SM-16, 7800SM-17		
8150SL		
SBS87S, SBS87		
SBS83-3, SBS83-5, SBS83-10		
SBS85		
SBS86		
SBS88		
SBS89		
7809TORX-T50, 7809TORX-T55, 7809TORX-T60, 7809TORX-T20, 7809TORX-T25, 7809TORX-T27, 7809TORX-T30, 7809TORX-T40, 7809TORX-T45		
6700SM-4.5, 6700SM-5, 6700SM-5.5, 6700SM-6, 6700SM-7, 6700SM-8, 6700SM-9, 6700SM-10, 6700SM-11, 6700SM-12, 6700SM-13, 6700SM-14, 6700SM-4		
6950SL		
SBS67		
SBS64		
SBS69		
SBS65		
SBS63-2, SBS63-4, SBS63-6		

FF1A138 - 24 piezas



FF1A138

40 x 543 x 445 mm	1	FF1A138

SQZ150003		
FS-8		
SQZ150003-SBL		
481-400		
3625N-35		
3734-2, 3734-3, 3734-4, 3734-5, 3734-6, 3734-8		
3735-5-120		
3740-175		
BE-9678		
319		
208		

FF1A139 - 18 piezas



FF1A139

38 x 543 x 445 mm	1	FF1A139

808050		
900T-020-100, 900T-025-100, 900T-030-100, 900T-040-150, 900T-050-150, 900T-060-200, 900T-080-200, 900T-100-200		
B191.030.075, B191.040.100		
B190.055.100		
B195.050.025		
B190.065.125, B190.080.150		
B195.001.025		
B192.001.100, B192.002.125		

FF1A14 - 43 piezas



FF1A14

46 x 543 x 445 mm	1	FF1A14

111Z-1, 111Z-1/2, 111Z-1/4, 111Z-11/16, 111Z-13/16, 111Z-15/16, 111Z-3/4, 111Z-3/8, 111Z-5/16, 111Z-5/8, 111Z-7/16, 111Z-7/8, 111Z-9/16		
1320RZ-1/2-9/16, 1320RZ-1/4-5/16, 1320RZ-3/8-7/16		
1931Z-1/2, 1931Z-1/4, 1931Z-11/32, 1931Z-3/16, 1931Z-3/8, 1931Z-5/16, 1931Z-5/32, 1931Z-7/16, 1931Z-7/32, 1931Z-9/16, 1931Z-9/32		
1950MZ-3/8		
1952Z-11/32		
6Z-1.1/16-1.1/4, 6Z-1-1.1/8, 6Z-1/2-9/16, 6Z-1/4-5/16, 6Z-15/16-1, 6Z-19/32-11/16, 6Z-25/32-13/16, 6Z-3/8-7/16, 6Z-5/16-11/32, 6Z-5/8-3/4, 6Z-7/8-15/16		
8069 C IP		
9070C		

FF1A141 - 47 piezas



FF1A141

42 x 543 x 445 mm	1	FF1A141

2628 G-180		
2430 G-160		
8224		
2101G-160		
2800-180		
2890-180		
2900-180		
2990-180		
4040M-8-9, 4040M-10-11, 4040M-12-13, 4040M-14-15, 4040M-16-17, 4040M-18-19, 4040M-20-22		
59S/31-1		
4040M-21-23		



FF1A142 - 71 piezas



FF1A142

50 x 543 x 445 mm	1 FF1A142

7800SM-18, 7800SM-19, 7800SM-21, 7800SM-22, 7800SM-23, 7800SM-24, 7800SM-27, 7800SM-30, 7800SM-32, 7800SM-8, 7800SM-9, 7800SM-10, 7800SM-11, 7800SM-12, 7800SM-13, 7800SM-14, 7800SM-15, 7800SM-16, 7800SM-17	
8150SL	
BE-9678	
SBS87S, SBS87	
SBS83-3, SBS83-5, SBS83-10	
SBS85	
SBS86	
SBS88	
SBS89	
1547	
1150D	
59S/31-1	

FF1A143 - 16 piezas



FF1A143

45 x 543 x 445 mm	1 FF1A143

SQZ150003	
FS-8	
SQZ150003-SBL	
MTB-5-25	
481-400	
3625N-35	
3734-2, 3734-3, 3734-4, 3734-5, 3734-6, 3734-8	
3735-5-120	
3740-175	
319	
208	

FF1A145 - 20 piezas



FF1A145

38 x 543 x 445 mm	1 FF1A145

2628 G-180	
2430 G-160	
8224	
2101G-160	
8045LVDE	
808050	
613-3-75	
611-4-100, 611-5.5-100, 611-6.5-150, 611-8-150	
615-1-100, 615-2-125	
611-6.5-25	
615-2-25	
1-100-08-1-2	
1-160-08-1-2	
1-170-08-2-2	
1-210-08-1-2	
1-230-08-1-2	

FF1A146 - 34 piezas



FF1A146

50 x 543 x 445 mm	1 FF1A146

2628 G-180	
2430 G-160	
8224	
2101G-160	
FS-8	
7800SM-18, 7800SM-19, 7800SM-21, 7800SM-22, 7800SM-23, 7800SM-24, 7800SM-27, 7800SM-30, 7800SM-32, 7800SM-8, 7800SM-9, 7800SM-10, 7800SM-11, 7800SM-12, 7800SM-13, 7800SM-14, 7800SM-15, 7800SM-16, 7800SM-17	
8150SL	
SBS87S, SBS87	
SBS83-3, SBS83-5, SBS83-10	
SBS85	
SBS86	
SBS88	
SBS89	

FF1A147 - 16 piezas



FF1A147

40 x 543 x 445 mm	1 FF1A147













2951-250, 2951-180	
3625N-35	
SQZ150003	
SQZ150003-SBL	
B191.030.075, B191.040.100	
B190.055.100	
B195.050.025	
B190.065.125, B190.080.150	
B195.001.025	
B192.001.100, B192.002.125	
319	
208	

FF1A15 - 12 piezas



FF1A15

 40 x 543 x 445 mm   1 FF1A15

















2101GC-125IP, 2101GC-160IP	
2233D-240IP	
2421GC-180IP	
2427 GC-200IP	
2430 GC-200 IP	
2628 GC-160IP	
2650	 
2855, 2855 D	 
2951-180	
8224CIP	 

FF1A16 - 18 piezas



FF1A16

 40 x 543 x 445 mm   1 FF1A16















KE18-01	
1150-1/2H/P	
MTB-3-16	
1177-SCRIBE	
1544	
2509	
2535F2	
2632	
268	
2744	
2820EF2	
3525HB	
5471 F-145	
5515T	
5515T-52	
5516	

FF1A17 - 66 piezas



FF1A17

 50 x 543 x 445 mm   1 FF1A17







BE-8020L	
BE-8150, BE-8155	
BE-8220	
BE-8260	
BE-8350	
BE-8601, BE-8602	
BE-8610, BE-8620	
BE-8630	
BE-9780	
2047-1-5.5	
2047PR-1-2	
706-2	
808050	
59/S28-4	 

FF1A18 - 26 piezas



FF1A18

 44 x 543 x 445 mm   1 FF1A18



1-476-04-3-2	
2633/S4	
3625N-35	
3734S/6	
3736S/6	
481-200, 481-500	
782-U	

FF1A19 - 33 piezas



FF1A19

 50 x 543 x 445 mm   1 FF1A19



111M-30, 111M-32, 111M-6, 111M-7, 111M-8, 111M-9, 111M-10, 111M-11, 111M-12, 111M-13, 111M-14, 111M-15, 111M-16, 111M-17, 111M-18, 111M-19, 111M-20, 111M-21, 111M-22, 111M-24, 111M-27	
6M-6-7, 6M-8-9, 6M-10-11, 6M-12-13, 6M-14-15, 6M-16-17, 6M-18-19, 6M-20-22, 6M-21-23, 6M-24-27, 6M-30-32	
92C	

FF1A20 - 18 piezas



FF1A20

 50 x 543 x 445 mm   1 FF1A20

2M-6-7, 2M-8-9, 2M-10-11, 2M-12-13, 2M-14-15, 2M-16-17, 2M-18-19, 2M-20-22, 2M-21-23, 2M-24-27, 2M-30-32	
4040M-10-11, 4040M-12-13, 4040M-14-15, 4040M-16-17, 4040M-18-19, 4040M-21-23	
2953-250	



FF1A21 - 66 piezas



FF1A21



48 x 543 x 445 mm



1 FF1A21

BE-8257, BE-8255		
BE-8242, BE-8040, BE-8030		
59S/31-1		
BE-8611, BE-8620		
BE-8910, BE-8915, BE-8920		
BE-9575		
BE-8925, BE-8927, BE-8930, BE-8940		
BE-8577		
BE-8355		
BE-8602		
BE-9678		
2446		
7800SM-15		

FF1A22 - 58 piezas



FF1A22



50 x 543 x 445 mm



1 FF1A22

7800SM-18, 7800SM-19, 7800SM-21, 7800SM-22, 7800SM-23, 7800SM-24, 7800SM-27, 7800SM-30, 7800SM-32, 7800SM-10, 7800SM-12, 7800SM-13, 7800SM-14, 7800SM-16, 7800SM-17		
7805SM-27, 7805SM-13, 7805SM-30, 7805SM-16, 7805SM-32, 7805SM-17, 7805SM-18, 7805SM-19, 7805SM-21, 7805SM-22, 7805SM-24		
7809M-12, 7809M-14, 7809M-8, 7809M- 5, 7809M-10, 7809M-6		

8158-1/2		
8154-1/2		
8159-1/2, 8160-1/2		
8166-1/2		
8150SL		
6700SM-4.5, 6700SM-5, 6700SM-5.5, 6700SM-6, 6700SM-7, 6700SM-8, 6700SM-9, 6700SM-10, 6700SM-11, 6700SM-12, 6700SM-13, 6700SM-4		
6958		
6954		
6960, 6962		
6966		
6950SL		
4532-A		

FF1A23 - 21 piezas



FF1A23



40 x 543 x 445 mm



1 FF1A23

3735-4-120		
3734-2, 3734-3, 3734-4, 3734-5, 3734- 6, 3734-8		
2630GC-180IP		
2430 GC-200 IP		
2427 GC-200IP		
2900-180		
2890-180		
2990-180		
2800-180		
7224		
2101GC-160IP		
479-16		
3625N-35		
1547		
MTB-3-16		
SC127		

FF1A2301 - 26 piezas



FF1A2301



70 x 543 x 445 mm



1 FF1A2301

8900DM-19, 8900DM-26, 8900DM-25, 8900DM-24, 8900DM-23, 8900DM-29, 8900DM-28, 8900DM-27, 8900DM-22, 8900DM-34, 8900DM-33, 8900DM-32, 8900DM-30, 8900DM-36, 8900DM-41, 8900DM-46, 8900DM-55, 8900DM-50, 8900DM-60		
8954		
8954A		
8958A		
8961		
8965		
8966		
8952N/B		

FF1A24 - 19 piezas



FF1A24



45 x 543 x 445 mm

















1 FF1A24

FF1A25 - 50 piezas



FF1A25

 50 x 543 x 445 mm   1 FF1A25

7800SM-18, 7800SM-19, 7800SM-21, 7800SM-22, 7800SM-23, 7800SM-24, 7800SM-27, 7800SM-30, 7800SM-32, 7800SM-10, 7800SM-12, 7800SM-13, 7800SM-14, 7800SM-15, 7800SM-16, 7800SM-17	 
7805SM-27, 7805SM-13, 7805SM-30, 7805SM-32, 7805SM-16, 7805SM-17, 7805SM-18, 7805SM-19, 7805SM-21, 7805SM-22, 7805SM-24	 
8154-1/2	
8159-1/2, 8160-1/2	
8166-1/2	
8150SL	
6700SM-4.5, 6700SM-5, 6700SM-5.5, 6700SM-6, 6700SM-7, 6700SM-8, 6700SM-9, 6700SM-10, 6700SM-11, 6700SM-12, 6700SM-13, 6700SM-4	 
6954	
6960, 6962	
6966	
6950SL	
2953-250	

FF1A2501 - 83 piezas



FF1A2501

 50 x 543 x 445 mm   1 FF1A2501



























6700SM-8, 6700SM-7, 6700SM-6, 6700SM-5.5, 6700SM-12, 6700SM-11, 6700SM-10, 6700SM-9, 6700SM-13, 6700SM-5, 6700SM-4	 
6700TORX-E10, 6700TORX-E8	 
6709M-5, 6709M-4, 6709M-3, 6709M-8, 6709M-6	 
6709TORX-T40, 6709TORX-T30, 6709TORX-T27, 6709TORX-T8, 6709TORX-T25, 6709TORX-T20, 6709TORX-T15, 6709TORX-T10	 
6950SL	
6954	
6956	
6962	
6966	
7400SM-8, 7400SM-12, 7400SM-11, 7400SM-10, 7400SM-9, 7400SM-22, 7400SM-21, 7400SM-16, 7400SM-15, 7400SM-14, 7400SM-13, 7400SM-20, 7400SM-19, 7400SM-18, 7400SM-17	 
7400TORX-E10, 7400TORX-E8, 7400TORX-E14, 7400TORX-E12	 
7750SL	
7754	
7762	
7764	
7765	
7766	
7768	
7800SM-17, 7800SM-13, 7800SM-12, 7800SM-19, 7800SM-18, 7800SM-27, 7800SM-20, 7800SM-32, 7800SM-30	 
7809M-10	 
7800SM-21	 
7809M-12	 
7800SM-22	 
7809TORX-T40, 7809TORX-T55, 7809TORX-T25, 7809TORX-T50, 7809TORX-T20	 
7800SM-24	 
8150SL	
8154-1/2	
8162-1/2	
8164-1/2	
8165-1/2	
8166-1/2	
8964	

FF1A2503 - 101 piezas



FF1A2503

 55 x 543 x 445 mm   1 FF1A2503

6700SM-4.5, 6700SM-5, 6700SM-5.5, 6700SM-6, 6700SM-7, 6700SM-8, 6700SM-9, 6700SM-10, 6700SM-11, 6700SM-12, 6700SM-13, 6700SM-14, 6700SM-4	 
7800SM-18, 7800SM-19, 7800SM-21, 7800SM-22, 7800SM-23, 7800SM-24, 7800SM-26	 
BE-9678	 
7800SM-27, 7800SM-28, 7800SM-30, 7800SM-32, 7800SM-10, 7800SM-11, 7800SM-12, 7800SM-13, 7800SM-14, 7800SM-15, 7800SM-16, 7800SM-17, 7800SM-8, 7800SM-9	 
7809M-10	 
59S/31-1	 
7809M-10-140	
7809M-12, 7809M-14, 7809M-17, 7809M-19, 7809M-5, 7809M-7, 7809M-8, 7809M-9, 7809M-6	 
7809M-5-180, 7809M-6-140, 7809M-7-100, 7809M-8-120	
808050	
8154-1/2	
8155-1/2	
8160-1/2, 8162-1/2	
8166-1/2	
6950	
6954	
6956	
6960, 6962	
6966	



FF1A26 - 27 piezas



FF1A26

50 x 543 x 445 mm 1 FF1A26

- 111M-30, 111M-32, 111M-6, 111M-7, 111M-8, 111M-9, 111M-10, 111M-11, 111M-12, 111M-13, 111M-14, 111M-15, 111M-16, 111M-17, 111M-18, 111M-19, 111M-20, 111M-21, 111M-22, 111M-24, 111M-27
- 2630GC-180IP
- 2430 GC-200 IP
- 7224
- 2953-250
- 2101GC-160IP
- SC127

FF1A27 - 65 piezas



FF1A27

45 x 543 x 445 mm 1 FF1A27

- BE-8257, BE-8255
- BE-8242, BE-8040, BE-8030
- BE-8611
- 59S/31-1
- BE-8620
- BE-8910, BE-8915
- BE-9575
- BE-8920, BE-8925, BE-8927, BE-8930, BE-8940
- BE-8577
- BE-8355
- BE-9678
- BE-8602

FF1A28 - 48 piezas



FF1A28

50 x 543 x 445 mm 1 FF1A28

- 7800SM-18, 7800SM-19, 7800SM-21, 7800SM-22, 7800SM-23, 7800SM-24, 7800SM-27, 7800SM-30, 7800SM-32, 7800SM-10, 7800SM-12, 7800SM-13, 7800SM-14, 7800SM-15, 7800SM-16, 7800SM-17
- 8154-1/2
- 8159-1/2, 8160-1/2
- 8166-1/2
- 8150SL
- 6700SM-4.5, 6700SM-5, 6700SM-5.5, 6700SM-6, 6700SM-7, 6700SM-8, 6700SM-9, 6700SM-10, 6700SM-11, 6700SM-12, 6700SM-13, 6700SM-4
- 6954
- 6960, 6962
- 6966
- 6950SL
- 3735-4-120
- 3734-2, 3734-3, 3734-4, 3734-5, 3734-6, 3734-8
- 479-16
- 3625N-35
- MTB-3-16

FF1A3001 - 21 piezas



FF1A3001

40 x 543 x 445 mm 1 FF1A3001

- 111M-10, 111M-11, 111M-12, 111M-13, 111M-14, 111M-15, 111M-16, 111M-17, 111M-18, 111M-19, 111M-20, 111M-21, 111M-22, 111M-24, 111M-27, 111M-30, 111M-32, 111M-6, 111M-7, 111M-8, 111M-9

FF1A3002 - 7 piezas



FF1A3002

35 x 543 x 445 mm 1 FF1A3002

- 1RM-19, 1RM-21, 1RM-22, 1RM-24, 1RM-27, 1RM-30, 1RM-32

FF1A3003 - 28 piezas



FF1A3003

40 x 543 x 445 mm 1 FF1A3003

- 1952M-27, 1952M-21, 1952M-20, 1952M-19, 1952M-18, 1952M-24, 1952M-22, 1952M-13, 1952M-12, 1952M-11, 1952M-10, 1952M-17, 1952M-16, 1952M-15, 1952M-14, 1952M-9, 1952M-8, 1952M-7, 1952M-6





- BE-9778

FF1A3004 - 30 piezas



FF1A3004

 48 x 543 x 445 mm   1 FF1A3004





- 111M-24, 111M-22, 111M-17, 111M-16, 111M-15, 111M-14, 111M-21, 111M-20, 111M-19, 111M-18, 111M-9, 111M-8, 111M-7, 111M-6, 111M-13, 111M-12, 111M-11, 111M-10  
- 1RM-10, 1RM-11, 1RM-12, 1RM-13, 1RM-14, 1RM-15, 1RM-16, 1RM-17, 1RM-18, 1RM-19, 1RM-8, 1RM-9  

FF1A3005 - 28 piezas



FF1A3005



 38 x 543 x 445 mm   1 FF1A3005













- 1952M-19, 1952M-18, 1952M-22, 1952M-13, 1952M-12, 1952M-11, 1952M-10, 1952M-17, 1952M-16, 1952M-15, 1952M-14, 1952M-9, 1952M-8, 1952M-7, 1952M-6  
- 1RM-10, 1RM-11, 1RM-12, 1RM-13, 1RM-14, 1RM-17, 1RM-19, 1RM-22, 1RM-24, 1RM-6, 1RM-7, 1RM-8, 1RM-9  

FF1A35 - 24 piezas



FF1A35



 42 x 543 x 445 mm   1 FF1A35











- 317 
- 1-100-08-1-2 
- 1-210-08-1-2 
- 1-230-08-1-2 
- MTB-3-16 
- 3625W-35 
- 481-300 
- 782-U 
- BE-9770 
- KG09-01 
- KSBG09-10P 
- 4040M-10-11, 4040M-12-13, 4040M-14-15, 4040M-16-17, 4040M-8-9  

FF1A36 - 89 piezas



FF1A36

 50 x 543 x 445 mm   1 FF1A36









- BE-8576  
- 4040M-8-9, 4040M-10-11, 4040M-12-13, 4040M-14-15, 4040M-16-17  
- 808050S 
- 808050 
- 6972H 
- K6650-1/4-1P 
- 6950SL 
- 59S/31-1  

FF1A37 - 46 piezas



FF1A37

 35 x 543 x 445 mm   1 FF1A37



- 111M-6, 111M-7, 111M-8, 111M-9, 111M-10, 111M-11, 111M-12, 111M-13, 111M-14, 111M-15, 111M-16, 111M-17, 111M-18, 111M-19, 111M-21, 111M-22, 111M-24  
- 8071 IP 
- 2101G-160 
- 2430 G-160 
- 8224  
- 8150SL 

FF1A39 - 54 piezas



FF1A39

 45 x 543 x 445 mm   1 FF1A39

- S410 
- S1612L 
- 8071 IP 



FF1A40 - 54 piezas



FF1A40

45 x 543 x 445 mm	1 FF1A40

BE-8020, BE-8040	
BE-8150, BE-8155	
BE-8611, BE-8621	
BE-8811, BE-8821	
BE-8910, BE-8915, BE-8920, BE-8925, BE-8930	
904T-060-150	
BE-9770	
59S/31-1	

FF1A4001 - 12 piezas



FF1A4001

38 x 543 x 445 mm	1 FF1A4001

1520 D	
2101G-160IP	
21HDG-200IP	
2223 G-150	
2421 G-140IP, 2421 G-180 IP	
2427 G-200 IP	
2628 G-180IP	
2681	
2951-140, 2951-300	
8224 IP	

FF1A4002 - 11 piezas



FF1A4002

42 x 543 x 445 mm	1 FF1A4002

2101G-160IP	
2430 G-200 IP	
2465D-200	
2510	
2628 G-160IP	
2744	
2951-140	
2952-165	
1520 G	
527 D-160	
7224	

FF1A4003 - 12 piezas



FF1A4003

35 x 543 x 445 mm	1 FF1A4003

2800-150, 2800-180, 2800-225	
2890-140, 2890-180, 2890-210	
2900-150, 2900-180, 2900-215	
2990-140, 2990-180, 2990-200	

FF1A41- 9 piezas



FF1A41

42 x 543 x 445 mm	1 FF1A41

2171G-160	
2470 G-160	
2971G-250	
MTB-3-16	
WR2-12	
3625W-35	
481-300	
218	
306	

FF1A49 - 50 piezas



FF1A49

50 x 543 x 445 mm	1 FF1A49

808050P	
808050S	
6972H	
038.055.100, 038.065.125, 038.080.150	
039.001.100	
59S/31-1	
039.002.125	
BE-8040	
BE-8150	
BE-8010S, BE-8230S	
BE-8155	
9045-B-250	
1150D	
426TOR9	
1179-FLX	
1178-SCRIBE	
MTS-5-25	

FF1A50 - 13 piezas



FF1A50

45 x 543 x 445 mm	1	FF1A50

8223 IP, 8224 IP, 8225 IP		
1420		
2430 G-160 IP		
2427 G-160 IP		
8069		
9070		
9031		
2101G-160IP		
21HDG-180IP		

FF1A5001 - 27 piezas



FF1A5001

40 x 543 x 445 mm	1	FF1A5001

2430 G-200 IP	
2101G-160IP	
2628 G-180IP	
2951-180	
7224	
BE-8150, BE-8155	
BE-8355	
BE-8256	
BE-8611	
BE-8602	
BE-8620	
BE-8910, BE-8915, BE-8920, BE-8925, BE-8930, BE-8940	
BE-9770	

FF1A5002 - 27 piezas



FF1A5002

50 x 543 x 445 mm	1	FF1A5002

111M-30, 111M-32, 111M-6, 111M-7, 111M-8, 111M-9, 111M-10, 111M-11, 111M-12, 111M-13, 111M-14, 111M-15, 111M-16, 111M-17, 111M-18, 111M-19, 111M-20, 111M-21, 111M-22, 111M-24, 111M-27		
3734S/6		

FF1A5003 - 91 piezas



FF1A5003

45 x 543 x 445 mm	1	FF1A5003

111M-13, 111M-12, 111M-10, 111M-8, 111M-19, 111M-17, 111M-15		
6700SM-5.5, 6700SM-5, 6700SM-14, 6700SM-13, 6700SM-12, 6700SM-11, 6700SM-10, 6700SM-9, 6700SM-8, 6700SM-7, 6700SM-6		
6700TORX-E5, 6700TORX-E4, 6700TORX-E10, 6700TORX-E8, 6700TORX-E7, 6700TORX-E6		
6709TORX-T27, 6709TORX-T25, 6709TORX-T20, 6709TORX-T15, 6709TORX-T10, 6709TORX-T9, 6709TORX-T8, 6709TORX-T40, 6709TORX-T30		
6950		
6961, 6962		
6966		
7400SM-13, 7400SM-12, 7400SM-11, 7400SM-10, 7400SM-9, 7400SM-8, 7400SM-21, 7400SM-19, 7400SM-18, 7400SM-17, 7400SM-16, 7400SM-15, 7400SM-14, 7400SM-22		

7400TORX-E18, 7400TORX-E16, 7400TORX-E14, 7400TORX-E12, 7400TORX-E11, 7400TORX-E10, 7400TORX-E8		
7409TORX-T30, 7409TORX-T27, 7409TORX-T25, 7409TORX-T50, 7409TORX-T45, 7409TORX-T40		
7750		
7760, 7761, 7762		
7764		
7765		
7766		
8158-1/2		
A6800DM-8, A6800DM-7, A6800DM-6, A6800DM-14, A6800DM-13, A6800DM-12, A6800DM-11, A6800DM-10, A6800DM-9		
A7402DM-10, A7402DM-11, A7402DM-12, A7402DM-13, A7402DM-14, A7402DM-15, A7402DM-16, A7402DM-17, A7402DM-18, A7402DM-19		

FF1A5004 - 37 piezas



FF1A5004

55 x 543 x 445 mm	1	FF1A5004

1RM-19, 1RM-13, 1RM-12, 1RM-11, 1RM-10, 1RM-9, 1RM-8, 1RM-27, 1RM-7, 1RM-24, 1RM-6, 1RM-22, 1RM-17		
6700SM-13, 6700SM-12, 6700SM-11, 6700SM-10, 6700SM-9, 6700SM-8, 6700SM-7, 6700SM-6		
6950		
6960		
6966		
7800SM-19, 7800SM-17, 7800SM-32, 7800SM-30, 7800SM-13, 7800SM-27, 7800SM-24, 7800SM-22		
8155-1/2		
8160-1/2		
8166-1/2		
SBS64		
SBS86		

































FF1A5005 - 83 piezas



FF1A5005

 50 x 543 x 445 mm  1 FF1A5005













111M-17, 111M-15, 111M-13, 111M-19, 111M-8		
6700SM-8, 6700SM-7, 6700SM-6, 6700SM-12, 6700SM-11, 6700SM-10, 6700SM-9, 6700SM-14, 6700SM-13, 6700SM-5, 6700SM-4		
6709M-5, 6709M-4, 6709M-8, 6709M-6		
6950SL		
6960-W		
6962		
6962-W		
6968		
7400SM-8, 7400SM-7, 7400SM-6, 7400SM-12, 7400SM-11, 7400SM-10, 7400SM-9, 7400SM-16, 7400SM-15, 7400SM-14, 7400SM-13, 7400SM-18, 7400SM-17		
7750SL		
7760-W		
7761		
7768		
7800SM-11, 7800SM-10, 7800SM-15, 7800SM-14, 7800SM-13, 7800SM-12, 7800SM-19, 7800SM-18, 7800SM-17, 7800SM-16, 7800SM-22, 7800SM-21, 7800SM-27, 7800SM-24, 7800SM-32, 7800SM-30, 7800SM-8, 7800SM-9		
7809M-17, 7809M-14, 7809M-12, 7809M-10, 7809M-5, 7809M-6, 7809M-7, 7809M-8		
7809TORX-T40, 7809TORX-T30, 7809TORX-T25, 7809TORX-T20, 7809TORX-T45		
8150SL		
8160-1/2, 8162-1/2		
8166-1/2		
A6709M-6, A6709M-5, A6709M-4, A6709M-3, A6709M-2.5		
K6650-1/4-1P		
6709M-3		

FF1A5006 - 27 piezas



FF1A5006

 54 x 543 x 445 mm  1 FF1A5006















1-100-08-2-2		
1-210-08-2-2		
1-230-06-2-2		
111M-7, 111M-8, 111M-9, 111M-10, 111M-11, 111M-12, 111M-13, 111M-14, 111M-15, 111M-16, 111M-17, 111M-18, 111M-19, 111M-21, 111M-22		
1320RM-6-7, 1320RM-8-9, 1320RM-10-11, 1320RM-12-13, 1320RM-14-15, 1320RM-16-17, 1320RM-18-19, 1320RM-22-24		
1-230-10-2-2		

FF1A5007 - 60 piezas













FF1A5007

 50 x 543 x 445 mm  1 FF1A5007

K6650-1/4-1P		
3734-2, 3734-3, 3734-4, 3734-5, 3734-6, 3734-8		
481-400		
6700SM-11, 6700SM-12, 6700SM-13, 6700SM-14, 6700SM-10, 6700SM-5, 6700SM-6, 6700SM-7, 6700SM-8, 6700SM-9, 6700SM-4		
6709F-8, 6709F-5.5		
6709M-3, 6709M-4, 6709M-5, 6709M-6		
6709PH-1, 6709PH-2		
6950SL		
6954		
6960, 6962		
6966		

7800SM-18, 7800SM-19, 7800SM-10, 7800SM-11, 7800SM-12, 7800SM-13, 7800SM-14, 7800SM-15, 7800SM-16, 7800SM-17, 7800SM-21, 7800SM-22, 7800SM-23, 7800SM-24, 7800SM-25, 7800SM-26, 7800SM-27, 7800SM-28, 7800SM-30, 7800SM-32





















8072 IP		
B145.006.100		
8150SL		
8154-1/2		
8160-1/2, 8162-1/2		
8166-1/2		
8224 IP		

FF1A5008 - 24 piezas



FF1A5008

 50 x 543 x 445 mm  1 FF1A5008

1-100-08-2-2		
1-160-08-2-2		
1-170-08-2-2		
1-210-08-2-2		
1-230-08-2-2		
1150D		
1450D-ISO		
1547		
3625N-40		
3734-2, 3734-3, 3734-4, 3734-5, 3734-6, 3734-8		
3735-4-120, 3735-5-150		
3740-125, 3740-150		
38-20		
5515T		
9029, 9031		
MTB-3-16		

FF1A5009 - 17 piezas



FF1A5009

38 x 543 x 445 mm 1 FF1A5009

2101S-160	
2223 S-150	
2250V-170	
2430 S-200	
2628 S-180	
8072V	
BE-8220S, BE-8040S	
BE-8340	
BE-8050S, BE-8255S, BE-8065S	
BE-8601	
BE-8610S, BE-8620S	
BE-8810S, BE-8820S	

FF1A5010 - 22 piezas



FF1A5010

35 x 543 x 445 mm 1 FF1A5010

1-100-08-1-2	
1-160-08-1-2	
1-170-08-2-2	
1-210-08-1-2	
1-230-08-1-2	
2101G-180IP	
2427 G-200 IP	
2430 G-200 IP	
2628 G-180IP	
3733-2, 3733-4, 3733-6	
3734-2, 3734-3, 3734-4, 3734-5, 3734-6, 3734-8	
3735-4-120	
481-300	
8069 IP	
9031	

FF1A5011 - 27 piezas



FF1A5011

44 x 543 x 445 mm 1 FF1A5011

1-476-04-3-2	
1178-SCRIBE	
1547	
2101G-160IP	
2427 G-160 IP	
2430 G-160 IP	
3734-2, 3734-3, 3734-4, 3734-5, 3734-6, 3734-8	
3735-5-120	
481-500	
BE-8020L, BE-8040	
BE-8150, BE-8255, BE-8256	
BE-8610, BE-8620	
MTB-3-16	

FF1A5012 - 13 piezas



FF1A5012

48 x 543 x 445 mm 1 FF1A5012

141	
3734-2, 3734-3, 3734-4, 3734-5, 3734-6	
479-08	
481-1000, 481-300	
782-U	
MTS-5-25	
SQZ150003	
319	

FF1A5013 - 41 piezas



FF1A5013

50 x 543 x 445 mm 1 FF1A5013

111M-6, 111M-7, 111M-8, 111M-9, 111M-12, 111M-13, 111M-17, 111M-10, 111M-11, 111M-19, 111M-20, 111M-22, 111M-24, 111M-27, 111M-32, 111M-30	
6700SM-6, 6700SM-7, 6700SM-8, 6700SM-9, 6700SM-10, 6700SM-11, 6700SM-12, 6700SM-13, 6700SM-14	
6950	
6960	
6966	
7800SM-19, 7800SM-17, 7800SM-13, 7800SM-22, 7800SM-27, 7800SM-24, 7800SM-30, 7800SM-32	
8155-1/2	
8160-1/2	
8166-1/2	
SBS64	
SBS86	

FF1A5015 - 17 piezas



FF1A5015

45 x 543 x 445 mm 1 FF1A5015

319	
268	
208	
2509	
2444	
2744	
5515T	
BE-8020L, BE-8040	
BE-8150, BE-8255, BE-8256	
BE-8340	
BE-8601	
BE-8610, BE-8620	
MTB-5-25	



FF1A5017 - 16 piezas



FF1A5017



35 x 543 x 445 mm



1 FF1A5017

3625N-35	
3734-2, 3734-3, 3734-4, 3734-5, 3734-6, 3734-8	
3735-5-120	
3740-175	
481-400	
111M-21, 111M-22, 111M-24, 111M-27, 111M-30, 111M-32	

FF1A5019 - 47 piezas



FF1A5019



52 x 543 x 445 mm



1 FF1A5019

111M-17, 111M-18, 111M-19, 111M-20, 111M-6, 111M-7, 111M-8, 111M-13, 111M-14, 111M-15, 111M-16, 111M-9, 111M-10, 111M-11, 111M-12	
2101G-160IP	
2430 G-160 IP	
2628 G-180IP	
7800DM-12, 7800DM-13, 7800DM-14, 7800DM-15, 7800DM-10, 7800DM-11, 7800DM-20, 7800DM-21, 7800DM-22, 7800DM-23, 7800DM-16, 7800DM-17, 7800DM-18, 7800DM-19, 7800DM-28, 7800DM-30, 7800DM-32, 7800DM-24, 7800DM-25, 7800DM-26, 7800DM-27, 7800DM-8, 7800DM-9	
8154-1/2	
8155-1/2	
8160-1/2, 8162-1/2	
8166-1/2	
8224 IP	

FF1A5021 - 17 piezas



FF1A5021



45 x 543 x 445 mm



1 FF1A5021

BE-8020L, BE-8040	
BE-8150, BE-8255, BE-8256	
BE-8340	
BE-8601	
BE-8610, BE-8620	
319	
MTB-5-25	
2444	
268	
5515T	
2509	
2744	
208	

FF1A5022 - 26 piezas



FF1A5022



50 x 543 x 445 mm



1 FF1A5022

6700SM-4.5, 6700SM-5, 6700SM-5.5, 6700SM-6, 6700SM-7, 6700SM-8, 6700SM-9, 6700SM-10, 6700SM-11, 6700SM-12, 6700SM-13, 6700SM-14, 6700SM-4	
6950	
6954	
6956	
6960, 6962	
6966	
8070	
9031	
9072 P	
141	
2101G-160IP	
2430 G-160 IP	
2628 G-180IP	
8224 IP	

FF1A5023 - 16 piezas



FF1A5023



45 x 543 x 445 mm



1 FF1A5023

208	
2444	
2509	
268	
2744	
319	
5515T	
BE-8020L, BE-8040	
BE-8150, BE-8255, BE-8256	
BE-8340	
BE-8601	
BE-8610, BE-8620	

FF1A5024 - 28 piezas



FF1A5024



45 x 543 x 445 mm



1 FF1A5024















111M-12, 111M-13, 111M-6, 111M-7, 111M-8, 111M-9, 111M-10, 111M-11	
1RM-17, 1RM-18, 1RM-19, 1RM-8, 1RM-9, 1RM-10, 1RM-11, 1RM-12, 1RM-13, 1RM-14, 1RM-15, 1RM-16	
2101G-160IP	
2430 G-160 IP	
141	
2628 G-180IP	
9031	
9072 P	
8070	
8224 IP	

FF1A5027 - 36 piezas



FF1A5027

 44 x 543 x 445 mm   1 FF1A5027









2M-20-22, 2M-21-23, 2M-24-27, 2M-25-28, 2M-30-32		
4040M-10-11, 4040M-12-13, 4040M-14-15, 4040M-16-17, 4040M-18-19, 4040M-20-22, 4040M-21-23, 4040M-8-9		
7400SM-6, 7400SM-7, 7400SM-12, 7400SM-13, 7400SM-14, 7400SM-15, 7400SM-8, 7400SM-9, 7400SM-10, 7400SM-11, 7400SM-20, 7400SM-21, 7400SM-22, 7400SM-16, 7400SM-17, 7400SM-18, 7400SM-19		
7754		
7755-3/8		
7760, 7761, 7762		
7766		

FF1A5028 - 33 piezas



FF1A5028



 45 x 543 x 445 mm   1 FF1A5028









111M-6, 111M-7, 111M-8, 111M-9, 111M-10, 111M-11, 111M-14, 111M-15, 111M-16, 111M-17, 111M-18, 111M-19, 111M-20, 111M-12, 111M-13		
1419-MD		
BE-8906, BE-8907, BE-8908, BE-8909, BE-8910, BE-8915, BE-8920, BE-8925, BE-8927, BE-8930, BE-8940, BE-8945		
7805DM-10, 7805DM-12, 7805DM-13, 7805DM-17, 7805DM-19		

FF1A5029 - 29 piezas



FF1A5029



 40 x 543 x 445 mm   1 FF1A5029











2628 G-180IP	
2101G-160IP	
2430 G-160 IP	
8224 IP	
BBR201P6	
BE5103	
2M-10-11, 2M-12-13, 2M-14-15, 2M-16-17, 2M-18-19, 2M-6-7, 2M-8-9	
7809TORX-T25, 7809TORX-T30, 7809TORX-T40, 7809TORX-T45, 7809TORX-T50, 7809TORX-T55	

FF1A5030 - 45 piezas



FF1A5030

 52 x 543 x 445 mm   1 FF1A5030











111M-17, 111M-18, 111M-19, 111M-20, 111M-6, 111M-7, 111M-8, 111M-13, 111M-14, 111M-15, 111M-16, 111M-9, 111M-10, 111M-11, 111M-12		
3625N-35		
2951-180, 2951-250		
7800DM-12, 7800DM-13, 7800DM-14, 7800DM-15, 7800DM-8, 7800DM-9, 7800DM-10, 7800DM-11, 7800DM-20, 7800DM-21, 7800DM-22, 7800DM-23, 7800DM-16, 7800DM-17, 7800DM-18, 7800DM-19, 7800DM-28, 7800DM-30, 7800DM-32, 7800DM-24, 7800DM-26, 7800DM-27		
8154-1/2		
8155-1/2		
8160-1/2, 8162-1/2		
8166-1/2		

FF1A5031 - 62 piezas



FF1A5031

 48 x 543 x 445 mm   1 FF1A5031

1419-MD	
7809M-10	
BE-9678	
7809M-10-140	
7809M-12, 7809M-14, 7809M-17, 7809M-19	
59S/31-1	
7809M-7, 7809M-8, 7809M-5, 7809M-9, 7809M-6	
7809M-5-180, 7809M-6-140, 7809M-7-100, 7809M-8-120	
808050	
7805DM-10, 7805DM-12, 7805DM-13, 7805DM-17, 7805DM-19	



FF1A5032 - 76 piezas



FF1A5032

55 x 543 x 445 mm	1 FF1A5032

6700SM-10, 6700SM-11, 6700SM-8, 6700SM-9, 6700SM-14, 6700SM-12, 6700SM-13, 6700SM-4, 6700SM-6, 6700SM-7, 6700SM-5, 6700SM-4.5, 6700SM-5.5	
6950	
6954	
6956	
6960, 6962	
6966	
7400SM-6, 7400SM-7, 7400SM-10, 7400SM-11, 7400SM-8, 7400SM-9, 7400SM-14, 7400SM-15, 7400SM-12, 7400SM-13, 7400SM-18, 7400SM-19, 7400SM-16, 7400SM-17, 7400SM-22, 7400SM-20, 7400SM-21	
7754	
7755-3/8	
7760, 7761, 7762	
7766	
7800DM-11, 7800DM-14, 7800DM-15, 7800DM-12, 7800DM-13, 7800DM-18, 7800DM-19, 7800DM-16, 7800DM-17, 7800DM-22, 7800DM-23, 7800DM-20, 7800DM-21, 7800DM-26, 7800DM-27, 7800DM-24, 7800DM-30, 7800DM-32, 7800DM-28, 7800DM-8, 7800DM-9	
8154-1/2	
8155-1/2	
8160-1/2, 8162-1/2	
8166-1/2	
111M-19, 111M-17, 111M-18, 111M-15, 111M-16, 111M-14, 111M-20	
7800DM-10	

FF1A5036 - 6 piezas



FF1A5036

38 x 543 x 445 mm	1 FF1A5036

BE255	
BE258	
BE250	
BE256P3	

FF1A5037 - 12 piezas



FF1A5037

75 x 543 x 445 mm	1 FF1A5037

BPC813	
BP814A	
BP922	
BP824	
BP110	
BP118	

FF1A5038 - 50 piezas



FF1A5038

45 x 543 x 445 mm	1 FF1A5038

BBR300P50	
-----------	--

FF1A51 - 23 piezas



FF1A51

40 x 543 x 445 mm	1 FF1A51

1-100-08-1-2		
1-210-08-1-2		
1-230-08-1-2		
4-144-08-2-2		
1-170-08-1-2		
3735-4-120		
3733-4, 3733-2, 3733-6		
3734-2, 3734-3, 3734-4, 3734-5, 3734-6, 3734-8		
2800-180, 2800-150		
2890-140, 2890-180		
2900-150, 2900-180		
2990-140, 2990-180		

FF1A53 - 36 piezas



FF1A53

45 x 543 x 445 mm	1 FF1A53



































BE-8800, BE-8811, BE-8821		
BE-8830		
BE-8600, BE-8611, BE-8621		
BE-8630		
BE-8910, BE-8915, BE-8920, BE-8925		
BE-9770		
BE-9780		
3625S-44		
2800-225		
2890-210		

FF1A55 - 75 piezas



FF1A55

 40 x 543 x 445 mm  1 FF1A55









A6700DZ-1/2, A6700DZ-1/4, A6700DZ-11/32, A6700DZ-3/16, A6700DZ-3/8, A6700DZ-5/16, A6700DZ-7/16, A6700DZ-7/32, A6700DZ-9/16, A6700DZ-9/32		
BE-9775		
SBS61		
SBS63-2, SBS63-6, SBS63-4		
SBS64		
SBS65		
SBS67		
SBS81		
SBS83-10, SBS83-5		
SBS85		
SBS86		
59/S31		
6956		
6972H		
7800DZ-1, 7800DZ-1/2, 7800DZ-11/16, 7800DZ-13/16, 7800DZ-15/16, 7800DZ-19/32, 7800DZ-3/4, 7800DZ-3/8, 7800DZ-5/8, 7800DZ-7/8, 7800DZ-9/16		
808050		
7800DZ-7/16		

FF1A56 - 28 piezas



FF1A56



 63 x 543 x 445 mm  1 FF1A56



111Z-1, 111Z-1/2, 111Z-1/4, 111Z-11/16, 111Z-13/16, 111Z-15/16, 111Z-3/4, 111Z-3/8, 111Z-5/16, 111Z-5/8, 111Z-7/16, 111Z-7/8, 111Z-9/16		
1320RZ-1/2-9/16, 1320RZ-1/4-5/16, 1320RZ-3/8-7/16		
6Z-1.1/16-1.1/4, 6Z-1-1.1/8, 6Z-1/2-9/16, 6Z-1/4-5/16, 6Z-15/16-1, 6Z-19/32-11/16, 6Z-25/32-13/16, 6Z-5/16-11/32, 6Z-5/8-3/4, 6Z-7/8-15/16		
9031		

FF1A59 - 105 piezas



FF1A59



 35 x 543 x 445 mm  1 FF1A59







S560		
BE5049		

FF1A65 - 28 piezas



FF1A65

 50 x 543 x 445 mm  1 FF1A65































111M-19, 111M-17, 111M-18, 111M-24, 111M-21, 111M-22, 111M-7, 111M-8, 111M-6, 111M-11, 111M-12, 111M-9, 111M-10, 111M-15, 111M-16, 111M-13, 111M-14, 111M-20		
1RM-8, 1RM-9, 1RM-12, 1RM-13, 1RM-10, 1RM-11, 1RM-17, 1RM-14, 1RM-19		
319		

FF1A66 - 51 piezas



FF1A66

 50 x 543 x 445 mm  1 FF1A66























038.055.100, 038.065.125, 038.080.150		
039.001.100, 039.002.125		
1178-SCRIBE		
426TOR9		
6972H		
9045-B-250		
BE-8010S		
BE-8040		
BE-8150, BE-8155		
BE-8230S		
BE-8800, BE-8811, BE-8821		
BE-8830		
MTB-5-25		
SQZ150003		
59S/31-1		

FF1A67 - 28 piezas



FF1A67

 39 x 543 x 445 mm  1 FF1A67

9031		
2101G-160IP		
21HDG-180IP		
2427 G-160 IP		
2430 G-160 IP		
8224 IP		
BE-8600, BE-8611, BE-8621		
BE-8630		
BE-8910, BE-8915, BE-8920		
7865		
BE-8925		



FF1A68 - 30 piezas



FF1A68

37 x 543 x 445 mm	1 FF1A68

1-100-08-1-2	
1-170-08-1-2	
1-210-08-1-2	
1-230-08-1-2	
2800-180	
2890-180	
2900-180	
2990-180	
3733-4, 3733-2, 3733-6	
3734-8, 3734-5, 3734-6, 3734-3, 3734-4, 3734-2	
3735-4-120	
4-144-08-2-2	
481-400	
BE-9770	

FF1A70 - 105 piezas



FF1A70

42 x 543 x 445 mm	1 FF1A70

BE5049	
S560	

FF1A71 - 46 piezas



FF1A71

41 x 543 x 445 mm	1 FF1A71

59/S31	
901T-010-100, 901T-015-150, 901T-020-150, 901T-027-150, 901T-030-200, 901T-040-200, 901T-025-150, 901T-045-200, 901T-050-200	
B190.055.125	
B191.030.075, B191.040.100	
B192.001.100	
B705.1/4.125	
B192.002.125	

FF1A72 - 18 piezas



FF1A72

38 x 543 x 445 mm	1 FF1A72

2101GC-160IP	
2430 GC-200 IP	
2630GC-180IP	
2800-180	
2890-180	
2900-180	
2953-200	
2990-180	
3640-200-C	
3734N-10-150, 3734N-2-150, 3734N-3-150, 3734N-4-150, 3734N-5-150, 3734N-6-150, 3734N-8-150	
479-16	
3625W-35	

BANCOS DE TRABAJO

Banco de trabajo de 150cm con encimera de acero y cajonera lateral



BL	RD
BK	RD

1495KCWB15TS

1030 x 750 x 1500 mm	1 1495K6CBKWB15TS
1030 x 750 x 1500 mm	1 1495K6CBLWB15TS
1030 x 750 x 1500 mm	1 1495K6CRDWB15TS
1030 x 750 x 1500 mm	1 1495K6CWB15TS
1030 x 750 x 1500 mm	1 1495K7CBKWB15TS
1030 x 750 x 1500 mm	1 1495K7CBLWB15TS
1030 x 750 x 1500 mm	1 1495K7CRDWB15TS
1030 x 750 x 1500 mm	1 1495K7CWB15TS
1030 x 750 x 1500 mm	1 1495K8CBKWB15TS
1030 x 750 x 1500 mm	1 1495K8CBLWB15TS
1030 x 750 x 1500 mm	1 1495K8CRDWB15TS
1030 x 750 x 1500 mm	1 1495K8CWB15TS

Banco de trabajo de 180cm con encimera de acero y cajonera lateral



1495KCWB18TS

1030 x 750 x 1800 mm	1 1495K6CBKWB18TS
1030 x 750 x 1800 mm	1 1495K6CBLWB18TS
1030 x 750 x 1800 mm	1 1495K6CRDWB18TS
1030 x 750 x 1800 mm	1 1495K6CWB18TS
1030 x 750 x 1800 mm	1 1495K7CBKWB18TS
1030 x 750 x 1800 mm	1 1495K7CBLWB18TS
1030 x 750 x 1800 mm	1 1495K7CRDWB18TS
1030 x 750 x 1800 mm	1 1495K7CWB18TS
1030 x 750 x 1800 mm	1 1495K8CBKWB18TS
1030 x 750 x 1800 mm	1 1495K8CBLWB18TS
1030 x 750 x 1800 mm	1 1495K8CRDWB18TS
1030 x 750 x 1800 mm	1 1495K8CWB18TS

Banco de trabajo de 150 cm con encimera de DM y cajonera lateral



1495KCWB15TD



1030 x 750 x 1500 mm	1	1495K6CBKWB15TD
1030 x 750 x 1500 mm	1	1495K6CBLWB15TD
1030 x 750 x 1500 mm	1	1495K6CRDWB15TD
1030 x 750 x 1500 mm	1	1495K6CWB15TD
1030 x 750 x 1500 mm	1	1495K7CBKWB15TD
1030 x 750 x 1500 mm	1	1495K7CBLWB15TD
1030 x 750 x 1500 mm	1	1495K7CRDWB15TD
1030 x 750 x 1500 mm	1	1495K7CWB15TD
1030 x 750 x 1500 mm	1	1495K8CBKWB15TD
1030 x 750 x 1500 mm	1	1495K8CBLWB15TD
1030 x 750 x 1500 mm	1	1495K8CRDWB15TD
1030 x 750 x 1500 mm	1	1495K8CWB15TD

Banco de trabajo de 150 cm con encimera de madera y cajonera lateral



1495KCWB15TW



1030 x 750 x 1500 mm	1	1495K6CBKWB15TW
1030 x 750 x 1500 mm	1	1495K6CBLWB15TW
1030 x 750 x 1500 mm	1	1495K6CRDWB15TW
1030 x 750 x 1500 mm	1	1495K6CWB15TW
1030 x 750 x 1500 mm	1	1495K7CBKWB15TW
1030 x 750 x 1500 mm	1	1495K7CBLWB15TW
1030 x 750 x 1500 mm	1	1495K7CRDWB15TW
1030 x 750 x 1500 mm	1	1495K7CWB15TW
1030 x 750 x 1500 mm	1	1495K8CBKWB15TW
1030 x 750 x 1500 mm	1	1495K8CBLWB15TW
1030 x 750 x 1500 mm	1	1495K8CRDWB15TW

Kit de Encimera de DM



1495KWB-TD



1030 x 750 x 1500 mm	1	1495KWB15TD
1030 x 750 x 1800 mm	1	1495KWB18TD

Banco de trabajo de 180 cm con encimera de DM y cajonera lateral



1495KCWB18TD



1030 x 750 x 1800 mm	1	1495K6CBKWB18TD
1030 x 750 x 1800 mm	1	1495K6CBLWB18TD
1030 x 750 x 1800 mm	1	1495K6CRDWB18TD
1030 x 750 x 1800 mm	1	1495K6CWB18TD
1030 x 750 x 1800 mm	1	1495K7CBKWB18TD
1030 x 750 x 1800 mm	1	1495K7CBLWB18TD
1030 x 750 x 1800 mm	1	1495K7CRDWB18TD
1030 x 750 x 1800 mm	1	1495K7CWB18TD
1030 x 750 x 1800 mm	1	1495K8CBKWB18TD
1030 x 750 x 1800 mm	1	1495K8CBLWB18TD
1030 x 750 x 1800 mm	1	1495K8CRDWB18TD
1030 x 750 x 1800 mm	1	1495K8CWB18TD

Banco de trabajo de 180 cm con encimera de madera y cajonera lateral



1495KCWB18TW



1030 x 750 x 1800 mm	1	1495K6CBKWB18TW
1030 x 750 x 1800 mm	1	1495K6CBLWB18TW
1030 x 750 x 1800 mm	1	1495K6CRDWB18TW
1030 x 750 x 1800 mm	1	1495K6CWB18TW
1030 x 750 x 1800 mm	1	1495K7CBKWB18TW
1030 x 750 x 1800 mm	1	1495K7CBLWB18TW
1030 x 750 x 1800 mm	1	1495K7CRDWB18TW
1030 x 750 x 1800 mm	1	1495K7CWB18TW
1030 x 750 x 1800 mm	1	1495K8CBKWB18TW
1030 x 750 x 1800 mm	1	1495K8CBLWB18TW
1030 x 750 x 1800 mm	1	1495K8CRDWB18TW
1030 x 750 x 1800 mm	1	1495K8CWB18TW

Kit de Encimera de madera



1495KWB-TW



1030 x 750 x 1500 mm	1	1495KWB15TW
1030 x 750 x 1800 mm	1	1495KWB18TW

Kit de encimera de acero



1495KW-TS



1030 x 750 x 1500 mm	1	1495KWB15TS
1030 x 750 x 1800 mm	1	1495KWB18TS



Banco de trabajo con encimera de DM



1495WB-TD



1030 x 750 x 1500 mm	1	1495WB15TDGR
1030 x 750 x 1500 mm	1	1495WB15TD
1030 x 750 x 1800 mm	1	1495WB18TDGR
1030 x 750 x 1800 mm	1	1495WB18TD

GR: Gris

Banco de trabajo 1.500m altura ajustable encimera madera



1495WBAH-TD



810 x 750 x 1500 mm	1	1495WBAH15TDGR
810 x 750 x 1500 mm	1	1495WBAH15TD
1030 x 750 x 1800 mm	1	1495WBAH18TDGR
810 x 750 x 1800 mm	1	1495WBAH18TD

GR: Gris

Bandeja inferior para bancos de trabajo



1495WB1-AC



30 x 504 x 1500 mm	1	1495WB15-AC1
30 x 504 x 1800 mm	1	1495WB18-AC1
30 x 500 x 1500 mm	1	1495WB15-AC1GR
30 x 504 x 1800 mm	1	1495WB18-AC1GR

GR: Gris

Banco de trabajo con encimera de acero



1495WB-TS



1030 x 750 x 1500 mm	1	1495WB15TSBK
1030 x 750 x 1500 mm	1	1495WB15TSBL
1030 x 750 x 1500 mm	1	1495WB15TSRED
1030 x 750 x 1500 mm	1	1495WB15TS
1030 x 750 x 1800 mm	1	1495WB18TSBK
1030 x 750 x 1800 mm	1	1495WB18TSBL
1030 x 750 x 1800 mm	1	1495WB18TSRED
1030 x 750 x 1800 mm	1	1495WB18TS

BK: negro / BL: Azul / RED: Rojo

Banco de trabajo 1.500m altura ajustable encimera acero



1495WBAH-TS



810 x 750 x 1500 mm	1	1495WBAH15TS
810 x 750 x 1500 mm	1	1495WBAH15TSBK
810 x 750 x 1500 mm	1	1495WBAH15TSBL
810 x 750 x 1500 mm	1	1495WBAH15TSRED
810 x 750 x 1800 mm	1	1495WBAH18TS
810 x 750 x 1800 mm	1	1495WBAH18TSBK
810 x 750 x 1800 mm	1	1495WBAH18TSBL
810 x 750 x 1800 mm	1	1495WBAH18TSRED

BK: negro / BL: Azul / RED: Rojo

Banco de trabajo plegable con encimera de DM y chapa galvanizada



1495FWBTD



840 x 510 x 970 mm	1	1495FWB097TD
840 x 510 x 1200 mm	1	1495FWB120TD

Banco de trabajo con encimera de madera



1495WB-TW



1030 x 750 x 1500 mm	1	1495WB15TWGR
1030 x 750 x 1500 mm	1	1495WB15TW
1030 x 750 x 1800 mm	1	1495WB18TWGR
1030 x 750 x 1800 mm	1	1495WB18TW

GR: Gris

Banco de trabajo 1.500m altura ajustable encimera madera



1495WBAH-TW



810 x 750 x 1500 mm	1	1495WBAH15TW
810 x 750 x 1500 mm	1	1495WBAH15TWGR
1030 x 750 x 1800 mm	1	1495WBAH18TW
810 x 750 x 1800 mm	1	1495WBAH18TWGR

GR: Gris

Banco de trabajo plegable con encimera galvanizada



1495FWBTS



840 x 510 x 970 mm	1	1495FWB097TS
840 x 510 x 1200 mm	1	1495FWB120TS

ARMARIOS Y PANELES

Armario con persiana



1495CS1

mm	
900 x 170 x 1500 mm	1 1495CS15BK
900 x 170 x 1500 mm	1 1495CS15BL
900 x 170 x 1500 mm	1 1495CS15RED
900 x 170 x 1800 mm	1 1495CS18BK
900 x 170 x 1800 mm	1 1495CS18BL
900 x 170 x 1800 mm	1 1495CS18RED
900 x 170 x 1500 mm	1 1495CS15
900 x 170 x 1800 mm	1 1495CS18

BK: negro / BL: Azul / RED: Rojo

Panel de herramientas

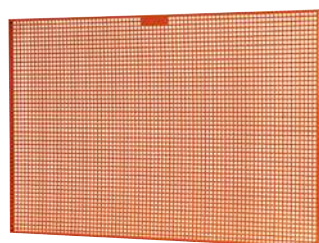

1495TP

mm	
500 x 25 x 600 mm	1 1495TP06GR
795 x 25 x 1200 mm	1 1495TP12GR
795 x 25 x 1495 mm	1 1495TP15GR
793 x 25 x 1800 mm	1 1495TP18GR
500 x 23 x 600 mm	1 1495TP06
795 x 25 x 1200 mm	1 1495TP12
795 x 23 x 1500 mm	1 1495TP15
795 x 23 x 1800 mm	1 1495TP18

GR: Gris

Panel de herramientas con ruedas



1495TP10W

1500 x 450 x 1000 mm	1 1495TP10W
----------------------	-------------

Armario mural 2 puertas



1495CD60

900 x 250 x 602 mm	1 1495CD60BK
900 x 250 x 602 mm	1 1495CD60BL
900 x 250 x 602 mm	1 1495CD60RED
900 x 250 x 602 mm	1 1495CD60

BK: negro / BL: Azul / RED: Rojo

Armario 2 puertas sobre ruedas



1495CD60W

1605 x 450 x 625 mm	1 1495CD60W
1605 x 450 x 625 mm	1 1495CD60WBK
1605 x 450 x 625 mm	1 1495CD60WBL
1605 x 450 x 625 mm	1 1495CD60WRED

BK: negro / BL: Azul / RED: Rojo

Juego de ganchos - 24 piezas

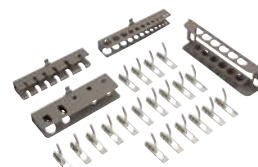

1495CD-AC1

1.22 kg	1 1495CD-AC1
---------	--------------

Juego de ganchos - 35 piezas

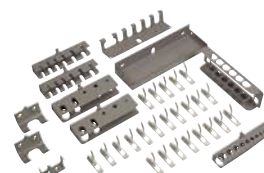

1495CS-AC1

2.11 kg	1 1495CS-AC1
---------	--------------

Adaptadores para el panel y banco de trabajo



1495TP-AC1

9.5 kg	1 1495TP-AC1
--------	--------------

Soporte para 12 llaves fijas - combinadas ..
165x42x333mm



1495TP-AC10

0.43 kg	1 1495TP-AC10
---------	---------------



Soporte para 6 botadores 213x30x65mm



1495TP-AC11

kg 0.16 kg 1 1495TP-AC11

Juego de soporte y bandeja para vasos 260x80x40mm



1495TP-AC3

kg 0.45 kg 1 1495TP-AC3

Soporte para Tenaza Grip 46x75x36mm



1495TP-AC7

kg 0.79 kg 1 1495TP-AC7

Soporte para martillo 70x48x46mm



1495TP-AC12

kg 0.07 kg 1 1495TP-AC12

Bandeja de plástico 100x90x50mm



1495TP-AC4

kg 0.125 kg 1 1495TP-AC4

Soporte para 12 llaves hexagonales 180x33x25mm



1495TP-AC8

kg 0.12 kg 1 1495TP-AC8

Soporte para mango en T 56x37x27mm



1495TP-AC13

kg 0.04 kg 1 1495TP-AC13

Soporte para 6 destornilladores 166x30x26mm

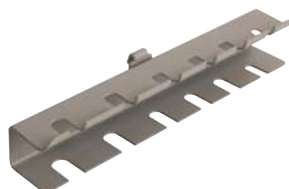

1495TP-AC5

kg 0.14 kg 1 1495TP-AC5

Soporte para 12 llaves de tubo 74x50x398mm



1495TP-AC9

kg 0.43 kg 1 1495TP-AC9

Bandeja 238x125x40mm



1495TP-AC2

kg 0.44 kg 1 1495TP-AC2

Soporte para 5 alicates 175x55x26mm



1495TP-AC6

kg 0.17 kg 1 1495TP-AC6

Ganchos para armarios y paneles (x5)



1495TP-ACH

kg 0.116 kg 5 1495TP-ACHL20
0.125 kg 5 1495TP-ACHL40
0.144 kg 5 1495TP-ACHL65
0.17 kg 1 1495TP-ACHL90
0.102 kg 1 1495TP-ACHU20

kg



0.125 kg	1	1495TP-ACHU40
0.146 kg	1	1495TP-ACHU65
0.162 kg	1	1495TP-ACHU90

CAJAS DE HERRAMIENTAS METÁLICAS

Caja metálica 2 cajones



1483K2RB

277 x 257 x 525 mm	8200	1 1483K2RB

Caja metálica 3 cajones



1483K3RB

334 x 260 x 523 mm	10200	1 1483K3RB

Caja metálica 3 cajones con tapa reforzada



1483KHD3RB

305 x 233 x 523 mm	13050	1 1483KHD3RB

Caja metálica 4 cajones con tapa reforzada



1483KHD4RB

390 x 260 x 593 mm	15200	1 1483KHD4RB

Carretilla para cajas metálicas 1483K



1483CART

200 x 270 x 655 mm	6.02 kg	1 1483CART

Caja metálica de albañil



1496MB2

290 x 315 x 552 mm	40	1 1496MB2

Caja metálica de albañil



1496MB3

310 x 380 x 710 mm	60	1 1496MB3

Caja metálica de albañil



1496MB4

340 x 460 x 850 mm	80	1 1496MB4

Caja metálica de albañil



1496MB5

530 x 530 x 910 mm	150	1 1496MB5



Caja de herramientas con 3 compartimentos

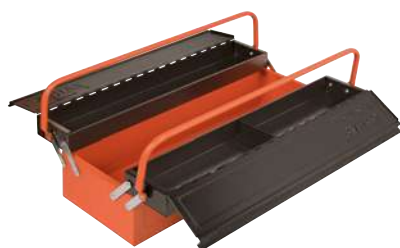

1497MBF350

160 x 200 x 530 mm	10	1	1497MBF350

Caja de herramientas con 5 compartimentos

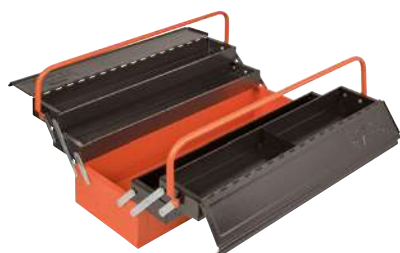

1497MBF550

200 x 200 x 530 mm	12	1	1497MBF550

Caja de herramientas con 7 compartimentos



1497MBF750

250 x 200 x 530 mm	15	1	1497MBF750

Caja de herramientas para taller



3149-OR

220 x 220 x 560 mm	4370	1	3149-OR

Caja de herramientas metálica



9601

270 x 210 x 335 mm	2450	1	960100010
275 x 210 x 435 mm	3400	1	960100020
275 x 210 x 535 mm	3670	1	960100030
315 x 210 x 435 mm	4400	1	960100050
325 x 210 x 535 mm	4840	1	960100060

Caja metálica con ruedas



1497MBW

637 x 400 x 1203 mm	250	1	1497MBW

MALETAS RÍGIDAS

Foam para maleta 4750RCHD01, 15 piezas



FF2A10

49 x 330 x 435 mm	1	FF2A10

2101GC-160IP	
2427 GC-200IP	
2628 GC-160IP	
2632	
2650	
2855	
2979 D-180	
3625N-32	
3734-2, 3734-3, 3734-4, 3734-5	
3735-4-120	
481-300	
8224CIP	

Maleta con ruedas extra fuerte



4750RCHDW02

290 x 480 x 630 mm	1	4750RCHDW02

Copolimero inyectado en estructura de resina en polipropileno

Maleta rígida con ruedas Extra Fuerte



4750RCHDW01

240 x 350 x 545 mm	1 4750RCHDW01RED
240 x 350 x 545 mm	1 4750RCHDW01

estructura de resina en polipropileno

Maleta rígida copolimero extra fuerte



4750RCHD01

215 x 415 x 465 mm	1 4750RCHD01

Maleta rígida extra fuerte con separadores



4750RCHD011

215 x 415 x 465 mm	1 4750RCHD011

Maleta rígida extra fuerte



4750RCHD00

205 x 345 x 400 mm	1 4750RCHD00

Maleta rígida extra fuerte con cuatro cajones



4750RCWD4

453 x 340 x 575 mm	1 4750RCWD4
453 x 340 x 575 mm	1 4750RCWD4-OR

Maleta rígida con ruedas



4750RCW01

255 x 410 x 465 mm	1 4750RCW01
255 x 405 x 465 mm	1 4750RCW011

4750RCW01 con bolsillos transparentes 4750RCW011
con cintas goma de sujeción en tapa y parte baja

Maleta rígida



4750RC02

210 x 410 x 450 mm	1 4750RC02
210 x 410 x 455 mm	1 4750RC021

4750RC02: Bolsillos transparentes en el lateral
4750RC021: Gomas de sujeción en el lateral

Maleta rígida



4750RC01

160 x 390 x 430 mm	1 4750RC01

Juego de ruedas giratorias (x4) 50x18mm



4750RCWD-AC1

100 x 50 x 200 mm	1 4750RCWD-AC1

Para 4750RCWD4



Divisor pivotante para colocar bajo la tapa con huecos tipo bolsa



4750RCWD-AC2

 30 x 277 x 507 mm   1 4750RCWD-AC2

Panel desmontable tapa acolchada



4750RCHD01AC1

 35 x 305 x 425 mm   1 4750RCHD01AC1

Bolsa acolchado extraible



4750RCHDW01AC2

 120 x 280 x 525 mm   1 4750RCHDW01AC2

Divisor pivotante para colocar bajo la tapa con tiras elásticas



4750RCWD-AC3

 5 x 277 x 507 mm   1 4750RCWD-AC3

Bolsa acolchada extraible para maleta 4750RCHD01



4750RCHD01AC2

 135 x 360 x 450 mm   1 4750RCHD01AC2

Candado TSA homologado para maleta 4750RCHD



4750RCHD-AC1

 20 x 40 x 70 mm   1 4750RCHD-AC1

Foam para maleta 4750RCHD01, 64 piezas



FF2A07

 45 x 330 x 430 mm   1 FF2A07

Panel fijo para colocar bajo la tapa con tiras elásticas





4750RCWD-AC4









 4 x 286 x 490 mm   1 4750RCWD-AC4

Panel desmontable tapa acolchada



4750RCHDW01AC1

 50 x 204 x 500 mm   1 4750RCHDW01AC1

- A6700DZ-1/2, A6700DZ-1/4, A6700DZ-11/32, A6700DZ-3/16, A6700DZ-3/8, A6700DZ-5/16, A6700DZ-7/16, A6700DZ-7/32, A6700DZ-9/16, A6700DZ-9/32  
- A6710DZ-3/8, A6710DZ-5/16, A6710DZ-7/16  
- A6800DZ-1/2, A6800DZ-1/4, A6800DZ-11/32, A6800DZ-3/16, A6800DZ-3/8, A6800DZ-5/16, A6800DZ-7/16, A6800DZ-7/32, A6800DZ-9/16, A6800DZ-9/32  
- A7400DZ-1/2, A7400DZ-11/16, A7400DZ-13/16, A7400DZ-19/32, A7400DZ-3/4, A7400DZ-3/8, A7400DZ-5/8, A7400DZ-7/16, A7400DZ-7/8, A7400DZ-9/16  

A7402DZ-1/2, A7402DZ-11/16, A7402DZ-13/16, A7402DZ-19/32, A7402DZ-3/4, A7402DZ-3/8, A7402DZ-5/8, A7402DZ-7/16, A7402DZ-7/8, A7402DZ-9/16	
6950SL	
6954	
6956	
6960, 6962, 6962L	
6966	
6972H	
7407H, 7408H	
7750SL	
7752	
7760, 7761, 7762	
7764	
7765	
7766	
8164-1/2	
A6710DZ-1/4	

Foam para maleta 4750RCHD01, 24 piezas



FF2A08	
45 x 335 x 435 mm	1 FF2A08
1-100-04-2-2	
1-230-04-2-2	
111Z-1, 111Z-1/2, 111Z-1/4, 111Z-11/16, 111Z-3/4, 111Z-3/8, 111Z-5/16, 111Z- 5/8, 111Z-7/16, 111Z-9/16	
1177-SCRIBE	
1320RZ-1/2-9/16, 1320RZ-1/4-5/16, 1320RZ-3/8-7/16	
1931Z-1/4, 1931Z-3/16, 1931Z-7/32	
1950MZ-3/8	
208	
111Z-7/8	
9031 C	

Foam para maleta 4750RCHD01, 56 piezas



FF2A09	
45 x 335 x 440 mm	1 FF2A09
BE-8040, BE-8210	
BE-8260	
BE-8600, BE-8610, BE-8620	
BE-9780	
MTB-3-16-E	
2047-1-5.5	
2047PR-1-2	
59/S28-4	
2509	
2535F2	
5515T-52	
808050	
BE-8150	

Foam para maleta 4750RCHD01, 61 piezas



FF2B01	
40 x 270 x 505 mm	1 FF2B01
A6700DZ-1/2, A6700DZ-1/4, A6700DZ-11/32, A6700DZ-3/16, A6700DZ-3/8, A6700DZ-5/16, A6700DZ-7/16, A6700DZ-7/32, A6700DZ-9/16, A6700DZ-9/32	
A6800DZ-1/2, A6800DZ-1/4, A6800DZ-11/32, A6800DZ-3/16, A6800DZ-3/8, A6800DZ-5/16, A6800DZ-7/16, A6800DZ-7/32, A6800DZ-9/16, A6800DZ-9/32	
A7400DZ-1/2, A7400DZ-1/4, A7400DZ-11/16, A7400DZ-17/32, A7400DZ-19/32, A7400DZ-3/4, A7400DZ-3/8, A7400DZ-5/16, A7400DZ-5/8, A7400DZ-7/16, A7400DZ-9/16	
A7402DZ-1/2, A7402DZ-1/4, A7402DZ-11/16, A7402DZ-19/32, A7402DZ-3/4, A7402DZ-3/8, A7402DZ-5/16, A7402DZ-5/8, A7402DZ-7/16, A7402DZ-9/16	

6950SL	
6954	
6956	
6958	
6960, 6961, 6962L	
6966	
6972H	
7407H	
7750SL	
7752	
7760, 7761, 7762	
7764	
7765	
7766	
8164-1/2	

Foam para maleta 4750RCHD01, 69 piezas

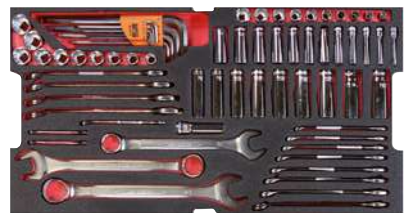

FF2B02	
39 x 270 x 505 mm	1 FF2B02
A6700DM-5.5, A6700DM-6, A6700DM-11, A6700DM-12, A6700DM-13, A6700DM-14, A6700DM-7, A6700DM-8, A6700DM-9, A6700DM-10	
A6800DM-6, A6800DM-7, A6800DM-8, A6800DM-9, A6800DM-4, A6800DM-5, A6800DM-5.5, A6800DM-14, A6800DM-10, A6800DM-11, A6800DM-12, A6800DM-13	
A7400DM-10, A7400DM-14, A7400DM-15, A7400DM-16, A7400DM-11, A7400DM-12, A7400DM-17, A7400DM-18, A7400DM-19	
A7402DM-19, A7402DM-15, A7402DM-16, A7402DM-17, A7402DM-18, A7402DM-11, A7402DM-12, A7402DM-13, A7402DM-14, A7402DM-10	
BE-9770	
A7400DM-13	
111M-24, 111M-6, 111M-7, 111M-12, 111M-13, 111M-14, 111M-15, 111M-8, 111M-9, 111M-10, 111M-11, 111M-22, 111M-16, 111M-17, 111M-18, 111M-19	
4020L-M-5, 4020L-M-5.5	



Foam para maleta 4750RCHDW01, 44 piezas



FF2B03

35 x 270 x 505 mm 1 FF2B03

A6710DM-7		
A6710DZ-1/2, A6710DZ-1/4, A6710DZ-11/32, A6710DZ-3/16, A6710DZ-3/8, A6710DZ-5/16, A6710DZ-7/16, A6710DZ-7/32, A6710DZ-9/16, A6710DZ-9/32		
BE-9780		
111Z-1, 111Z-1/2, 111Z-1/4, 111Z-11/16, 111Z-3/4, 111Z-3/8, 111Z-5/16, 111Z- 5/8, 111Z-7/16, 111Z-7/8, 111Z-9/16		
1320RZ-1/2-9/16, 1320RZ-1/4-5/16, 1320RZ-3/8-7/16		
1931Z-1/4, 1931Z-3/16, 1931Z-7/32		
1950MZ-3/8		
111Z-13/16		

Foam para maleta 4750RCHDW01, 45 piezas



FF2B04

42 x 270 x 505 mm 1 FF2B04

BE-8020L, BE-8040		
BE-8080-10		
BE-8150, BE-8255		
BE-8610, BE-8620		
1544		
2509		
59/S28-4		
2535F2		
5516		
700-1.5-50, 700-1-50		
701-0-50, 701-00-50		
808050		
9070C		

Foam para maleta 4750RCHDW01, 15 piezas



FF2B05

35 x 270 x 510 mm 1 FF2B05

1150-1/2H/P		
MTB-3-16-M-E		
2101GC-125IP, 2101GC-160IP		
2427 GC-200IP		
2628 GC-160IP		
2650		
2820EF2		
2855		
4130		
4830		
5515T-52		
8224CIP		

Foam para maleta 4750RCHDW01, 6 piezas



FF2B06

35 x 122 x 355 mm 1 FF2B06

3625N-32		
3734-5, 3734-8, 3734-3		
3735-5-120		
481-300		

Foam para maleta 4750RCHDW01, 62 piezas



FF2B07

35 x 270 x 505 mm 1 FF2B07

A6700DZ-1/2, A6700DZ-1/4, A6700DZ-11/32, A6700DZ-3/16, A6700DZ-3/8, A6700DZ-5/16, A6700DZ-7/16, A6700DZ-7/32, A6700DZ-9/16, A6700DZ-9/32		
A6710DZ-3/8, A6710DZ-5/16, A6710DZ-7/16		
A6800DZ-1/2, A6800DZ-1/4, A6800DZ-11/32, A6800DZ-3/16, A6800DZ-3/8, A6800DZ-5/16, A6800DZ-7/16, A6800DZ-7/32, A6800DZ-9/16, A6800DZ-9/32		
A7400DZ-1/2, A7400DZ-11/16, A7400DZ-13/16, A7400DZ-19/32, A7400DZ-3/4, A7400DZ-3/8, A7400DZ-5/8, A7400DZ-7/16, A7400DZ-7/8, A7400DZ-9/16		
A7402DZ-1/2, A7402DZ-11/16, A7402DZ-13/16, A7402DZ-19/32, A7402DZ-3/4, A7402DZ-3/8, A7402DZ-5/8, A7402DZ-7/16, A7402DZ-7/8, A7402DZ-9/16		
6950SL		
6954		
6956		
6960, 6962, 6962L		
6966		
6972H		
7407H, 7408H		
7750SL		
7752		
7760, 7761, 7762		
7764		
7765		
7766		
8164-1/2		

Foam para maleta 4750RCHDW01, 25 piezas



FF2B08

44 x 270 x 505 mm 1 FF2B08

1-100-04-2-2	
1-230-04-2-2	
111Z-1, 111Z-1/2, 111Z-1/4, 111Z-11/16, 111Z-3/4, 111Z-3/8, 111Z-5/16, 111Z-5/8, 111Z-7/16, 111Z-7/8, 111Z-9/16	
1177-SCRIBE	
1320RZ-1/2-9/16, 1320RZ-1/4-5/16, 1320RZ-3/8-7/16	
1931Z-1/4, 1931Z-3/16, 1931Z-7/32	
1950MZ-3/8	
208	
9031 C	

Foam para maleta 4750RCHDW01, 56 piezas



FF2B09

47 x 270 x 505 mm 1 FF2B09

BE-8040	
BE-8150	
BE-8210	
BE-8260	
BE-8600, BE-8610, BE-8620	
BE-9780	
MTB-3-16-E	
2047-1-5.5	
2047PR-1-2	
2509	
2535F2	
5515T-52	
59/S28-4	
808050	

Foam para maleta 4750RCHDW01, 9 piezas



FF2B10

37 x 270 x 505 mm 1 FF2B10

2101GC-160IP	
2427 GC-200IP	
2430 GC-200 IP	
2628 GC-160IP	
2650	
2744	
2855	
2979 D-180	
8224CIP	

Foam para maleta 4750RCHDW01, 7 piezas



FF2B11

39 x 122 x 355 mm 1 FF2B11

2632	
3625N-32	
3734-2, 3734-3, 3734-4, 3734-5	
481-300	

Foam para maleta 4750RCHDW01, 92 piezas



FF2B12

44 x 270 x 505 mm 1 FF2B12

A6800DM-6, A6800DM-7, A6800DM-8, A6800DM-9, A6800DM-5.5, A6800DM-10, A6800DM-11, A6800DM-12, A6800DM-13	
A7402DM-19, A7402DM-15, A7402DM-16, A7402DM-17, A7402DM-18, A7402DM-11, A7402DM-12, A7402DM-13, A7402DM-14, A7402DM-10	
6700SM-5.5, 6700SM-6, 6700SM-11, 6700SM-12, 6700SM-13, 6700SM-7, 6700SM-8, 6700SM-9, 6700SM-10	
6709M-3, 6709M-4, 6709M-5, 6709M-6, 6709M-8	
6709PH-1, 6709PH-2, 6709PH-3	
6709TORX-T20, 6709TORX-T25, 6709TORX-T27, 6709TORX-T30, 6709TORX-T8, 6709TORX-T9, 6709TORX-T10, 6709TORX-T15, 6709TORX-T40	
6954	
6956	
6958	
6960, 6961, 6962, 6962L	
6966	
6972H	
7400SM-6, 7400SM-11, 7400SM-12, 7400SM-13, 7400SM-14, 7400SM-7, 7400SM-8, 7400SM-9, 7400SM-10, 7400SM-19, 7400SM-22, 7400SM-15, 7400SM-16, 7400SM-17, 7400SM-18	
7407H	
7409M-8, 7409M-10, 7409M-4, 7409M-5, 7409M-6, 7409M-7, 7409M-3	
7409TORX-T25, 7409TORX-T27, 7409TORX-T30, 7409TORX-T40, 7409TORX-T45, 7409TORX-T50	
7750SL	
7761, 7762	
7764	
7765	
7766	
7760	
8164-1/2	
6950SL	



Foam para maleta 4750RCHDW01, 39 piezas



FF2B13

50 x 270 x 505 mm 1 FF2B13

BE-9770	
111M-12, 111M-13, 111M-14, 111M-15, 111M-8, 111M-9, 111M-10, 111M-11, 111M-6, 111M-7, 111M-21, 111M-22, 111M-16, 111M-17, 111M-18, 111M-19	
6M-6-7, 6M-8-9, 6M-10-11, 6M-12-13, 6M-14-15, 6M-16-17, 6M-18-19, 6M-20-22	
9070C	
1177-SCRIBE	
2535F2	
7758	
7754	

Foam para maleta 4750RCHDW01, 48 piezas



FF2B14

35 x 270 x 505 mm 1 FF2B14

BE-8020L, BE-8030	
BE-8155	
BE-8260	
BE-8350	
BE-8601, BE-8602	
BE-8610, BE-8620	
BE-8630	
1544	
2047-0.8-4	
2047PR-1-2	
2509	
808050P	
808050S	
59S/31-1	

Foam para maleta 4750RCHDW01, 9 piezas



FF2B15

35 x 270 x 505 mm 1 FF2B15

1150-1/2H/P	
2101GC-160IP	
2427 GC-200IP	
2430 GC-200 IP	
2628 GC-160IP	
2820EF2	
5515T-52	
8224CIP	
MTB-3-16-E	

Foam para maleta 4750RCHDW01, 6 piezas



FF2B16

34 x 122 x 355 mm 1 FF2B16

3625W-35	
3734-3, 3734-5, 3734-8	
3735-4-120	
481-300	

COMPOSICIONES DE HERRAMIENTAS POR APLICACION

Maleta rígida 4750RCWD4 con 162 herramientas



4750RCWD4FF1

453 x 340 x 575 mm 1 4750RCWD4FF1

4750RCWD4	
6700SM-10, 6700SM-9, 6700SM-12, 6700SM-11, 6700SM-6, 6700SM-8, 6700SM-7, 6700SM-13	
A6800DM-13, A6800DM-12, A6800DM-9, A6800DM-8, A6800DM-11, A6800DM-10, A6800DM-5.5, A6800DM-7, A6800DM-6	
6709M-3, 6709M-8, 6709M-6, 6709M-5, 6709M-4	
6709PH-1, 6709PH-3, 6709PH-2	
6709TORX-T30, 6709TORX-T27, 6709TORX-T40, 6709TORX-T15, 6709TORX-T10, 6709TORX-T25, 6709TORX-T20, 6709TORX-T9, 6709TORX-T8	
6950SL	
6954	
6956	
6958	
6960, 6962, 6962L	
6966	
6972H	
7764	
7800SM-25, 7800SM-24, 7800SM-27, 7800SM-26, 7800SM-21, 7800SM-23, 7800SM-22, 7800SM-17, 7800SM-16, 7800SM-19, 7800SM-18, 7800SM-13, 7800SM-12, 7800SM-15, 7800SM-14, 7800SM-9, 7800SM-8, 7800SM-11, 7800SM-10, 7800SM-28, 7800SM-32, 7800SM-30	
7809TORX-T45, 7809TORX-T25, 7809TORX-T50, 7809TORX-T30, 7809TORX-T27, 7809TORX-T40	
8150RN-1/2	
8159-1/2, 8160-1/2, 8162-1/2	
8166-1/2	
111M-30, 111M-32, 111M-27, 111M-29, 111M-24, 111M-19, 111M-18, 111M-21, 111M-15, 111M-14, 111M-17, 111M-16, 111M-11, 111M-10, 111M-13, 111M-12, 111M-7, 111M-6, 111M-9, 111M-8	
9070C	
BE-9770	

59/S31	
1544	
MTB-3-16	
2101G-160IP	
2427 G-200 IP	
2430 G-200 IP	
2628 G-160IP	
8224 IP	
1150-1/2H/P	
5515T-52	
2820EF2	
481-300	
3625W-35	
8158-1/2	
8154-1/2	
3734-3, 3734-5, 3734-8	
3735-4-120	
1177-SCRIBE	

Armario con persiana 1495CS18 + 981001100, ganchos incluidos



1495CS18TS1

900 x 170 x 1800 mm	1 1495CS18TS1

1495CS18	
981001100	

Armario con puertas 1495CD60 + 981001100, ganchos incluidos



1495CD60TS1

900 x 250 x 602 mm	1 1495CD60TS1

1495CD60	
981001100	

Armario con persiana 1495CS15 + 981001100, ganchos incluidos



1495CS15TS1

900 x 170 x 1500 mm	1 1495CS15TS1

1495CS15	
981001100	

Maleta rígida 4750RCHDW01 con 194 herramientas



4750RCHDW01FF3

250 x 345 x 545 mm	1 4750RCHDW01FF3

4750RCHDW01	
FF2B12	
FF2B13	
FF2B14	
FF2B15	
FF2B16	

Maleta cuero con dotación universal 32 htas



982000320

280 x 200 x 435 mm	1 982000320

4750-FOLTG-1	
2101D-160IP	
224 D	
2630D-180	
2430 D-160 IP	
8071 C IP	
483-20	
6M/8C	
541D-180	
2951-180	
B191.030.075, B191.040.100	
B190.100.200, B190.065.150	
B192.001.100, B192.002.125	
SC127	
2820EF2	
BE-9777	
MTB-3-16	

FF1ASET-MAX - 195 piezas



FF1ASET-MAX

265 x 595 x 790 mm	1 FF1ASET-MAX

FF1A5023	
FF1A5024	



Maleta rígida con dotación de 32 herramientas



983000320



162 x 380 x 435 mm



1 983000320

Set 32 herramientas: TS001

4750RC01	
2101D-160IP	
224 D	
2630D-180	
2430 D-160 IP	
8071 C IP	
6M/8C	
483-20	
541D-180	
2951-180	
B191.030.075, B191.040.100	
B190.100.200, B190.065.125	
B192.001.100, B192.002.125	
SC127	
2820EF2	
BE-9777	
MTB-3-16	

Maleta rígida con dotación 32 herramientas



983100320



210 x 415 x 460 mm



1 983100320

BAHCO

4750RC02	
2101D-160IP	
224 D	
2630D-180	
2430 D-160 IP	
8071 C IP	
483-20	
541D-180	
2951-180	
6M/8C	
B191.030.075, B191.040.100	
B190.100.200, B190.065.150	
B192.001.100, B192.002.125	
SC127	
2820EF2	
BE-9777	
MTB-3-16	

Maleta rígida con ruedas con 32 herramientas



984010320



255 x 390 x 465 mm



1 984010320

Dotación: TS001

4750RCW01	
2101D-160IP	
224 D	
2630D-180	
2430 D-160 IP	
6M/8C	
8071 C IP	
483-20	
541D-180	
2951-180	
B191.030.075, B191.040.100	
B190.100.200, B190.065.150	
B192.001.100, B192.002.125	
SC127	
2820EF2	
BE-9777	
MTB-3-16	

Foam para caja de herramientas 1483K y 1483KHD, 93 piezas



FF3A01



64 x 245 x 505 mm



1 FF3A01

A6700DZ-1/2, A6700DZ-1/4, A6700DZ-11/32, A6700DZ-3/8, A6700DZ-5/16, A6700DZ-7/16, A6700DZ-7/32, A6700DZ-9/32		
A6710DZ-3/8, A6710DZ-5/16, A6710DZ-7/16		
A6800DZ-1/4, A6800DZ-5/16, A6800DZ-7/32, A6800DZ-9/32		
A7400DM-10, A7400DM-13		
A7400DZ-1/2, A7400DZ-11/16, A7400DZ-3/4, A7400DZ-5/8, A7400DZ-9/16		
A7402DZ-1/2, A7402DZ-3/8, A7402DZ-7/16, A7402DZ-9/16		
1320RZ-1/4-5/16, 1320RZ-3/8-7/16		
59/S28-4		
6Z-1.1/16-1.1/4, 6Z-1.1/8, 6Z-7/8-15/16		
6950SL		
6956		
7750SL		
7752		
7760, 7761		
7764		
7765		
7766		
7800DZ-1, 7800DZ-13/16, 7800DZ-7/8		
8164-1/2		
8165-1/2		

Foam para caja de herramientas 1483K y 1483KHD, 13 piezas



FF3A02



39 x 210 x 445 mm



1 FF3A02

BE-3529	
BE-8020L	
BE-8155	
BE-8260	
BE-8601	
BE-8611, BE-8621	
1150-1/2H/P	
1177-SCRIBE	
2047-1.2-8	
2047PR-1-2	
5515T-52	
9715-14-250	

Foam para caja de herramientas 1483K y 1483KHD, 12 piezas



FF3A03

48 x 210 x 450 mm	1 FF3A03

MTB-3-16-M-E	
2101GC-160IP	
2421GC-180IP	
2855 D	
3658A-2, 3658A-3, 3658A-5	
8224CIP	
0454800500	

Foam para caja de herramientas 1483K y 1483KHD, 20 piezas



FF3A04

45 x 210 x 445 mm	1 FF3A04

1300Z-1/2-9/16, 1300Z-1/4-5/16, 1300Z-3/8-7/16, 1300Z-5/8-3/4, 1300Z-7/8-15/16	
6Z-19/32-11/16, 6Z-25/32-13/16, 6Z-3/8-7/16, 6Z-5/8-3/4	
8158-1/2	
9070C	
6Z-1/4-5/16, 6Z-1/2-9/16	
1931Z-7/32, 1931Z-1/4	
1300Z-19/32-11/16, 1300Z-25/32-13/16	

Foam para caja de herramientas 1483K y 1483KHD, 95 piezas



FF3A05

60 x 245 x 510 mm	1 FF3A05

A6700DZ-1/2, A6700DZ-1/4, A6700DZ-11/32, A6700DZ-3/16, A6700DZ-3/8, A6700DZ-5/16, A6700DZ-7/16, A6700DZ-7/32, A6700DZ-9/16, A6700DZ-9/32	
A6710DZ-1/4, A6710DZ-11/32, A6710DZ-3/8, A6710DZ-5/16, A6710DZ-7/16	
A6800DM-4	
A6800DZ-1/2, A6800DZ-1/4, A6800DZ-11/32, A6800DZ-3/8, A6800DZ-5/16, A6800DZ-7/16, A6800DZ-3/16, A6800DZ-7/32, A6800DZ-9/16, A6800DZ-9/32	
A7400DZ-1/2, A7400DZ-11/16, A7400DZ-13/16	
59/S28-4	
A7400DZ-17/32, A7400DZ-19/32, A7400DZ-3/4, A7400DZ-5/8, A7400DZ-9/16	
BE-9780	
KE18-01	
1544	
59S/TS-1/4	
6950SL	
6956	
6960, 6962	
6966	
6972H	
7407H	
7752	
7750SL	
7760, 7761	
7764	
7765	
7766	
808050	
9071C	
8164-1/2	

Foam para caja de herramientas 1483K y 1483KHD, 15 piezas



FF3A06

40 x 205 x 450 mm	1 FF3A06

BE-8030	
BE-8150, BE-8155	
BE-8260	
BE-8350	
BE-8602	
BE-8610, BE-8620	
1177-SCRIBE	
2047-1-5.5	
2047PR-1-2	
5515T-52	
704Z-3/32	
1150-1/2H/P	

Foam para caja de herramientas 1483K y 1483KHD, 11 piezas



FF3A07

39 x 202 x 450 mm	1 FF3A07

MTB-3-16-E	
2101GC-160IP	
2427 GC-200IP	
2628 GC-160IP	
2632	
2650	
2855	
3734-3, 3734-5, 3734-8	
8224CIP	



Foam para caja de herramientas 1483K y 1483KHD, 23 piezas



FF3A08

43 x 205 x 450 mm 1 FF3A08

1320RZ-1/2-9/16, 1320RZ-1/4-5/16, 1320RZ-3/8-7/16	
1952Z-1/2, 1952Z-1/4, 1952Z-11/16, 1952Z-11/32, 1952Z-13/16, 1952Z-3/4, 1952Z-3/8, 1952Z-5/16, 1952Z-5/8, 1952Z-7/16, 1952Z-7/8, 1952Z-9/16	
6Z-1/2-9/16, 6Z-1/4-5/16, 6Z-13/16-7/8, 6Z-19/32-11/16, 6Z-3/8-7/16, 6Z-5/16-11/32, 6Z-5/8-3/4	

Foam para caja de herramientas 1483K y 1483KHD, 95 piezas



FF3A09

65 x 250 x 515 mm 1 FF3A09

A6800DM-7, A6800DM-6, A6800DM-5.5, A6800DM-11, A6800DM-10, A6800DM-9, A6800DM-8, A6800DM-13, A6800DM-12	
A7402DM-19, A7402DM-18, A7402DM-17, A7402DM-12, A7402DM-11, A7402DM-10, A7402DM-16, A7402DM-15, A7402DM-14, A7402DM-13	
1544	
6700SM-8, 6700SM-7, 6700SM-6, 6700SM-5.5, 6700SM-12, 6700SM-11, 6700SM-10, 6700SM-9, 6700SM-13	
6709M-8, 6709M-6, 6709M-5, 6709M-4, 6709M-3	
6709PH-2, 6709PH-1, 6709PH-3	
6709TORX-T25, 6709TORX-T20, 6709TORX-T15, 6709TORX-T10, 6709TORX-T40, 6709TORX-T30, 6709TORX-T27, 6709TORX-T9, 6709TORX-T8	

6950SL	
6954	
6956	
6958	
6960, 6961, 6962, 6962L	
6966	
6972H	
7400SM-8, 7400SM-7, 7400SM-6, 7400SM-19, 7400SM-18, 7400SM-17, 7400SM-22, 7400SM-12, 7400SM-11, 7400SM-10, 7400SM-9, 7400SM-16, 7400SM-15, 7400SM-14, 7400SM-13	
7407H	
7409M-10, 7409M-8, 7409M-7, 7409M-6, 7409M-5, 7409M-4, 7409M-3	
7409TORX-T27, 7409TORX-T25, 7409TORX-T50, 7409TORX-T45, 7409TORX-T40, 7409TORX-T30	
7750SL	
7754	
7758	
7760, 7761	
7764	
7765	
7766	
8164-1/2	

Foam para caja de herramientas 1483K y 1483KHD, 53 piezas



FF3A10

39 x 205 x 445 mm 1 FF3A10

BE-8020L, BE-8030	
BE-8155	
BE-8260	
BE-8350	
BE-8601, BE-8602	
BE-8610, BE-8620	
BE-9770	
2047-0.8-4	
2047PR-1-2	
808050P	
808050S	
59S/31-1	

Foam para caja de herramientas 1483K y 1483KHD, 12 piezas



FF3A11

39 x 205 x 445 mm 1 FF3A11

1150-1/2H/P	
MTB-3-16	
1177-SCRIBE	
2101GC-160IP	
2427 GC-200IP	
2430 GC-200 IP	
2628 GC-160IP	
3734-3, 3734-5, 3734-8	
3735-4-120	
8224CIP	

Foam para caja de herramientas 1483K y 1483KHD, 28 piezas



FF3A12

45 x 205 x 450 mm 1 FF3A12

111M-6, 111M-21, 111M-19, 111M-18, 111M-22, 111M-13, 111M-12, 111M-11, 111M-10, 111M-17, 111M-16, 111M-15, 111M-14, 111M-9, 111M-8, 111M-7	
2820EF2	
5515T-52	
6M-10-11, 6M-6-7, 6M-12-13, 6M-8-9, 6M-14-15, 6M-16-17, 6M-18-19, 6M-20-22	
9070C	

Foam para caja de herramientas 1483K y 1483KHD, 49 piezas



FF3A13

68 x 245 x 525 mm 1 FF3A13

111M-27, 111M-32, 111M-24, 111M-30	
6M-24-27, 6M-30-32	
7800SM-19, 7800SM-18, 7800SM-17, 7800SM-16, 7800SM-22, 7800SM-21, 7800SM-11, 7800SM-10, 7800SM-15, 7800SM-14, 7800SM-13, 7800SM-12, 7800SM-27, 7800SM-32, 7800SM-30, 7800SM-24	
7807H	
7809M-10, 7809M-12, 7809M-14, 7809M-19, 7809M-17, 7809M-5, 7809M-8, 7809M-6	
7809TORX-T50, 7809TORX-T45, 7809TORX-T60, 7809TORX-T55, 7809TORX-T25, 7809TORX-T20, 7809TORX-T40, 7809TORX-T30, 7809TORX-T27	
7809M-7	
8150SL	
8154-1/2	
8160-1/2, 8162-1/2	
8164-1/2	
8165-1/2	
8166-1/2	
8964	

Foam para caja de herramientas 1483K y 1483KHD, 86 piezas



FF3A14

65 x 247 x 510 mm 1 FF3A14

A6700DZ-1/2, A6700DZ-1/4, A6700DZ-3/8, A6700DZ-5/16, A6700DZ-7/16, A6700DZ-7/32, A6700DZ-9/16, A6700DZ-9/32	
A6800DZ-1/4, A6800DZ-5/16, A6800DZ-7/32, A6800DZ-9/32	
A7400DM-10, A7400DM-13	
A7400DZ-1/2, A7400DZ-11/16, A7400DZ-13/16, A7400DZ-3/4, A7400DZ-5/8, A7400DZ-7/8, A7400DZ-9/16	
A7402DZ-1/2, A7402DZ-3/8, A7402DZ-7/16, A7402DZ-9/16	
111Z-1, 111Z-1.1/8	
59/S28-4	
6Z-1.1/16-1.1/4, 6Z-1-1.1/8	
6Z/8C	
6950SL	
6958	
6960, 6961	
6966	
6972H	
7407H, 7408H	

7750SL	
7752	
7760, 7761	
7764	
7765	
7766	
7800DZ-1, 7800DZ-15/16	
8164-1/2	
8165-1/2	
1952Z-15/16	
A6700DZ-11/32	

Foam para caja de herramientas 1483K y 1483KHD, 14 piezas



FF3A15

40 x 210 x 445 mm 1 FF3A15

BE-3529	
BE-8020L	
BE-8155	
BE-8260	
BE-8601, BE-8602	
BE-8611, BE-8621	
1177-SCRIBE	
2047-1.2-8	
2047PR-1-2	
5515T-52	
9715-14-250	

Foam para caja de herramientas 1483K y 1483KHD, 12 piezas



FF3A16

42 x 210 x 445 mm 1 FF3A16

MTB-3-16-E	
2101GC-160IP	
2421GC-180IP	
3658A-3, 3658A-5, 3658A-8	
3735-5-120	
3740-150	
8224CIP	
2855 D	
0454800500	

Foam para caja de herramientas 1483K y 1483KHD, 30 piezas



FF3A17

48 x 205 x 450 mm 1 FF3A17

BE-9780	
KE18-01	
1300Z-1/4-5/16, 1300Z-3/8-7/16	
1320RZ-1/4-5/16, 1320RZ-3/8-7/16	
1931Z-1/4, 1931Z-7/32	
1952Z-1/2, 1952Z-11/16, 1952Z-11/32, 1952Z-13/16, 1952Z-3/4, 1952Z-5/8, 1952Z-7/8, 1952Z-9/16	
2628 GC-180IP	
7758	

Maleta de cuero con dotación 34 herramientas electro-mecánico



982000350

280 x 200 x 440 mm 1 982000350

Dotación: TS002

4750-FOLTTC-1	
2101GC-160IP	
6224 GC	
2630GC-180IP	
2900-180	
2800-180	
1998M/10T	
8072 C IP	
2951-250	
B190.100.200, B190.065.150	
B192.001.100, B192.002.125	
B190.040.100	
SC127	
6M/8C	
479-16	
2430 GC-200 IP	
1-110-08-2-2	



Maleta rígida 4750RCHDW01 con 240 herramientas



4750RCHDW01FF1

250 x 345 x 545 mm 1 4750RCHDW01FF1

4750RCHDW01	
FF2B01	
FF2B02	
FF2B03	
FF2B04	
FF2B05	
FF2B06	

Maleta rígida 4750RCHDW01 con 159 herramientas



4750RCHDW01FF2

250 x 345 x 545 mm 1 4750RCHDW01FF2

4750RCHDW01	
FF2B07	
FF2B08	
FF2B09	
FF2B10	
FF2B11	

Maleta rígida 4750RCHD01 + FF2A07 + FF2A08 + FF2A09 + FF2A10



4750RCHD01FF1

215 x 410 x 475 mm 1 4750RCHD01FF1

4750RCHD01	
FF2A07	
FF2A08	
FF2A10	
FF2A09	

Set para mantenimiento de gruas de gas y petróleo en el agua
Para trabajos en altura



4750RCHDW01FF4

250 x 345 x 545 mm 1 4750RCHDW01FF4

TAH8075	
TAH479-32	
TAHBE-9777B	
TAHBE-9787	
TAH2820EF2	
TAHBFRL11	
TAH466-250	
TAHPINRELEASER	
TAH380-10	
TAH2101G-160	
TAH2628G-180	
TAH2855	

TAH8224	
TAHSCB140G	
TAHBE-8258	
TAHBE-8241, TAHBE-8252	
TAHBE-8620L, TAHBE-8620	
4750RCHDW01	
4750-HDLB-TAH	
3875-LY6	
3875-LY9	
3875-LY7	
3875-LY5	
3875-RL2	
3875-MHP4	
3875-MHP6	
3875-HB60	

Set para formación de gas y petróleo en el agua
Para trabajos en altura



4750RCHDW01FF9

250 x 345 x 545 mm 1 4750RCHDW01FF9

TAH8073	
TAH84-PODGER	
TAH3640-250-C	
TAH1-143-12-1-2	
TAH479-32	
TAH325	
TAHBE-9777B	
TAH2820EF2	
TAHBFRL11	
TAHPINRELEASER	
TAH380-14	
TAH2101G-140	
TAH2628G-180	
TAH2855	
TAH2958-250	
TAH2484-30	
TAH3734BM-8	
TAHSCB140G	
TAHBE-8257	

TAHBE-8602	
TAH16B-19	
TAH16B-11/16	
TAH16-H8	
TAH8150-1/2	
TAH8158B-1	
TAH7455-300-1	
TAH1949M-14-17	
4750RCHDW01	
4750-HDLB-TAH	
3875-LY6	
3875-LY9	
3875-LY7	
3875-LY5	
3875-RL2	
3875-MHP4	
3875-MHP6	
MTS-5-25	
4750-MTHO-TAH	
3875-HB60	
TAH2487	
TAH466-250	

Set para aerogeneradores heavy duty
Para trabajos en altura



4750RCHDW02FF15

480 x 290 x 630 mm 1 4750RCHDW02FF15

TAH1-100-06-2-4	
TAH1-210-06-2-2	
TAH1-230-06-2-2	
TAH3625PU-50	
TAH489-1100	
TAHBE64520	
TAHPINRELEASER	
TAHSCB140G	
TAH24B-50, TAH24B-46, TAH24B-41, TAH24B-38, TAH24B-36, TAH24B-32, TAH24B-30, TAH24B-27	
TAH8950N/A	

TAH8961	
TAH8953	
TAH7452-2	
7452-7-13, 7452-7-17, 7452-7-19	
TAH7455-300-1	
TAH7435-100	
TAH111M-50, TAH111M-46, TAH111M-41, TAH111M-36, TAH111M-34	
TAH7444SG-M-46, TAH7444SG-M-41, TAH7444SG-M-36, TAH7444SG-M-55, TAH7444SG-M-50	
4750RCHDW02	

Maleta con set para mantenimiento de
aerogeneradores
Para trabajos en altura



4750RCHDW02FF4

305 x 500 x 630 mm 1 4750RCHDW02FF4

TAH9070, TAH9072	
TAH3625W-35	
TAH481-300	
TAHBE-9777B	
TAH2820EF2	
TAH1150-1/2H/P	
TAH1177-SCRIBE	
TAH1544	
TAH2509	
TAH2535F2	
MTS-5-25	
TAHPINRELEASER	
TAH2427G-200	
TAH2430G-200	
TAH2628G-160	
TAH8224	
TAH2484-30	
TAH3734BM-3, TAH3734BM-8, TAH- 3734BM-5	

TAH3755BM-4	
TAHSCB140G	
TAHBE-8030, TAHBE-8020L	
TAHBE-8040S, TAHBE-8050S	
TAHBE-8155	
TAHBE-8220S	
TAHBE-8260	
TAHBE-8620S	
TAHBE-8620	
TAHBE-8630	
TAHBE-8610	
TAHBE-8610S	
TAHBE-8810, TAHBE-8820	
TAHBE-8830	
TAH08-5.5, TAH08-9, TAH08-7, TAH08- 8, TAH08-13, TAH08-6, TAH08-11, TAH08-10, TAH08-12	
TAH6961, TAH6962, TAH6960	
TAH6956-1	
TAH6950	
TAH6966	
TAH6962L	
TAH6958B-1	
TAH16B-27, TAH16B-30, TAH16B-24, TAH16B-22, TAH16B-32, TAH16B-19, TAH16B-21, TAH16B-17, TAH16B-18, TAH16B-11, TAH16B-15, TAH16B-16, TAH16B-13, TAH16B-10, TAH16B-14, TAH16B-12	
TAH16-H8, TAH16-H6, TAH16-H7, TAH16-H5	
TAH16-T40, TAH16-T45, TAH16-T50, TAH16-T55	
TAH8166	
TAH8150-1/2	
TAH8160, TAH8162	
TAH8158B-1	
TAH111M-32, TAH111M-27, TAH111M-24, TAH111M-21, TAH111M-22, TAH111M-19, TAH111M-9, TAH111M-7, TAH111M-8, TAH111M-18, TAH111M-6, TAH111M-16, TAH111M-17, TAH111M-14, TAH111M-15, TAH111M-12, TAH111M-13, TAH111M-10, TAH111M-11, TAH111M-30	
TAH2101G-160	
TAH2047PR-1-2	
TAH2047-0.8-4	
TAH16-H17, TAH16-H19, TAH16-H12, TAH16-H14, TAH16-H10	
TAH16-T60	
4750RCHDW02	



Bolsa 4750FB2-19A con 61 herramientas para mantenimiento



4750FB2-19TS001

500 mm	250	1	4750FB2-19TS001

4750FB2-19A			
BE-8010S, BE-8040S, BE-8050S, BE-8220S			
BE-8610S, BE-8620S, BE-8630S			
BE-8800S, BE-8820S, BE-8830S			
706-4			
PC-12-VEN			
1-210-08-2-2			
2101G-180			
2233 D-200			
2628 G-180			
268			
3830-20-VIP, 3830-25-VIP			
3834-ARBR-730			
4130			
424P-16, 424P-20, 424P-25			
428-16			
484-1250			
806-1-1			
8231			
9031			
SL25			

SET 7 FOAMS PARA MRO, 256 PIEZAS



FF1ASET-MRO2

530 x 600 x 800 mm	1	FF1ASET-MRO2	

FF1A130			
FF1A131			
FF1A132			
FF1A133			
FF1A134			
FF1A135			
FF1A136			

SET 5 FOAMS PARA MRO, 188 PIEZAS



FF1ASET-MRO3

530 x 600 x 800 mm	1	FF1ASET-MRO3	

FF1A138			
FF1A137			
FF1A134			
FF1A139			
FF1A141			

SET 4 FOAMS PARA MRO, 147 PIEZAS



FF1ASET-MRO4

530 x 600 x 800 mm	1	FF1ASET-MRO4	

FF1A143			
FF1A142			
FF1A145			
FF1A134			

SET 3 FOAMS PARA MRO, 84 PIEZAS



FF1ASET-MRO5

530 x 600 x 800 mm	1	FF1ASET-MRO5	

FF1A147			
FF1A146			
FF1A134			

Set de 4 foams para auto



FF1ASET-AUTO6

520 x 600 x 800 mm	1	FF1ASET-AUTO6	

FF1A19			
FF1A72			
FF1A70			
FF1A71			

SET 3 FOAMS PARA AUTO, 140 PIEZAS



FF1ASET-AUTO3

205 x 595 x 790 mm	1 FF1ASET-AUTO3

FF1A28		
FF1A26		
FF1A27		

CAJAS Y ESTUCHES DE PLÁSTICO

Caja plástico con asa 500x295x270



4750PTB50

27	27	3 4750PTB50

Caja plástico con asa 600x305x295



4750PTB60

37	37	3 4750PTB60

Maleta trolley de polipropileno



4750PTBW47

60	25	1 4750PTBW47

Caja de plástico



4750BMC5

0.28 kg	1 4750BMC5
0.32 kg	1 4750BMC6
0.83 kg	1 4750BMC7
0.39 kg	1 4750BMC9
1.56 kg	1 4750BMC10

EQUIPOS TEXTILES Y DE PIEL

Bolsa de herramientas



3100TB

300 x 240 x 410 mm	1 3100TB

Bolsa abierta de 19"



4750FB1-19A

350 x 230 x 500 mm	1 4750FB1-19A

Bolsa abierta de 19" con cubierta



4750FB1-19B

365 x 225 x 480 mm	4 4750FB1-19B



Bolsa de 19" con cremallera



4750FB2-19A



300 x 235 x 500 mm



4 4750FB2-19A

Portaherramientas para electricista de 12"



4750FB3-12



280 x 220 x 300 mm



4 4750FB3-12

Estuche porta herramientas pequeño



4750FB5A



273 x 50 x 168 mm



1 4750FB5A

Bolsa de 24" con cremallera



4750FB2-24A



260 x 255 x 610 mm



2 4750FB2-24A

Bolsa de 18" para ordenador portátil y herramientas



4750FB4-18



370 x 150 x 435 mm



4 4750FB4-18

Estuche porta herramientas mediano



4750FB5B



62 x 275 x 330 mm



1 4750FB5B

Bolsa de 24" sobre ruedas



4750FB2W-24A



385 x 325 x 665 mm



1 4750FB2W-24A

Bolsa para juego de niveles 416-SET



4750-LV-1



85 x 43 x 1800 mm



1 4750-LV-1

51 x 43 x 1800 mm

1 4750-LV-2

Estuche porta herramientas grande



4750FB5C



80 x 305 x 403 mm



8 4750FB5C

BAHCO

Caja de herramientas de cuero de apertura frontal



4750-FOLTC-1



290 x 195 x 440 mm

1 4750-FOLTC-1

Juego de cinturón con 3 bolsas



4750-3PB



234 x 105 x 570 mm

1 4750-3PB-1

Tirantes con pinzas



4750-BWC-1



750 x 20 x 105 mm

1 4750-BWC-1

Maletín para herramientas tubular



4750-TOCST-1



220 x 170 x 495 mm

1 4750-TOCST-1

Bolsa con dos bolsillos



4750-2PP

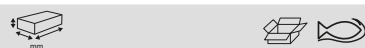

285 x 130 x 265 mm

1 4750-2PP-1

Porta taladro para diestros y zurdos



4750-DHO-3

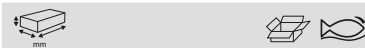

320 x 73 x 175 mm

1 4750-DHO-3

Maleta de cuero para electricista



4750-VDEC



290 x 190 x 445 mm

1 4750-VDEC

Cinturón portaherramientas con tres bolsillos



4750-JU3PB



125 x 55 x 395 mm

1 4750-JU3PB-1

Portaherramientas electricista



4750-EP

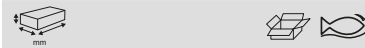

345 x 120 x 260 mm

1 4750-EP-1



Cinturón reforzado y acolchado con hebilla de acero inoxidable de doble pitón.



4750-HDB-2



180 x 10 x 1255 mm



1 4750-HDB-2

Funda para cutter de hoja deslizante



4750-KNHO-1



205 x 35 x 105 mm



1 4750-KNHO-1

Portaherramientas enrollable



4750-ROCO-1



320 x 5 x 370 mm



1 4750-ROCO-1

Cinturón portaherramientas profesional



4750-HDBS-2



320 x 150 x 565 mm



1 4750-HDBS-2

Rodilleras con almohadillas



4750-KP



210 x 50 x 175 mm



1 4750-KP-1

Portaherramientas universal



4750-UP



302 x 140 x 250 mm



1 4750-UP-1

Cinturón de cuero resistente



4750-HDLB



47 x 4 x 1380 mm



1 4750-HDLB-1

Soporte porta herramientas multi uso



4750-MPH-1



240 x 50 x 155 mm



1 4750-MPH-1

Funda vertical para móvil



4750-VMPH-1



170 x 35 x 100 mm



1 4750-VMPH-1

Porta Cutter para la serie ERGO™



4750-KNHO-0



200 x 10 x 85 mm



1 4750-KNHO-0

Cinturón ajustable de zafado rápido en tejido muy resistente



4750-QRFB-1



50 x 4 x 1180 mm



1 4750-QRFB-1

JUEGOS DE HERRAMIENTAS

Juego de herramientas para electrónica



2010

480x330x180	8100	1 2010

1952M-6, 1952M-7, 1952M-8, 1952M-9, 1952M-10, 1952M-11, 1952M-12, 1952M-13, 1952M-14	
4020L-M-3, 4020L-M-3.2, 4020L-M-3.5, 4020L-M-4, 4020L-M-4.5, 4020L-M-5.5	
BE-8340, BE-8350, BE-8355	
700-1.5-50, 700-1.2-50, 700-1-50, 700-1.8-50	
3659/8T	
5550-3.2	
BE-8220S, BE-8050S	
5516 I	
5577-145	
5418	
2535L	
3524	
2648	
1150-1/2H/P	
1952Z-1/4, 1952Z-3/8, 1952Z-1/2	
BE-8620S	
BE-7845, BE-7806	
701-0-50, 701-00-50	
5550-4.5	
8045LVDE	
5574-145	
6x 2-470-16-1-0	
5515GV	
5423	
2665 B-160	
326000300	
328000000	
2656 R	
x BE-3529	
x BE-6400M-4, x BE-6400M-5, x BE-6400M-5.5, x BE-6400M-7	
x BE-8160	
x BE-8255S	
x BE-8600, x BE-8610	

x 1995LM-1.5, x 1995LM-2, x 1995LM-2.5, x 1995LM-3, x 1995LM-4	
x 1997M/10T	
x 2047-0.8-4, x 2047-1-5.5	
x 2421 D-140IP	
x 2430 GC-200 IP	
x 2530-40	
x 2744	
x 4750RC021	
x 7372I-2.5-75	
x 8070 C	
x 2223 S-150	

Juego de 10 herramientas para electricista



3045/1VDE

10	225 x 70 x 300 mm	1 3045/1VDE

BE-8010S, BE-8040S, BE-8050S, BE-8220S, BE-8230S, BE-8255S	
BE-8620S	
2171V-160	
2430V-160	
2678V-180	

Juego de 10 herramientas aisladas
10 piezas



3045V-1

10	60 x 240 x 330 mm	1 3045V-1

2171V-160	
2678V-180	
2223V-160	
BE-8220S, BE-8040S, BE-8050S	
BE-8610S, BE-8620S	
2820VP	
SC127V	

Maleta cuero portaherramientas para electricista
1000V
19 piezas



3045V-2

19	200 x 285 x 445 mm	1 3045V-2

Incluye set 19 herramientas: TS200

2171V-160	
2678V-180	
2430V-160	
2223V-160	
BE-8220S, BE-8040S, BE-8050S, BE-8255S	
BE-8610S, BE-8620S	
6MV-10, 6MV-11, 6MV-13, 6MV-12, 6MV-14, 6MV-17, 6MV-19	
2820VP	
SC150NGV	



Juego de herramientas para electricista, 28 herramientas



3049-2

180 x 435 x 270 mm	1	3049-2

268	
5470-140	
111M-7, 111M-8, 111M-10, 111M-13	
2744	
2427 S-200	IEC60900 1000V
8045LVDE	
BE-9765	
2705R	
481-300	
9072 P	
2628 S-180	IEC60900 1000V
2101S-160	
BE-8820S	
BE-8220S, BE-8040S, BE-8050S	
BE-8610S, BE-8620S	
BE-8255S	
B146.006.100	
4750-FOLTC-1	

Juego de 11 herramientas aisladas 11 piezas



7811DMV

11	270 x 79 x 350 mm	1 7811DMV

7800DMV-13, 7800DMV-10, 7800DMV-11, 7800DMV-22, 7800DMV-17, 7800DMV-19, 7800DMV-20	
8150-1/2V	
8154-1/2V	
8160-1/2V	
BE-8050S	

Maleta de cuero con 16 herramientas para electricista



982000170

290 x 195 x 440 mm	1	982000170

Dotación: TS100

4750-FOLTC-1	
2101GC-160IP	
2800 N	
6224 GC	
2630GC-160IP	
2421GC-160	
2521GC-160	
8071 C IP	
B196.065.150, B196.055.125, B196.030.100, B196.040.100	
B197.002.100, B197.001.080	
SC127	
2820EF2	
MTB-3-16	

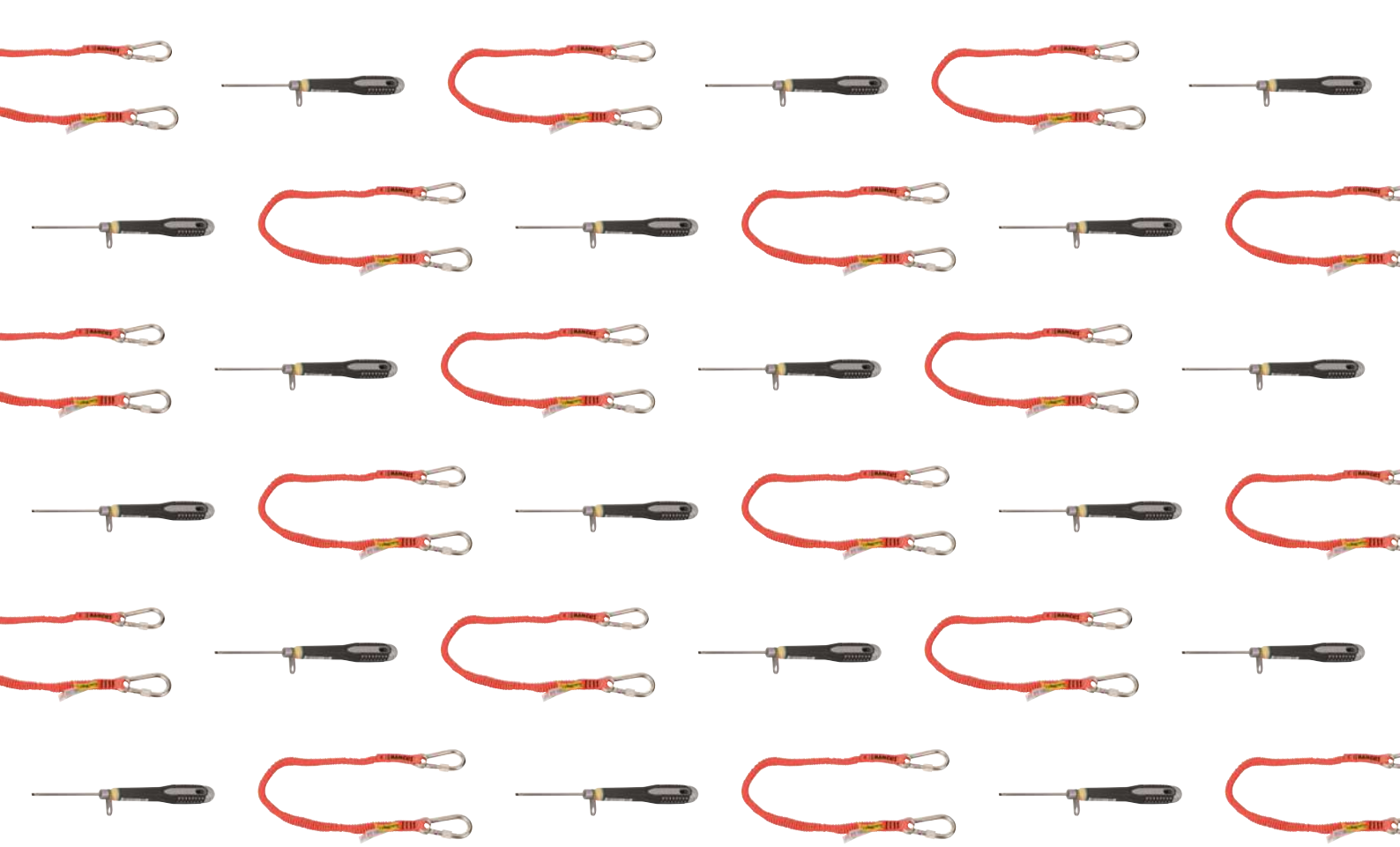

Herramientas para trabajos en altura



ALMACENAMIENTO DE HERRAMIENTAS Y CORDONES

Cordón con mosquetón 80cm para máx 3kg



3875-LY1



170



8 3875-LY1

Longitud máx.: 120cm

Cuerda de seguridad flexible con mosquetón fijo (3daN)



3875-LY2



120



8 3875-LY2

Largura 80cm, máx 120cm

Cordón flexible máx 1kg largo 65cm



3875-LY3



125



8 3875-LY3

Longitud máx.: 120cm

Lanyard para 3 Kg



3875-LY4



180



8 3875-LY4

Lanyard para 1Kg con mosquetones fijos
Según normativa DROPS



3875-LY5



80



1 3875-LY5



Cordón para muñecas (1daN) 60cm



3875-WL1



40



8 3875-WL1

Cordón conector para 3875-LY3 o 3875-WL1



3875-QL1



40



8 3875-QL1

Porta herramientas hast 25kg



439000000



100



1 439000000

Cordón conector para 3875-RL1



3875-QRL1



40



1 3875-QRL1

Lanyard espiral 1.7mm



439000001



130



1 439000001

Cordón flexible máx 0.9Kg



3875-RL1



200



1 3875-RL1

Longitud máx 100cm

Lanyard para 1Kg con mosquetones giratorios
Según normativa DROPS



3875-LY6



100



1 3875-LY6



Lanyard para 6Kg con mosquetones fijos
Según normativa DROPS



3875-LY8

330	1	3875-LY8



Lanyard para 2Kg con mosquetones giratorios
Según normativa DROPS



439000002

130	1	439000002



Lanyard corto para 1Kg con mosquetones fijos
Según normativa DROPS



3875-LY9

90	1	3875-LY9



Lanyard para 3Kg con mosquetones giratorios
Según normativa DROPS



439000003

160	1	439000003



Lanyard para 12Kg con mosquetones fijos
Según normativa DROPS



3875-LY10

270	1	3875-LY10



Bolsa colgante para 30 y 60 litros
Según normativa DROPS



3875-HB30/3875-HB60

270 x 270 x 350 mm	1	3875-HB30
350 x 350 x 640 mm	1	3875-HB60



Lanyard para 1Kg retráctil



3875-RL2

212	1	3875-RL2



Bolsa 100 l. para trabajos en altura
Según normativa DROPS



3875-HB100

400 x 400 x 900 mm	1	3875-HB100

Bolsa para trabajos en altura, 10 litros, carga máxima de 1Kg



3875-HB10

270 x 230 x 230 mm	1	3875-HB10

Bolsa para maleta rígida
Según normativa DROPS



3875-SB70

300 x 500 x 730 mm	1	3875-SB70



Bolsa con 4 ganchos
Según normativa DROPS



MHP4



70 x 200 x 400 mm



1 3875-MHP4

Porta taladros para diestros y zurdos
Según normativa DROPS



DHO-4



300 x 150 x 270 mm



1 4750-DHO-4

Cinturón de cuero resistente
Según normativa DROPS



4750-HDLB-TAH



50 x 120 x 460 mm



1 4750-HDLB-TAH



Bolsa con 6 ganchos
Según normativa DROPS



MHP6



10 x 200 x 380 mm



1 3875-MHP6

Bolsa universal
Según normativa DROPS



UP-2



300 x 150 x 300 mm



1 4750-UP-2

Mochila pequeña
Según normativa DROPS



3875-BP1



100 x 300 x 400 mm



8 3875-BP1



Jgo de cinturón con 3 bolsas
Según normativa DROPS



3PB-2



100 x 380 x 630 mm



1 4750-3PB-2

Soporte para martillo
Según normativa DROPS



4750-HHO-2



120 x 70 x 180 mm



1 4750-HHO-2

Mochila grande con múltiples compartimentos
Según normativa DROPS



3875-BP2



210 x 330 x 450 mm



8 3875-BP2



BAHCO

LLAVES

Llave ajustable serie 80
Según normativa DROPS



80TAH

L			
155mm/6"	20	1	TAH8070
205mm/8"	27	1	TAH8071
255mm/10"	31	1	TAH8072
305mm/12"	34	1	TAH8073
380mm/15"	44	1	TAH8074
460mm/18"	53	1	TAH8075

Llave ajustable serie 90
Según normativa DROPS

ergo



90TAH

L			
158mm/6"	20	1	TAH9070
250mm/10"	31	1	TAH9072

Llave Podger con anilla de seguridad
Según normativa DROPS



TAH84

L			
405mm/16"	41	1	TAH84-PODGER

Llave combinada con muelle de seguridad
Según normativa DROPS



TAH111M

L			
6 mm	112	1	TAH111M-6
85 mm	780	1	TAH111M-85

L			
7 mm	120	1	TAH111M-7
8 mm	130	1	TAH111M-8
9 mm	136	1	TAH111M-9
10 mm	144	1	TAH111M-10
11 mm	153	1	TAH111M-11
12 mm	160	1	TAH111M-12
13 mm	165	1	TAH111M-13
14 mm	177	1	TAH111M-14
15 mm	185	1	TAH111M-15
16 mm	195	1	TAH111M-16
17 mm	200	1	TAH111M-17
18 mm	208	1	TAH111M-18
19 mm	215	1	TAH111M-19
20 mm	240	1	TAH111M-20
21 mm	250	1	TAH111M-21
22 mm	250	1	TAH111M-22
23 mm	270	1	TAH111M-23
24 mm	270	1	TAH111M-24
25 mm	290	1	TAH111M-25
27 mm	310	1	TAH111M-27
30 mm	330	1	TAH111M-30
32 mm	345	1	TAH111M-32
34 mm	347	1	TAH111M-34
36 mm	400	1	TAH111M-36
41 mm	438	1	TAH111M-41
46 mm	500	1	TAH111M-46
50 mm	540	1	TAH111M-50
55 mm	560	1	TAH111M-55

Llave combinada en pulgadas con muelle de seguridad



TAH111Z

L			
1/4 in	112	1	TAH111Z-1/4
5/16 in	130	1	TAH111Z-5/16
3/8 in	140	1	TAH111Z-3/8
7/16 in	153	1	TAH111Z-7/16
1/2 in	169	1	TAH111Z-1/2
9/16 in	177	1	TAH111Z-9/16
5/8 mm	195	1	TAH111Z-5/8
11/16 mm	200	1	TAH111Z-11/16
3/4 in	218	1	TAH111Z-3/4
13/16 mm	250	1	TAH111Z-13/16
7/8 mm	250	1	TAH111Z-7/8
15/16 mm	270	1	TAH111Z-15/16
1 in	290	1	TAH111Z-1
1-1/16 mm	310	1	TAH111Z-1.1/16
1-1/8 mm	310	1	TAH111Z-1.1/8
1-1/4 mm	350	1	TAH111Z-1.1/4
1-5/16 mm	350	1	TAH111Z-1.5/16

Llave para racores con muelle de seguridad
Según normativa DROPS



TAH1949M

L			
8x9 mm	140	1	TAH1949M-8-9
10x11 mm	150	1	TAH1949M-10-11
12x14 mm	170	1	TAH1949M-12-14
14x17 mm	200	1	TAH1949M-14-17
19x22 mm	220	1	TAH1949M-19-22
24x27 mm	255	1	TAH1949M-24-27

Llave de impacto boca estrella con argolla
Según normativa DROPS



TAH7444SG

L			
36 mm	205	1	TAH7444SG-M-36
41 mm	230	1	TAH7444SG-M-41
46 mm	240	1	TAH7444SG-M-46
50 mm	255	1	TAH7444SG-M-50
55 mm	270	1	TAH7444SG-M-55

Llave combinada con carraca con muelle de seguridad
Según norma DROPS



TAH1RM

L			
17 mm	226	1	TAH1RM-17
19 mm	248	1	TAH1RM-19
24 mm	323	1	TAH1RM-24
30 mm	400	1	TAH1RM-30



Llave fija, mm., con muelle de seguridad
Según norma DROPS



TAH6M

Wrench Size	Length (mm)	Quantity	Part Number
14x15 mm	183	1	TAH6M-14-15
16x17 mm	201	1	TAH6M-16-17
18x19 mm	222	1	TAH6M-18-19
20x22 mm	225	1	TAH6M-20-22
24x27 mm	260	1	TAH6M-24-27
30x32 mm	300	1	TAH6M-30-32
8x9 mm	135	1	TAH6M-8-9
10x11 mm	153	1	TAH6M-10-11
12x13 mm	164	1	TAH6M-12-13
17x19 mm	222	1	TAH6M-17-19

Llave universal 5 en 1 con cuerda dyneema para trabajos en altura



TAHMK5

Wrench Size	Quantity	Part Number
97x25 mm	1	TAHMK5

LLAVES PARA TUBOS

Llave Stillson de aluminio con anilla
Según normativa DROPS



TAH380

Wrench Size	Length (mm)	Quantity	Part Number
253	1.1/2 in	1	TAH380-10
354	2 in	1	TAH380-14
455	2.1/2 in	1	TAH380-18
607	3 in	1	TAH380-24

Llave de tubo modelo sueco de 90°, con lazo de seguridad
Para trabajos en altura



TAH14

Wrench Size	Length (mm)	Quantity	Part Number
210	3/4 in	1	TAH140
320	1 in	1	TAH141
426	1 1/2 in	1	TAH142
557	2-1/2 in	1	TAH143

Llave de tubo modelo sueco de 90°, con lazo de seguridad
Para trabajos en altura



TAH1410-TAH1420

Wrench Size	Length (mm)	Quantity	Part Number
320	1 in	1	TAH1410
430	1 1/2 in	1	TAH1420

VASOS Y CARRACAS

Vasos hex 1/4" con solución en 4 puntos
Según normativa DROPS



TAH08

Nut Size	Quantity	Part Number
5.5 mm	1	TAH08-5.5
6 mm	1	TAH08-6
7 mm	1	TAH08-7
8 mm	1	TAH08-8
9 mm	1	TAH08-9
10 mm	1	TAH08-10
11 mm	1	TAH08-11
12 mm	1	TAH08-12
13 mm	1	TAH08-13

Mango articulado 1/4" con muelle de seguridad
Según normativa DROPS



TAH6958B-1

Handle Length	Quantity	Part Number
150 mm	1	TAH6958B-1

Alargadera 1/4" con solución en 4 puntos
Según normativa DROPS



TAH6960-TAH6962L

Extension Length	Quantity	Part Number
50 mm	1	TAH6960
101 mm	1	TAH6961
152 mm	1	TAH6962
355 mm	1	TAH6962L

Articulación universal 1/4" con solución en 4 puntos
Según normativa DROPS



TAH6966

Articulation Length	Quantity	Part Number
36 mm	1	TAH6966

Vasos 1/4" punta hexagonal con solución en 4 puntos
Según normativa DROPS



TAH08-H

3 mm	1	TAH08-H3
4 mm	1	TAH08-H4
5 mm	1	TAH08-H5
6 mm	1	TAH08-H6
8 mm	1	TAH08-H8

Vasos 1/4" para punta PH con solución en 4 puntos
Según normativa DROPS



TAH08-PH

1	1	TAH08-PH1
2	1	TAH08-PH2
3	1	TAH08-PH3

Vasos 1/4" para punta TORX® con solución en 4 puntos
Según normativa DROPS



TAH08TTAH

T-8	1	TAH08-T8
T-9	1	TAH08-T9
T-10	1	TAH08-T10
T-15	1	TAH08-T15
T-20	1	TAH08-T20
T-25	1	TAH08-T25
T-27	1	TAH08-T27
T-30	1	TAH08-T30
T-40	1	TAH08-T40

Carraca 1/4", 72 dientes/5° ángulo de acción, con cuerda Dyneema
Según normativa DROPS



TAH6950

120 mm	1	TAH6950

Portavasos 1/4" con cuello de seguridad
Según normativa DROPS



TAH6956-1TAH

150 mm	1	TAH6956-1

Vasos bihex. 1/2" con solución en 4 puntos
Según normativa DROPS



TAH16B

10 mm	1	TAH16B-10
11 mm	1	TAH16B-11
12 mm	1	TAH16B-12
13 mm	1	TAH16B-13
14 mm	1	TAH16B-14
15 mm	1	TAH16B-15
16 mm	1	TAH16B-16
17 mm	1	TAH16B-17
18 mm	1	TAH16B-18
19 mm	1	TAH16B-19
21 mm	1	TAH16B-21
22 mm	1	TAH16B-22
24 mm	1	TAH16B-24
25 mm	1	TAH16B-25
27 mm	1	TAH16B-27
30 mm	1	TAH16B-30
32 mm	1	TAH16B-32

Vaso bihex. 1/2" con solución en cuatro puntos
Según normativa DROPS



TAH16B"

1 in	1	TAH16B-1
1/2 in	1	TAH16B-1/2
11/16 in	1	TAH16B-11/16
13/16 in	1	TAH16B-13/16
9/16 in	1	TAH16B-9/16
5/8 in	1	TAH16B-5/8
3/4 in	1	TAH16B-3/4
7/8 in	1	TAH16B-7/8
15/16 in	1	TAH16B-15/16
1 1/16 in	1	TAH16B-1.1/16
1 1/8 in	1	TAH16B-1.1/8
1 1/4 in	1	TAH16B-1.1/4

Mango articulado 1/2" con muelle de seguridad
Según normativa DROPS



TAH8158B-1

256 mm	1	TAH8158B-1

Alargadera 1/2" con solución en cuatro puntos
Según normativa DROPS



TAH8160-8162

125 mm	1	TAH8160
250 mm	1	TAH8162



Junta universal 1/2" con solución en cuatro puntos
Según normativa DROPS



TAH8166

67 mm	1 TAH8166

Vaso con punta 1/2" hex. con solución en cuatro puntos
Según normativa DROPS



TAH16H

4 mm	1 TAH16-H4
5 mm	1 TAH16-H5
6 mm	1 TAH16-H6
7 mm	1 TAH16-H7
8 mm	1 TAH16-H8
10 mm	1 TAH16-H10
12 mm	1 TAH16-H12
14 mm	1 TAH16-H14
17 mm	1 TAH16-H17
19 mm	1 TAH16-H19

Vasos con punta 1/2" hex. con solución en cuatro puntos
Según normativa DROPS



TAH16H

1/4	1 TAH16H-1/4
5/16	1 TAH16H-5/16
3/8	1 TAH16H-3/8
7/16	1 TAH16H-7/16
1/2	1 TAH16H-1/2
5/8	1 TAH16H-5/8
9/16	1 TAH16H-9/16

Vasos con punta 1/2" TORX® con solución en cuatro puntos
Según normativa DROPS



TAH16-T

T30	1 TAH16-T30
T40	1 TAH16-T40
T45	1 TAH16-T45
T50	1 TAH16-T50
T55	1 TAH16-T55
T60	1 TAH16-T60

Carraca reversible 1/2" - 80 dientes/ 4.5° ángulo de acción, con cuerda Dyneema
Según normativa DROPS



TAH8150-1/2

270 mm	1 TAH8150-1/2

Vasos bihex. 3/4" con solución de 4 puntos
Según normativa DROPS



TAH24B

27 mm	1 TAH24B-27
30 mm	1 TAH24B-30
32 mm	1 TAH24B-32
36 mm	1 TAH24B-36
38 mm	1 TAH24B-38
41 mm	1 TAH24B-41
46 mm	1 TAH24B-46
50 mm	1 TAH24B-50

Alargaderas 3/4" con 4 puntos
Según normativa DROPS



TAH8961

200 mm	1 TAH8961

Mango universal 3/4" con cuerda de alambre
Según normativa DROPS



TAH8953

500 mm	1 TAH8953

Cabeza de carraca reversible 3/4", con cuerda de alambre
Según normativa DROPS



TAH8950N/A

170 mm	1 TAH8950N/A

Llave de chicharra equipada con un anillo de seguridad para 13 a 22 tamaños
Para trabajos en altura



TAHSC2RM

13-17 mm	280	1 TAHSC2RM-13-17
15-17 mm	280	1 TAHSC2RM-15-17
19-22 mm	310	1 TAHSC2RM-19-22
27-30 mm	450	1 TAHSC2RM-27-30

DESTORNILLADORES

Destornillador ERGO™ boca recta con placa de inserción
Según normativa DROPS

ergo®



TAHBE8020L-TAHBE8252



3.2 mm	75	1	TAHBE-8020L
3.5 mm	75	1	TAHBE-8030
4 mm	100	1	TAHBE-8040
5.5 mm	150	1	TAHBE-8241
6.5 mm	150	1	TAHBE-8252

Destornillador ERGO™ boca plana con cuerda Dyneema
Según normativa DROPS

ergo®



TAHBE8155



6 mm	125	1	TAHBE-8155
8 mm	175	1	TAHBE-8257
8 mm	210	1	TAHBE-8258

Destornillador ERGO™ boca plana con cuerda Dyneema
Según normativa DROPS

ergo®



TAHBE-8260



9 mm	175	1	TAHBE-8260
------	-----	---	------------

Destornillador stubby ERGO™ boca recta con cuello de seguridad
Según normativa DROPS

ergo®



TAHBE-8350



5.5 mm	28	1	TAHBE-8350
--------	----	---	------------

Destornilladores ERGO™ PH con cuello de seguridad
Según normativa DROPS

ergo®



TAHBE8610-TAHBE8624



PH 1	75 mm	1	TAHBE-8610
PH 1	75 mm	1	TAHBE-8611
PH 2	100 mm	1	TAHBE-8620
PH 2	200 mm	1	TAHBE-8620L
PH 3	150 mm	1	TAHBE-8623
PH 4	190 mm	1	TAHBE-8624

Destornilladores ERGO™ PH con cuerda Dyneema
Según normativa DROPS

ergo®



TAHBE-8630



PH 3	155 mm	1	TAHBE-8630
------	--------	---	------------

Destornilladores stubby ERGO™ PH con cuello de seguridad
Según normativa DROPS

ergo®



TAHBE-8602



PH 2	30 mm	1	TAHBE-8602
------	-------	---	------------

Destornilladores ERGO™ PZ con cuello de seguridad
Según normativa DROPS

ergo®



TAHBE8810-TAHBE8820



PZ 1	73 mm	1	TAHBE-8810
PZ 2	100 mm	1	TAHBE-8820

Destornilladores ERGO™ PZ varilla hexagonal con cuerda Dyneema
Según normativa DROPS

ergo®



TAHBE-8830



PZ 3	150 mm	1	TAHBE-8830
------	--------	---	------------



Destornillador ERGO™ para tornillos TORX® con placa de inserción
Para tornillos TORX®



TAHBE8910-TAHBE8930



T10	2.72 mm	1	TAHBE-8910
T15	3.26 mm	1	TAHBE-8915
T20	3.84 mm	1	TAHBE-8920
T25	4 mm	1	TAHBE-8925
T30	6 mm	1	TAHBE-8930

Destornillador ERGO™ aislado para tornillos TORX®
Para trabajos en altura



TAHBE8910S-TAHBE8930S



T10	2.5 mm	1	TAHBE-8910S
T15	3.26 mm	1	TAHBE-8915S
T20	3.84 mm	1	TAHBE-8920S
T25	4.4 mm	1	TAHBE-8925S
T30	5.49 mm	1	TAHBE-8930S

Llave acodada doble con alambre de acero
Según normativa DROPS



TAH2047-0.8-4

4.0 mm	1 TAH2047-0.8-4

Destornilladores aislado ERGO™ boca plana con cuerda Kevlar
Según normativa DROPS



TAHBE8040S-TAHBE8050S



4.0 mm	100 mm	1	TAHBE-8040S
5.5 mm	125 mm	1	TAHBE-8050S
3.0 mm	100 mm	1	TAHBE-8220S
6.5 mm	155 mm	1	TAHBE-8255S

Juego 7 llaves allen hex., métricas, en cuerda Kevlar
Según normativa DROPS



TAHBE-9777B



2.5,3,4,5,6,8,10 mm	1	TAHBE-9777B

Llave acodada para tornillos PH con alambre de acero
Según normativa DROPS



TAH2047PR-1-2

PH 1 & 2	1 TAH2047PR-1-2

Destornilladores aislados ERGO™ PH con cuerda Kevlar
Para trabajos en altura



TAHBE8610S-TAHBE8620S



PH1	80 mm	1	TAHBE-8610S
PH2	100 mm	1	TAHBE-8620S
PH3	150 mm	1	TAHBE-8630S
PH4	190 mm	1	TAHBE-8640S

Juego 7 llaves allen hex., pulgadas, con placa de inserción
Según normativa DROPS



TAHBE-9787



3/32, 1/8, 5/32, 3/16, 1/4, 5/16, 3/8 mm	1	TAHBE-9787

Liberador de pin para vasos TAH
Según normativa DROPS



TAHPINRELEASER

4 45	1 TAHPINRELEASER

ALICATES

Alicate diagonal con anilla de seguridad
Según normativa DROPS

ergo®



TAH2101G



130	1 TAH2101G-125
125	1 TAH2101G-125C
145	1 TAH2101G-140C
165	1 TAH2101G-160C
185	1 TAH2101G-180
180	1 TAH2101G-180C
145	1 TAH2101G-140
165	1 TAH2101G-160

Alicate cortante "Heavy Duty" con anilla de seguridad
Para trabajos en altura

ergo®



TAH21HDG



210	1 TAH21HDG-200
200	1 TAH21HDG-200C

Alicate boca semirredonda plana con anilla de seguridad
Según normativa DROPS

ergo®



TAH2430G



200	1 TAH2430G-200
-----	----------------

Alicate boca semirredonda curvado con anilla de seguridad
Según normativa DROPS

ergo®



TAH2427G



200	1 TAH2427G-200
-----	----------------

Alicates universales con anilla de seguridad
Según normativa DROPS

ergo®



TAH2628G



170	1 TAH2628G-160
190	1 TAH2628G-180

Alicate de apertura múltiple con anillo de seguridad
Para trabajos en altura



TAH2970G



200	1 TAH2970G-200
-----	----------------

Tenacilla articulada ERGO™ con anilla de seguridad
Según normativa DROPS

ergo®



TAH8224



250	1 TAH8224
-----	-----------

Alicate pelacables para trabajos en altura



TAH2223G-150



1 TAH2223G-150

Grip universal mordazas curvadas para trabajos en altura



TAH2951



1 TAH2951-250



Mordaza grip boca recta con placa de inserción
Según normativa DROPS



TAH2958



200 1 TAH2958-200
245 1 TAH2958-250

Arco de sierra tradicional con cable de alambre
Según normativa DROPS



TAH320



500 1 TAH320

Lima media caña con anilla de seguridad
Según normativa DROPS

ergo®



TAH1-210



270 2 1 TAH1-210-06-2-2

Alicate trenzador con anilla de seguridad
Según normativa DROPS



TAH2855



232 1 TAH2855

Arco de sierra con cable de alambre
Según normativa DROPS



TAH317



432 1 TAH317

Lima redonda con myril de seguridad
Según normativa DROPS

ergo®



TAH1-230



260 2 1 TAH1-230-06-2-2

HERRAMIENTAS DE CORTE

Arco de sierra con cable de alambre
Según normativa DROPS

ergo®



TAH325



300 1 TAH325

Arco de sierra de aluminio con cable de alambre
Según normativa DROPS



TAH225-PLUS



310 mm 1 TAH225-PLUS

Lima basta 2 cantos planos y anilla de seguridad
Según normativa DROPS

ergo®



TAH1-143



415 1 1 TAH1-143-12-1-2

Tijera de electricista con asa de alambre
Según normativa DROPS



TAHSCB140G

145	43 mm	1	TAHSCB140G

Navaja de electricista con cadena de Dyneema
Según normativa DROPS



TAH2820EF

200	65 mm	1	TAH2820EF2

Cepillo de uso general
Para trabajos en altura



TAH785-U & TAH52

150	1	TAH52
290	1	TAH782-U

MARTILLOS, PALANCAS Y CINCELES

Martillo anti-rebote con anilla de seguridad
Según normativa DROPS



TAH3625PU

620	340	1	TAH3625PU-50

Maza boca de nylon con cable de acero
Según normativa DROPS



TAH3625PW

300		1	TAH3625W-35

Martillo de bola con cable de acero
Según normativa DROPS



TAH479

480	350	1	TAH479-16
900	400	1	TAH479-32

Martillo tipo alemán DIN con cable de acero
Según normativa DROPS



TAH481

300	300	1	TAH481-300

Maceta con cable de acero
Según normativa DROPS



TAH484

1500	280	1	TAH484-1500
2000	305	1	TAH484-2000

Maza de seguridad con anilla
Según normativa DROPS



TAH489

1800	300	1	TAH489-1800
1100	294	1	TAH489-1100
2700	770	1	TAH489-2700
3600	770	1	TAH489-3600
5400	795	1	TAH489-5400



Piqueta con anilla de alambre
Según norma DROPS



TAH486F

700	330	1 TAH486F-700

Desenroscador con anilla de alambre
Según normativa DROPS



TAH4400

20 mm	725	1 TAH440007000

Barra desenroscadora para trabajos en altura



TAHWBB

1 TAHWBB600 1 TAHWBB700

Botador cilíndrico bi-material con placa de inserción
Según normativa DROPS



TAH3734BM

155 155 165	1 TAH3734BM-2 1 TAH3734BM-3 1 TAH3734BM-4

165 185 185 185	1 TAH3734BM-5 1 TAH3734BM-6 1 TAH3734BM-8 1 TAH3734BM-10

Granete bi-material con placa de inserción
Según normativa DROPS



TAH3755BM

155	1 TAH3755BM-4

Cortafíos plano con anilla de seguridad
Según normativa DROPS



TAH3640

250	25 mm	1 TAH3640-250-C

Palanca polivalente con anilla de seguridad
Según normativa DROPS



TAH2484

305 mm	1 TAH2484-30

Palanca especial 90° con argolla
Para trabajos en altura



TAH3683

400 mm	1 TAH3683

MEDICIÓN Y TRAZADO

Nivel andamio con cuerda
Según normativa DROPS



TAH466

250	1 TAH466-250

Calibre con anilla de seguridad
Según normativa DROPS



TAH1150

7 x 75 x 235 mm	1 TAH1150-1/2H/P

Punta de trazar con cuerda de alambre
Según normativa DROPS



TAH1177

30	1 TAH1177-SCRIBE

Galgas profesionales con anilla de seguridad
Según normativa DROPS



TAH1544



105 mm



1 TAH1544

Escuadra combinada equipado con dyneema para
Trabajar en Altura



TAHCS300



300 mm



125 mm



1 TAHCS300

HERRAMIENTAS DINAMOMÉTRICAS

Llave dinamométrica reversible mango de metal con
escala con anillo de alambre
Para trabajos en altura - Pin de seguridad



TAH7445



20-100 Nm



1/2" mm



1 TAH7445-100A-1

Dedo flexible con cuerda de alambre
Según normativa DROPS



TAH2509



560 mm



1 TAH2509

Escuadra equipada con dyneema para Trabajos en
Altura



TAH9048-250



250 mm



165 mm



1 TAH9048-250

Llave dinamométrica con anillo de alambre
Según normativa DROPS



TAH7455



60-300 Nm



44.3-221.3 lb-ft



1 TAH7455-300-1

Extractor magnético con cuerda
Según normativa DROPS

ergo®



TAH2535F2



13 mm



405 mm



1 TAH2535F2

Escuadra equipada con dyneema para Trabajos en
Altura
Acabado negro



TAH9045-B-250



250 mm



170 mm



1 TAH9045-B-250

Llave dinamométrica de escala con cabeza
intercambiable, mango de plástico, con cuerda de
alambre. Para trabajos en altura



TAH7435



20-100 Nm



9x12 mm



1 TAH7435-100



Cabeza de carraca reversible con dispositivo de bloqueo
Según normativa DROPS



TAH7452-2



12X9 mm	1/2"	1	TAH7452-2

HERRAMIENTAS DE SUJECCIÓN

Mordaza mango de plástico con grillete de seguridad para Trabajos en Altura



TAH420SH-80-160



160	80 mm	1	TAH420SH-80-160

OTRAS HERRAMIENTAS

Llave de filtro de cadena
Según normativa DROPS



TAHBE64520



520 mm	60-160 mm	1	TAHBE64520

Lámpara frontal con cuerda
Según normativa DROPS



TAHBFRL11



BAHCO

90 x 95 x 115 mm	1	TAHBFRL11

Rasqueta de carbono con muelle de seguridad
Según normativa DROPS



TAH2487



205 mm	1	TAH2487

Bomba de grasa de acoplamiento rápido
Para trabajos en altura



TAHBOD54

120 x 385 x 57 mm	1	TAHBOD5400
135 x 400 x 61 mm	1	TAHBOD5450

GUANTES

Guantes de trabajo multiusos



GL008

10	5	GL008-10
8	5	GL008-8

Guantes multi-usos



3875-GLOVE

5	3875-GLOVE

Guantes para herramienta de impacto



GL010

10	5	GL010-10
8	5	GL010-8

Guantes de carpintero



GL012

10	6	GL012-10
8	5	GL012-8



Herramientas aisladas



DESTORNILLADORES

Destornillador ERGO™ aislado punta plana 1000 V

ergo



IEC60900 1000V

BE-8010S - BE-8065S



2.5	75	5	BE-8010S
3.0	100	5	BE-8220S
3.5	100	5	BE-8230S
4.0	100	5	BE-8040S
5.5	125	5	BE-8050S
6.5	150	5	BE-8255S
8.0	175	5	BE-8065S
10	200	5	BE-8258S
12	200	5	BE-8259S

Destornillador aislado ERGO™ punta Phillips 1000 V

ergo



IEC60900 1000V

BE-8600S - BE-8640S

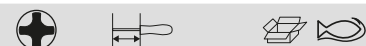

PH 0	75	5	BE-8600S
PH 1	80	5	BE-8610S
PH 1	150	5	BE-8612S
PH 2	100	5	BE-8620S
PH 2	100	5	BE-8621S
PH 2	175	5	BE-8622S
PH 3	150	5	BE-8630S
PH 4	200	5	BE-8640S

Destornilladores ERGO™ aislados punta Pozidriv 1000 V

ergo



IEC60900 1000V

BE-8800S - BE-8840S

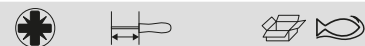

PZ 0	75	5	BE-8800S
PZ 1	80	5	BE-8810S
PZ 1	150	5	BE-8812S
PZ 2	100	5	BE-8820S
PZ 2	100	5	BE-8821S
PZ 2	175	5	BE-8822S
PZ 3	150	5	BE-8830S
PZ 4	200	5	BE-8840S

Destornillador ERGO™ aislado para tornillos TORX® 1000 V

ergo



IEC60900 1000V

BE-8910S - BE-8930S



T 5	75	5	BE-8905S
T 6	75	5	BE-8906S
T 7	75	5	BE-8907S
T 8	75	5	BE-8908S
T 9	75	5	BE-8909S
T 10	100	5	BE-8910S
T 15	125	5	BE-8915S
T 20	125	5	BE-8920S
T 25	150	5	BE-8925S
T 30	175	5	BE-8930S

Destornillador ERGO™ aislado hexagonal Para tornillos hexagonales

ergo



IEC60900 1000V

BE-8725S - BE-8708S

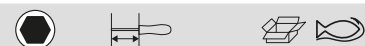

2.5	100	5	BE-8725S
3	125	5	BE-8703S
4	150	5	BE-8704S
5	175	5	BE-8705S
6	150	5	BE-8706S
8	200	5	BE-8708S

Destornilladore ERGO™ aislados puntas combi Ranurados 5 y 6, y Phillips PH1 y 2

ergo



IEC60900 1000V

BE-8510S - BE-8520S

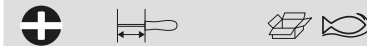

5.0/PH1	80	5	BE-8510S
6.0/PH2	100	5	BE-8520S

Destornilladores ERGO™ aislados puntas combi Ranurados: 5 y 6 y Pozidriv 1 y 2

ergo



IEC60900 1000V

BE-8710S - BE-8720S



5.0/PZ1	80	5	BE-8710S
6.0/PZ2	100	5	BE-8720S

Destornilladores ERGO™ aislados con aislamiento integrado Para tornillos de cabeza plana

ergo



IEC60900 1000V

BE-8220SL - BE-8255SL



3.0	100	10	BE-8220SL
3.5	100	10	BE-8230SL
4.0	100	10	BE-8040SL
5.5	125	10	BE-8050SL
6.5	150	10	BE-8255SL

Destornilladores ERGO™ aislados PH con aislamiento integrado
Para tornillos Phillips



BE-8610SL - BE-8620SL

	80	10	BE-8610SL
	100	10	BE-8620SL

Destornilladores ERGO™ aislados punta COMBI PL/ PH con aislamiento integrado
Para tornillos combi ranurados/ Phillips



BE-8510SL - BE-8520SL

	80	10	BE-8510SL
	100	10	BE-8520SL

Juego 2 destornilladores ERGO™ aislados varilla integrada
Para tornillos Phillips



BE-9891SL

		1	BE-9891SL
2			

BE-8610SL, BE-8620SL

Destornilladores ERGO™ aislados PZ con aislamiento integrado
Para tornillos Pozidriv



BE-8810SL - BE-8820SL

	80	10	BE-8810SL
	100	10	BE-8820SL

Destornilladores ERGO™ aislados punta COMBI PL/ PZ con aislamiento integrado
Para tornillos combi ranurados/ Pozidriv



BE-8710SL - BE-8720SL

	80	10	BE-8710SL
	100	10	BE-8720SL

Juego 2 destornilladores ERGO™ aislados varilla integrada
Para tornillos Pozidriv



BE-9894SL

			1	BE-9894SL
2	132			

BE-8810SL, BE-8820SL

Destornilladores ERGO™ aislados TORX con aislamiento integrado
Para tornillos TORX®



BE-8910SL - BE-8930SL

	100	5	BE-8910SL
	100	5	BE-8915SL
	100	5	BE-8920SL
	125	5	BE-8925SL
	150	5	BE-8930SL

Juego 2 destornilladores ERGO™ aislados varilla integrada



BE-9890SL

			1	BE-9890SL
2	175			

Juego 4 destornilladores ERGO™ aislados con varilla integrada
Para tornillos TORX®



BE-9880SL

		1	BE-9880SL
4			

BE-8910SL, BE-8915SL, BE-8920SL, BE-8925SL



Juego 5 destornilladores ERGO™ aislados con varilla integrada
Para tornillos de cabeza plana y Phillips



BE-9881SL



5

1 BE-9881SL

BE-8220SL, BE-8040SL, BE-8050SL



BE-8610SL, BE-8620SL



Juego 5 destornilladores ERGO™ aislados con varilla integrada
Para tornillos de cabeza plana y Pozidriv



BE-9882SL



5

1 BE-9882SL

BE-8220SL, BE-8040SL, BE-8050SL



BE-8810SL, BE-8820SL



Destornillador stecker aislado ERGO™



BE-7855S -BE-7810S

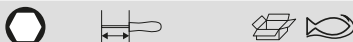

5.5	125	5	BE-7855S
6	125	5	BE-7806S
7	125	5	BE-7807S
8	125	5	BE-7808S
9	125	5	BE-7809S
10	125	5	BE-7810S

Juego 12 destornilladores ERGO™ aislados
Para tornillos ranurados, Phillips, Pozidriv, TORX® y Combi PH



BE-9878SL



12

1 BE-9878SL

BE-8010S



BE-8220SL, BE-8230SL, BE-8040SL,
BE-8050SL



BE-8610SL, BE-8620SL



BE-8810SL, BE-8820SL



BE-8510SL, BE-8520SL



BE-8910SL



Juego 5 destornilladores ERGO™ aislados
Plana: 0.5-0.8-1 y Phillips 1 & 2



BE-9881S



5

1 BE-9881S

BE-8220S, BE-8040S, BE-8050S



BE-8610S, BE-8620S



Juego 5 destornilladores ERGO™ aislados
Plana: 0.5-0.8-1 y Pozidriv 1 y 2



BE-9882S



5

1 BE-9882S

BE-8220S, BE-8050S, BE-8040S



BE-8810S, BE-8820S



Juego 7 destornilladores ERGO™ aislados
Plana: 0.4-0.5-0.8-1 y Pozidriv 0&2&3



BE-9888S



7

1 BE-9888S

BE-8040S, BE-8050S, BE-8010S,
BE-8220S



BE-8800S, BE-8820S, BE-8830S



Juego 4 destornilladores ERGO™ aislados
Ranuras/PH y Ranurados/PZ



BE-9885S



5

1 BE-9885S

806-1-1



BE-8520S, BE-8510S



BE-8710S, BE-8720S



Juego 6 destornilladores ERGO™ aislados y
comprobador de tensión
4 planos y 2 Phillips + Comprobador



BE-9887S



7

1 BE-9887S

806-1-1

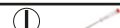

BE-8010S, BE-8050S, BE-8230S,
BE-8040S



BE-8610S, BE-8621S



Juego 6 destornilladores ERGO™ aislados y comprobador de tensión para tornillos planos y Pozidriv

ergo®



BE-9889S



7 1 BE-9889S

BE-8010S, BE-8040S, BE-8050S, BE-8230S



BE-8810S, BE-8821S



806-1-1



Juego 6 destornilladores ERGO™ aislados Para tornillos boca plana, Pozidriv, y puntas combi (Recta+PZ)

ergo®



BE-9884S



6 1 BE-9884S

BE-8220S, BE-8040S



BE-8710S, BE-8720S



BE-8810S, BE-8820S



Juego 2 destornilladores ERGO™ aislados

ergo®



BE-9890S



2 175 1 BE-9890S

Uso en cuadros eléctricos y terminales

BE-8710S, BE-8720S



Destornillador Aislo Boca Recta BahcoFit



B196



2.5	75	10	B196.025.075
3	100	10	B196.030.100
3.5	100	10	B196.035.100
4	100	10	B196.040.100
5.5	125	10	B196.055.125
6.5	150	10	B196.065.150
8	175	10	B196.080.175
10	200	10	B196.100.200
12	200	10	B196.120.200
2.5	75	1	SB196.025.075
3	100	1	SB196.030.100
3.5	100	1	SB196.035.100
4	100	1	SB196.040.100
5.5	125	1	SB196.055.125
6.5	150	1	SB196.065.150
8	175	1	SB196.080.175
10	200	1	SB196.100.200
12	200	1	SB196.120.200

SB: Presentación en clip

Destornillador Aislo PH BahcoFit



B197PH



PH0	75	10	B197.000.075
PH1	80	10	B197.001.080
PH1	150 mm	10	B197.001.150
PH2	100	10	B197.002.100
PH2	175 mm	10	B197.002.175
PH3	150	10	B197.003.150
PH4	200	10	B197.004.200
PH0	75	1	SB197.000.075
PH1	80	1	SB197.001.080
PH2	100	1	SB197.002.100
PH3	150	1	SB197.003.150
PH4	200	1	SB197.004.200

SB: Presentación en clip

Destornillador BahcoFit Aislo PZ



B142PZ



PZ0	75	10	B142.000.075
PZ1	80	10	B142.001.080
PZ1	150 mm	10	B142.001.150
PZ2	100	10	B142.002.100
PZ2	175 mm	10	B142.002.175
PZ3	150	10	B142.003.150
PZ0	75	1	SB142.000.075
PZ1	80	1	SB142.001.080
PZ2	100	1	SB142.002.100
PZ3	150	1	SB142.003.150

SB: Presentación en clip

Destornilladores aislados ERGO™ punta TORX®



B150TORX



T10	100 mm	10	B150.010.100
T15	125 mm	10	B150.015.125
T20	125 mm	10	B150.020.125
T25	150 mm	10	B150.025.150
T10	100 mm	1	SB150.010.100
T15	125 mm	1	SB150.015.125
T20	125 mm	1	SB150.020.125
T25	150 mm	1	SB150.025.150

Destornillador combi Phillips aislado Para uso en terminales eléctricas



B148



6.0mm/PH2	80 mm	10	B148.001.080
5.0mm/PH1	100 mm	10	B148.002.100
6.0mm/PH2	80 mm	1	SB148.001.080
6.0mm/PH2	100 mm	1	SB148.002.100



Destornillador BahcoFit Stecker Aislo



B199



Size	Length	Quantity	Part Number
5.5	125	5	B199.055.125
6	125	5	B199.060.125
7	125	5	B199.070.125
8	125	5	B199.080.125
9	125	5	B199.090.125
10	125	5	B199.100.125
11	125	5	B199.110.125
12	125	5	B199.120.125
13	125	5	B199.130.125
5.5	125	1	SB199.055.125
6	125	1	SB199.060.125
7	125	1	SB199.070.125
8	125	1	SB199.080.125
9	125	1	SB199.090.125
10	125	1	SB199.100.125
11	125	1	SB199.110.125
12	125	1	SB199.120.125
13	125	1	SB199.130.125

Destornillador combi Pozidriv aislado
Para uso en terminales eléctricas



B149



Size	Length	Quantity	Part Number
80 mm		10	B149.001.080
6.0mm/PZ2	100 mm	10	B149.002.100
5mm/PZ1	80 mm	1	SB149.001.080
6.0mm/PZ2	100 mm	1	SB149.002.100

Juego 2 destornilladores BahcoFit aislados
Para tornillos de cabeza plana y Phillips



B220.002



Quantity	Weight	Part Number
2	90	1 B220.002

B196.030.100

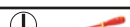

B197.001.080



Juego 2 destornilladores BahcoFit punta COMBI PL/
PZ
Para tornillos combi Pozidriv



B220.012



Quantity	Weight	Part Number
2	182	1 B220.012

B149.001.080, B149.002.100



Juego 5 destornilladores BahcoFit aislados PL/PH
Para tornillos ranurados y Phillips



B220.005



Quantity	Part Number
5	1 B220.005

B196.030.100, B196.040.100,
B196.055.125



B197.001.080, B197.002.100



Juego 5 destornilladores BahcoFit aislados PL/PZ
Para tornillos ranurados y Pozidriv



B220.015



Quantity	Part Number
5	1 B220.015

B196.035.100, B196.040.100,
B196.065.150



B142.001.080, B142.002.100



Juego 7 destornilladores BahcoFit aislados PL/PH
Para tornillos ranurados y Phillips



B220.007



Quantity	Part Number
7	1 B220.007

B196.030.100, B196.040.100,
B196.055.125, B196.065.150



B197.000.075, B197.001.080,
B197.002.100



Juego 7 destornilladores BahcoFit aislados PL/PZ
Para tornillos ranurados y Pozidriv



B220.017



Quantity	Part Number
7	1 B220.017

B196.025.075, B196.040.100,
B196.055.125, B196.065.150



B142.000.075, B142.001.080,
B142.002.100



Juego 7 destornilladores aislados BahcoFit PL/PH/TESTER
Para tornillos ranurados y Phillips



B220.027



7 1 B220.027

B196.030.100, B196.040.100,
B196.055.125



B197.000.075, B197.001.080,
B197.002.100



806-1-1



Destornillador Aislado boca Recta



623



3.0	100	10	623-3-100
3.5	100	10	623-3.5-100
4.0	100	10	623-4-100
5.5	125	10	623-5.5-125
6.5	150	10	623-6.5-150

Destornillador Boca Phillips aislado



625PH



PH 0	100	10	625-0-100
PH 1	150	10	625-1-150
PH 2	175	10	625-2-175

Juegostornillador a carraca con 6 varillas intercambiables 1000V



808061



7 85 x 85 x 218 mm 5 808061

Aislamiento integrado en varilla

808060



8610SL-2P, 8620SL-2P



8010SL-2P, 8040SL-2P, 8050SL-2P,
8220SL-2P



Juego de destornillador a carraca 1000V con 6 varillas intercambiables



808062



7 85 x 85 x 215 mm 5 808062

808060



8820SL-2P, 8810SL-2P



8010SL-2P, 8040SL-2P, 8050SL-2P,
8220SL-2P



Destornillador a carraca para varillas intercambiables 1000V con botón extracción de varillas muy seguro



808060



36 122 1 808060

Carraca 48 dientes

Pack de 2 varillas intercambiables con aislamiento integrado
Boca plana, 100mm



8010SL-2P - 8050SL-2P



0.4	2.5	1	8010SL-2P
0.5	3.0	1	8220SL-2P
0.8	4.0	1	8040SL-2P
1.0	5.5	1	8050SL-2P

Pack de 2 varillas intercambiables PH aisladas, 100mm
Para tornillos Phillips



8610SL-2P - 8620SL-2P



1	1	8610SL-2P
2	1	8620SL-2P

Pack de 2 varillas intercambiables PZ aisladas, 100mm
Para tornillos Pozidriv



8810SL-2P - 8820SL-2P



1	1	8810SL-2P
2	1	8820SL-2P



Varillas intercambiables aisladas con diámetro reducido para tornillos combi (Plano/PH), 100mm largo



IEC60900 1000V

8510SL-2P - 8520SL-2P

5.0	1	1	8510SL-2P
6.0	2	1	8520SL-2P

Pack de 2 varillas intercambiables Combi (recta-PZ) aisladas, 100mm



IEC60900 1000V

8710SL-2P - 8720SL-2P

5.0	1	1	8710SL-2P
6.0	2	1	8720SL-2P

Pack de 2 varillas intercambiables TORX® aisladas, 100mm



IEC60900 1000V

8910SL-2P - 8930SL-2P

10	1	8910SL-2P
15	1	8915SL-2P
20	1	8920SL-2P
25	1	8925SL-2P
30	1	8930SL-2P

ALICATES

Alicates corte lateral con filos progresivos de seguridad mangos aislados. Para alambre de piano y materiales más blandos como plástico o cobre



2101S

IEC60900 1000V

3.7	2.0	3	2101S-140
3.8	2.5	3	2101S-160
4.0	2.7	3	2101S-180

Alicate de corte diagonal aislado con filos progresivos Para alambre de piano y materiales más blandos como plástico o cobre



2101S-200

IEC60900 1000V

4.5	3.0	3	2101S-200

Cortacables aislado para Cu/Al 18mm



2260S

IEC60900 1000V

210	2	2260 S-210

Alicate cortacables de seguridad Para aluminio y cobre



2520S

IEC60900 1000V

552	1	2520 S

Alicate de seguridad corte lateral 1000V



2171V

IEC60900 1000V

2.7	160	2	2171V-160
2.8	180	2	2171V-180

Alicate extrafuerte de seguridad corte lateral Para alambre de piano



2191V

IEC60900 1000V

3.0	2	2	2191V-180
4.0	2.5	2	2191V-200

Alicate corte frontal de seguridad



527V

IEC60900

	L		
2	160	2	527V-160
2.5	200	2	527V-200

Alicate cortacables de seguridad



2250V

IEC60900

L			
170	0-10	2	2250V-170
230	0-15	2	2250V-230

Alicate cortacables de seguridad
Para cobre y aluminio



2260V

IEC60900

L			
210		2	2260V-210

Cortavarillas de seguridad 1000V
1000 V



2820VBC

IEC60900

L			
630		1	2820VBC

Alicate de corte lateral cromado plateado, 1000V
aislado
Para alambre de acero templado



2674 NVDE

IEC60900

Cu mm	Fierro mm			
3.7	2.0	1	2674 NVDE	

Alicates universales de seguridad mangos aislados



2628S

IEC60900

Fierro mm	Aluminio mm			
2.0	1.8	3	2628 S-160	
2.5	2.0	3	2628 S-180	
3.0	2.5	3	2628 S-200	

Alicate universal de seguridad



2678V

IEC60900

Cu mm	L			
2.7	160	2	2678V-160	
3.0	180	2	2678V-180	
4.0	200	2	2678V-200	

Alicate boca semirredonda de seguridad mangos
aislados
Para alambre de acero templado



2430S

IEC60900

Cu mm	Fierro mm			
3.0	1.8	3	2430 S-160	
3.0	1.8	3	2430 S-200	

Alicate boca semirredonda aislado con bocas
curvadas 45°



2427S

IEC60900

Cu mm	Fierro mm			
3.0	1.8	3	2427 S-200	



Alicate boca semirredonda de seguridad mangos aislados
Para alambre de acero templado



2430V

IEC60900 1000V

3.0	160	2	2430V-160
3.0	200	2	2430V-200

Alicate boca redonda de seguridad 1000V



2521V

IEC60900 1000V

160		2	2521V-160

Tenacilla articulada ajustable aislada para trabajos en equipos de hasta 1000V



7224S

IEC60900 1000V

16	250	4	7224S

Alicate boca semirredonda 60° de seguridad



2427V

IEC60900 1000V

3.0	200	2	2427V-200

Pelacables aislado 1000V
Alambre de cobre y cable

ergo



2223S

IEC60900 1000V

165		5	2223 S-150

Llave ajustable de seguridad 1000 V
Moleta central



8070V - 8074V

IEC60900 1000V

165mm/6"		2	8070V
205mm/8"		2	8071V
260mm/10"		2	8072V
310mm/12"		2	8073V
390mm/15"		2	8074V

Alicate boca plana de seguridad



2421V

IEC60900 1000V

160		2	2421V-160

Pelacables de seguridad
Para alambre de cobre y cable



2223V

IEC60900 1000V

160	0.5-5	2	2223V-160

Llave ajustable moleta lateral de seguridad



8070VL-8073VL

IEC60900 1000V

160mm/6"		1	8070VL
210mm/8"		1	8071VL
		1	8072VL
310mm/12"		1	8073VL

Llave ajustable de seguridad, moleta lateral 1000 V



8071VLT - 8073VLT

IEC60900 1000V

205mm/8"	1	8071VLT
255mm/10"	1	8072VLT
305mm/12"	1	8073VLT

8.0	5	2MV-8
9.0	5	2MV-9
10.0	5	2MV-10
11.0	5	2MV-11
12.0	5	2MV-12
13.0	5	2MV-13
14.0	5	2MV-14
15.0	5	2MV-15
16.0	5	2MV-16
17.0	3	2MV-17
18.0	3	2MV-18
19.0	3	2MV-19
21.0	3	2MV-21
22.0	3	2MV-22
23.0	3	2MV-23
24.0	3	2MV-24

Llave fija de una boca 1000V



6MV

IEC60900 1000V

6	5	6MV-6
7	5	6MV-7
8	5	6MV-8
9	5	6MV-9
10	5	6MV-10
11	5	6MV-11
12	5	6MV-12
13	5	6MV-13
14	5	6MV-14
15	5	6MV-15
16	5	6MV-16
17	3	6MV-17
18	3	6MV-18
19	3	6MV-19
20	3	6MV-20
21	3	6MV-21
22	3	6MV-22
23	3	6MV-23
24	3	6MV-24
27	2	6MV-27
30	2	6MV-30
32	2	6MV-32

Llave de tubo con mango en "T" 1000V



28MV

IEC60900 1000V

8.0	2	28MV-8
9.0	2	28MV-9
10.0	2	28MV-10
11.0	2	28MV-11
12.0	2	28MV-12
13.0	2	28MV-13
14.0	2	28MV-14
15.0	2	28MV-15
16.0	2	28MV-16
17.0	2	28MV-17
18.0	2	28MV-18
19.0	2	28MV-19
20.0	2	28MV-20
21.0	2	28MV-21
22.0	2	28MV-22

Llave en cruz aislada 1000V



2820V

IEC60900 1000V

7x9x11x13	1	2820V13
8x10x13x17	1	2820V17

Llave estrella acodada de una boca 1000V



2MV

IEC60900 1000V

6.0	5	2MV-6
7.0	5	2MV-7

Llave hexagonal macho acodada 1000V



1999MV

IEC60900 1000V

3	5	1999MV-3
4	5	1999MV-4
5	5	1999MV-5
6	5	1999MV-6
7	5	1999MV-7
8	5	1999MV-8
9	5	1999MV-9
10	3	1999MV-10
12	3	1999MV-12

VASOS Y CARRACAS AISLADOS

Llave de vaso de 1/2" 1000V



7800DMV

IEC60900 1000V

8	10	7800DMV-8
10	10	7800DMV-10
11	10	7800DMV-11
12	10	7800DMV-12
13	10	7800DMV-13
14	10	7800DMV-14
15	10	7800DMV-15
16	10	7800DMV-16
17	10	7800DMV-17
18	10	7800DMV-18
19	10	7800DMV-19
20	10	7800DMV-20
21	10	7800DMV-21
22	10	7800DMV-22
24	5	7800DMV-24
27	5	7800DMV-27
30	5	7800DMV-30
32	5	7800DMV-32



Llave de carraca de 1/2" de seguridad 1000V



8150-1/2V

IEC60900 1000V

270	1	8150-1/2V

Mango en "T" de 1/2" de seguridad 1000V



8154-1/2V

IEC60900 1000V

200	190 mm	1	8154-1/2V

Alargadera de 1/2" de seguridad, 1000V



8160-1/2V - 8162-1/2V

IEC60900 1000V

125	1	8160-1/2V
250	1	8162-1/2V

TIJERAS Y CUCHILLOS

Tijera para electricista aislada 1000V



SC127V

IEC60900 1000V

50 mm	130	5	SC127V

Tijera para electricista de seguridad Extra fuerte 1000V



SC150NGV

IEC60900 1000V

38 mm	150	5	SC150NGV

Cuchillo recto aislado 1000V



2820VP

IEC60900 1000V

50 mm	180	2	2820VP

Cuchillo curvo de seguridad 1000V



2820VPC

IEC60900 1000V

50 mm	180	2	2820VPC

Cuchillo curvo con protección aislado 1000V



2820VHELP

IEC60900 1000V

38 mm	180	1	2820VHELP

Cuchillo aislado con capuchon protector de plástico



2820VDE

IEC60900 1000V

55.5 mm	180	10	2820VDE

PINZAS

Pinzas de seguridad 1000V



2820VTEE

IEC60900 1000V

150	1	2820VTEE

EQUIPOS DE PROTECCIÓN

Empuñadura de seguridad 1000V



2820VFP

IEC60900 1000V

458	1	2820VFP

Alfombra aislada 1000V



2820VM

IEC60900

1000	1000	1	2820VM

Guantes aislados
1000V



2820VG

IEC60900

500 V	1 2820VG05
1000 V	1 2820VG10

Guantes de algodón
Uso bajo guantes aislados



2820VGCOT

50	1 2820VGCOT

JUEGOS DE HERRAMIENTAS

Juego de 8 llaves fijas, 1000V



6MV/

IEC60900

8	1 6MV/8T

6MV-10, 6MV-11, 6MV-12, 6MV-13,
6MV-14, 6MV-17, 6MV-18, 6MV-19

IEC60900

Juego de 10 llaves fijas, 1000V
10 piezas



6MV/10T

IEC60900

10	1 6MV/10T

6MV-10, 6MV-11, 6MV-12, 6MV-13,
6MV-14, 6MV-16, 6MV-17, 6MV-18,
6MV-19, 6MV-22

IEC60900





BAHCO



Herramientas antichispa







LLAVES

Llave ajustable anti chispa, AL-BR







NS001

				
18		150mm/6"	1	NS001-150
24		200mm/8"	1	NS001-200
30		250mm/10"	1	NS001-250
36		300mm/12"	1	NS001-300
46		375mm/15"	1	NS001-375
55		450mm/18"	1	NS001-450
65		600mm/24"	1	NS001-600
75		900mm/36"	1	NS001-900

Llave ajustable anti chispa, CU-BE





NSB001

				
18		150mm/6"	1	NSB001-150
24		200mm/8"	1	NSB001-200
30		250mm/10"	1	NSB001-250
36		300mm/12"	1	NSB001-300
48		375mm/15"	1	NSB001-375
55		450mm/18"	1	NSB001-450
65		600mm/24"	1	NSB001-600
75		900mm/36"	1	NSB001-900

Llave combinada anti chispa, AL-BR





NS002

			
6		1	NS002-6
7		1	NS002-7
8		1	NS002-8
9		1	NS002-9
10		1	NS002-10
11		1	NS002-11
12		1	NS002-12
13		1	NS002-13
14		1	NS002-14
15		1	NS002-15
16		1	NS002-16
17		1	NS002-17
18		1	NS002-18
19		1	NS002-19
20		1	NS002-20
21		1	NS002-21
22		1	NS002-22
23		1	NS002-23
24		1	NS002-24
25		1	NS002-25
26		1	NS002-26
27		1	NS002-27
28		1	NS002-28
29		1	NS002-29
30		1	NS002-30
31		1	NS002-31
32		1	NS002-32
33		1	NS002-33
34		1	NS002-34
35		1	NS002-35
36		1	NS002-36
38		1	NS002-38
40		1	NS002-40
41		1	NS002-41
42		1	NS002-42
46		1	NS002-46
50		1	NS002-50
52		1	NS002-52
55		1	NS002-55
60		1	NS002-60
65		1	NS002-65
70		1	NS002-70
75		1	NS002-75
80		1	NS002-80

Llave combinada anti chispa, CU-BE



NSB002

			
6 mm		1	NSB002-6
7 mm		1	NSB002-7
8 mm		1	NSB002-8
9 mm		1	NSB002-9
10 mm		1	NSB002-10
11 mm		1	NSB002-11
12 mm		1	NSB002-12
13 mm		1	NSB002-13
17 mm		1	NSB002-17
14 mm		1	NSB002-14
15 mm		1	NSB002-15
16 mm		1	NSB002-16
18 mm		1	NSB002-18
19 mm		1	NSB002-19
20 mm		1	NSB002-20
21 mm		1	NSB002-21
22 mm		1	NSB002-22
25 mm		1	NSB002-25
23 mm		1	NSB002-23
26 mm		1	NSB002-26
24 mm		1	NSB002-24
27 mm		1	NSB002-27
28 mm		1	NSB002-28
29 mm		1	NSB002-29
30 mm		1	NSB002-30
31 mm		1	NSB002-31
32 mm		1	NSB002-32
33 mm		1	NSB002-33
34 mm		1	NSB002-34
35 mm		1	NSB002-35
36 mm		1	NSB002-36
38 mm		1	NSB002-38
40 mm		1	NSB002-40
41 mm		1	NSB002-41
42 mm		1	NSB002-42
46 mm		1	NSB002-46
50 mm		1	NSB002-50
52 mm		1	NSB002-52
55 mm		1	NSB002-55
60 mm		1	NSB002-60
65 mm		1	NSB002-65
70 mm		1	NSB002-70
75 mm		1	NSB002-75
80 mm		1	NSB002-80

Llave Fija anti chispa, AL-BR



NS006

6x7 mm	1	NS006-0607		
6x8 mm	1	NS006-0608		
7x8 mm	1	NS006-0708		
7x9 mm	1	NS006-0709		
8x9 mm	1	NS006-0809		
8x10 mm	1	NS006-0810		
9x10 mm	1	NS006-0910		
9x11 mm	1	NS006-0911		
10x11 mm	1	NS006-1011		
10x12 mm	1	NS006-1012		
10x13 mm	1	NS006-1013		
10x14 mm	1	NS006-1014		
11x13 mm	1	NS006-1113		
11x14 mm	1	NS006-1114		
12x13 mm	1	NS006-1213		
12x14 mm	1	NS006-1214		
13x15 mm	1	NS006-1315		
14x15 mm	1	NS006-1415		
14x16 mm	1	NS006-1416		
14x17 mm	1	NS006-1417		
16x17 mm	1	NS006-1617		
16x18 mm	1	NS006-1618		
17x19 mm	1	NS006-1719		
17x22 mm	1	NS006-1722		
18x19 mm	1	NS006-1819		
18x20 mm	1	NS006-1820		
19x20 mm	1	NS006-1920		
19x22 mm	1	NS006-1922		
19x24 mm	1	NS006-1924		
20x22 mm	1	NS006-2022		
21x22 mm	1	NS006-2122		
21x23 mm	1	NS006-2123		
22x23 mm	1	NS006-2223		
22x24 mm	1	NS006-2224		
22x27 mm	1	NS006-2227		
23x26 mm	1	NS006-2326		
24x25 mm	1	NS006-2425		
24x26 mm	1	NS006-2426		
24x27 mm	1	NS006-2427		
24x30 mm	1	NS006-2430		
25x28 mm	1	NS006-2528		
26x29 mm	1	NS006-2629		
27x29 mm	1	NS006-2729		
27x30 mm	1	NS006-2730		
27x32 mm	1	NS006-2732		
28x30 mm	1	NS006-2830		
30x31 mm	1	NS006-3031		
30x32 mm	1	NS006-3032		
30x34 mm	1	NS006-3034		
30x36 mm	1	NS006-3036		
32x34 mm	1	NS006-3234		
32x35 mm	1	NS006-3235		
32x36 mm	1	NS006-3236		
33x35 mm	1	NS006-3335		
34x36 mm	1	NS006-3436		
35x36 mm	1	NS006-3536		
36x38 mm	1	NS006-3638		
36x41 mm	1	NS006-3641		
38x42 mm	1	NS006-3642		
41x46 mm	1	NS006-4146		

46x50 mm	1	NS006-4650		
50x52 mm	1	NS006-5052		
50x55 mm	1	NS006-5055		
50x60 mm	1	NS006-5060		
50x62 mm	1	NS006-5062		
55x60 mm	1	NS006-5560		
60x65 mm	1	NS006-6065		
65x70 mm	1	NS006-6570		

Llave fija anti chispa, CU-BE



NSB006

6X7 mm	1	NSB006-0607		
6X8 mm	1	NSB006-0608		
7X8 mm	1	NSB006-0708		
7X9 mm	1	NSB006-0709		
8X9 mm	1	NSB006-0809		
8X10 mm	1	NSB006-0810		
9X10 mm	1	NSB006-0910		
9X11 mm	1	NSB006-0911		
10X11 mm	1	NSB006-1011		
10X12 mm	1	NSB006-1012		
10X13 mm	1	NSB006-1013		
10X14 mm	1	NSB006-1014		
11X13 mm	1	NSB006-1113		
11X14 mm	1	NSB006-1114		
12X13 mm	1	NSB006-1213		
12X14 mm	1	NSB006-1214		
13X15 mm	1	NSB006-1315		
14X15 mm	1	NSB006-1415		
14X16 mm	1	NSB006-1416		
14X17 mm	1	NSB006-1417		
16X17 mm	1	NSB006-1617		
16X18 mm	1	NSB006-1618		
17X19 mm	1	NSB006-1719		
17X22 mm	1	NSB006-1722		
18X19 mm	1	NSB006-1819		
18X20 mm	1	NSB006-1820		
19X20 mm	1	NSB006-1920		
19X22 mm	1	NSB006-1922		
19X24 mm	1	NSB006-1924		
20X22 mm	1	NSB006-2022		
21X22 mm	1	NSB006-2122		
21X23 mm	1	NSB006-2123		
22X23 mm	1	NSB006-2223		
22X24 mm	1	NSB006-2224		
22X27 mm	1	NSB006-2227		
23X26 mm	1	NSB006-2326		
24X25 mm	1	NSB006-2425		
24X26 mm	1	NSB006-2426		
24X27 mm	1	NSB006-2427		
24x30 mm	1	NSB006-2430		
25x28 mm	1	NSB006-2528		
26x29 mm	1	NSB006-2629		
27-29 mm	1	NSB006-2729		
27x30 mm	1	NSB006-2730		
27x32 mm	1	NSB006-2732		
28x30 mm	1	NSB006-2830		

30x31 mm	1	NSB006-3031		
30x32 mm	1	NSB006-3032		
30x34 mm	1	NSB006-3034		
30x36 mm	1	NSB006-3036		
32x34 mm	1	NSB006-3234		
32x35 mm	1	NSB006-3235		
32x36 mm	1	NSB006-3236		
33x35 mm	1	NSB006-3335		
34x36 mm	1	NSB006-3436		
35x36 mm	1	NSB006-3536		
36x38 mm	1	NSB006-3638		
36x41 mm	1	NSB006-3641		
38x42 mm	1	NSB006-3642		
41x46 mm	1	NSB006-4146		
46x50 mm	1	NSB006-4650		
50x52 mm	1	NSB006-5052		
50x55 mm	1	NSB006-5055		
50x60 mm	1	NSB006-5060		
50x62 mm	1	NSB006-5062		
55x60 mm	1	NSB006-5560		
60x65 mm	1	NSB006-6065		
65x70 mm	1	NSB006-6570		

Llave estrella plana anti chispa, AL-BR



NS010

6x7	1	NS010-0607		
7x9	1	NS010-0709		
8x9	1	NS010-0809		
9x11	1	NS010-0911		
10x11	1	NS010-1011		
10x12	1	NS010-1012		
12x14	1	NS010-1214		
13x15	1	NS010-1315		
14x17	1	NS010-1417		
16x18	1	NS010-1618		
17x19	1	NS010-1719		
17x22	1	NS010-1722		
18x19	1	NS010-1819		
19x21	1	NS010-1921		
19x22	1	NS010-1922		
20x22	1	NS010-2022		
21x23	1	NS010-2123		
22x24	1	NS010-2224		
24x27	1	NS010-2427		
25x28	1	NS010-2528		
26x28	1	NS010-2628		
27x30	1	NS010-2730		
27x32	1	NS010-2732		
30x32	1	NS010-3032		
30x36	1	NS010-3036		
32x36	1	NS010-3236		
36x41	1	NS010-3641		
41x46	1	NS010-4146		
46x50	1	NS010-4650		



Llave estrella plana anti chispa, CU-BE



NSB010

Diagram	Diagram		
		6X7 mm	1 NSB010-0607
		7X9 mm	1 NSB010-0709
		8X9 mm	1 NSB010-0809
		9X11 mm	1 NSB010-0911
		10X11 mm	1 NSB010-1011
		10X12 mm	1 NSB010-1012
		12X14 mm	1 NSB010-1214
		13X15 mm	1 NSB010-1315
		14X17 mm	1 NSB010-1417
		16X18 mm	1 NSB010-1618
		17X19 mm	1 NSB010-1719
		17X22 mm	1 NSB010-1722
		18X19 mm	1 NSB010-1819
		19X21 mm	1 NSB010-1921
		19X22 mm	1 NSB010-1922
		20X22 mm	1 NSB010-2022
		21X23 mm	1 NSB010-2123
		22X24 mm	1 NSB010-2224
		24X27 mm	1 NSB010-2427
		25X28 mm	1 NSB010-2528
		26X28 mm	1 NSB010-2628
		27X30 mm	1 NSB010-2730
		27X32 mm	1 NSB010-2732
		30X32 mm	1 NSB010-3032
		30X36 mm	1 NSB010-3036
		32X36 mm	1 NSB010-3236
		36X41 mm	1 NSB010-3641
		41X46 mm	1 NSB010-4146
		46X50 mm	1 NSB010-4650

Llaves fijas estrella acodada anti chispa, AL-BR



NS011

Diagram	Diagram		
		6x7 mm	1 NS011-0607
		8x9 mm	1 NS011-0809
		10x11 mm	1 NS011-1011
		12x13 mm	1 NS011-1213
		14x15 mm	1 NS011-1415
		16x17 mm	1 NS011-1617
		18x19 mm	1 NS011-1819
		20x22 mm	1 NS011-2022
		21x23 mm	1 NS011-2123
		24x26 mm	1 NS011-2426
		25x28 mm	1 NS011-2528
		27x29 mm	1 NS011-2729

Diagram	Diagram		
		30x32 mm	1 NS011-3032

Llaves fijas estrella acodada anti chispa, CU-BE



NSB011

Diagram	Diagram		
		6x7 mm	1 NSB011-0607
		8x9 mm	1 NSB011-0809
		10x11 mm	1 NSB011-1011
		12x13 mm	1 NSB011-1213
		14x15 mm	1 NSB011-1415
		16x17 mm	1 NSB011-1617
		18x19 mm	1 NSB011-1819
		20x22 mm	1 NSB011-2022
		21x23 mm	1 NSB011-2123
		24x26 mm	1 NSB011-2426
		25x28 mm	1 NSB011-2528
		27x29 mm	1 NSB011-2729
		30x32 mm	1 NSB011-3032

Llave de golpe boca fija anti chispa, AL-BR



NS100

Diagram	Diagram		
		17	1 NS100-17
		19	1 NS100-19
		22	1 NS100-22
		24	1 NS100-24
		25	1 NS100-25
		27	1 NS100-27
		28	1 NS100-28
		29	1 NS100-29
		30	1 NS100-30
		32	1 NS100-32
		33	1 NS100-33
		34	1 NS100-34
		35	1 NS100-35
		36	1 NS100-36
		37	1 NS100-37
		38	1 NS100-38
		41	1 NS100-41
		42	1 NS100-42
		45	1 NS100-45
		46	1 NS100-46
		47	1 NS100-47



Diagram	Diagram		
		50	1 NS100-50
		52	1 NS100-52
		54	1 NS100-54
		55	1 NS100-55
		56	1 NS100-56
		58	1 NS100-58
		60	1 NS100-60
		63	1 NS100-63
		65	1 NS100-65
		67	1 NS100-67
		70	1 NS100-70
		71	1 NS100-71
		75	1 NS100-75
		77	1 NS100-77
		80	1 NS100-80
		82	1 NS100-82
		85	1 NS100-85
		88	1 NS100-88
		90	1 NS100-90
		94	1 NS100-94
		95	1 NS100-95
		100	1 NS100-100
		105	1 NS100-105
		110	1 NS100-110
		115	1 NS100-115
		120	1 NS100-120

Llave de golpe boca fija anti chispa, CU-BE



NSB100



Diagram	Diagram		
		17	1 NSB100-17
		19	1 NSB100-19
		22	1 NSB100-22
		24	1 NSB100-24
		25	1 NSB100-25
		27	1 NSB100-27
		28	1 NSB100-28
		29	1 NSB100-29
		30	1 NSB100-30
		32	1 NSB100-32
		33	1 NSB100-33
		34	1 NSB100-34
		35	1 NSB100-35
		36	1 NSB100-36
		37	1 NSB100-37
		38	1 NSB100-38
		41	1 NSB100-41
		42	1 NSB100-42
		45	1 NSB100-45
		46	1 NSB100-46
		47	1 NSB100-47
		50	1 NSB100-50
		52	1 NSB100-52
		54	1 NSB100-54
		55	1 NSB100-55
		56	1 NSB100-56
		58	1 NSB100-58
		60	1 NSB100-60



	 
63	1 NSB100-63
65	1 NSB100-65
67	1 NSB100-67
70	1 NSB100-70
71	1 NSB100-71
75	1 NSB100-75
77	1 NSB100-77
80	1 NSB100-80
82	1 NSB100-82
85	1 NSB100-85
88	1 NSB100-88
90	1 NSB100-90
94	1 NSB100-94
95	1 NSB100-95
100	1 NSB100-100
105	1 NSB100-105
110	1 NSB100-110
115	1 NSB100-115
120	1 NSB100-120

Llave estrella de golpeo anti chispa, AL-BR



NS104



	 
17 mm	1 NS104-17
19 mm	1 NS104-19
20 mm	1 NS104-20
22 mm	1 NS104-22
24 mm	1 NS104-24
25 mm	1 NS104-25
26 mm	1 NS104-26
27 mm	1 NS104-27
28 mm	1 NS104-28
29 mm	1 NS104-29
30 mm	1 NS104-30
31 mm	1 NS104-31
32 mm	1 NS104-32
33 mm	1 NS104-33
34 mm	1 NS104-34
35 mm	1 NS104-35
36 mm	1 NS104-36
37 mm	1 NS104-37
38 mm	1 NS104-38
39 mm	1 NS104-39
40 mm	1 NS104-40
41 mm	1 NS104-41
42 mm	1 NS104-42
43 mm	1 NS104-43
44 mm	1 NS104-44
45 mm	1 NS104-45
46 mm	1 NS104-46
47 mm	1 NS104-47
48 mm	1 NS104-48
49 mm	1 NS104-49
50 mm	1 NS104-50
51 mm	1 NS104-51
52 mm	1 NS104-52
53 mm	1 NS104-53
54 mm	1 NS104-54
55 mm	1 NS104-55



	 
56 mm	1 NS104-56
57 mm	1 NS104-57
58 mm	1 NS104-58
59 mm	1 NS104-59
60 mm	1 NS104-60
61 mm	1 NS104-61
62 mm	1 NS104-62
63 mm	1 NS104-63
64 mm	1 NS104-64
65 mm	1 NS104-65
66 mm	1 NS104-66
67 mm	1 NS104-67
68 mm	1 NS104-68
69 mm	1 NS104-69
70 mm	1 NS104-70
71 mm	1 NS104-71
72 mm	1 NS104-72
73 mm	1 NS104-73
74 mm	1 NS104-74
75 mm	1 NS104-75
76 mm	1 NS104-76
77 mm	1 NS104-77
78 mm	1 NS104-78
79 mm	1 NS104-79
80 mm	1 NS104-80
81 mm	1 NS104-81
82 mm	1 NS104-82
83 mm	1 NS104-83
84 mm	1 NS104-84
85 mm	1 NS104-85
86 mm	1 NS104-86
87 mm	1 NS104-87
88 mm	1 NS104-88
89 mm	1 NS104-89
90 mm	1 NS104-90
92 mm	1 NS104-92
94 mm	1 NS104-94
95 mm	1 NS104-95
98 mm	1 NS104-98
100 mm	1 NS104-100
105 mm	1 NS104-105
110 mm	1 NS104-110
115 mm	1 NS104-115
120 mm	1 NS104-120

Llave de estrella de golpeo anti chispa, mm, CU-BE



NSB104

	 
17 mm	1 NSB104-17
19 mm	1 NSB104-19
20 mm	1 NSB104-20
22 mm	1 NSB104-22
24 mm	1 NSB104-24
25 mm	1 NSB104-25
26 mm	1 NSB104-26
27 mm	1 NSB104-27
28 mm	1 NSB104-28
29 mm	1 NSB104-29
30 mm	1 NSB104-30

	 
31 mm	1 NSB104-31
32 mm	1 NSB104-32
33 mm	1 NSB104-33
34 mm	1 NSB104-34
35 mm	1 NSB104-35
36 mm	1 NSB104-36
37 mm	1 NSB104-37
38 mm	1 NSB104-38
39 mm	1 NSB104-39
40 mm	1 NSB104-40
41 mm	1 NSB104-41
42 mm	1 NSB104-42
43 mm	1 NSB104-43
44 mm	1 NSB104-44
45 mm	1 NSB104-45
46 mm	1 NSB104-46
47 mm	1 NSB104-47
48 mm	1 NSB104-48
49 mm	1 NSB104-49
50 mm	1 NSB104-50
51 mm	1 NSB104-51
52 mm	1 NSB104-52
53 mm	1 NSB104-53
54 mm	1 NSB104-54
55 mm	1 NSB104-55
56 mm	1 NSB104-56
57 mm	1 NSB104-57
58 mm	1 NSB104-58
59 mm	1 NSB104-59
60 mm	1 NSB104-60
61 mm	1 NSB104-61
62 mm	1 NSB104-62
63 mm	1 NSB104-63
64 mm	1 NSB104-64
65 mm	1 NSB104-65
66 mm	1 NSB104-66
67 mm	1 NSB104-67
68 mm	1 NSB104-68
69 mm	1 NSB104-69
70 mm	1 NSB104-70
71 mm	1 NSB104-71
72 mm	1 NSB104-72
73 mm	1 NSB104-73
74 mm	1 NSB104-74
75 mm	1 NSB104-75
76 mm	1 NSB104-76
77 mm	1 NSB104-77
78 mm	1 NSB104-78
79 mm	1 NSB104-79
80 mm	1 NSB104-80
81 mm	1 NSB104-81
82 mm	1 NSB104-82
83 mm	1 NSB104-83
84 mm	1 NSB104-84
85 mm	1 NSB104-85
86 mm	1 NSB104-86
87 mm	1 NSB104-87
88 mm	1 NSB104-88
89 mm	1 NSB104-89
90 mm	1 NSB104-90
92 mm	1 NSB104-92
94 mm	1 NSB104-94
95 mm	1 NSB104-95
98 mm	1 NSB104-98
100 mm	1 NSB104-100
105 mm	1 NSB104-105
110 mm	1 NSB104-110
115 mm	1 NSB104-115
120 mm	1 NSB104-120



Llave estrella de golpe anti chispa, AL-BR



NS106

5/8"	1	NS106-20		
11/16"	1	NS106-22		
3/4"	1	NS106-24		
25/32"	1	NS106-25		
13/16"	1	NS106-26		
7/8"	1	NS106-28		
15/16"	1	NS106-30		
1"	1	NS106-32		
1 1/16"	1	NS106-34		
1 1/8"	1	NS106-36		
1 3/16"	1	NS106-38		
1 1/4"	1	NS106-40		
1 5/16"	1	NS106-42		
1 3/8"	1	NS106-44		
1 13/32"	1	NS106-45		
1 7/16"	1	NS106-46		
1 1/2"	1	NS106-48		
1 9/16"	1	NS106-50		
1 5/8"	1	NS106-52		
1 11/16"	1	NS106-54		
1 3/4"	1	NS106-56		
1 13/16"	1	NS106-58		
1 7/8"	1	NS106-60		
1 15/16"	1	NS106-62		
2"	1	NS106-64		
2 1/16"	1	NS106-66		
2 1/8"	1	NS106-68		
2 3/16"	1	NS106-70		
2 13/64"	1	NS106-71		
2 1/4"	1	NS106-72		
2 5/16"	1	NS106-74		
2 3/8"	1	NS106-76		
2 7/16"	1	NS106-78		
2 1/2"	1	NS106-80		
2 9/16"	1	NS106-82		
2 5/8"	1	NS106-84		
2 3/4"	1	NS106-88		
2 13/16"	1	NS106-90		
2 7/8"	1	NS106-92		
2 15/16"	1	NS106-94		
3"	1	NS106-96		
3 1/16"	1	NS106-98		
3 1/8"	1	NS106-100		
3 1/4"	1	NS106-104		
3 3/8"	1	NS106-108		
3 1/2"	1	NS106-112		
3 9/16"	1	NS106-114		
3 5/8"	1	NS106-116		
3 3/4"	1	NS106-120		
3 7/8"	1	NS106-124		
3 15/16"	1	NS106-126		
4"	1	NS106-128		
4 1/8"	1	NS106-132		
4 1/4"	1	NS106-136		
4 5/16"	1	NS106-138		

4 1/2"	1	NS106-144		
4 9/16"	1	NS106-146		
4 11/16"	1	NS106-150		
4 7/8"	1	NS106-156		
4 15/16"	1	NS106-158		

Llave de estrella de golpe anti chispa, pulgadas, CU-BE



NSB106

5/8"	1	NSB106-20		
11/16"	1	NSB106-22		
3/4"	1	NSB106-24		
25/32"	1	NSB106-25		
13/16"	1	NSB106-26		
7/8"	1	NSB106-28		
15/16"	1	NSB106-30		
1"	1	NSB106-32		
1.1/16"	1	NSB106-34		
1.1/8"	1	NSB106-36		
1.3/16"	1	NSB106-38		
1.1/4"	1	NSB106-40		
1.5/16"	1	NSB106-42		
1.3/8"	1	NSB106-44		
1.13/32"	1	NSB106-45		
1.7/16"	1	NSB106-46		
1.1/2"	1	NSB106-48		
1.9/16"	1	NSB106-50		
1.5/8"	1	NSB106-52		
1.11/16"	1	NSB106-54		
1.3/4"	1	NSB106-56		
1.13/16"	1	NSB106-58		
1.7/8"	1	NSB106-60		
1.15/16"	1	NSB106-62		
2"	1	NSB106-64		
2.1/16"	1	NSB106-66		
2.1/8"	1	NSB106-68		
2.3/16"	1	NSB106-70		
2.13/64"	1	NSB106-71		
2.1/4"	1	NSB106-72		
2.5/16"	1	NSB106-74		
2.3/8"	1	NSB106-76		
2.7/16"	1	NSB106-78		
2.1/2"	1	NSB106-80		
2.9/16"	1	NSB106-82		
2.5/8"	1	NSB106-84		
2.3/4"	1	NSB106-88		
2.13/16"	1	NSB106-90		
2.7/8"	1	NSB106-92		
2.15/16"	1	NSB106-94		
3"	1	NSB106-96		
3.1/16"	1	NSB106-98		
3.1/8"	1	NSB106-100		
3.1/4"	1	NSB106-104		
3.3/8"	1	NSB106-108		
3.1/2"	1	NSB106-112		
3.9/16"	1	NSB106-114		
3.5/8"	1	NSB106-116		
3.3/4"	1	NSB106-120		
3.7/8"	1	NSB106-124		
3.15/16"	1	NSB106-126		
4"	1	NSB106-128		
4.1/8"	1	NSB106-132		
4.1/4"	1	NSB106-136		
4.5/16"	1	NSB106-138		

3.7/8"	1	NSB106-124		
3.15/16"	1	NSB106-126		
4"	1	NSB106-128		
4.1/8"	1	NSB106-132		
4.1/4"	1	NSB106-136		
4.5/16"	1	NSB106-138		
4.1/2"	1	NSB106-144		
4.9/16"	1	NSB106-146		
4.11/16"	1	NSB106-150		
4.7/8"	1	NSB106-156		
4.15/16"	1	NSB106-158		

HERRAMIENTAS PARA FONTANERÍA

Llave Stillson anti chispa, AL-BR



NS200

25	200	1	NS200-200
30	250	1	NS200-250
40	300	1	NS200-300
50	350	1	NS200-350
60	450	1	NS200-450
75	600	1	NS200-600
85	900	1	NS200-900
110	1200	1	NS200-1200

Llave Stillson anti chispa, CU-BE



NSB200

25	200	1	NSB200-200
30	250	1	NSB200-250
40	300	1	NSB200-300
50	350	1	NSB200-350
60	450	1	NSB200-450
75	600	1	NSB200-600
85	900	1	NSB200-900
110	1200	1	NSB200-1200

Llave de válvulas larga anti chispa, AL-BR



NS202

L	Icon	Part Number
370		1 NS202-350

Llave válvulas anti chispa, CU-BE



NSB202

L	Icon	Part Number
375		1 NSB202-350

Llave para válvulas anti-chispa, AL-BR



NS203

Icon	Part Number
	1 NS203-200
	1 NS203-215
	1 NS203-290
	1 NS203-400
	1 NS203-490
	1 NS203-800

Llave para válvulas anti-chispa, CU-BE



NSB203

Icon	Part Number
	1 NSB203-200
	1 NSB203-215



- 1 NSB203-290
- 1 NSB203-400
- 1 NSB203-490
- 1 NSB203-800

Llave-gancho girador de válvulas anti chispa, AL-BR



NS204

L	Icon	Part Number
200		1 NS204-30
300		1 NS204-32
250		1 NS204-35
300		1 NS204-40
350		1 NS204-45
375		1 NS204-48
400		1 NS204-50
450		1 NS204-55
500		1 NS204-60
550		1 NS204-65
600		1 NS204-70
650		1 NS204-75
700		1 NS204-80
750		1 NS204-85
800		1 NS204-90

Llave válvulas anti chispa, CU-BE



NSB204

L	Icon	Part Number
200		1 NSB204-30
300		1 NSB204-32
250		1 NSB204-35
300		1 NSB204-40



- 1 NSB204-45
- 1 NSB204-48
- 1 NSB204-50
- 1 NSB204-55
- 1 NSB204-60
- 1 NSB204-65
- 1 NSB204-70
- 1 NSB204-75
- 1 NSB204-80
- 1 NSB204-85
- 1 NSB204-90

VASOS Y CARRACAS

Vaso anti-chispa 1/2", AL-BR



NS220

Icon	Part Number
	1 NS220-06
	1 NS220-07
	1 NS220-08
	1 NS220-09
	1 NS220-10
	1 NS220-11
	1 NS220-12
	1 NS220-13
	1 NS220-14
	1 NS220-15
	1 NS220-16
	1 NS220-17
	1 NS220-18
	1 NS220-19
	1 NS220-20
	1 NS220-21
	1 NS220-22
	1 NS220-23
	1 NS220-24
	1 NS220-25
	1 NS220-26
	1 NS220-27
	1 NS220-28
	1 NS220-29
	1 NS220-30
	1 NS220-32



Vaso anti-chispa 1/2", CU-BE



NSB220

Ø		
6 mm	1	NSB220-06
7 mm	1	NSB220-07
8 mm	1	NSB220-08
9 mm	1	NSB220-09
10 mm	1	NSB220-10
11 mm	1	NSB220-11
12 mm	1	NSB220-12
13 mm	1	NSB220-13
14 mm	1	NSB220-14
15 mm	1	NSB220-15
16 mm	1	NSB220-16
17 mm	1	NSB220-17
18 mm	1	NSB220-18
19 mm	1	NSB220-19
20 mm	1	NSB220-20
21 mm	1	NSB220-21
22 mm	1	NSB220-22
23 mm	1	NSB220-23
24 mm	1	NSB220-24
25 mm	1	NSB220-25
26 mm	1	NSB220-26
27 mm	1	NSB220-27
28 mm	1	NSB220-28
29 mm	1	NSB220-29
30 mm	1	NSB220-30
32 mm	1	NSB220-32

Vaso anti-chispa 3/4", AL-BR



NS224

Ø		
17 mm	1	NS224-17
18 mm	1	NS224-18
19 mm	1	NS224-19
21 mm	1	NS224-21
22 mm	1	NS224-22
23 mm	1	NS224-23
24 mm	1	NS224-24
26 mm	1	NS224-26

Ø		
27 mm	1	NS224-27
28 mm	1	NS224-28
29 mm	1	NS224-29
30 mm	1	NS224-30
32 mm	1	NS224-32
34 mm	1	NS224-34
36 mm	1	NS224-36
38 mm	1	NS224-38
41 mm	1	NS224-41
46 mm	1	NS224-46
50 mm	1	NS224-50

Vaso anti-chispa 3/4", CU-BE



NSB224

Ø		
17 mm	1	NSB224-17
18 mm	1	NSB224-18
19 mm	1	NSB224-19
21 mm	1	NSB224-21
22 mm	1	NSB224-22
23 mm	1	NSB224-23
24 mm	1	NSB224-24
26 mm	1	NSB224-26
27 mm	1	NSB224-27
28 mm	1	NSB224-28
29 mm	1	NSB224-29
30 mm	1	NSB224-30
32 mm	1	NSB224-32
34 mm	1	NSB224-34
36 mm	1	NSB224-36
38 mm	1	NSB224-38
41 mm	1	NSB224-41
46 mm	1	NSB224-46
50 mm	1	NSB224-50

Vaso anti-chispa 1", AL-BR



NS228

Ø		
22 mm	1	NS228-22
24 mm	1	NS228-24

Ø		
26 mm	1	NS228-26
27 mm	1	NS228-27
28 mm	1	NS228-28
29 mm	1	NS228-29
30 mm	1	NS228-30
31 mm	1	NS228-31
32 mm	1	NS228-32
34 mm	1	NS228-34
36 mm	1	NS228-36
38 mm	1	NS228-38
41 mm	1	NS228-41
46 mm	1	NS228-46
50 mm	1	NS228-50
55 mm	1	NS228-55
60 mm	1	NS228-60
65 mm	1	NS228-65
70 mm	1	NS228-70
75 mm	1	NS228-75
80 mm	1	NS228-80

Vaso anti-chispa 1", CU-BE



NSB228

Ø		
22 mm	1	NSB228-22
24 mm	1	NSB228-24
26 mm	1	NSB228-26
27 mm	1	NSB228-27
28 mm	1	NSB228-28
29 mm	1	NSB228-29
30 mm	1	NSB228-30
31 mm	1	NSB228-31
32 mm	1	NSB228-32
34 mm	1	NSB228-34
36 mm	1	NSB228-36
38 mm	1	NSB228-38
41 mm	1	NSB228-41
46 mm	1	NSB228-46
50 mm	1	NSB228-50
55 mm	1	NSB228-55
60 mm	1	NSB228-60
65 mm	1	NSB228-65
70 mm	1	NSB228-70
75 mm	1	NSB228-75
80 mm	1	NSB228-80

Adaptador anti-chispa, AL-BR



NS232

mm	mm		
1/2"	3/4"	1	NS232-16-24
3/4"	1/2"	1	NS232-24-16
3/4"	1"	1	NS232-24-32
1"	3/4"	1	NS232-32-24

Alargadera anti-chispa, CU-BE



NSB234

L	mm		
100 mm	16.4	1	NSB234-16-100
200 mm	16.4	1	NSB234-16-200
250 mm	16.4	1	NSB234-16-250
200 mm	25	1	NSB234-24-200
250 mm	34	1	NSB234-32-250

Mango corregido en T anti-chispa, AL-BR



NS238

mm	L		
1/2"	250	1	NS238-16-250
3/4"	260	1	NS238-24-250
1"	300	1	NS238-32-300

Adaptador anti-chispa, CU-BE



NSB232

mm	mm		
1/2"	3/4"	1	NSB232-16-24
3/4"	1/2"	1	NSB232-24-16
3/4"	1"	1	NSB232-24-32
1"	3/4"	1	NSB232-32-24

Junta universal anti-chispa, AL-BR



NS236

mm	mm		
1/2"	1/2"	1	NS236-16
3/4"	3/4"	1	NS236-24
1"	1"	1	NS236-32

Mango corregido en T anti-chispa, CU-BE



NSB238

mm	L		
1/2"	250	1	NSB238-16-250
3/4"	250	1	NSB238-24-250
1"	300	1	NSB238-32-300

Alargadera anti-chispa, AL-BR



NS234

mm	mm		
1/2"	1/2"	1	NS234-16-100
1/2"	1/2"	1	NS234-16-200
1/2"	1/2"	1	NS234-16-250
3/4"	3/4"	1	NS234-24-200
1"	1"	1	NS234-32-250

Junta universal anti-chispa, CU-BE



NSB236

mm	mm		
1/2"	1/2"	1	NSB236-16
3/4"	3/4"	1	NSB236-24
1"	1"	1	NSB236-32

Mango acodado en T anti-chispa, AL-BR



NS240

mm	L		
1/2"	230 mm	1	NS240-16-230



Mango acodado en T anti-chispa, CU-BE



NSB240

1/2"	370	1	NSB240-16-230

Berbiquí anti-chispa, AL-BR



NS243

1/2"	390 mm	1	NS243-16-400

Vaso anti-chispa para bujías, CU-BE



NSB247

1/2"	13	1	NSB247-26

Llave de carraca anti-chispa, AL-BR



NS242

245 mm	630	1	NS242-16
320 mm	1460	1	NS242-24
550 mm	3190	1	NS242-32

Berbiquí anti-chispa, CU-BE



NSB243

1/2"	395 mm	1	NSB243-16-400

Destornillador Stecker anti-chispa, AL-BR



NS248

13	1	NS248-16-52	

Llave de carraca anti-chispa, CU-BE



NSB242

245 mm	710	1	NSB242-16
320 mm	1660	1	NSB242-24
550 mm	3680	1	NSB242-32

Vaso anti-chispa para bujías, AL-BR



NS247

1/2"	13	1	NS247-26

Destornillador Stecker anti-chispa, CU-BE



NSB248

13	1	NSB248-16-52	

DESTORNILLADORES

Destornillador punta plana ERGO™, AL-BR

ergo®



NS300

Tip	Length	Quantity	Model
3 mm	50 mm	1	NS300-3-50
3 mm	75 mm	1	NS300-3-75
4 mm	75 mm	1	NS300-4-75
4.5 mm	50 mm	1	NS300-4.5-50
4.5 mm	100 mm	1	NS300-4.5-100
5 mm	75 mm	1	NS300-5-75
5 mm	100 mm	1	NS300-5-100
6 mm	100 mm	1	NS300-6-100
6 mm	125 mm	1	NS300-6-125
6 mm	150 mm	1	NS300-6-150
7 mm	150 mm	1	NS300-7-150
8 mm	150 mm	1	NS300-8-150
8 mm	200 mm	1	NS300-8-200
9 mm	250 mm	1	NS300-9-250
10 mm	200 mm	1	NS300-10-200
10 mm	300 mm	1	NS300-10-300
11 mm	250 mm	1	NS300-11-250
11 mm	300 mm	1	NS300-11-300
11 mm	350 mm	1	NS300-11-350
12 mm	400 mm	1	NS300-12-400
13 mm	450 mm	1	NS300-13-450

Destornillador boca Plana ERGO™ anti chispa, CU-BE

ergo®



NSB300

Tip	Length	Quantity	Model
3 mm	50 mm	1	NSB300-3-50
3 mm	75 mm	1	NSB300-3-75
4 mm	75 mm	1	NSB300-4-75
4.5 mm	60 mm	1	NSB300-4.5-50
4.5	95	1	NSB300-4.5-100
5 mm	75 mm	1	NSB300-5-75
5 mm	100 mm	1	NSB300-5-100
6	105	1	NSB300-6-100
6 mm	125 mm	1	NSB300-6-125
6 mm	160 mm	1	NSB300-6-150
7 mm	150 mm	1	NSB300-7-150
8	150	1	NSB300-8-150
8 mm	200 mm	1	NSB300-8-200

Tip	Length	Quantity	Model
9 mm	250 mm	1	NSB300-9-250
9 mm	200 mm	1	NSB300-10-200
10	318	1	NSB300-10-300
11 mm	250 mm	1	NSB300-11-250
11 mm	300 mm	1	NSB300-11-300
11	350	1	NSB300-11-350
12	400	1	NSB300-12-400
13	450	1	NSB300-13-450

Destornilladores electricista anti chispa, AL-BR

ergo®



NS301

Tip	Length	Quantity	Model
3 mm	50 mm	1	NS301-3-50
4 mm	100 mm	1	NS301-4-100
4 mm	150 mm	1	NS301-4-150
5 mm	100 mm	1	NS301-5-100
5 mm	200 mm	1	NS301-5-200
6 mm	100 mm	1	NS301-6-100
8 mm	150 mm	1	NS301-8-150
10 mm	200 mm	1	NS301-10-200
10 mm	300 mm	1	NS301-10-300

Destornilladores electricista, CU-BE

ergo®



NSB301

Tip	Length	Quantity	Model
3 mm	50 mm	1	NSB301-3-50
4 mm	100 mm	1	NSB301-4-100
4 mm	150 mm	1	NSB301-4-150
5 mm	100 mm	1	NSB301-5-100
5 mm	210 mm	1	NSB301-5-200
6 mm	100 mm	1	NSB301-6-100
8 mm	155 mm	1	NSB301-8-150
10 mm	200 mm	1	NSB301-10-200
10 mm	300 mm	1	NSB301-10-300

Destornillador punta PH ERGO™, AL-BR

ergo®



NS302

Tip	Length	Quantity	Model
PH0	50 mm	1	NS302-0-50
PH1	100 mm	1	NS302-1-100
PH2	125 mm	1	NS302-2-125
PH3	150 mm	1	NS302-3-150
PH4	300 mm	1	NS302-4-300

Destornilladores Phillips ERGO™ anti chispa, CU-BE

ergo®



NSB302

Tip	Length	Quantity	Model
PH0	65	1	NSB302-0-50
PH1	120	1	NSB302-1-100
PH2	125	1	NSB302-2-125
PH3	150	1	NSB302-3-150
PH4	300	1	NSB302-4-300

Destornillador punta PZ ERGO™, AL-BR

ergo®



NS304

Tip	Length	Quantity	Model
PZ0	50 mm	1	NS304-0-50
PZ1	100 mm	1	NS304-1-100
PZ2	125 mm	1	NS304-2-125
PZ3	150 mm	1	NS304-3-150
PZ4	300 mm	1	NS304-4-300



Destornillador PZ ERGO™ anti chispa, CU-BE



NSB304

PZ0	50	1	NSB304-0-50	
PZ1	100	1	NSB304-1-100	
PZ2	125	1	NSB304-2-125	
PZ3	150	1	NSB304-3-150	
PZ4	300	1	NSB304-4-300	

Llaves allen anti chispa, AL-BR



NS320

2	3	4	5
6	7	8	9
10			

Llaves hexagonales anti chispa, CU-BE



NSB320

2	3	4	5
6	7	8	9
10			

ALICATES

Alicate universal anti chispa, AL-BR



NS400

155	1	NS400-160
175	1	NS400-180
200	1	NS400-200

Tenazas anti chispa, AL-BR



NS412

200	1	NS412-200

Alicate universal anti chispa, CU-BE



NSB400

157	1	NSB400-160
175	1	NSB400-180
200	1	NSB400-200

Tenazas anti chispa, CU-BE



NSB412

200	1	NSB412-200

Alicate de corte lateral anti chispa, AL-BR



NS402

150	1	NS402-160
200	1	NS402-200

Alicate de corte lateral anti chispa, CU-BE



NSB402

155	1	NSB402-160
200	1	NSB402-200

Alicates corte diagonal HD anti chispa, AL-BR



NS403

150	1	NS403-160
180	1	NS403-180

Alicates corte diagonal heavy duty anti chispa CU-BE



NSB403



155 1 NSB403-160
180 1 NSB403-180

Alicates boca redonda anti chispa, CU-BE



NSB405



155 1 NSB405-160

Pelacables anti chispa, CU-BE



NSB407



170 1 NSB407-160

Alicates boca plana anti chispa, AL-BR



NS404



150 1 NS404-160

Alicate de punta semiredonda anti chispa, AL-BR



NS406



160 1 NS406-160
180 1 NS406-180
200 1 NS406-200

Alicate articulado anti chispa, AL-BR



NS408



260 1 NS408-250
300 1 NS408-300

Alicates boca plana anti chispa, CU-BE



NSB404



155 1 NSB404-160

Alicate de boca semiredonda anti chispa, CU-BE



NSB406



155 1 NSB406-160
180 1 NSB406-180
200 1 NSB406-200

Tenacilla articulada anti chispa, CU-BE



NSB408



255 1 NSB408-250
300 1 NSB408-300

Alicates boca semirredonda anti chispa, AL-BR



NS405



160 1 NS405-160

Pelacables anti chispa, AL-BR



NS407



170 1 NS407-160

Alicates para gas anti chispa, AL-BR



NS411



200 1 NS411-200



Alicates para Gas anti chispa, CU-BE



NSB411

205	1	NSB411-200

Tenazas para carpinteros anti chispa, AL-BR



NS413

180	1	NS413-180
195	1	NS413-200

Tenazas para carpintero anti chispa, CU-BE



NSB413

185	1	NSB413-180
195	1	NSB413-200

MARTILLOS, PALANCAS Y CINCELES

Maza tipo alemán anti chispa, AL-BR



NS500

2000	1	NS500-2000
2500	1	NS500-2500
3000	1	NS500-3000
4000	1	NS500-4000

Martillo tipo Alemán mango fibra de vidrio anti chispa, AL-BR



NS504-FB

100	1	NS504-100-FB
200	1	NS504-200-FB
300	1	NS504-300-FB
500	1	NS504-500-FB
800	1	NS504-800-FB
1000	1	NS504-1000-FB
1500	1	NS504-1500-FB
2000	1	NS504-2000-FB

Martillo de bola con mango de madera anti chispa, AL-BR



NS506

340	1	NS506-300
450	1	NS506-450
670	1	NS506-700
910	1	NS506-900

Martillos mango fibra de vidrio anti chispa, AL-BR



NS508-FB

500	1	NS508-500-FB
700	1	NS508-700-FB

Martillo anti chispa, AL-BR



NS512-FB8

230	1	NS512-200-FB
400	1	NS512-400-FB
640	1	NS512-600-FB
970	1	NS512-900-FB

Maza mango fibra de vidrio anti chispa AL-BR



NS502-FB

450	1	NS502-450-FB
1000	1	NS502-1000-FB
1500	1	NS502-1500-FB
2000	1	NS502-2000-FB
2500	1	NS502-2500-FB
3000	1	NS502-3000-FB
4500	1	NS502-4500-FB
5000	1	NS502-5000-FB
6800	1	NS502-6800-FB
8000	1	NS502-8000-FB
10000	1	NS502-10000-FB
12000	1	NS502-12000-FB

Martillo mecánico anti chispa mango fibra de vidrio, CU-BE



NS5B04-FB

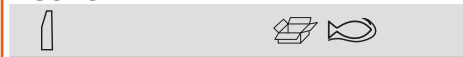

100	1	NSB504-100-FB
200	1	NSB504-200-FB
300	1	NSB504-300-FB
500	1	NSB504-500-FB
800	1	NSB504-800-FB
1000	1	NSB504-1000-FB
1500	1	NSB504-1500-FB
2000	1	NSB504-2000-FB

Martillo de bola con mango de madera anti chispa, CU-BE



NSB506



300	1	NSB506-300
450	1	NSB506-450
680	1	NSB506-700
910	1	NSB506-900

Maza tipo alemán mango fibra vidrio anti chispa



NS500-FB



1000	1	NS500-1000-FB
1500	1	NS500-1500-FB
2000	1	NS500-2000-FB
2500	1	NS500-2500-FB
3000	1	NS500-3000-FB
3500	1	NS500-3500-FB

Maceta cuadrada tipo alemán anti chispa mango madera, CU-BE



NSB500

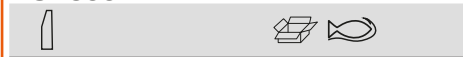

2000	1	NSB500-2000
2500	1	NSB500-2500
3000	1	NSB500-3000
4000	1	NSB500-4000

Martillos mango fibra de vidrio anti chispa, CU-BE



NSB508-FB

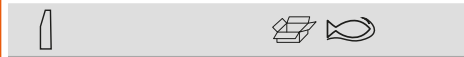

500	1	NSB508-500-FB
700	1	NSB508-700-FB

Martillo de bola anti chispa con mango de fibra de vidrio, AL-BR



NS506-FB



310	1	NS506-300-FB
470	1	NS506-450-FB
700	1	NS506-700-FB
910	1	NS506-900-FB

Martillo octogonal anti chispa mango fibra de vidrio, CU-BE



NSB502-FB

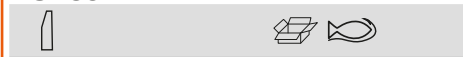

450	1	NSB502-450-FB
1000	1	NSB502-1000-FB
1500	1	NSB502-1500-FB
2000	1	NSB502-2000-FB
2500	1	NSB502-2500-FB
3000	1	NSB502-3000-FB
4500	1	NSB502-4500-FB
5000	1	NSB502-5000-FB
6800	1	NSB502-6800-FB
8000	1	NSB502-8000-FB
10000	1	NSB502-10000-FB
12000	1	NSB502-12000-FB

Martillos mango fibra de vidrio anti chispa, CU-BE



NSB512-FB

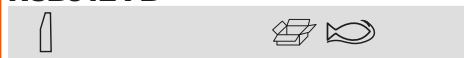

200	1	NSB512-200-FB
400	1	NSB512-400-FB
600	1	NSB512-600-FB
900	1	NSB512-900-FB

Maceta cuadrada tipo alemán anti chispa mango fibra de vidrio, CU-BE



NSB500-FB



1000	1	NSB500-1000-FB
1500	1	NSB500-1500-FB
2000	1	NSB500-2000-FB
2500	1	NSB500-2500-FB
3000	1	NSB500-3000-FB
3500	1	NSB500-3500-FB



Martillo de bola anti chispa con mango de fibra de vidrio, CU-BE



NSB506-FB

Length (mm)	Quantity	Part Number
300	1	NSB506-300-FB
450	1	NSB506-450-FB
680	1	NSB506-700-FB
900	1	NSB506-900-FB

Length (mm)	Quantity	Part Number
135	1	NSB600-135-50
150	1	NSB600-150-25
150	1	NSB600-150-30
150	1	NSB600-150-40
150	1	NSB600-150-50
180	1	NSB600-180-13
180	1	NSB600-180-32
180	1	NSB600-180-50
	1	NSB600-200-20
200	1	NSB600-200-30
200	1	NSB600-200-40
200	1	NSB600-200-50
230	1	NSB600-230-40
250	1	NSB600-250-40
300	1	NSB600-300-50

Buril anti chispa AL-BR



NS604

Length (mm)	Quantity	Part Number
140	1	NS604-150
200	1	NS604-200
300	1	NS604-300

Cuña anti chispa, AL-BR



NS600

Length (mm)	Quantity	Part Number
80	1	NS600-80-13
100	1	NS600-100-50
135	1	NS600-135-50
150	1	NS600-150-25
150	1	NS600-150-30
150	1	NS600-150-40
150	1	NS600-150-50
180	1	NS600-180-13
180	1	NS600-180-32
180	1	NS600-180-50
200	1	NS600-200-20
200	1	NS600-200-30
200	1	NS600-200-40
200	1	NS600-200-50
230	1	NS600-230-40
250	1	NS600-250-40
300	1	NS600-300-50

Palanca anti chispa, AL-BR



NS602

Length (mm)	Quantity	Part Number
16	460	NS602-460
20	600	NS602-600
22	760	NS602-760
22	935	NS602-900

Cinzel anti chispa, CU-BE



NSB604

Length (mm)	Quantity	Part Number
140	1	NSB604-150
200	1	NSB604-200
300	1	NSB604-300

Cuña anti chispa, CU-BE



NSB600

Length (mm)	Quantity	Part Number
80	1	NSB600-80-13
100	1	NSB600-100-50

Palanca anti chispa, CU-BE



NSB6028

Length (mm)	Quantity	Part Number
16 mm	460	NSB602-460
20 mm	600	NSB602-600
22 mm	760	NSB602-760
22 mm	920	NSB602-900

Cortafrios anti chispa AL-BR



NS606

Length (mm)	Quantity	Part Number
150	1	NS606-150
200	1	NS606-200
250	1	NS606-250
300	1	NS606-300
400	1	NS606-400

Cinzel plano anti chispa, CU-BE



NSB606

150	1	NSB606-150
200	1	NSB606-200
250	1	NSB606-250
300	1	NSB606-300
400	1	NSB606-400

Granete mango moleteado anti chispa, AL-BR



NS608

100	1	NS608-100

Granete anti chispa, CU-BE



NSB608

100	1	NSB608-100

RASCADORES

Rsqeta en ángulo anti chispa, AL-BR



NS700

45	300	1	NS700-300

Rasqueta en ángulo anti chispa, CU-BE



NSB700

45	310	1	NSB700-300

Rasqueta plana anti chispa AL-BR



NS702

30	325	1	NS702-200

Rasqueta plana anti chispa, CU-BE



NSB702

20	325	1	NSB702-200

Rasqueta hojas largas anti chispa, AL-BR



NS704

100	225	1	NS704-225

Rasqueta de hoja larga anti chispa, CU-BE



NSB704

100	720	1	NSB704-225



Rasqueta flexible anti chispa, AL-BR



NS706

Icon	L	Icon	Icon
	50	200	1 NS706-50
	80	200	1 NS706-80

Rasqueta triangular anti chispa, CU-BE



NSB708

Icon	L	Icon	Icon
	450		1 NSB708-360

HERRAMIENTAS DE JARDINERÍA

Pico anti chispa, AL-BR



NS800

Icon	L	Icon	Icon
	910		1 NS800-1100
	910		1 NS800-1700
	965		1 NS800-2000

Rasqueta flexible anti chispa, CU-BE



NSB706

Icon	L	Icon	Icon
	50	200	1 NSB706-50
	80	200	1 NSB706-80

Rasqueta triangular anti chispa, AL-BR



NS710

Icon	L	Icon	Icon
	470		1 NS710-450

Pico anti chispa, CU-BE



NSB800

Icon	L	Icon	Icon
	910		1 NSB800-1100
	910		1 NSB800-1700
	910		1 NSB800-2000

Rasqueta triangular anti chispa, AL-BR



NS708

Icon	L	Icon	Icon
	440		1 NS708-360

Rasqueta triangular anti chispa, CU-BE



NSB710

Icon	L	Icon	Icon
	470		1 NSB710-450

Pala de punta redonda anti chispa, AL-BR



NS802

Icon	L	Icon	Icon
	1370		1 NS802-290

Pala redonda anti chispa, CU-BE



NSB802

1450	1	NSB802-290

Extractores reversibles con tres garras anti chispa, CU-BE



NSB810

50-100 mm	105 mm	1	NSB810-100
60-150 mm	175 mm	1	NSB810-150
70-200 mm	250 mm	1	NSB810-200
80-350 mm	320 mm	1	NSB810-350

Cepillo de mano anti chispa, AL-BR



NS804

290	1	NS804-290

EXTRACTORES

Extractores reversibles con tres garras anti chispa, AL-BR



NS810

50-100 mm	105 mm	1	NS810-100
60-150 mm	175 mm	1	NS810-150
70-200 mm	250 mm	1	NS810-200
80-350 mm	320 mm	1	NS810-350



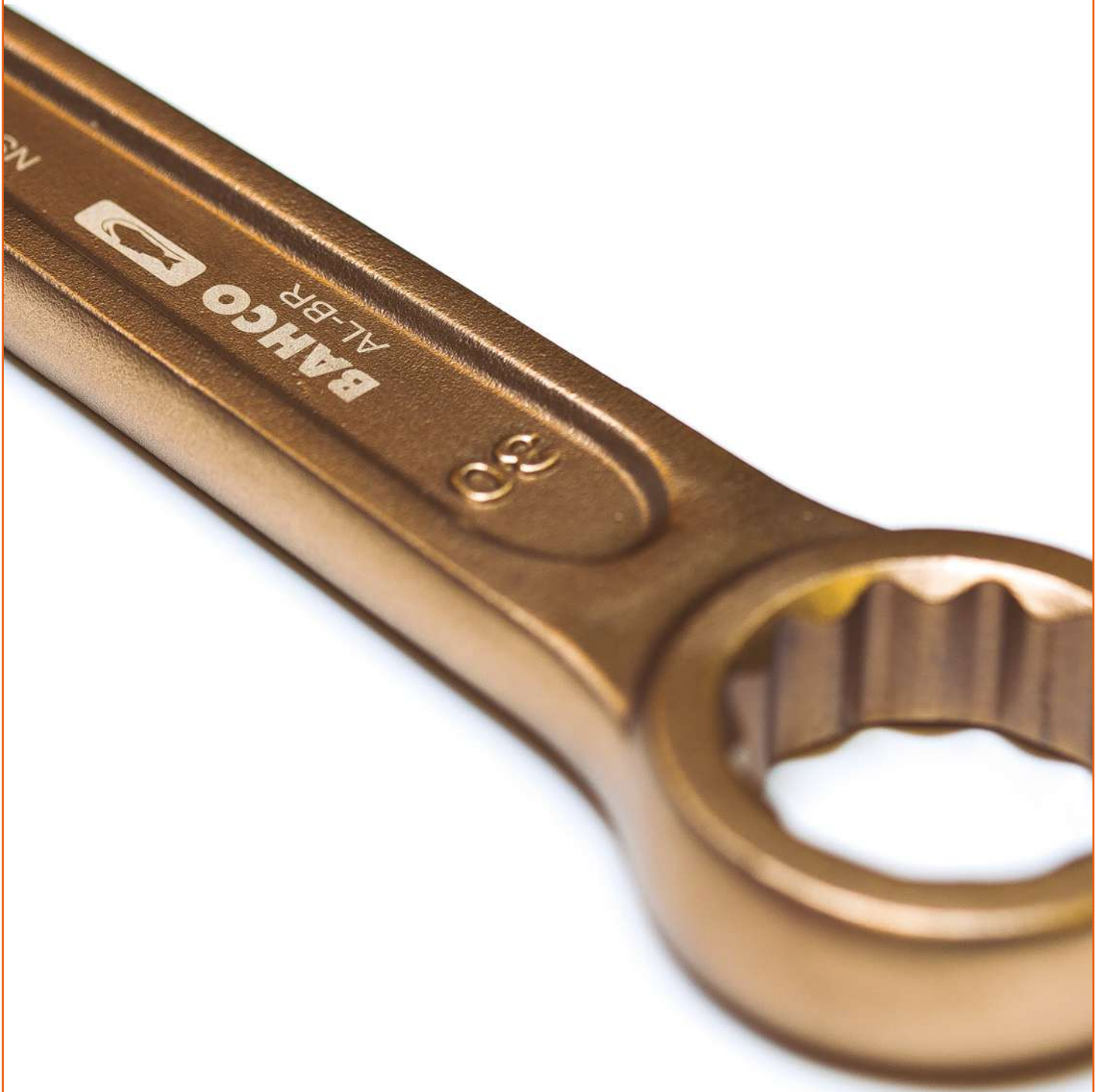

BAHCO



Herramientas de acero inoxidable



CARROS

Carro 7 cajones 26", acero inoxidable
100% fabricado en acero inoxidable



1470K7SS



952 x 500 x 760 mm

1 1470K7SS

Carro 7 cajones 40", acero inoxidable
100% fabricado en acero inoxidable



1475KXL7SS



986 x 501 x 1100 mm

1 1475KXL7SS

LLAVES

Llave ajustable moleta central de acero inoxidable



SS001



Medida	Cantidad	Código
100mm/4"	13	1 SS001-100
150mm/6"	18	1 SS001-150
200mm/8"	24	1 SS001-200
250mm/10"	30	1 SS001-250
300mm/12"	36	1 SS001-300
375mm/15"	46	1 SS001-375
450mm/18"	55	1 SS001-450
600mm/24"	60	1 SS001-600

Llave combinada de acero inoxidable, mm



SS002



6 mm	1	SS002-6
8 mm	1	SS002-8
10 mm	1	SS002-10
11 mm	1	SS002-11
12 mm	1	SS002-12
13 mm	1	SS002-13
14 mm	1	SS002-14
15 mm	1	SS002-15
16 mm	1	SS002-16
17 mm	1	SS002-17
19 mm	1	SS002-19
21 mm	1	SS002-21
22 mm	1	SS002-22
24 mm	1	SS002-24
27 mm	1	SS002-27
32 mm	1	SS002-32

Juego de 6 llaves combinadas de acero inoxidable,
mm
6 piezas



SS002-6-2



6 710 1 SS002-6-2

SS002-10, SS002-12, SS002-14, SS002-17,
SS002-19, SS002-8

Set de 9 llaves combinadas de acero inoxidable, mm
9 piezas



SS002-9-2



9 924 1 SS002-9-2

SS002-10, SS002-11, SS002-12, SS002-13,
SS002-14, SS002-15, SS002-17, SS002-19,
SS002-8



Llave combinada acero inoxidable, pulgadas



SS003



Medida	Longitud (mm)	Cantidad	Código
1/4 in	105	1	SS003-8
5/16 in	120	1	SS003-10
11/32 in	135	1	SS003-11
3/8 in	135	1	SS003-12
7/16 in	150	1	SS003-14
1/2 in	175	1	SS003-16
9/16 in	175	1	SS003-18
5/8 in	195	1	SS003-20
11/16 in	195	1	SS003-22
3/4 in	215	1	SS003-24
25/32 in	215	1	SS003-25
13/16 in	245	1	SS003-26
7/8 in	245	1	SS003-28
15/16 in	265	1	SS003-30

Llave de estrella acodada de acero inoxidable, mm



SS011



Medida	Longitud (mm)	Cantidad	Código
5.5*7 mm	180	1	SS011-0507
6*7 mm	180	1	SS011-0607
8*9 mm	190	1	SS011-0809
8*10 mm	190	1	SS011-0810
9*11 mm	215	1	SS011-0911
10*12 mm	215	1	SS011-1012
12*14 mm	225	1	SS011-1214
14*17 mm	255	1	SS011-1417
16*18 mm	280	1	SS011-1618
17*19 mm	280	1	SS011-1719
17*22 mm	300	1	SS011-1722
22*24 mm	330	1	SS011-2224
24*27 mm	340	1	SS011-2427
24*30 mm	350	1	SS011-2430
30*32 mm	370	1	SS011-3032

VASOS Y CARRACAS

Vaso 1/4" hexagonal de acero inoxidable, en mm



SS210

Ø	L	Icon	Part No.
4 mm	25		1 SS210-4
4.5 mm	25		1 SS210-4.5
5 mm	25		1 SS210-5
5.5 mm	25		1 SS210-5.5
6 mm	25		1 SS210-6
7 mm	25		1 SS210-7
8 mm	25		1 SS210-8
9 mm	25		1 SS210-9
10 mm	25		1 SS210-10
11 mm	25		1 SS210-11
12 mm	26		1 SS210-12
13 mm	26		1 SS210-13
14 mm	26		1 SS210-14

Vaso 1/2" hexagonal de acero inoxidable, en mm



SS220

Ø	L	Icon	Part No.
8 mm	40		1 SS220-8
9 mm	40		1 SS220-9
10 mm	40		1 SS220-10
11 mm	40		1 SS220-11
12 mm	40		1 SS220-12
13 mm	40		1 SS220-13
14 mm	40		1 SS220-14
15 mm	40		1 SS220-15
16 mm	40		1 SS220-16
17 mm	40		1 SS220-17
18 mm	42		1 SS220-18
19 mm	42		1 SS220-19
20 mm	42		1 SS220-20
21 mm	43		1 SS220-21
22 mm	43		1 SS220-22
23 mm	43		1 SS220-23
24 mm	43		1 SS220-24
25 mm	43		1 SS220-25

Ø	L	Icon	Part No.
26 mm	43		1 SS220-26
27 mm	46		1 SS220-27
28 mm	46		1 SS220-28
29 mm	46		1 SS220-29
30 mm	46		1 SS220-30
31 mm	46		1 SS220-31
32 mm	46		1 SS220-32

Vaso 3/4" hexagonal de acero inoxidable, en mm



SS224

Ø	L	Icon	Part No.
17 mm	50		1 SS224-17
19 mm	50		1 SS224-19
22 mm	55		1 SS224-22
24 mm	55		1 SS224-24
27 mm	55		1 SS224-27
30 mm	60		1 SS224-30
32 mm	60		1 SS224-32
34 mm	60		1 SS224-34
36 mm	60		1 SS224-36
41 mm	65		1 SS224-41
46 mm	65		1 SS224-46
50 mm	70		1 SS224-50
55 mm	75		1 SS224-55
60 mm	75		1 SS224-60
65 mm	80		1 SS224-65

Extensión de acero inoxidable



SS234

Ø	L	Icon	Part No.
100 mm			1 SS234-16-100
200 mm			1 SS234-16-200
250 mm			1 SS234-16-250
100 mm			1 SS234-24-100
200 mm			1 SS234-24-200
250 mm			1 SS234-24-250

Junta universal de acero inoxidable



SS236

Ø	L	Icon	Part No.
56 mm			1 SS236-08-80
80 mm			1 SS236-16-80
110 mm			1 SS236-24-110

Mango corregido en T de acero inoxidable



SS238

Ø	L	Icon	Part No.
250			1 SS238-08-250
250			1 SS238-16-250
350			1 SS238-24-350

Berbiquí de acero inoxidable



SS243

Ø	L	Icon	Part No.
300 mm			1 SS243-08
390 mm			1 SS243-16
450 mm			1 SS243-24



Carraca de acero inoxidable



SS242

200 mm	1	SS242-08-200
245 mm	1	SS242-16-245
320 mm	1	SS242-24-320

DESTORNILLADORES

Destornillador de acero inoxidable ERGO™
Para tornillos de cabeza plana



BE-8020i - BE-8252i

3.0	60	5	BE-8020I
3.5	75	5	BE-8030I
4.0	100	5	BE-8040I
5.5	125	5	BE-8241I
6.5	150	5	BE-8252I

Destornillador de acero inoxidable ERGO™
Para tornillos de cabeza Phillips



BE-8600i - BE-8623i

PH 0	60	5	BE-8600I
PH 1	75	5	BE-8610I
PH 2	100	5	BE-8620I
PH 3	150	5	BE-8623I

Destornilladores ERGO™ de acero inoxidable
Para tornillos Pozidriv



BE-8800i - BE-8823i

PZ 0	60	5	BE-8800I
PZ 1	75	5	BE-8810I
PZ 2	100	5	BE-8820I
PZ 3	150	5	BE-8823I

Destornillador de acero inoxidable ERGO™
Para tornillos de cabeza TORX®



BE-8910i - BE-8925i

T 10	75	5	BE-8910I
T 15	100	5	BE-8915I
T 20	100	5	BE-8920I
T 25	125	5	BE-8925I

Juego de 6 destornilladores ERGO™ de acero inoxidable
Para tonillos de cabeza ranurada y Phillips



BE-9881i

6	1	BE-9881I

BE-8020I, BE-8040I, BE-8241I, BE-8252I	
BE-8610I, BE-8620I	

Juego de 6 destornilladores ERGO™ inox.
Para tornillos ranurados y Pozidriv



BE-9882i

6	1	BE-9882I

BE-8020I, BE-8040I, BE-8241I, BE-8252I	
BE-8810I, BE-8820I	

LLAVES ACODADAS

Juego de 13 llaves hexagonales de acero inox.
acodadas serie larga, en pulgadas



BE-9785i

0.05; 1/16; 5/64; 3/32; 7/64; 1/8; 9/64; 5/32; 3/16; 7/32; 1/4; 5/16; 3/8; mm	1	BE-9785I

Llave L con bola de acero inoxidable, mm



SS324

1.5	1	SS324-1.5
2	1	SS324-2
2.5	1	SS324-2.5

3	1	SS324-3
4	1	SS324-4
5	1	SS324-5
6	1	SS324-6
8	1	SS324-8
10	1	SS324-10

Juego de 9 llaves hexagonales con bola inoxidables, serie larga



BE-9770i

1.5; 2; 2.5; 3; 4; 5; 6; 8; 10 mm	20	BE-9770I
-----------------------------------	----	----------

SS324-1.5, SS324-10, SS324-2, SS324-2.5, SS324-3, SS324-4, SS324-5, SS324-6, SS324-8

Llave hexagonal en L con bola, en pulgadas



SS325

5/64" in	1	SS325-2.5
7/64" in	1	SS325-3.5
1/8" in	1	SS325-4
9/64" in	1	SS325-4.5
5/32" in	1	SS325-5
3/16" in	1	SS325-6
7/32" in	1	SS325-7
1/4" in	1	SS325-8
5/16" in	1	SS325-10
3/8" in	1	SS325-12
3/32" in	1	SS325-3

Juego de 13 llaves hexagonales inox. con bola serie larga, pulgadas



BE-9786i

0.05; 1/16; 5/64; 3/32; 7/64; 1/8; 9/64; 5/32; 3/16; 7/32; 1/4; 5/16; 3/8; mm	1	BE-9786I
---	---	----------

SS325-10, SS325-12, SS325-2.5, SS325-3, SS325-3.5, SS325-4, SS325-4.5, SS325-5, SS325-6, SS325-7, SS325-8

PUNTAS PARA ATORNILLAR

Punta Phillips de acero inoxidable para destornilladores de torsión - 25 mm



65I/PH

10	1	1	65I/PH1
2	1	1	65I/PH1-2P
10	2	1	65I/PH2
2	2	1	65I/PH2-2P
10	3	1	65I/PH3
2	3	1	65I/PH3-2P

Punta Pozidriv de acero inoxidable para destornilladores de torsión - 25 mm



65I/PZ

10	1	1	65I/PZ1
2	1	1	65I/PZ1-2P
10	2	1	65I/PZ2
2	2	1	65I/PZ2-2P
10	3	1	65I/PZ3
2	3	1	65I/PZ3-2P

Punta de torsión de acero inoxidable Torx® - 25 mm



65I/T

5	T10	1	65I/T10
2	T10	1	65I/T10-2P

5	T15	1	65I/T15
2	T15	1	65I/T15-2P
5	T20	1	65I/T20
2	T20	1	65I/T20-2P
5	T25	1	65I/T25
2	T25	1	65I/T25-2P
5	T30	1	65I/T30
2	T30	1	65I/T30-2P
5	T40	1	65I/T40
2	T40	1	65I/T40-2P

Caja 5 Adaptadores universales de acero inoxidable de 1/4" Con anilla de retención



KSR753

1	1/4"	1	KSR753-1P
5	1/4"	1	KSR753

-1P: Envase unitario soporte plástico

Juego 6 puntas de acero inoxidable Phillips, Pozidriv, TORX® y adaptador



65I/7

22 x 65 x 75 mm	1	65I/7-1
-----------------	---	---------

65I/PH2	
65I/PZ2	
65I/T15, 65I/T20, 65I/T25, 65I/T30	



ALICATES

Alicate universal de acero inoxidable



SS400

L	
155	1 SS400-160
175	1 SS400-180
200	1 SS400-200

Alicate de corte diagonal de acero inoxidable



SS402

L	
150	1 SS402-160
195	1 SS402-200

Alicate dos posiciones de acero inoxidable
Mango cubierto en PVC



SS412

L	
200	1 SS412-200

Alicates de punta semirredonda de acero inoxidable



SS406

L	
150	1 SS406-160

L	
175	1 SS406-200

Tenacilla articulada de acero inoxidable



SS410

L	
250	1 SS410-250
300	1 SS410-300

Mordaza de acero inoxidable



SS415

L	
255	1 SS415-225

MARTILLOS

Martillo con bola de acero inoxidable



SS506

200	1 SS506-200-FB
300	1 SS506-300-FB
450	1 SS506-500-FB
680	1 SS506-700-FB
900	1 SS506-900-FB
1100	1 SS506-1100-FB

Maza de acero inoxidable



SS502

1000	1 SS502-1000-FB
1500	1 SS502-1500-FB
2000	1 SS502-2000-FB
2500	1 SS502-2500-FB
3000	1 SS502-3000-FB
3600	1 SS502-3600-FB

CINCELES Y PUNTEROS DE CHAPISTA

Palanca de acero inoxidable



SS603

L	
500	1 SS603-15-500
500	1 SS603-19-500
500	1 SS603-20-500
500	1 SS603-23-500
800	1 SS603-23-800
600	1 SS603-25-600
1000	1 SS603-30-1000

Cinzel plano de acero inoxidable



SS610

L	
160	1 SS610-16-160
200	1 SS610-18-200
300	1 SS610-24-300
400	1 SS610-25-400
500	1 SS610-30-500

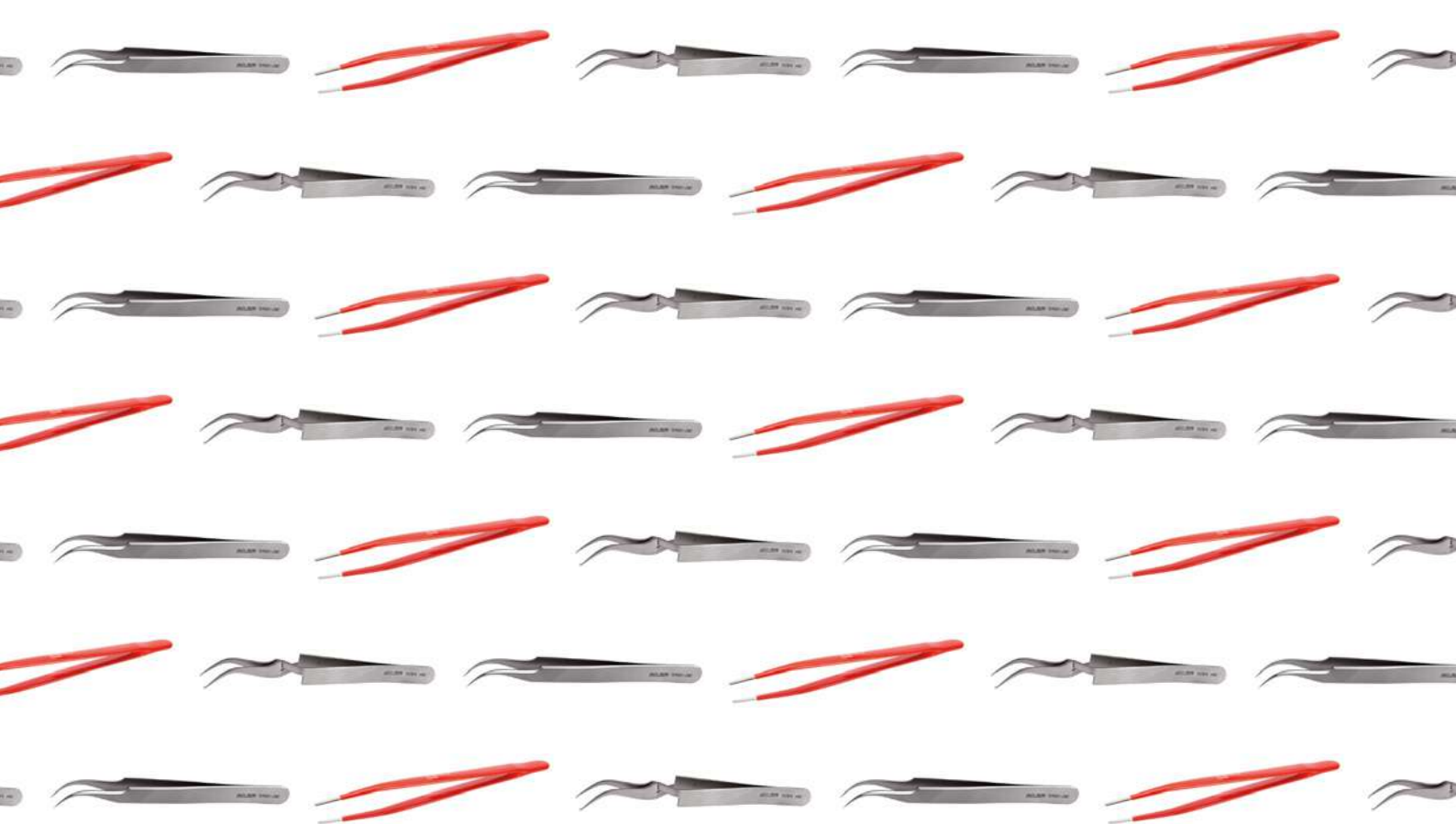

Pinzas y herramientas especiales para electrónica



PINZAS

Pinza universal
Acero especial



5468

112	5	5468-112

Pinza universal
Acero especial



5469

127	5	5469-127
127	5	5469 R
127	5	5469 I

Pinza universal
Acero especial



5469B

120	5	5469 B
120	5	5469 BI
120	5	5469 BR

Pinza de punta puntiaguda
Acero especial



5479

130	5	5479-130

Pinza universal
Acero especial



5471F

120	5	5471 F-120
145	5	5471 F-145
200	5	5471 F-200
250	5	5471 F-250
300	5	5471 F-300
120	5	5471 FI-120
145	5	5471 FI-145
200	5	5471 FI-200
120	5	5471 FR-120
145	5	5471 FR-145

Pinza College
Acero especial



5475R/5475K

150	5	5475 R
100	5	5475 K

Pinza College
Acero especial



5516

150	5	5516
150	5	5516 I

Pinza anti-magnética
Titanio



5463AMT

120	5	5463 AMT

Pinza anti-magnética
Titanio



5465AMT

110	5	5465 AMT

Pinza anti-magnética
Acero inoxidable anti-ácido



5467AM

115	5	5467 AM

Pinza anti-magnética recubierta de PVC
Acero inoxidable anti-ácido



5469AMI

130	1	5469 AMI

Pinza anti-magnética
Titanio



5469AMT

125	5	5469 AMT

Pinza de punta puntiaguda
Acero especial



5517



155
155

5 5517
5 5517 I

Pinza con puntas en cruz
Acero especial



5518



155

5 5518

Pinza de agarre
Acero inoxidable, anti-magnética



5575



145

5 5575-145

Pinza de agarre
Acero inoxidable
Anti-magnética - punta recubierta



5576



145
145

5 5576-145
5 5576-145R

Juego de 7 pinzas
5571-5577



5570/7



115

245

1 5570/7

5571-145

5572-145

5573-145

5574-145

5575-145

5576-145

5577-145

Pinza SDM para electrónica
Acero inoxidable, anti-magnética y anti-ácido



5540AM



120

5 5540 AM

Pinza SDM para electrónica
Acero inoxidable, anti-magnética y anti-ácido



5541AM



120

5 5541 AM

Pinza SDM para electrónica
Acero inoxidable, anti-magnética y anti-ácido



5543AM



120

5 5543 AM

Pinza SDM para electrónica
Acero inoxidable, anti-magnética y anti-ácido



5544AM



115

5 5544 AM

Pinza SDM para electrónica
Acero inoxidable, anti-magnética y anti-ácido



5545AM



120

5 5545 AM

Pinza SDM para electrónica
Acero inoxidable, anti-magnética y anti-ácido



5546AM



120

5 5546 AM



Pinza SDM para electrónica
Acero inoxidable, anti-magnética y anti-ácido



5547AM



120



5 5547 AM

Pinza SDM para electrónica
Acero inoxidable, anti-magnética y anti-ácido



5586AM



115



5 5586 AM

Pinza para electrónica
Acero inoxidable, anti-magnética y anti-ácido



5490AM



115



5 5490 AM

Pinza SDM para electrónica
Acero inoxidable, anti-magnética y anti-ácido



5549AM



120



5 5549 AM

Pinza SDM para electrónica
Acero inoxidable, anti-magnética y anti-ácido



5587GAM



120



5 5587 GAM

Pinza de engastar
Acero inoxidable, anti-magnética



5571



145



5 5571-145

Pinza SDM para electrónica
Acero inoxidable, anti-magnética y anti-ácido



5583AM



115



5 5583 AM

Pinza para electrónica
Acero inoxidable, anti-magnética y anti-ácido



5488AM



115



5 5488 AM

Pinza de engastar
Acero inoxidable, anti-magnética



5572



145



5 5572-145

Pinza SDM para electrónica
Acero inoxidable, anti-magnética y anti-ácido



5584AM



115



5 5584 AM

Pinza para electrónica
Acero inoxidable, anti-magnética y anti-ácido



5489AM



115



5 5489 AM

Pinza de engastar
Acero inoxidable, anti-magnética



5573



145



5 5573-145

Pinza de engastar
Acero inoxidable, anti-magnética



5578



122



5 5578-115

Pinza de engastar
Acero inoxidable, anti-magnética



5579



115



5 5579-115

Pinza SDM para electrónica
Acero inoxidable, anti-magnética y anti-ácido



5588AM



120



5 5588 AM

Pinza SDM para electrónica
Acero inoxidable, anti-magnética y anti-ácido



5589AM



120



5 5589 AM

Pinza SDM para electrónica
Acero inoxidable, anti-magnética y anti-ácido



5590AM



120



5 5590 AM

Juego de pinzas SDM para electrónica
Acero inoxidable, anti-magnética y anti-ácido



5568/5



100



1 5568/5

5489 AM

5583 AM

5589 AM

5584 AM

5546 AM

Pinza de relojero
Acero especial



5463



120

120



5 5463-120

5 5463 R

Pinza de joyero
Acero especial



5470



120

140

160

140

160

140

160



5 5470-120

5 5470-140

5 5470-160

5 5470 R-140

5 5470 R-160

5 5470 I-140

5 5470 I-160

Pinza para bolas
Acero inoxidable, anti-magnética



5484R



145



5 5484 R

Pinza con absorción de calor
Acero inoxidable, anti-magnética - punta/cobre



5577



145



5 5577-145

Pinza de relojero
Acero especial



5464



110

110



5 5464-105

5 5464 R



Pinza de relojero
Acero especial



5465



105



5 5465 R

Pinza de relojero
Acero especial



5467



105



5 5467 R

Pinza cortante
Acero especial



5473



90



5 5473-90

Pinza cortante para electrónica
Acero inoxidable, anti-magnética y anti-ácido



5493



115



5 5493-115

HERRAMIENTAS DE SOLDADURA

Pinza para soldar
Acero especial



5476H



160



5 5476 H

Pinza para desoldar
Acero inoxidable, anti-magnética



5574



145



5 5574-145

Soldadora
Calor inmediato



3250



100



400



1 325001000

1 3250010SH

Punta recambio: 3250010SH

Soldadora para trabajos de industria pesada



322500



30



370



1 322500300

40

375

1 322500500

80

380

1 322500800

Soldador eléctrico, ligero y compacto



32600



18



390



1 326000200

25

420

1 326000300

Soldador con control de temperatura



3270



50



200-500 °C



1 327020500

Soldador eléctrico, robusto y duradero



329500



30



380



1 329500300

40

420

1 329500400

Soldadora para trabajos de industria pesada



329600



50



400



1 329600500

80

410

1 329600800

Puntas de repuesto para soldadora
ST=Recta // ANG=Curvadas



3225

st	1	322510300	
ang	1	322510400	
st	1	322510500	
ang	1	322510600	
ang	1	322510700	
st	1	322510800	

Puntas de repuesto para soldadora



326010

5	1	326010200	
5	1	326020200	
5	1	326030200	

Puntas de repuesto para soldador 3270
SH1=redondo 0,5mm; SH2=plano 2mm; SH3=plano 3mm; SH4=plano 4mm



327020500-SH

0,5mm	1	327020500-SH1	
2mm	1	327020500-SH2	
3mm	1	327020500-SH3	
4mm	1	327020500-SH4	

Puntas de repuesto, forma cincel y lapiz



3295

5	1	329500350	
5	1	329500450	

Puntas de repuesto



3296

10	1	329600100	
10	1	329600200	

Bomba para des-soldar



3280

58	1	328000000	

Soldadura libre de plomo (Sn)
Ø 0.8 mm



3290

2000	1	329000330	
4000	1	329000500	

HERRAMIENTAS PARA MECÁNICA DE PRECISION

Punzones en miniatura, ganchos y picos



2633/

17 x 80 x 150 mm	12	2633/S4	
12 x 12 x 275 mm	12	2633L/S4	

Gancho doble para hilos y muelles



5418

145	1	5418	

Juego de ganchos para hilos y muelles



5419/6T

5 x 78 x 110 mm	1	5419/6T	



Tenedor para desoldar



BE-3529



197

5 BE-3529

Destornillador de ajuste con guía



5550



140

10 5550-3.2

140

5 5550-4.5



Pinza pelacables lacada



2530-32/2530-40



130

5 2530-40

Rasqueta de acero al carbono



2487



210

12 2487

Útiles de sintonización



5551-5554



220

1 5551

205

1 5552

195

1 5553

180

1 5554

Rasqueta triangular



3524



24

1 3524

5

1 3524L-K

Juego de útiles de sintonización



5600/4



75

1 5600/4

Rasqueta triangular



3525HB



168

5 3525HB

Dedo flexible con garras



2509



555

50 2509

Pinza pelacables lacada



2530



605 mm

1 2530

Lupa 10 aumentos



3046-OP



105

12 3046-OP

5551, 5552, 5553, 5554



Medición y trazado



FLEXÓMETROS Y CINTAS MÉTRICAS

Flexómetro



MTS

Longitud (m)	Graduación (mm)	Tipos
5	25	6 MTS-5-25
5	25	6 MTS-5-25-E
8	25	6 MTS-8-25
8	25	6 MTS-8-25-E

E: Pulgadas

Flexómetro clase I



MTB

Longitud (m)	Graduación (mm)	Tipos
5	25	6 MTB-5-25-C1

Flexómetro Bimaterial



MTB

Longitud (m)	Graduación (mm)	Tipos
3	16	6 MTB-3-16
3	16	6 MTB-3-16-M
3	16	6 MTB-3-16-M-E
5	25	6 MTB-5-25
5	25	6 MTB-5-25-M
5	25	6 MTB-5-25-M-E
8	25	6 MTB-8-25
8	25	6 MTB-8-25-M
8	25	6 MTB-8-25-M-E

M: Punta magnética

E: Pulgadas

Flexómetro



MTG

Longitud (m)	Graduación (mm)	Tipos
3	16	12 MTG-3-16
3	16	12 MTG-3-16-E
5	19	12 MTG-5-19
5	19	12 MTG-5-19-E
8	25	4 MTG-8-25
8	25	4 MTG-8-25-E

E: Pulgadas

Flexómetro compacto Clase medición I



MTC

Longitud (m)	Graduación (mm)	Tipos
3	13	6 MTC-3-13-C1
5	16	6 MTC-5-16-C1

Flexómetro compacto clase II



MTC

Longitud (m)	Graduación (mm)	Tipos
3	13	6 MTC-3-13
5	16	6 MTC-5-16

Flexómetro compacto de 3m



MT-TS-3

Longitud (m)	Graduación (mm)	Tipos
3	13	12 MT-TS-3

Cinta métrica de acero con adhesivo
L es para lectura hacia la izquierda, R es para lectura hacia la derecha



BT

Longitud (m)	Graduación (mm)	Tipos
3	13	12 BTR-3-13
6	13	12 BTR-6-13
3	13	12 BTL-3-13
6	13	12 BTL-6-13

Flexómetro



1162N

Longitud (m)	Graduación (mm)	Tipos
3	13	1 1162N-1/2

Cinta métrica larga



LT-STEEL

Length (m)	Length (ft)	Quantity	Model
30	13	5	LT-STEEL-30
50	13	5	LT-STEEL-50

Cinta métrica



LTS

Length (m)	Length (ft)	Quantity	Model
30	16	5	LTS-30
30	16	5	LTS-30-E
50	16	5	LTS-50
50	16	5	LTS-50-E
100	16	5	LTS-100
100	16	5	LTS-100-E

Cinta métrica



LTB

Length (m)	Length (ft)	Quantity	Model
10	13	6	LTB-10
20	13	6	LTB-20
30	13	6	LTB-30

Cinta métrica



LTG

Length (m)	Length (ft)	Quantity	Model
10	10	6	LTG-10
20	13	6	LTG-20
30	13	6	LTG-30

RUEDAS DE MEDICIÓN

Rueda de medición, 150 mm



MW-150

Length (m)	Quantity	Model
150	2	MW-150

Rueda de medición, 250 mm



MW-250

Length (m)	Quantity	Model
940	2	MW-250

REGLAS

Metro plegable 1m de madera de abedul



WR1

Length (m)	Length (ft)	Quantity	Model
1	17	50	WR1
1	17	50	WR1-MM

WR1: mm y pulg WR1-MM: Métrico

Metro plegable 2m de madera de abedul



WR2

Length (m)	Length (ft)	Quantity	Model
2	17	25	WR2
2	17	25	WR2-MM

WR2:mm y pulg WR2-MM: Métrico

Metro 2m plegable 12 secciones mm



WR2-12

Length (m)	Length (ft)	Quantity	Model
2	17	25	WR2-12



Regla flexible de acero inoxidable con clip bolsillo



1179-FLX

160	12	100	1179-FLX

Regla de acero, mm
MM sólo mm



SR

150	19	12	SR150-MM
200	19	12	SR200-MM
300	25	12	SR300-MM
600	30	20	SR600-MM
1000	35	20	SR1000-MM

Producto no disponible para España

Regla de acero, pulgadas
Doble marcado en pulgadas y mm



SR

6	6	12	SR150-E
8	8	12	SR200-E
12	12	12	SR300-E
24	24	20	SR600-E
39	40	20	SR1000-E

NIVELES

Nivel aluminio con asas
M: Magnético



466

400	4	466-400
400	4	466-400-M
600	4	466-600
600	4	466-600-M
800	4	466-800
800	4	466-800-M
1000	4	466-1000
1000	4	466-1000-M
1200	4	466-1200
1200	4	466-1200-M
1800	4	466-1800
2000	4	466-2000

Precisión +/-0,5mm

Nivel
precisión 0.5 mm / m



426

400	1	426-400
600	1	426-600
800	1	426-800
1000	1	426-1000
1200	1	426-1200

Nivel
Precisión 0.5 mm / m



416

400	10	416-400
600	10	416-600
800	10	416-800
1000	10	416-1000
1200	10	416-1200

1500	10	416-1500
1800	10	416-1800
2000	10	416-2000

Nivel de aluminio inyectado
Precisión 0.5mm/m Códigos-M Base magnética



406

300	1	406-300
400	5	406-400
500	5	406-500
600	5	406-600
800	5	406-800

Nivel de poliestireno
Precisión 1.0 mm / m



406P

400	10	406P-400
600	10	406P-600

Juego de 3 niveles
600 mm, 1200 mm, 1800 mm



416-SET-1

3	5	416-SET-1

416-1200, 416-1800, 416-600

Juego de 3 niveles
600 mm, 1200 mm, 2000 mm



416-SET-2

0.029"=0.5mm/m



3

5 416-SET-2

416-1200, 416-2000, 416-600



416-SET-1 + Bolsa de transporte
Bolsa 4750-LV-1



416-SET+BAG



3

1 416-SET+BAG

416-SET-1



4750-LV-1



Nivel
Precisión 1.0 mm / m



486



1800	5	486-1800
2000	5	486-2000
2400	5	486-2400

Nivel
Precisión 1.0 mm/m



486-xxxWH



1800	5	486-1800WH
2000	5	486-2000WH
2400	5	486-2400WH

Nivel de doble perfil
Precisión 0.5 mm / m



496



1500	5	496-1500
1500	5	496-1800

Nivel torpedo de aluminio
3 fiolas, base magnética



426TOR9

0.029"=0.5mm/m



230	10	426TOR9
-----	----	---------

Nivel de andamio
Precisión 0.5 mm / m



466-250

0.029"=0.5mm/m



250	10	466-250
-----	----	---------

Nivel magnético
Tolerancia 1.0 mm / m



406T-225

0.057"=1.0mm/m



228	10	406T-225
-----	----	----------

DISP es un display con 12 unidades

Nivel dos posiciones



466-BE1



20

12 466-BE1

Alineador base magnética
Base magnética



466-LINE



75

12 466-LINE

Nivelador de postes magnético



466-POST



120 x 75 x 80 mm

6 466-POST



MARCADO

Plomada trazadora de magnesio rápida 5:1, 30 m



CL-1441

185	36	CL-1441

Plomada trazadora de magnesio 1:1



CL-1331

185	48	CL-1331

Plomada trazadora triple velocidad de rebobinado CL-1221-SET incluye botella polvo colorante azul 227g



CL-1221

130	6	CL-1221

CL-Line: Línea de trazado de repuesto

Polvo colorante, 227 g



CHALK

227	6	CHALK-BLUE
227	6	CHALK-WHITE
227	6	CHALK-RED
227	6	CHALK-YELLOW

Plomada trazadora CL-1441 + polvo colorante azul



CL-1441-SET

610	16	CL-1441-SET

CL-1441	
CHALK-BLUE	

Plomada trazadora CL-1331 + polvo colorante azul



CL-1331-SET

550	16	CL-1331-SET

CL-1331	
CHALK-BLUE	

Juego de Plomada trazadora, Polvo colorante azul y Nivel de línea



CL-1221-SET

180	4	CL-1221-SET

CHALK-BLUE	
466-LINE	
CL-1221	

Plomada metálica 5m de cuerda



PBS

5	6	PBS-700

Plomada de latón
Peso 227 g / 8 oz



PBB

185 mm	227	6	PBB-8

Lapiz Carpintero grado HB
Certificado FCS.: CERT-0060481



P-HB

175	25	25 P-HB

Display 200 lápices de carpintero
En caja de metal



PENCIL-200

180	200	1 PENCIL-200-DISP

Portaminas de carpintero, dureza HB



P-MEC

150 mm	1	24 P-MEC
100 mm	5	12 P-MEC-LEAD

Puntas de trazar acodadas, 230 mm
Diámetro de 4 mm y ángulo de 70°



1177-SCRIBE

230		5 1177-SCRIBE

Punta de trazar de carburo de tungsteno de 150 mm
Diámetro de 2.5 mm



1178-SCRIBE

150		5 1178-SCRIBE

Punta de trazar con punta de recambio Carbide de 150 mm. Diámetro de la punta 2.5mm, Diámetro del cuerpo 8mm



1179-SCRIBE

150		5 1179-SCRIBE
		1 1179-TIPS

Diam. Punta 2,5mm
Diam. Cuerpo 8mm

ESCUADRAS

Escuadra ajustable



9572

235	115 mm	6 9572-200
250	150 mm	6 9572-250

Escuadra



9574

215	165 mm	10 9574-200
285	170 mm	10 9574-250
300	170 mm	10 9574-300

Escuadra fija



9575

250	110 mm	6 9575-250

Escuadra



9045-B

220	170 mm	6 9045-B-200
250	170 mm	6 9045-B-250
300	170 mm	6 9045-B-300
400	170 mm	1 9045-B-400



Escuadra



9048

L	W	Q	Ref
200	165 mm	10	9048-200
250	165 mm	10	9048-250
300	180 mm	10	9048-300
350	180 mm	10	9048-350
400	180 mm	10	9048-400

Escuadra de albañil



3085

L	W	Q	Ref
400	200 mm	1	308504000
500	250 mm	1	308505000
600	300 mm	1	308506000
800	400 mm	1	308508000
1000	500 mm	1	308510000

Escuadra Combinada



CS

L	W	Q	Ref
150	90 mm	12	CS150
305	125 mm	12	CS300
400	125 mm	12	CS400

Escuadra de carpintero



FCS-600/FCS-1000

L	W	Q	Ref
600	300 mm	6	FCS-600

L	W	Q	Ref
800	300 mm	6	FCS-800
1000	360 mm	6	FCS-1000

Escuadra ajustable para yesista



AS-1200

L	W	Q	Ref
1265	560 mm	3	AS-1200

MEDICIÓN DE PRECISIÓN

Calibre digital de acero inox



1150D

L	W	Q	Ref
150	25 x 90 x 245 mm	1	1150D

Rango de 0 - 150 mm en incrementos de 0.01

Calibre pie de rey



1150

L	W	Q	Ref
150	9 x 75 x 235 mm	1	1150-1/2H/P

Juego de 26 galgas de espesores 0,03 - 1,00 mm



1544

L	W	Q	Ref
100		1	1544

0,03 mm to 0,1 mm in 0,01 mm increments / 0,10 mm to 1,0 mm in 0,05 mm increments

Juego de 13 galgas de espesores 0,05-1,00 mm



1546

L	W	Q	Ref
100		1	1546

Juego de 20 galgas de espesores 0,05 - 1,00 mm



1547

L	W	Q	Ref
100		25	1547

Galgas de roscas de 52 hojas métrico y whitworth 55° 52 hojas



1537

L	W	Q	Ref
0.25-6.0 / 4-62	70	1	1537



Herramientas para albañilería



RASCADORES

Rasqueta ergonómica con funda

ergo®



625

ergo



25

5 625

Rasqueta ergonómica

ergo®



650

ergo



50

5 650

Rasqueta ergonómica

ergo®



665

ergo



60

5 665

Hoja de rasqueta para pintura



850 / 865



50

10 850-1

65

10 865-1

Hojas para rasqueta

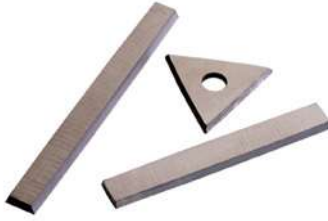

449/442/451



50

10 442-3P

25

10 449

50

10 442

65

10 451

Hojas para rasqueta 625



-625



3

10 625-DROP

3

10 625-PEAR

3

10 625-ROUND

Juego de rasquetas

ergo®



SCRAPER-SET2



50 x 145 x 265 mm

1 SCRAPER-SET2

625



625-DROP, 625-PEAR, 625-ROUND



650



Cuchillo curvo



2488



210

12 2488

Espátula



2489



235

12 2489

Rasqueta de carpintero



474



130

10 474-125-0.60

130

10 474-125-0.80

150

10 474-150-0.60

150

10 474-150-0.80

Espátula con mango de madera riveteado



2155



30

195

12 215500300

40





195

12 215500400

50

195





12 215500500

			
60	215	12	215500600
70	220	12	215500700
80	225	12	215500800
90	230	12	215500900
100	234	12	215501000

Espátula Rígida Mango de Plástico de Acero al carbono







2165

			
30	180	12	216500300
50	180	12	216500500
75	200	12	216500750
100	200	12	216501000

Espátula Mango de Plástico de Acero al Carbono con virola







216





			
30	215	12	216000300
40	215	12	216000400
50	215	12	216000500
60	215	12	216000600
70	215	12	216000700
80	215	12	216000800
90	215	12	216000900
100	215	12	216001000
120	215	12	216001200

Espátula de Acero al Carbono Mango Bi Material



2150





			
30	225	12	215000030
40	225	12	215000040
50	225	12	215000050

			
60	225	12	215000060
70	225	12	215000070
80	225	12	215000080
90	220	12	215000090
100	220	12	215000100
120	220	12	215000120

Espátula Mango Bimaterial - Hoja Inox







2161

			
40	215	12	216100040
60	215	12	216100060
80	215	12	216100080
100	215	12	216100100
120	215	12	216100120

Espátula de emplastecer



2190

			
100 mm	235	5	219001000
120 mm	230	5	219001200
160 mm	245	5	219001400
160 mm	235	5	219001600
200 mm	245	5	219002000

Espátula de emplastecer inoxidable



2192





			
100 mm	235	5	219201000
120 mm	230	5	219201200

			
140 mm	235	5	219201400
160 mm	245	5	219201600
200 mm	235	5	219202000

Espátula de emplastecer inoxidable







2193

			
250		10	219302500
300		10	219303000
350		10	219303500

Espátula de encolar







2212

			
130 mm	120	5	221201200
130 mm	200	5	221202000
130 mm	300	5	221203000

Espátula de encolar



2213

			
130 mm	120	5	221301200
130 mm	200	5	221302000
130 mm	300	5	221303000



HERRAMIENTAS PARA PAREDES DE PLACAS DE ESCAYOLA

Cepillo para achafanar la placa de yeso



250703000



0.3



25 250703000

Pinza especial para colgar tacos metalicos en materiales huecos



250501800



185



50 250501800

Hoja de repuesto para 8640



864000010



20



1 864000010

Elevador de Placas de base cuadrada con ruedas



2504



9000 x 15000 x 15000 mm



1 250400000

Pinza especial para colgar tacos metalicos en materiales huecos



250502450



245



50 250502450

Inglete de repuesto para 864



864000020



20



1 864000020

Set de repuestos elevación (2muelles+freno)



250400010



80



1 250400010

Tijera para ingletes



8640



230



50 864002450

Tijera para Ingletes



8641



245



50 864102400

Hoja de repuesto para 8641



864100010

5	1	864100010

Pinza para unir perfiles sin remache



671002600

260	50	671002600

Pinza para unir perfiles sin remache



671002850

295	50	671002850

HERRAMIENTAS PARA ESCAYOLISTAS

Llana - Rectangular



204

300	150	12	204030150
300	160	12	204030160
300	180	12	204030180
500	130	6	204050130

Llana dentada



209

270	115	12	209027040

Llana dentada



2092

275	115	12	209227060
280	130	12	209228100
500	130	6	209250100

Llana de Acero Inoxidable



2045

300	140	12	204530140
500	130	6	204550130

2045A3000: Hoja afilada

Llana de acero inoxidable para emplastecer



2045A

140	300	12	2045A3000

Llana de Plástico Plana



211

350	180	5	211035180
420	210	5	211042210



Talocha de Plástico base estriada



2120

270	180	5	212027180
330	220	8	212033220

Talocha de Plástico con Punta



213

265	140	5	213026140

Talocha para Soldadores



2122

250	100	10	212202500

Talocha Esponja



2123

140	280	10	212302900

Talocha Goma Dura



2125

220	135	10	212502150

Talocha Goma Blya



2126

140	220	10	212602150
140	280	10	212602800

Guión Yesero de Aluminio



2127

90	435	6	212704350

Carril cuchillas dentadas y rectas



2145xxxD

20 x 45 x 275 mm	1	2145020D0
25 x 45 x 275 mm	1	2145025D0
30 x 45 x 275 mm	1	2145030D0
35 x 45 x 275 mm	1	2145035D0

Carril cuchillas rectas sin dentar



2145xxxL

20 x 45 x 275 mm	1	2145020L0
25 x 45 x 275 mm	1	2145025L0
30 x 45 x 275 mm	1	2145030L0
35 x 45 x 275 mm	1	2145035L0

Carril cuchillas curvas sin dentar



2145xxxC

25 x 45 x 225 mm	1	2145025C0
35 x 45 x 210 mm	1	2145039C0

HERRAMIENTAS PARA ALBAÑILERÍA

Paleta de albañil modelo catalán



2301

145	110	6	2301A0000
160	115	6	2301B0000
175	125	6	2301C0000

Paleta de albañil modelo norte



2302

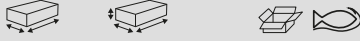

180	110	6	2302A0000
180	100	6	2302B0000
190	125	6	2302C0000

Paleta de albañil modelo Madrid



2303



70	110	6	2303B0000
80	135	6	2303D0000
95	165	6	2303F0000
105	190	6	2303H0000
110	215	6	2303J0000
115	225	6	2303K0000
120	240	6	2303L0000

Paleta de albañil modelo Sevilla



2304

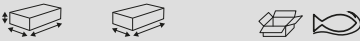

110	180	6	2304A0000
115	200	6	2304C0000

Paletín hoja de laurel



2307

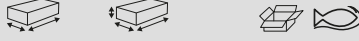

135	60	6	230713500
-----	----	---	-----------

Paletín punta aguda



2308



120	70	6	2308A0000
150	100	6	2308B0000

Paletín punta redonda



2309



125	75	6	230912500
-----	----	---	-----------

Paleta para ángulo externo



2360

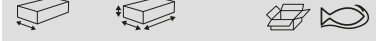

120	97	6	236001200
-----	----	---	-----------

Paleta para ángulo interno



2361



145	165	6	236101200
-----	-----	---	-----------





BAHCO



Sierras manuales



ARCOS DE SIERRA

Arco de sierra para metales - profesional



325

300	5 325

Arco de sierra para metales - profesional



225-PLUS

300	5 225-PLUS

Arco de sierra para metales - profesional



319

300	5 319

Arco de sierra para metales - compacto



317

432	10 317

Arco de sierra para metales - compacto



306

440	10 306

Arco de sierra tradicional



320

504	10 320

Arco de sierra



304

517	10 304

Hoja Sandflex® para sierra compás



321

330	5 321

Sierra universal con doble hoja 300mm/12"



210

360	10 210

Mini arco para metal



268

150	5 268

Mini arco para metal



239

260	5 239

Mini arco para metal



238

150	5	238

Mini-arco para metal



228

150	5	228
150	5	228-BULK

Mini arco para metal



219

291	5	219

Mini arco para metal



218

235	10	218
235	1	218-BULK

Mini arco de sierra para metales



208

330	5	208

HOJAS DE ARCOS DE SIERRA

Hoja de sierra de mano, acero rápido



3905

250	24	100	3905-250-24-100
300	14	100	3905-300-14-100
300	18	100	3905-300-18-100
300	24	10	3905-300-24-2P
300	24	100	3905-300-24-100
300	32	100	3905-300-32-100

Hoja de recambio para mini arco
Revestida com carboneto de tungsténio



215

150	110	1	215-150

Hoja de repuesto para mini-arcos de sierra

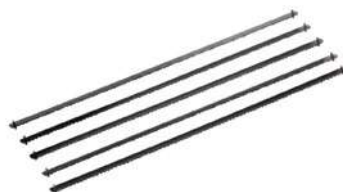

228-P

150	15	10	228-15-5P

150	32	10	228-32-5P
150	32	10	228-32-10P
150	32	1	228-32-100P

Hoja recubierta de carburo de tungsteno



216-R

150	20	1	216-150-R
300	20	1	216-300-R

Hoja con dentado de carburo de tungsteno



3816

300	12	5	3816-300

Hoja Spiro Sandflex® Bi-metal



3806-SPIRO

600	32	10	3806-600-32



Hoja de sierra de mano - para metal
Nueva Sandflex® Bi-metal + Cobalto



3906

L	T	Icono	Icono	Part Number
250	18			3906-250-18-100
250	24			3906-250-24-100
250	32			3906-250-32-100
300	14			3906-300-14-100
300	18			3906-300-18-100
300	24			3906-300-24-100
300	32			3906-300-32-100
300	18-28			3818-300-PROG-100
300	18			3906-300-18-2P
300	24			3906-300-24-2P
300	32			3906-300-32-2P
300	18/24/32			3906-300-3P
250	18			3906-250-18-5P
250	24			3906-250-24-5P
250	32			3906-250-32-5P
300	14			3906-300-14-5P
300	18			3906-300-18-5P
300	24			3906-300-24-5P
300	32			3906-300-32-5P
300	18-28			3818-300-PROG-5P
300	14			3906-300-14-10P
300	18			3906-300-18-10P
300	24			3906-300-24-10P
300	32			3906-300-32-10P

Hoja Sandflex® intercambiable para sierra calar 321
Para sierra compás 321



321-SB

L	T	Icono	Icono	Part Number
310	7			321-7-SB
310	18			321-18-SB
310	24			321-24-SB



Serruchos



SERRUCHOS PARA MATERIALES DE CONSTRUCCION

Serrucho universal



PC-GNP



375 15/16 4 PC-15-GNP

Serrucho universal



300



350 15/16 4 300-14-F15/16-HP

Hoja de serrucho Superior para uso general



EX-16-GNP-C



400 15/16 10 EX-16-GNP-C

Serrucho multiuso



369

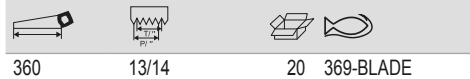

360 13/14 20 369-BLADE

Serrucho de calar superior



3150



300 9/10 4 3150-12-XT9-HP

Serrucho de calar - diente templado



PC-COM



300 9/10 4 PC-12-COM

Serrucho de calar



NP-COM



300 7/8 4 NP-12-COM

Serrucho para placas de escayola



PC-6-DRY



160 8 6 PC-6-DRY

Serrucho para yeso



PC-PLS



600 7/8 4 PC-24-PLS

Hoja de serrucho Superior para escayola



EX-22-PLS-C



550 7/8 10 EX-22-PLS-C

Serrucho para serrar todo tipo de plásticos



PC-22-PLC



550 11/12 4 PC-22-PLC

Serrucho para poliestireno



PC-DECO



400 18/19 4 PC-16-DECO

Arco de metales para cemento poroso y bloques LEKA
Dentado de carburo



255-34

620	1,3	2	255-34

Arco de sierra para cemento poroso y bloques LEKA
Dentado de carburo



255-17/34

620	0,6	2	255-17/34

Serrucho para bloque de hormigón celular



256

650	2	4	256-26

Serrucho para material aislante
PC-22-INS-10P24P : pack de 10/24 pzs



PC-22-INS

550	WT	4	PC-22-INS

SERRUCHOS PARA MADERA

Serrucho - diente templado



PC-GT7

475	7/8	4	PC-19-GT7
550	7/8	4	PC-22-GT7

Serrucho - reafilable



PC-FILE

400	7/8	4	PC-16-FILE-U7
475	7/8	4	PC-19-FILE-U7
550	7/8	4	PC-22-FILE-U7
600	7/8	4	PC-24-FILE-U7

Serrucho - diente templado



NP

400	7/8	4	NP-16-U7/8-HP
475	7/8	10	NP-19-U7/8-HP
550	7/8	10	NP-22-U7/8-HP

Sierra de mano - corte transversal



NP-FLEEM

550	7	10	NP-22-F7/8-HP

Hoja de serrucho Superior Media



EX-XT9

475	9/10	10	EX-19-XT9-C
550	9/10	10	EX-22-XT9-C

Hoja PrizeCut BHS



EX-22-U7

550	7/8	10	EX-22-U7

Prizecut + hoja BHS



EX-NPP-22

550	7/8	10	EX-NPP-22



Serrucho - diente templado

ergo®



2600

475	9/10	4	2600-19-XT-HP
550	9/10	4	2600-22-XT-HP

Serrucho de ranurar superior

ergo®



3240

350	11/12	4	3240-14-XT11-HP

Serrucho Laminator



PC-LAM

500	11/12	4	PC-20-LAM

Serrucho superior
Para material fino y de medio grosor

ergo®



3090

500	11/12	4	3090-20-XT11-HP

Serrucho - diente templado



2500 XT

400	11/12	4	2500-16-XT-HP
475	9/10	4	2500-19-XT-HP
550	9/10	4	2500-22-XT-HP
600	7/8	4	2500-24-XT7-HP

Hoja de serrucho Superior laminator



EX-20-LAM-C

500	11/12	10	EX-20-LAM-C

Serrucho superior para caja de herramientas
Para material medio y fino

ergo®



2600-16

400	11/12	4	2600-16-XT11-HP

Serrucho para el aserrado de madera tamaño medio a grueso



244

500	7/8	10	244-20-U7/8-HP
550	7/8	10	244-22-U7/8-HP

Hoja de serrucho Superior Fina



EX-20-XT11-C

500	11/12	10	EX-20-XT11-C

Serrucho de costilla superior

ergo®



3180

350	11/12	4	3180-14-XT11-HP

Serrucho superior para laminados

ergo®



SUP-LAM

500	11/12	4	SUP-20-LAM

Hoja de serrucho de costilla Superior



EX-14-TEN-C

350	11/12	10	EX-14-TEN-C

Hoja de serrucho Superior para ranurar



EX-14-VEN-C

350	11/12	10	EX-14-VEN-C

Serrucho de costilla - diente templado



PC-TEN

300	11/12	4	PC-12-TEN

Serrucho superior



2700

550	7/8	4	2700-22-XT7-HP
600	7/8	4	2700-24-XT7-HP

Serrucho - diente templado



PC-GT9

475	9/10	4	PC-19-GT9
550	9/10	4	PC-22-GT9

Serrucho de ranurar - diente templado



PC-VEN

300	11/12	4	PC-12-VEN

Serrucho para aglomerados



PC-TIM

600	3.5/4.5	4	PC-24-TIM

Serrucho de precisión



PC-PRC

500	9/10	4	PC-20-PRC

Serrucho de costilla



NP-TEN

300	15/16	10	NP-12-TEN

Serrucho para el aserrado de madera de tamaño medio a grueso



244P

500	7/8	4	244P-20-U7-HP
550	7/8	10	244P-22-U7-HP

Serrucho para caja de herramientas - diente templado



PC-TBX

375	11/12	4	PC-15-TBX

Serrucho de costilla



NP-VEN

300	15/16	10	NP-12-VEN

Hoja de serrucho Superior gruesa



EX-XT7

550	7/8	10	EX-22-XT7-C
600	7/8	10	EX-24-XT7-C



Hoja Barracuda BHS



EX-244P-22

550	7/8	10	EX-244P-22

Ingletes en madera maciza



233

65 x 135 x 300 mm	5	233-300
75 x 135 x 300 mm	5	233-300-A
65 x 135 x 400 mm	5	233-400

Ingletes en madera laminada



234-W

245	53 x 77 x 245 mm	10	234-W1
300	63 x 95 x 300 mm	10	234-W2
300	80 x 100 x 300 mm	10	234-W3

Ingletes en aluminio



234-A

245	55 x 65 x 245 mm	1	234-A1
245	40 x 106 x 245 mm	1	234-A2

SERRUCHOS DE PRECISIÓN

Serrucho de ranurar para cortes extra finos de precisión



PC-11-PS

270	18.5	4	PC-11-19-PS
270	18.5	10	PC-11-19-PS-B

PC-11-19-PS-B: Hoja de recambio

Serrucho de ranurar para carpintería



PC-12-PS

305	13.5	4	PC-12-14-PS
305	13.5	10	PC-12-14-PS-B

PC-12-14-PS-B: Hoja de recambio

Serrucho de ebanista - mango recto



PC-DTR

250	13/14	10	PC-10-DTR

Serrucho de ebanista - mango angulado



PC-DTL

250	13/14	10	PC-10-DTL

Serrucho de ebanista - mango recto



PC-DTF

250	15/16	10	PC-10-DTF

Sierra de doble filo corte fino



PC-9-PS

240	6-8.5 / 17	4	PC-9-9/17-PS
240	6-8.5 / 17	10	PC-9-9/17-PS-B

MANGOS Y AFILADORES

Mango de serrucho ERGO™ para hojas intercambiables
LE=Zurdos



EX-

120 x 330 x 60 mm	4	EX-LL
120 x 330 x 60 mm	4	EX-RM
120 x 330 x 60 mm	4	EX-RL

L: Zurdos; R: Diestros

Afilador Para Serrucho Material Aislante HSS



SHARP-INS

206	100	SHARP-INS

ARCOS Y HOJAS PARA RECORTE

Mini-arco para recorte



301			
165		5	301

5 hojas

Hoja de repuesto para mini-arco 301



303			
165		10	303-5P

HOJAS Y ARCOS DE MARQUETERÍA

Arco de marquetería



302			
130		5	302

Arco de marquetería



502			
130		5	502

Juego de arcos de marquetería



502/			
130		5	502-SET2
500		5	502-SET6

Juego de hojas para mini-arco



302-6X4P			
130		1	302-6X4P

Hojas de repuesto para arcos 202 y 502
Packs de 12 hojas



302M			
1	130	1	302-71M-12P
3	130	1	302-73M-12P
5	130	1	302-75M-12P
7	130	1	302-77M-12P

Hoja de repuesto - madera/plástico: 1: fina
Para serrote de rodear - madeira e plástico



302S			
1	130	1	302-81S-12P
3	130	1	302-83S-12P
5	130	1	302-85S-12P

Hoja de repuesto para arcos de marquetería 302 y 502
Hojas de repuesto para madera y plástico



302W			
1	130	1	302-51W-12P
3	130	1	302-53W-12P
5	130	1	302-55W-12P
7	130	1	302-57W-12P
9	130	1	302-59W-12P
11	130	1	302-511W-12P

SERRUCHO "MUSICAL"

Serrucho musical



296			
750		1	296



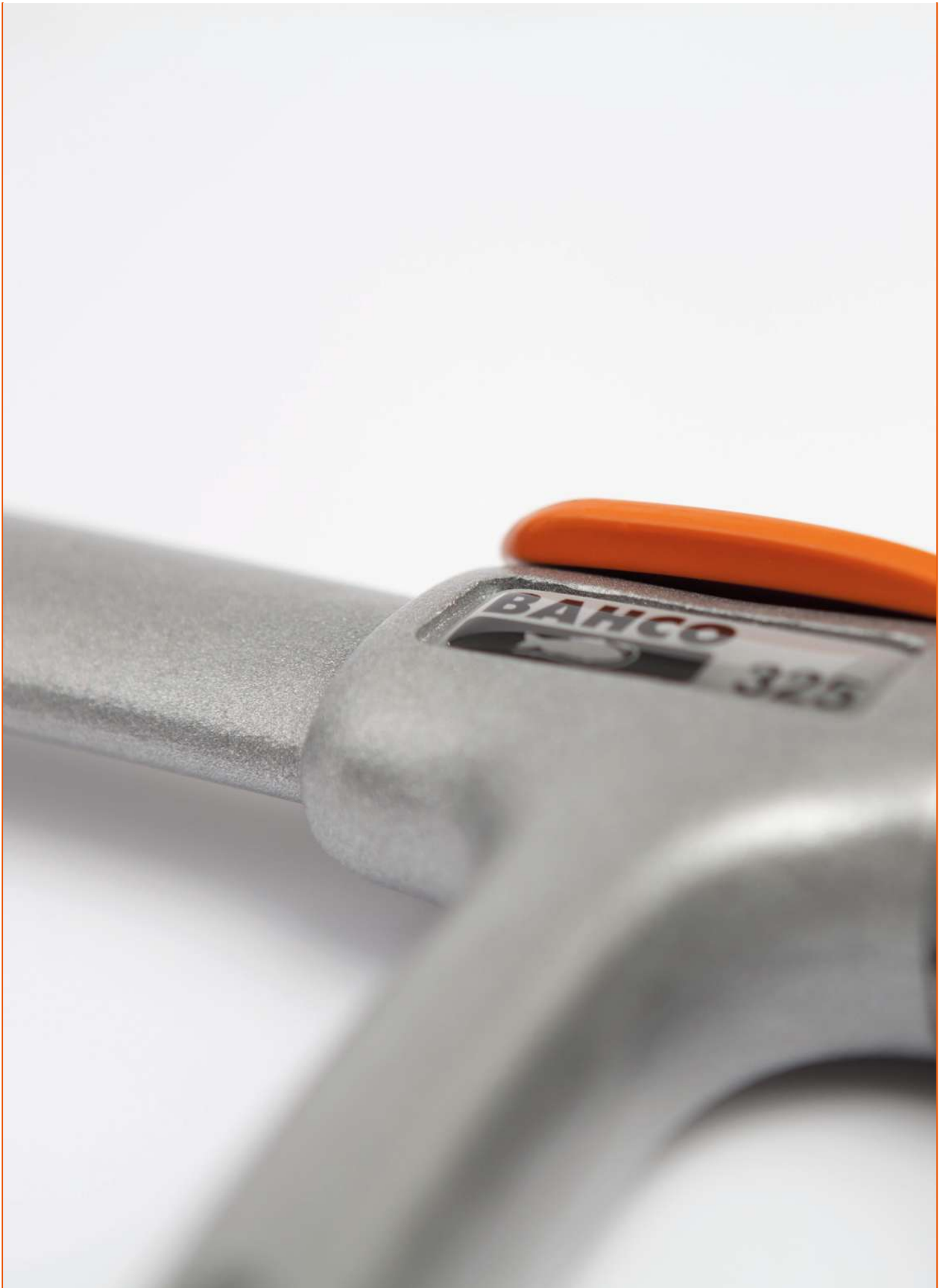

BAHCO



Formones



FORMONES

Formón Ergo™
Adecuado para un uso intensivo con martillo metálico

ergo®



434

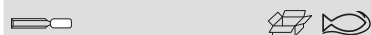

6 mm	4	434-6
8 mm	4	434-8
10 mm	4	434-10
12 mm	4	434-12
14 mm	4	434-14
15 mm	4	434-15
16 mm	4	434-16
18 mm	4	434-18
20 mm	4	434-20
22 mm	4	434-22
25 mm	4	434-25
28 mm	4	434-28
30 mm	4	434-30
32 mm	4	434-32
35 mm	4	434-35
38 mm	4	434-38
50 mm	4	434-50

Adecuado para un uso intensivo con martillo metálico

Juego de 3 formones Ergo™ en caja de cartón
434-S6-EUR: en caja de madera

ergo®



434-S3-EUR



3 12,18,25 mm 1 434-S3-EUR

Adecuado para un uso intensivo con martillo metálico

434-12, 434-18, 434-25

Juego de 6 formones Ergo™ en caja de madera
En caja de madera

ergo®



434-S6-EUR



6 6,10,12,18,25,32 mm 1 434-S6-EUR

Adecuado para un uso intensivo con martillo metálico

434-10, 434-12, 434-18, 434-25, 434-32, 434-6

Juego de 8 formones Ergo™ en caja de madera
Adecuado para un uso intensivo con martillo metálico

ergo®



434-S8-EUR



8 6, 10, 12, 16, 18, 25, 32, 38 mm 1 434-S8-EUR

Adecuado para un uso intensivo con martillo metálico

434-10, 434-12, 434-16, 434-18, 434-25, 434-32, 434-38, 434-6

Juego de 6 formones Ergo™ en bolsa de poliéster
Adecuado para un uso intensivo con martillo metálico

ergo®



434-S6-PP



6 6,10,12,18,25,32 mm 1 434-S6-PP

434-10, 434-12, 434-18, 434-25, 434-32, 434-6

Juego de 6 cinceles ERGO™ en bolsa de cuero



434-S6-LR



1 434-S6-LR

434-10, 434-12, 434-18, 434-25, 434-32, 434-6



Formón profesional con mango bi-componente



424P



4 mm	4	424P-4
6 mm	4	424P-6
8 mm	4	424P-8
10 mm	4	424P-10
12 mm	4	424P-12
14 mm	4	424P-14
15 mm	4	424P-15
16 mm	4	424P-16
18 mm	4	424P-18
20 mm	4	424P-20
22 mm	4	424P-22
24 mm	4	424P-24

	 
25 mm	4 424P-25
26 mm	4 424P-26
28 mm	4 424P-28
30 mm	4 424P-30
32 mm	4 424P-32
35 mm	4 424P-35
38 mm	4 424P-38
40 mm	4 424P-40

Juego de 3 formones con mango bi-material en caja de cartón



424P-S3-EUR

 X		 
3	12,18,25 mm	1 424P-S3-EUR

424P-12, 424P-18, 424P-25 

Juego de 6 formones profesionales con mango bi-material en caja de madera
424P-S6/S8: en caja de madera



424P-S6/S8

 X		 
6	6,10,12,18,25,32 mm	1 424P-S6-EUR

424P-10, 424P-12, 424P-18, 424P-25, 424P-32, 424P-6 

Juego de 6 formones con mango bi-componente en caja de madera



424P-S6-GER



 X		 
6	6,10,12,16,20,26 mm	1 424P-S6-GER

424P-10, 424P-12, 424P-16, 424P-20, 424P-26, 424P-6 

Juego de 8 formones con mango bi-componente en caja de madera



424P-S8-EUR





 X		 
8	6, 10, 12, 16, 18, 25, 32, 38 mm	1 424P-S8-EUR

424P-10, 424P-12, 424P-16, 424P-18, 424P-25, 424P-32, 424P-38, 424P-6 

Juego de 6 formones con mango bi-componente en bolsa de poliéster



424P-S6-PP

 X		 
6	6,10,12,18,25,32 mm	1 424P-S6-PP

424P-10, 424P-12, 424P-18, 424P-25, 424P-32, 424P-6 

Juego de 6 cinceles Professional en bolsa de cuero



424P-S6-LR

 X		 
6	6,10,12,18,25,32 mm	1 424P-S6-LR

424P-10, 424P-12, 424P-18, 424P-25, 424P-32, 424P-6 



Formón con mango de polipropileno



414

Icono de chisla	Icono de caja de cartón	Icono de caja de madera	
6 mm	4		414-6
8 mm	4		414-8
10 mm	4		414-10
12 mm	4		414-12
14 mm	4		414-14
15 mm	4		414-15
16 mm	4		414-16
18 mm	4		414-18
20 mm	4		414-20
22 mm	4		414-22
25 mm	4		414-25
28 mm	4		414-28
30 mm	4		414-30
32 mm	4		414-32
35 mm	4		414-35
38 mm	4		414-38

Juego de 3 formones con mango de polipropileno en caja de cartón
Mango de polipropileno



414-S3-EUR

Icono de caja de cartón	Icono de chisla	Icono de caja de cartón	Icono de caja de madera	
3	12,18,25 mm	1		414-S3-EUR

414-12, 414-18, 414-25

Juego de 5 formones con mango monomaterial rojo, en blister



9883

Icono de caja de cartón	Icono de chisla	Icono de caja de cartón	Icono de caja de madera	
5	6, 12, 16, 20, 25	1		9883

1031-12, 1031-16, 1031-20, 1031-25, 1031-6

Formón con mango monomaterial rojo



1031

Icono de chisla	Icono de caja de cartón	Icono de caja de madera	
4 mm	5		1031-4
6 mm	5		1031-6
8 mm	5		1031-8
10 mm	5		1031-10
12 mm	5		1031-12
14 mm	5		1031-14
16 mm	5		1031-16
18 mm	5		1031-18
20 mm	5		1031-20
22 mm	5		1031-22
25 mm	5		1031-25
28 mm	5		1031-28
30 mm	5		1031-30
32 mm	5		1031-32
40 mm	5		1031-40

Formón con mango de madera



425

Icono de chisla	Icono de caja de cartón	Icono de caja de madera	
4 mm	4		425-4
6 mm	4		425-6
8 mm	4		425-8
10 mm	4		425-10
12 mm	4		425-12
14 mm	4		425-14
15 mm	4		425-15
16 mm	4		425-16

Icono de chisla	Icono de caja de cartón	Icono de caja de madera	
18 mm	4		425-18
20 mm	4		425-20
22 mm	4		425-22
24 mm	4		425-24
25 mm	4		425-25
26 mm	4		425-26
28 mm	4		425-28
30 mm	4		425-30
32 mm	4		425-32
35 mm	4		425-35
38 mm	4		425-38
40 mm	4		425-40

Juego de 3 formones con mango de madera en caja de cartón
425-083: en caja de madera



425-081

Icono de caja de cartón	Icono de chisla	Icono de caja de cartón	Icono de caja de madera	
3	12,18,25 mm	1		425-081

425-12, 425-18, 425-25

Juego de 5 formones con mango de madera en caja de cartón



425-082

Icono de caja de cartón	Icono de chisla	Icono de caja de cartón	Icono de caja de madera	
5	6,10,12,18,25 mm	1		425-082

425-10, 425-12, 425-18, 425-25, 425-6

Juego de 6 formones con mango de madera en caja de madera



425-083

6	6,10,12,18,25,32 mm	1 425-083

425-10, 425-12, 425-18, 425-25, 425-32, 425-6

Mango de repuesto para formones 1031



956

108	50	1 956

CINCELES GUBIA

Gubias profesionales con mango bi-componente



422P

6 mm	4 422P-6
10 mm	4 422P-10
12 mm	4 422P-12
16 mm	4 422P-16
20 mm	4 422P-20
25 mm	4 422P-25

CINCELES DE DEMOLICIÓN

Cuchillo formón
SB-2448 en blíster, 2448 Display de 12 piezas



2448

25 mm	231	12 2448
25 mm	240	12 SB-2448

Display 12 uds
SB-2448 versión para colgar

Cuchillo alta resistencia hoja curvada caja expositora
12 uds
SB: blister, 2449 Display de 12 piezas



2449

25 mm	240	12 2449
25 mm	231	10 SB-2449

SB: Versión para colgar 2449: Display 12 uds

ACCESORIOS PARA FORMONES

Piedra de afilado natural



528-700

150	1 528-700

Piedra de afilado - 2 granos



528-COM

150	1 528-COM

Kit de afilado de cinceles para madera



529-SK

220 x 10 x 170 mm	650	1 529-SK

Funda protectora de plástico
Con clip para colgar en el cinturón



WC-HOL

292 mm	1 WC-HOL





BAHCO



Tijeras y cuchillos



TIJERAS CORTACHAPAS

Tijera para chapa
Tipo aviación, corte recto



MA225



250



4 MA225

Tijera para chapa
Tipo aviación, corte a izquierda y recto



MA225L



250



4 MA225L

Tijera para chapa
Tipo aviación, corte a derecha y recto



MA225R



250



4 MA225R

Tijera cortachapa articulada, corte izquierda



MA401



250



10 MA401
1 8698M0250

8698M0250: Juego de piezas de repuesto
(tornillo, muelle y husillo)

Tijera cortachapa articulada, corte derecha



MA411



250



10 MA411

8698M0250: Juego de piezas de repuesto
(tuerca, muelle y husillo)

Tijera cortachapas articulada, corte recto



MA421



250



10 MA421

8698M0250: Juego de piezas de repuesto
(tuerca, muelle y husillo)

Tijera cortachapas multiuso, corte largo



MA431



290



1 MA431

0.53mm acero inox
0.94mm laminado en frío

Tijera cortachapas articulada profesional, corte izquierda



MA311



260



10 MA311
1 8697M0260

0.9mm acero inox
1.5mm laminado en frío

Tijera cortachapa articulada profesional, corte derecha



MA321



260



10 MA321

0.9mm acero inox
1.5mm laminado en frío

Tijera para chapa
Tipo aviación, corte recto



MA325



250



4 MA325

Tijera para chapa tradicional
Corte recto



MR340



340



2 MR340

Tijera cortachapa articulada, corte derechas



MA361



260



10 MA361

1mm acero inox
1.5mm laminado en frío

Tijera cortachapas articulada profesional, corte izquierda



MA351

250	10	MA351

1mm Acero inox
2mm Laminado en frío

Tijera para chapa tradicional
Corte recto



M126

260	4	M126

Tijera para chapa tradicional
Corte a izquierdas y recto



M227L

270	4	M227L

0.6mm Acero inox
1.2mm Acero laminado

Tijera para chapa tradicional
Corte a derecha y recto



M227R

270	4	M227R

Tijera para chapa tradicional
Corte recto



M330

11 3/4	4	M330

Tijera para chapa tradicional



M526

260	4	M526

Tijera para chapa tradicional
Corte recto - 1 hoja fina y 1 hoja ancha



M730

220	4	M722
260	4	M726
300	2	M730

Tijeras para chapa modelo Catalán



8692

300 mm	6	869203000

Tijera para chapa tradicional
Corte recto



MR126

260	4	MR126

Tijera para chapa tradicional
Corte a izquierdas y recto



MR227L

270	4	MR227L

Tijera para chapa tradicional
Corte a derecha y recto



MR227R

270	4	MR227R



Tijera para chapa tradicional
Corte recto - 1 hoja fina y 1 hoja gruesa



MR726

260	4 MR726

Tijera para chapa tradicional
Corte a derecha y recto



583D

280	4 583D

Tijera para chapa tradicional
Corte a derecha y recto



584D

280	4 584D

Tijera para chapa tradicional
Corte a derecha y recto



585D

280	4 585D

Tijera para chapa tradicional
Corte a izquierda y recto



586D

280	4 586D

Tijeras para chapa de dos manos



M6376

760	1 M6376 1 M6376-SH

Tijera para chapa de dos manos
Con multiplicador



M676

760	1 M676 1 M676-SH

SH: Cuchilla repuesto

Tijeras para chapa - cizalla



M926

250	1 M926 1 M926-SH

SH: Cuchilla repuesto

Tijera multi-uso



2744

190	6 2744

TIJERAS

Tijera de electricista
S= versión serrada



SC127/SC127S

45 mm	130	10 SC127
45 mm	127	10 SC127S

S= Con corte dentado

Tijera de electricista
c= versión curva



SC140/SC140C

50 mm	145	10 SC140
50 mm	145	10 SC140C

C=Curva

Tijera de electricista, modelo extra fuerte



SC150NG



38 mm 155 10 SC150NG

Tijera especial para agarrar



2705R



160 1 2705R

Cutter retráctil



KBRU-01



170 26 mm 5 KBRU-01

Tijera electricista 140mm



SCB140

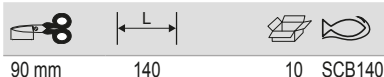

90 mm 140 10 SCB140

CUCHILLOS

Cutter retractil ERGO™



KERU-01



170 26 mm 5 KERU-01

Cutter retráctil



KGRU-01

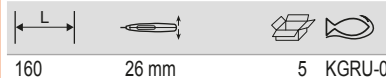

160 26 mm 5 KGRU-01

Tijera electricista 140mm acanalada



SCB140G



43 mm 140 10 SCB140G

Cutter retractil ERGO™

Cutter ERGO™



KEFU-01

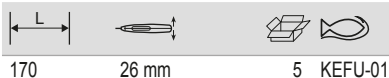

170 26 mm 5 KEFU-01

Cutter retráctil



KGRU-02



145 26 mm 5 KGRU-02

Tijera especial corta para estaño



2704



110 1 2704A

Cutter ERGO™ hoja seccionable 18mm



KE18-01



161 26 mm 5 KE18-01

Cutter mini retráctil



KMU-01

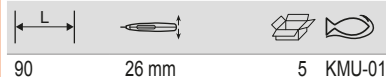

90 26 mm 5 KMU-01



Cutter de hoja deslizante



SQZ150003

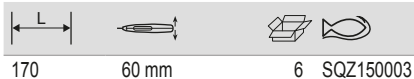

Dispensador hojas trapezoidales, 5 piezas



KBGU-5P-DISPEN



Hojas de recambio



SQZ150003-SBL



Hojas de recambio para cutter universal

Cutter cuchilla fija



KBFU-01



Dispensador con 10 hojas trapezoidales



KBGU-10P-DISPEN



Hojas de recambio



SQZ150003-HSBL



Hojas de recambio en forma de gancho para cutter universal

Cutter cuchilla fija



KGFU-01



Dispensador hojas gancho, 5 piezas



KBGH-5P-DISPEN



Cutter hoja seccionable ABS mango TPR 9 mm



KB09-01



Hojas para cutter



KBGU



Dispensador hojas seguridad, 5 piezas



KBGR-5P-DISPEN



Cutter hoja seccionable 18mm TPR



KB18-01



Cutter hoja seccionable 9 mm



KG09-01

140	5	KG09-01
140	10	KG09-01-3P

Pack de 5 hojas no seccionables 18 mm



KUBG

0.7 x 85 x 9 mm	60	KUBG09-5P
1 x 110 x 18 mm	20	KUBG18-5P

Soporte para navaja



KHU-01

90	4	KHU-01

Cutter hoja seccionable 18mm



KG18-01

160	5	KG18-01

Dispensador hojas Snap Off 18mm, 5 piezas



KUBG18-5DISPEN

15 x 30 x 130 mm	20	KUBG18-5DISPEN

Mini cutter multi usos



SQZ-MINI

160	24	SQZ-MINI

Dispensador hojas Snap Off 9mm, 5 piezas



KUBG09-5DISPEN

15 x 20 x 100 mm	20	KUBG09-5DISPEN

Dispensador con 10 hojas de 18 mm



KSBG18-10DISPEN

15 x 30 x 130 mm	20	KSBG18-10DISPEN

Dispensador cuchillas mini cutter



SQZ-MINI-BLADE

28 mm	1	SQZ-MINI-BLADE

Dispensador 10 hojas Snap Off 9 mm



KSBG09-10DISPEN

1 x 9 x 85 mm	20	KSBG09-10DISPEN

Cuchillo de seguridad



KGAU-01

160	5	KGAU-01

Navaja doble hoja mango de aluminio



KBTU-01

160	20 mm	5	KBTU-01



Navaja hoja fija 3 pulgadas



KBSK-01



170



5 KBSK-01

Navaja para electricista, plegable, mango de madera



2820EF1



90 mm



12 2820EF1

Cuchillo electricista



2446-EL



32 mm



12 2446-EL

Navaja hoja intercambiable



KBSU-01



160



5 KBSU-01

Navaja para electricista, plegable, mango de plástico



2820EF2



85 mm



12 2820EF2

Cuchillos pelacables de electricista - uso mano derecha
Para zurdos



2446-ELL



34 mm



12 2446-ELL

Navaja hoja intercambiable mango poliamida



KGSU-01



160



5 KGSU-01

Navaja para electricista, plegable, mango de plástico



2820EF3



80 mm



1 2820EF3

Cuchillo pelacables para electricista - Para diestros
Uso para diestros



2446-ELR



34 mm



12 2446-ELR

Navaja de electricista



2820EK



95 mm



6 2820EK

Navaja para electricista, plegable, mango de plástico
Doble hoja



2820EF4



75-85 mm



1 2820EF4

Cuchillo de electricista con funda



2446-EL-HELP



43 mm



12 2446-EL-HELP

BAHCO

Cuchillo punzón electricista



2820EK-01



25 mm 12 2820EK-01

Cuchillo Laplander



2444-LAP

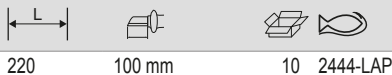

220 100 mm 10 2444-LAP

Cuchillo para lino



2446-LINO



180 55 mm 12 2446-LINO

Cuchillo mango robusto bi-componente, en blister



SB2446-EL

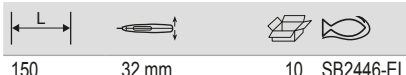

150 32 mm 10 SB2446-EL

Cuchillo multiuso con hoja de acero inoxidable



SB-2444

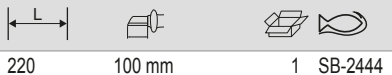

220 100 mm 1 SB-2444

Cuchillo robust multiusos
Colgador especial



2446-OV



220 100 mm 15 2446-OV

Cuchillo multiuso con hoja de acero inoxidable
Funda especial con botón doble



1446



220 15 1446

Cuchillo multiuso con hoja de acero inoxidable
Longitud total del producto 220 mm, longitud de la hoja 100 mm



2446

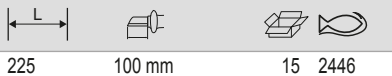

225 100 mm 15 2446

Cuchillo robusto mango bi-componente



2444



220 100 mm 15 2444

Cuchillo robusto multiusos
Colgador especial



1446-OV

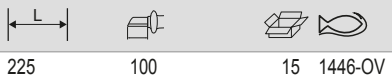

225 100 15 1446-OV

Multiherramienta



MTT151



150 6 MTT151

Incluye funda protectora. El precio es unitario.



Multiherramienta con llavero



MTT121



110



8 MTT121

Raspador ventanas cuerpo de metal



KRSS-01



80



10 KRSS-01

Multi herramienta 12 en 1 cuerpo de aluminio



MTT051



165



6 MTT051

Rasqueta de ventanas, cuerpo de plástico bicomponente



KBWS-01



70



10 KBWS-01



Mordazas y tornillos de banco

MORDAZAS

Mordaza Rápida



QCB

L		
456	6	QCB-150
606	6	QCB-300
756	6	QCB-450
906	4	QCB-600
1206	4	QCB-900
1556	8	QCB-1250

Mordaza Rápida



QCG

L		
380	6	QCG-150
530	6	QCG-300

Mordaza rápida



QC

L		
482 mm	6	QC-300A

Mordazas



3066

L			
405	90 mm	5	306601500
300	90 mm	5	306602000
355	90 mm	5	306602500
260	90 mm	5	306603000
510	90 mm	5	306604000

Mordazas



3067

L			
360	125 mm	5	306702500
415	125 mm	5	306703000
510	125 mm	5	306704000
610	125 mm	5	306705000
710	125 mm	5	306706000
910	125 mm	5	306708000
1115	125 mm	5	306710000
1310	125 mm	2	306712000
1610	125 mm	2	306715000

Mordazas



3068

L			
430	155 mm	5	306803000
535	155 mm	5	306804000
640	155 mm	2	306805000
730	155 mm	2	306806000
820	155 mm	2	306808000
1135	155 mm	2	306810000
1335	155 mm	2	306812000
1630	155 mm	1	306815000
2130	155 mm	1	306820000

Mordazas



3069

L			
430	225 mm	2	306903000
540	225 mm	2	306904000
638	225 mm	2	306905000
730	225 mm	2	306906000
932	225 mm	2	306908000
1130	225 mm	2	306910000

Mordaza con mango de plástico



420SH

L			
100	50 mm	10	420SH-50-100
200	50 mm	10	420SH-50-200
120	60 mm	12	420SH-60-120
300	60 mm	12	420SH-60-300
160	80 mm	12	420SH-80-160
200	100 mm	10	420SH-100-200
250	120 mm	8	420SH-120-250
300	120 mm	8	420SH-120-300
400	120 mm	6	420SH-120-400
500	120 mm	6	420SH-120-500
600	120 mm	6	420SH-120-600
800	120 mm	6	420SH-120-800
1000	120 mm	6	420SH-120-1000
1250	120 mm	6	420SH-120-1250
1500	120 mm	6	420SH-120-1500
400	140 mm	6	420SH-140-400
400	175 mm	6	420SH-175-400

Mordaza muelle



420SC

60	10	420SC-25
120	5	420SC-50

TORNILLOS DE BANCO

Tornillo de banco, guía cuadrada



834V

100	1	834V-4
125	1	834V-5
150	1	834V-6
175	1	834V-7

Tornillo lateral para regular la holgura
Mordaza 6072M y husillo 6070H

Tornillo de banco, guía cuadrada



6072

100	1	607201000
125	1	607201250
150	1	607201500
175	1	607201750

Compatible con base giratoria 833SB

Tornillo de banco, guía redonda



6010

80	1	601000800
100	1	601001000
125	1	601001250
150	1	601001500

Compatible con base giratoria 833SB
Mordaza y husillo de repuesto 6010M y 6010H

Tornillo de sobremesa



834V-2

63	1	834V-2

Mordazas con tornillos de repuesto para tornillo de banco 6072



6072M

100	1	6072M1000
125	1	6010M1250
150	1	6072M1500
175	1	6072M1750

Mordaza para tubos



833P

100	1	833PJ-4
125	1	833PJ-5
150 / 175	1	833PJ-67

Husillo de repuesto para tornillo de banco 6072



6070H

100	1	6070H1000
125	1	6070H1250
150	1	6070H1500
175	1	6070H1750

Mordazas de repuesto para tornillo de banco 6010



6010M

80	1	6010M0800
100	1	6010M1000
150	1	6010M1500



Husillo y tuerca de repuesto para tornillo 6010



6010H

Diagram	Icon	Quantity	Part Number
		1	6010H0800
		1	6010H1000
		1	6010H1250
		1	6010H1500

Mordazas de aluminio



833AJ

Diagram	Icon	Quantity	Part Number
		1	833AJ-4
		1	833AJ-5
		1	833AJ-6

Mordazas y husillos de repuesto para tornillo de banco 834V-2



6040M/H

Diagram	Icon	Quantity	Part Number
		1	6040M0630

Mordazas de fibra

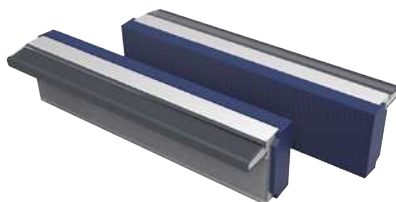

833FJ

Diagram	Icon	Quantity	Part Number
		1	833FJ-4
		1	833FJ-5
		1	833FJ-6

ACCESORIOS PARA TORNILLOS DE BANCO

Base giratoria para 6010,6072 y 834V



833SB

Diagram 1	Diagram 2	Icon	Quantity	Part Number
			1	833SB-4
			1	833SB-5
			1	833SB-6
			1	833SB-7



Martillos



MARTILLOS DE CARPINTERO

Martillo Carpintero ERGO™

ergo®



529

ergo

450	4	529-16-L
450	4	529-16-XL
570	4	529-20-L
570	4	529-20-XL

Martillo de carpintero ERGO™

ergo®



529S

450	4	529S-16-XL
570	4	529S-20-XL

Martillo de carpintero, mango madera



427

700	6	427-700

Martillo de carpintero, mango fibra de vidrio



428

700	6	428-700

Martillo de carpintero



429

230	4	429-8
370	4	429-13
450	4	429-16
570	4	429-20

Martillo de carpintero



428

370	4	428-13
450	4	428-16
570	4	428-20

Martillo de carpintero



427

450	4	427-16
570	4	427-20

EXTRACTORES DE CLAVOS

Extractor de clavos con mango de agarre cómodo de plástico termoinyectado



36

220	5	36

Muelle interior patentado

Extractor de clavos



38

450	1	38

MARTILLOS DE MECÁNICO

Martillo Warrington



480

230	4	480-08
280	4	480-10
340	4	480-12
400	4	480-14
570	4	480-20

Martillo de cerrajero - tipo alemán DIN



481

Icono	Icono	
100	6	481-100
200	6	481-200
300	6	481-300
400	6	481-400
500	6	481-500
800	6	481-800
1000	6	481-1000
1500	6	481-1500
2000	6	481-2000

Martillo para ribete - tipo francés



482

Icono	Icono	
300	6	482-25
400	6	482-28
500	6	482-30
800	6	482-35
1000	6	482-40
1500	6	482-45

Martillo de bola



492

Icono	Icono	
100	4	492-3.5

Martillo de bola



479

Icono	Icono	
230	6	479-08
340	6	479-12
450	6	479-16
570	6	479-20
800	6	479-24
900	6	479-32

MARTILLOS PARA CONSTRUCCIÓN

Martillo de carpintero



485

Icono	Icono	
600	4	485

Martillo de carpintero
SH-485W: Mango de cuña de repuesto, SH-485W-PLATES: railes de repuesto



485W

Icono	Icono	
650	4	485W-650
750	4	485W-750
	1	SH-485W
	1	SH-485W-PLATES

Martillo de ebanista



483

Icono	Icono	
100	6	483-16
160	6	483-20
200	6	483-22
300	6	483-25
400	6	483-28
500	6	483-30

Martillo inglés



490

Icono	Icono	
100	4	490-3.5

Maceta



484

Icono	Icono	
1000	6	484-1000
1250	6	484-1250
1500	6	484-1500
2000	6	484-2000



Maceta de albañil



407

700	6	407-700
1000	6	407-1000
1400	6	407-1400

Maceta mango fibra de vidrio



407F

700	6	407F-700
1000	6	407F-1000
1400	6	407F-1400

Maza cuadrada, mango madera
Mangos de madera



488

2000	2	488-2000
3000	2	488-3000
4000	2	488-4000
5000	2	488-5000
6000	1	488-6000

Maza cuadrada, mango fibra de vidrio
Mango de fibra de vidrio



488F

2000	2	488F-2000
3000	2	488F-3000
4000	2	488F-4000
5000	2	488F-5000
6000	2	488F-6000

Martillo de albañil
SH-486W: Mango de cuña de repuesto



486W

500	4	486W-500
600	4	486W-600
	1	SH-486W

Piqueta 700g, mango madera



486-700

700	6	486-700

Piqueta 700g, mango fibra de vidrio



486F

700	6	486F-700

Martillo de albañil



486

600	4	486

Fijas de albañil



4401



255	10	440102500
300	10	440103000

Mangos de madera de repuesto





WSH

491-3000 & 491-4000	12	SH-407
	12	SH-491-34
	12	SH-491-56
488-2000	10	SH-488-2000
488-3000, 488-4000	10	SH-488-34

	 
488-5000, 488-6000	10 SH-488-56
427-700	10 SH-427-700
486-700, 495-500, 495-600, 493-500, 493-600	10 SH-486-493-495

Mangos de fibra de vidrio de repuesto





	 
488f-2000	10 SH-488f-2000
488f-3000 & 488f-4000	1 SH-488f-34
488f-5000 & 488f-6000	1 SH-488f-56
428-700	10 SH-428-700
486f-700, 495f-500, 495f-600, 493f-500, 493f-600	10 SH-486f493f495f

MARTILLOS ESPECIALES



Alcotana pala-hacha, mango madera



	 
500	6 493-500
600	6 493-600



Alcotana pala-hacha, mango fibra de vidrio



	 
500	6 493f-500
600	6 493f-600



Alcotana pala-pico, mango madera



	 
500	6 495-500
600	6 495-600



Alcotana pala-pico, mango fibra de vidrio



	 
500	6 495f-500
600	1 495f-600

Martillo hacha





		 
600	830	4 494-600

MARTILLOS SLEDGE



Martillo anti-rebote
Boca de poliuretano (PU)



	 
550	6 3625AR-35
1430	6 3625AR-50
1550	6 3625AR-60





Martillo anti-rebote



	 
300	12 3625PU-30
790	6 3625PU-50
1080	6 3625PU-60

Martillo anti-rebote



		 
5000	5600	1 3625PU-105



Maza con pico
Cabeza cuadrada



491

3000	4	491-3000	
4000	4	491-4000	
5000	4	491-5000	
6000	4	491-6000	

Mango irrompible



489-1100/489-1800

1100	1	489-1100	
1800	1	489-1800	

Maza de seguridad



489-2700/489-5400

2700	1	489-2700	
3600	1	489-3600	
4500	1	489-4500	
5400	1	489-5400	

MARTILLOS Y MAZAS BLANDOS

Martillo de plástico Polyflex
LY: cabezas de repuesto



3625Y

g		
150	1	3625Y-22
240	1	3625Y-27
340	1	3625Y-32
430	1	3625Y-35
570	1	3625Y-40
930	1	3625Y-50
1270	1	3625Y-60

Par de bocas de repuesto para 3625Y



3625YL

3625Y-22	22 mm	1 3625YL-22
3625Y-27	27 mm	1 3625YL-27
3625Y-32	32 mm	1 3625YL-32
3625Y-35	35 mm	1 3625YL-35
3625Y-40	40 mm	1 3625YL-40
3625Y-50	50 mm	1 3625YL-50
3625Y-60	60 mm	1 3625YL-60

Martillo de plástico Superflex
NL: cabezas de repuesto



3625N

g		
170	5	3625N-22
250	5	3625N-27
333	5	3625N-32
440	5	3625N-35
560	5	3625N-40
900	1	3625N-50
1200	1	3625N-60

Par de bocas de repuesto para 3625N



3625NL

3625N-22	22 mm	1 3625NL-22
3625N-27	27 mm	1 3625NL-27
3625N-32	32 mm	1 3625NL-32
3625N-35	35 mm	1 3625NL-35
3625N-40	40 mm	1 3625NL-40
3625N-50	50 mm	1 3625NL-50
3625N-60	60 mm	1 3625NL-60

Maza mango madera, boca de nylon
WL puntas de repuesto, mango de repuesto WLH



3625W

g		
150	6	3625W-22
250	6	3625W-28
490	6	3625W-35
1050	6	3625W-44
1470	6	3625W-55

WL: Tacos de recambio
WLH: Mango de repuesto

Par de bocas de repuesto para 3625W y 3625S





3625WL

3625W-22	22 mm	10 3625WL-22
3625W-28, 3625S-28	28 mm	10 3625WL-28
3625W-35, 3625S-35	35 mm	10 3625WL-35
3625W-44, 3625S-44	44 mm	10 3625WL-44
3625W-55	55 mm	6 3625WL-55

Martillo boca nylon - Mango de acero





3625S

g		
350	6	3625S-28
610	6	3625S-35
1100	6	3625S-44

Maza de goma negra





3625RM

g		
290	1	3625RM-55
460	1	3625RM-65
660	1	3625RM-75
850	1	3625RM-90

Maceta de cobre



4130

	
500	6 413005000
1000	6 413010000
1500	6 413015000
2000	6 413020000
3000	1 413030000
4000	1 413040000





BAHCO



Herramientas forestales y de tala de árboles



HACHAS, ALCOTANAS Y MAZAS

Hachas con mango de madera



HUS

Longitud (mm)	Peso (g)	Paquetes	Modelo
380	830	4	HUS-0.6-380
500	1030	4	HUS-0.8-500

Hacha tipo Alemán



HGPS

Longitud (mm)	Peso (g)	Paquetes	Modelo
360	810	10	HGPS-0.6-360
380	930	4	HGPS-0.8-380
400	1180	4	HGPS-1.0-400

Hacha camping con mango de composite



CUC

Longitud (mm)	Peso (g)	Paquetes	Modelo
360	640	4	CUC-0.4-360

Hachas con mango de madera



HUS-1.0-650

Longitud (mm)	Peso (g)	Paquetes	Modelo
650	1610	4	HUS-1.0-650

Hacha ligera con mango de composite



CUC-0.8-600

Longitud (mm)	Peso (g)	Paquetes	Modelo
600	1220	4	CUC-0.8-600

Hacha con mango en fibra de vidrio



HFGPS

Longitud (mm)	Peso (g)	Paquetes	Modelo
380	1010	4	HFGPS-0,7-400FG

Hacha tipo Alemán



FGS-810

Longitud (mm)	Peso (g)	Paquetes	Modelo
800	2230	4	FGS-1.6-810
800	2480	4	FGS-1.8-810

Hacha tipo Canadiense, mango de nogal



FCP

Longitud (mm)	Peso (g)	Paquetes	Modelo
800	2540	4	FCP-1.8-810
850	3000	2	FCP-2.3-860

Hacha tipo Alemán



FGS

Longitud (mm)	Peso (g)	Paquetes	Modelo
600	1330	4	FGS-1.0-600
700	1850	4	FGS-1.25-700

Hacha con mango en fibra de vidrio



FFSS

Longitud (mm)	Peso (g)	Paquetes	Modelo
900	2400	4	FFSS-1.5-900FG

Hacha



SUS

Longitud (mm)	Peso (g)	Paquetes	Modelo
800	2660	4	SUS-2.0-800

Hacha tipo Canadiense, Mango de nogal



MCP

Longitud (mm)	Peso (g)	Paquetes	Modelo
800	3300	2	MCP-2.5-810

Hacha rompedora con mango de composite



SUC

L	g	Icon	Model
450	980		4 SUC-0.7-450
600	1310		4 SUC-0.9-600
710	1550		4 SUC-1.0-710
780	2300		4 SUC-1.7-800

L	Icon	Model
915		12 SH-MES-900FG
800		12 SH-SUS-800
800		1 SH-MCS-800
905 mm		1 SH-FCP-860

FB: Fibra Vidrio

Hacha



LS/MES

L	g	Icon	Model
900	3270		2 LS-MERLIN-2.5
900	3330		2 LS-MERLIN-2.5FG
900	3620		2 MES-3.0-900

FG: Fibra de vidrio

Hacha rompedora



MES

L	g	Icon	Model
900	3880		2 MES-3.5-900
900	4310		2 MES-3.5-900FG

Pico de hacha



PAGS-2.0-900FG

L	g	Icon	Model
900	3000		1 PAGS-2.0-900FG

Picos



PAGS

L	g	Icon	Model
450	2000		6 PAGS-2.0

Mangos de repuesto para pico de hacha



SH-PAGS

L	g	Icon	Model
900	690		1 SH-PAGS-900
920	1030		1 SH-PAGS-900FG

CUÑAS

Cuñas de Tumba



LS-COIN

L	g	Icon	Model
260	295		2 LS-COIN 26 CM
190	170		4 LS-COIN 19 CM

Cuñas rompedoras



WT

L	g	Icon	Model
220	2000		4 W-T-2.0

Cuñas rompedoras



WS

L	g	Icon	Model
230	1500		4 W-S-1.5
250	2000		4 W-S-2.0
260	2500		4 W-S-2.5

Maza con mango en fibra de vidrio



LS-MASSE

L	g	Icon	Model
900	4800		2 LS-MASSE-4FG
900	4450		2 LS-MASSE-4

Maza con mango en fibra de vidrio



LS-MASSE-TR

L	g	Icon	Model
900	4840		2 LS-MASSE-TR-4FG

Mango de repuesto para hachas



SH

L	Icon	Model
800		1 SH-FCS-810
900		1 SH-FCS-860
600		1 SH-FGS-600
700		12 SH-FGS-700
800		1 SH-FGS-800
900		1 SH-FGS-1.8-810
375		1 SH-HFGPS-400FG
400		1 SH-HGPS-400
900		12 SH-MES-F-900
360		12 SH-HGPS-360
380		1 SH-HGPS-380
380		1 SH-HUS-380
500		1 SH-HUS-500
650		1 SH-HUS-650
900		12 SH-MES-900





BAHCO



Cinceles y punteros de chapista



CINCELES DE CHAPISTA

Cortafíos plano



3740

L	Ø	Paquete	Artículo
100	15 mm	5	3740-100
125	15 mm	5	3740-125
150	18 mm	1	3740-150
175	21 mm	5	3740-175
200	24 mm	5	3740-200
250	25 mm	5	3740-250
600	26 mm	5	3740-300

Cortafíos plano con clip para colgar



SB-3740

L	Ø	Paquete	Artículo
125	18 mm	5	SB-3740-125
150	18 mm	5	SB-3740-150
175	21 mm	5	SB-3740-175
200	24 mm	5	SB-3740-200
250	25 mm	5	SB-3740-250
300	26 mm	5	SB-3740-300

Cortafíos plano



3640

L	Ø	Paquete	Artículo
150	18 mm	6	3640-150-C
175	21 mm	6	3640-175-C
200	22 mm	5	3640-200-C
250	28 mm	5	3640-250-C
300	26 mm	6	3640-300-C

Buril



3745

L	Ø	Paquete	Artículo
150	6 mm	5	3745-150
175	7 mm	5	3745-175
200	8 mm	5	3745-200
250	9 mm	5	3745-250

Cortafíos para grietas



3750

L	Ø	Paquete	Artículo
240	26 mm	5	3750

Cinzel de albañil



3736M

L	Ø	Paquete	Artículo
200	8 mm	5	3736M-200
250	20 mm	5	3736M-250
300	26 mm	5	3736M-300
400	26 mm	5	3736M-400

Cinzel



8740

L	Ø	Paquete	Artículo
200	20 mm	5	874002000
250	25 mm	5	874002500
300	26 mm	5	874003000
350	26 mm	5	874003500

L	Ø	Paquete	Artículo
400	26 mm	5	874004000
500	26 mm	5	874005000

Juego de 6 buriles



3736S/6

g	Paquete	Artículo
840	1	3736S/6

3735-4-120, 3735-5-150

3733-3

Cinzel de punta



3739-250 / -400

L	Ø	Paquete	Artículo
250	16 mm	5	3739-250
300	18 mm	5	3739-300
400	18 mm	5	3739-400

CINCELES DE CHAPISTA CON PROTECCION

Cortafíos con cabeza reforzada



3750H

L	Ø	Paquete	Artículo
240	26 mm	1	3750H

Cinzel de albañil con cabeza reforzada



3736MH

L	Ø	Paquetes	Artículos
250	23 mm	2	3736MH-250
300	26 mm	2	3736MH-300
400	26 mm	2	3736MH-400

Cinzel de punta con cabeza reforzada



3739H

L	Ø	Paquetes	Artículos
250	16 mm	2	3739H-250
300	18 mm	2	3739H-300
400	18 mm	2	3739H-400

CINCELES DE CHAPISTA CON MANGO BIMATERIAL

Bandeja modular con 7 cinceles



3654BMS/7

g	Paquetes	Artículos
920	1	3654BMS/7

3734BM-6, 3734BM-2, 3734BM-4, 3734BM-5

3654BM-20, 3654BM-15

3755BM-6

CINCELES DE CHAPISTA (REAFILABLES)

Cortafíos



8741

L	Paquetes	Artículos
400	5	874104000

Puntero Octogonal



8746

L	Ø	Paquetes	Artículos
200	14 mm	5	874602000
250	14 mm	5	874602500
300	16 mm	5	874603000
350	16 mm	5	874603500
400	18 mm	5	874604000

Cinzel de electricista



8760

L	Ø	Paquetes	Artículos
200	10 mm	10	876002000
250	10 mm	5	876002500

Cinzel de chapista



8770

L	Ø	Paquetes	Artículos
240	26 mm	8	877002400

PUNTEROS

Granete con protector para la mano



3643

Ø	L	Paquetes	Artículos
3	100	5	3643-100
4	120	5	3643-120
5	120	5	3643-150

Granete color cobre, mango octogonal



3735

Ø	L	Paquetes	Artículos
4	120	5	3735-4-120
5	120	5	3735-5-120
5	150	5	3735-5-150

Granete con mango hexagonal



3735N

Ø	L	Paquetes	Artículos
2	100	10	3735N-2-100
4	120	10	3735N-4-120
5	120	10	3735N-5-120
6	150	10	3735N-6-150
8	150	10	3735N-8-150
2	100	1	SB-3735N-2-100
4	120	60	SB-3735N-4-120
5	120	1	SB-3735N-5-120
6	150	1	SB-3735N-6-150
8	150	1	SB-3735N-8-150

SB: Clip para colgar



Juego de 4 granetes cromados
2-4-6-8mm



3735NS/4

g			
340	25	3735NS/4	

3735N-2-100, 3735N-4-120, 3735N-6-150,
3735N-8-150

Punzón automático



1157

Ø	L		
2	130	20	1157

Botador con protector para la mano



3644

Ø	L		
2	120	5	3644-120
3	125	5	3644-125
4	130	5	3644-130
4	150	5	3644-150
5	165	5	3644-165
6	180	5	3644-180
8	200	5	3644-200

Botador con manguito guía



3659

Ø	L		
0.9	75	5	3659-0.9
1.4	85	5	3659-1.4
1.8	85	5	3659-1.8
2.4	90	5	3659-2.4
2.8	95	5	3659-2.8
3.4	95	5	3659-3.4
3.9	100	5	3659-3.9
** 5.9	100	5	3659-6.0

Botador cónico color cobre mango octogonal



3733

Ø	L		
2	120	5	3733-2
3	120	5	3733-3
4	120	5	3733-4
5	120	5	3733-5
6	120	5	3733-6

Botador con protector para la mano



3646

Ø	L		
2	115	5	3646-115
3	125	5	3646-125
4	150	5	3646-150
5	165	5	3646-165
6	180	5	3646-180
8	200	5	3646-200

Botador con protector para la mano



3658A

Ø	L		
2	150	5	3658A-2
2	150	5	3658A-3
4	150	5	3658A-4
4	150	5	3658A-5
6	150	5	3658A-6
7	150	5	3658A-8

Botador cilíndrico color cobre mango octogonal



3734

Ø	L		
2	150	5	3734-2
3	150	5	3734-3
4	150	5	3734-4
5	150	5	3734-5
6	150	5	3734-6
8	150	5	3734-8

Botador cilíndrico mango hexagonal



3734N

Ø	L		
2	150	10	3734N-2-150
3	150	10	3734N-3-150
4	150	10	3734N-4-150
5	150	10	3734N-5-150
6	150	10	3734N-6-150
7	150	10	3734N-7-150
8	150	10	3734N-8-150
9	150	10	3734N-9-150
10	150	10	3734N-10-150
2	150	1	SB-3734N-2-150
3	150	1	SB-3734N-3-150
4	150	60	SB-3734N-4-150
5	150	1	SB-3734N-5-150
6	150	60	SB-3734N-6-150
7	150	1	SB-3734N-7-150
8	150	1	SB-3734N-8-150
10	150	1	SB-3734N-10-150

Juego de 6 botadores con protector para la mano



3646/6



730



1 3646/6

3646-115, 3646-125, 3646-150, 3646-165, 3646-180, 3646-200



Juego de herramientas, 6 piezas



3654R



870



1 3654R

Juego de 8 botadores



3659/8



270



1 3659/8

3659-0.9, 3659-1.4, 3659-1.8, 3659-2.4, 3659-2.8, 3659-3.4, 3659-3.9, 3659-6.0



Juego de 6 botadores



3734S/6



720



1 3734S/6

3734-2, 3734-3, 3734-4, 3734-5, 3734-6, 3734-8



Juego de herramientas, 10 piezas



3656/10



1260



1 3656/10

Juego de 6 botadores con protector para la mano



3658A/6



560



1 3658A/6

3658A-2, 3658A-3, 3658A-4, 3658A-5, 3658A-6, 3658A-8



Juego de 8 botadores en estuche de plástico



3659/8T



170



1 3659/8T

3659-0.9, 3659-1.4, 3659-1.8, 3659-2.4, 3659-2.8, 3659-3.4, 3659-3.9, 3659-6.0

Juego de 5 botadores cónicos dorados 2-4-6-8-10mm



3733S/5



410



1 3733S/5

3733-4, 3733-2, 3733-6

3733-8, 3733-10



Juego de 9 botadores cilíndricos 2-10mm 9 piezas 2-10mm



3734NS/9



750



10 3734NS/9

3734N-10-150, 3734N-2-150, 3734N-3-150, 3734N-4-150, 3734N-5-150, 3734N-6-150, 3734N-7-150, 3734N-8-150, 3734N-9-150



Botador con protector para la mano en blister



3732

Ø	L		
2	125	60	SB-3732-2-125
2.5	125	60	SB-3732-2.5-125
3.2	125	60	SB-3732-3.2-125
4	125	1	SB-3732-4-125

Ø		
34	1	B400.034
35	1	B400.035
36	1	B400.036
37	1	B400.037
38	1	B400.038
39	1	B400.039
40	1	B400.040
41	1	B400.041
42	1	B400.042
43	1	B400.043
44	1	B400.044
45	1	B400.045
46	1	B400.046
47	1	B400.047
48	1	B400.048
49	1	B400.049
50	1	B400.050

Tapón sacabocados mango 2 a 50 mm



JLBM50M53PA

L	g	
170	780	1 JLBM50M53PA

Sacabocados



B400

Ø		
2	1	B400.002
3	1	B400.003
4	1	B400.004
5	1	B400.005
6	1	B400.006
7	1	B400.007
8	1	B400.008
9	1	B400.009
10	1	B400.010
11	1	B400.011
12	1	B400.012
13	1	B400.013
14	1	B400.014
15	1	B400.015
16	1	B400.016
17	1	B400.017
18	1	B400.018
19	1	B400.019
20	1	B400.020
21	1	B400.021
22	1	B400.022
23	1	B400.023
24	1	B400.024
25	1	B400.025
26	1	B400.026
27	1	B400.027
28	1	B400.028
29	1	B400.029
30	1	B400.030
31	1	B400.031
32	1	B400.032
33	1	B400.033

Tapón sacabocados mango 2 a 20 mm



JLB.M.20N

L	g	
95	320	1 JLB.M.20N

Juego sacabocados, 11 piezas



400,003,020

Ø		
3-20	1	400.003.020

Tapón sacabocados mango 2 a 30 mm



JLB.M.30N

L	g	
160	530	1 JLB.M.30N

Juego sacabocados, 16 piezas



400,003,030

Ø		
3-30	1	400.003.030

Juego punzones 2 a 50 mm



400,002,050

2-50 mm	1	400.002.050

Sacabocados revólver



2635

245	1	2635

Sacabocados revólver
Medidas: 2.0/2.5/3.0/3.5/4.0/4.5mm



4630

220	1	4630

Perforador de chapa métrico redondo



6900

16	1	690000160
20	1	690000200
22	1	690000220
25	1	690000250
30	1	690000300
32	1	690000320
35	1	690000350
40	1	690000400
50	1	690000500
63	1	690000630

Juego 7 perforadores chapa



6907

4080	1	69079019P

- 690000160, 690000250, 690000200, 690000320, 690000500, 690000400, 690000630
- 690900080, 690900100, 690900120, 690900140, 690900200

Tornillos de repuesto para perforadores de chapa



6909

16	1	690900080
20-25	1	690900100
30-35	1	690900120
40-50	1	690900140
63	1	690900200

PUNTEROS CON MANGO BIMATERIAL

Bandeja modular 7 botadores cilíndricos
2-3-4-5-6-8-10mm



3734BMS/7

900	1	3734BMS/7

- 3734BM-2, 3734BM-3, 3734BM-4, 3734BM-5, 3734BM-6, 3734BM-8, 3734BM-10





BAHCO



Palancas



BARRAS DESECOFRADORAS

Palanca ajustable de 260 mm



APB260

260 mm	410	10	APB260

Palanca ajustable de 360 mm



APB360

360 mm	543	10	APB360

Palanca Crowfoot - Acabado preciso 10"



CFP250

250	6	CFP250

Palanca Crowfoot - Acabado ancho 10"



CFW250

250 mm	6	CFW250

Barra desencofradora premium



WBP

14 mm	346	20	WBP300
16 mm	487	12	WBP500
17 mm	625	12	WBP625
17 mm	704	10	WBP710
20 mm	890	6	WBP900

Barra desencofradora



WBB

391	14 mm	10	WBB400
500	16 mm	10	WBB500
595	18 mm	10	WBB600
680	18 mm	6	WBB700
810	18 mm	6	WBB800

Barra desencofradora plana



WBF380

374	35 mm	12	WBF380

Mini palanca plana



WBMF190

18 mm	188	24	WBMF190



Herramientas para plantación y cultivo



PALAS

Pala en punta



4250

330	1	4250M0020
335	6	4250M0030
340	1	4250A0030

T=mango muleta, YD=mango anilla

Pala boca redonda



LST-80121

1220	5	LST-80121

Pala de nieve, pequeña



LST-72324

780	5	LST-72324

Pala de nieve, grande



LST-73524

1270	5	LST-73524

Pala boca cuadrada



LST-70120

1295	5	LST-70120

REPUESTOS

Mango de madera para palas en T



4250M

690	6	4250MM000

AZADAS

Raedera



4300

160	260	1 430002600

RASTRILLOS

Rastrillo de jardín, 12 púas



LST-30111

1470	5	LST-30111

Rastrillo paisajistas, 16 púas



LST-32011

1545	5	LST-32011

Rastrillo, 29 púas de plástico



LST-42312

1730	5	LST-42312

Rastrillo, 21 púas de plástico



LST-41312

1555	5	LST-41312

Rastrillo para horas, púas metálicas



LST-40311



1700



5 LST-40311

Lanza azuela



P278



455



5 P278

Cultivador



P274



470



5 P274

PEQUEÑAS HERRAMIENTAS DE JARDINERÍA

Azuela



P272



450



5 P272

Azada horquilla



P267



320



10 P267

Cultivador



P264



315



10 P264

Azada



P262



315



10 P262

Lanza Azuela



P268



320



10 P268

Rastrillo



P276



450



5 P276

Azuela horquilla



P277



455



5 P277

Transplantador



P263



370



10 P263

Rastrillo



P266



335



10 P266



Escarvador



P269

315	10	P269

Pala escavadora, grande



LST-621218

1200	5	LST-62121

Gancho para jardín



LST-99102

1030	4	LST-99102

Tridente



P270

305	10	P270

Plancha para corte de césped



LST-63102

1045	5	LST-63102

Horquilla para suelos



LST-52102

1110	5	LST-52102

Plantador de bulbos



P241

340	5	P241

HORCAS

Rastrillo para cavar, mediano



LST-51121

1030	5	LST-51121

Rastrillo para abono



LST-50123

1215	5	LST-50123

PALAS

Pala escavadora, mediana



LST-61121

1080	5	LST-61121

Rastrillo para cavar, grande



LST-52121

1200	5	LST-52121



Herramientas de poda



PODADERAS DE UNA MANO

Podadera ergonómica de mango fijo



PX

15	2	PX-S1
20	2	PX-S2
15	2	PX-M1
20	2	PX-M2
20	2	PX-M2-L
30	2	PX-M3
20	2	PX-L2
30	2	PX-L3

L: Zurdos

Podadera ergonómica de mango rotativo



PXR

15	2	PXR-S1
20	2	PXR-S2
15	2	PXR-M1
20	2	PXR-M2
20	2	PXR-M2-L
30	2	PXR-M3
15	2	PXR-L1
20	2	PXR-L2

L: Zurdos

Recambio de mangos para podaderas PX/PXR
Con muelle



R811P-RT824P

Px-S	1	R811P
Px-M	1	R812P
Px-L	1	R813P
Px-M2-L	1	R815P
PxR-S	1	RT821P
PxR-M	1	RT822P

PxR-L	6	RT823P
PxR-M2-L	1	RT824P

Cabeza de corte pre-ensamblada para PX-PXR



R801P-R804P

1	1	R801P
2	1	R802P
3	1	R803P
2	1	R804P

Recambio de hoja para podadera



R211P/R300P/R500P/R600P

Px/ PxR N° 2, P1-20, P2-20	1	R211P
PX/ PXR N° 2, P1-20, P2-20	80	R211P-BULK80
Px/ PxR N° 1	1	R300P
Px/ PxR N° 3	40	R500P
Px-M2-L & PxR-M2-L	1	R600P

Recambio de contra-hoja para PX/PXR



R303P-R603P

Px-S1, Px-M1, Px-L1, PxR-M1, PxR-L1	1	R303P
Px-S2, Px-M2, Px-L2, PxR-M2, PxR-L2	1	R403P
Px-S3, Px-M3, Px-L3, PxR-M3, PxR-L3	1	R503P
Px-M2-L, PxR-M2-L	1	R603P

Recambio del perno central para podadera ERGO™



R900P

PX & PXR	20	1 R900P

Recambio del bloqueo del perno central



R901P

PX & PXR	10	30 R901P

Juego de recambio de 4 tornillos para PX/PXR



R902P

PX & PXR	20	24 R902P

Recambio de 2 topes de goma para podaderas PX/
PXR
50 topes a granel



R903P/R1269P

PX & PXR, P1 & P2, P64	10	1 R903P
PX & PXR, P1 & P2, P64	486	50 R1269P-BULK50

Recambio del cierre para podaderas PX/PXR



R904P

Px & PxR	10	1	R904P

Recambio muelles
R906P Resistencia Media



R905P-R907P

PX & PXR, P64	10	1	R905P
PX & PXR, P64	164	50	R905P-BULK50
PX & PXR	10	1	R906P
PX & PXR	220	50	R906P-BULK50
PX & PXR	10	1	R907P

Dureza: R905P (blanda)
R906P (media)
R907P (dura)

Podadera de mango fijo Ergo®



PG-S/M/L

15	2	PG-S1-F
20	2	PG-M2-F
20	2	PG-L2-F

Podadera de mango rotativo Ergo®



PG-R-M

20	2	PG-R-M2-F

Podadera para trabajos de mantenimiento jardín



PG-01-F/PG-03-L

12-20	6	PG-01-F
12-20	2	PG-03-L

PG-01-F: Diestros PG-03-L: Zurdos

Podadera de una mano



P121

15	6	P121-18-F
20	6	P121-20-F
25	6	P121-23-F

Podadera de una mano



P126

15	6	P126-19-F
20	6	P126-22-F

Podadera de una mano



PG-12-F

20	10	PG-12-F
20 mm	15	PG-12-BULK15

Podadera de una mano, forjada



P3

20	2	P3-20-F
25	2	P3-23-F

Podadera de una mano



P110

20	2	P110-20-F
25	2	P110-23-F



Podadera una mano con mango de composite



P1

20	5	P1-20
30	5	P1-23

Repuestos disponibles

Podadera de una mano



P108

20	2	P108-20-F
25	2	P108-23-F

Podadera de una mano, forjada



P5

20	2	P5-20-F
25	2	P5-23-F

Podadera de una mano



P138

20	6	P138-22-F

Cizallas



P39

25 mm	2	P39-22

Podadera de una mano



P64

12	6	P64-20
12	12	P64-20-BULK12

Recambio del yunque de aluminio con remache



R221P

P138-22	1	R221P
P138-22	50	R221P-BULK50

Recambio de hoja para P1 y P2



R201P/R171P

P1-22, P2-22	1	R201P
P1-22, P2-22	80	R201P-BULK80
P6-20, P7-20	1	R171P

Recambios de hoja con pasador para podaderas una mano y de pértiga



R112PG-R124PG/R223P

P3-20, P5-20	1	R112PG
P108-20, P110-20	1	R114PG
P3-23, P5-23	30	R122PG
P108-23, P110-23, P34-27A	30	R124PG
P138-22	1	R223P
P138-22	80	R223P-BULK80

Recambio de contra-hoja para podaderas una mano



R202P/R271P



P1-22, P2-22

1 R202P

Perno completo para podaderas de una mano



R239P/R141P/R142P



P1-20, P1-22, P2-20, P2-22,
P6-20, P7-20

1 R239P

P34-27A, P3-20, P3-23, P5-20,
P5-23, P108-20, P108-23,
P110-20, P110-23

24 R142P

Recambios de contra-hoja y pasador
Podaderas de una mano y pértiga



R113PG/R123PG



P108-20, P110-20
P108-23, P110-23

30 R113PG
30 R123PG

Recambio de cierre



R341P/R474P



P3-20, P3-23

12 R341P

P5-20, P5-23, P108-20,
P108-23, P110-20,
P110-23

1 R474P

Recambio de muelles para podaderas de una mano



R438P/R463P



P121-23

1 R463P

P138-22

1 R438P

P138-22

50 R438P-BULK50

Recambio de muelle y tope para podaderas de una
mano



R1069P

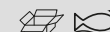

P1-20, P2-20, P6-20, P7-20

12 R1069P

Recambio de muelle, tope de goma y tope metálico



R1068



P3-20, P3-23, P5-20, P5-
23, P108-20, P108-23,
P110-20, P110-23

1 R1068

Recambios para P5-20 y P-23



R1080P



P5-20, P5-23

1 R1080P

Recambio de tornillos, tuerca y cierre para los mangos



R1601



P1-20, P1-22, P2-20,
P6-20, P7-20

1 R1601



Sistema de cierre con tornillo y tuerca



R478P/R480P

P108	1	R478P
P5	1	R480P

Tijera de vendimia y recolección



P128

6	6	P128-19		
6	30	P128-19-BULK30		

PODADERAS DE DOS MANOS

Podadora super ligera



P114-SL

30	400	2	P114-SL-40
30	500	2	P114-SL-50
30	600	2	P114-SL-60

HERRAMIENTAS PARA RECOGIDA DE FRUTA

Tijera de vendimia y recolección



P123

10	15	P123-19-BULK15
10	30	P123-19-BULK30
10	56	P123-19-BULK56

Tijera de vendimia y recolección



P129

6	30	P129-19-BULK30		

Podadera de dos manos



P16

30	400	2	P16-40
30	500	2	P16-50-F
30	600	2	P16-60-F

Tijera de vendimia y recolección



P127

6	30	P127-19-BULK30

Recambios de muelles y topes
P123/P127/P128/P129



R1071/R1075

P123, P127, P128, P129	20	14	R1071
P123, P127, P128, P129	130	50	R1075-BULK50

Podadera de dos manos



P16-40W

30 mm	400 mm	2	P16-40W

Podadera super ligera



P116-SL

Icon	L	Icon	Icon
	400	2	P116-SL-40
	500	2	P116-SL-50
	600	2	P116-SL-60
	700	2	P116-SL-70



Podadera con cuchilla de acción bypass



P280-SL

Icon	L	Icon	Icon
	800	2	P280-SL-80



Podadera corta para expertos



PG-18-45

Icon	L	Icon	Icon
	450	2	PG-18-45-F



Podadera super ligera



P160-SL

Icon	L	Icon	Icon
	600	2	P160-SL-60
	750	1	P160-SL-75
	900	1	P160-SL-90



Podadera con sistema multiplicador



P173-SL

Icon	L	Icon	Icon
	850 mm	1	P173-SL-85



Podadera de dos manos telescópica para expertos



PG-19

Icon	L	Icon	Icon
	700 - 900	2	PG-19-F



Podadera de dos manos



P19

Icon	L	Icon	Icon
	800	1	P19-80-F



Podadera ligera de dos manos



PG-18

Icon	L	Icon	Icon
	610	2	PG-18-60-F



Podadera de dos manos



P130-P140

Icon	L	Icon	Icon
	450	6	P130-F
	600	6	P140-F





Recambios disponibles



Recambio de contra-hoja para podaderas de dos manos





R214V/R26V/R260A/...

		
P14	1	R214V
P14	28	R214V-BULK28
P116-SL	8	R216SL
P-SL-40/45/60	1	R215V
P114-SL	1	R214SL
P160	16	R260A
P16*	40	R716VCB
P180-70	1	R680V
P19-80	1	R619V

Recambio de topes de goma para podaderas de dos manos y cortasetos



R430V-R516V

		
P-SL, P-SL2, P114, P116 - all 40 cm	1	R430V
P-SL, P-SL2, P114, P116, P52-SL, P54-SL	22	R440V

Recambio de yunque con tornillos para podaderas de dos manos





R372H

		
P172-65 /-85, P172-SL	1	R372H

Perno central/tuerca para podaderas de dos manos





R312V-R318V/R143PV/R144PV/R146

		
P16	1	R143PV
P16*	1	R143PVCB
P160	24	R144PV
P14, P174, P176-75	24	R146VS
P14, P174, P176-75	50	R146VS-BULK50
P114-SL, P116-SL	22	R166V
P172-65 /-85	1	R312V
P-SL-40 /-45 /-60	1	R315V
P280-(SL)	22	R328V
P180-70, P19-80, P172	1	R318V

Juego completo recambios mango, tornillo y tuerca para podaderas de dos manos



R415V-R773V

		
P-SL, P-SL2, P114, P116	1	R415V
P180-70	1	R419V
P19-80	1	R519V
P14, P16	1	R615V
P160	24	R660V
P172-SL	14	R772V
P280-SL-80	1	R773V

Tornillo hexagonal para ajustar a la hoja al yunque





R272H

		
P172-65/-85, P172-SL-85	1	R272H

Recambio de hoja para podaderas de dos manos



R114V/R373A

		
P14	25	R114V
P14	28	R114V-BULK28
P214	10	R414V-BULK10
P280	1	R181P
P-SL2, P116-SL	1	R16V
P-SL2, P116-SL	14	R16V-BULK14
P-SL, P114-SL	8	R115V
P-SL, P114-SL	14	R115V-BULK14
P172-85, P172-65	1	R172A
P16-40W	25	R116VP
P16	1	R116V
P16	36	R116V-BULK36
P19-80	1	R119V
P160	1	R160A
P180-70	20	R180V
P173-SL-85	25	R373A

SERRUCHOS CON PÉRTIGA Y PODADERAS DE ALTURA

Podadera de pértiga, triple efecto multiplicador



P34-37

		
40	2	P34-37

Podadera de pértiga, Doble efecto multiplicador



P34-27A

30	2	P34-27A-F

Podadera con pértiga



ap-234

30	2200	2	AP-234-F

Podadera de altura con pértiga telescópica



ATP-230-410

32 mm	2370 - 4110 mm	2	ATP-230-410

Juego de podaderas de altura



ASP3740-P

40 mm	1	ASP3740-P3437

ASP-1850G				
ASP-1850				
P34-37				
ASP-ATP				
4750-PSTB-1				

Pértigas telescópicas



AP-/FP-

2000 - 5000	1	AP-5M
2000 - 3500	1	AP-3M
1800 - 3200	1	FP-3M

Pértiga telescópica corta de aluminio



ATP-110-210

1100 - 2100 mm	1	ATP-110-210

Pértiga de aluminio



ASP-1850G

1870 mm	1	ASP-1850G

Pértiga de aluminio



ASP-1850

1870 mm	1	ASP-1850

Gancho para pértiga con adaptador válido para pértigas ASP y pértiga ATP-110-210



ASP-AS-HOOK

325	4	ASP-AS-HOOK

Serrucho de poda



339-/340-

360	250	4	339-6T
360	250	4	340-6T

Serrucho de poda
Para pértiga telescópica de Ø 25 mm



383-/384-

360	320	4	383-6T
360	320	4	384-6T
360	320	4	384-5T



Serrucho de poda, para pértiga telescópica de Ø 25 mm



385-/386-

360		410	4	385-6T
360		410	4	386-6T

Serrucho curvo con dentado japonés, para pértigas ASP. Corte fino



ASP-AS-C

330		7	5	ASP-AS-C33-JT-F

Serrucho curvo con dentado japonés, para pértigas ASP. Corte medio



ASP-AS-C

360		6,2	5	ASP-AS-C36-JT-M

Serrucho curvo con dentado japonés, para pértigas ASP. Corte grueso



ASP-AS-C

390		5,4	5	ASP-AS-C39-JT-C
450		5,4	2	ASP-AS-C45-JT-C

Set de pértigas con serrucho de 360 mm



ASP3740-C36JTM

1950 mm	2819	1	ASP3740-C36JTM

ASP-1850G			
ASP-1850			
ASP-AS-C36-JT-M			
4750-PSTB-1			

Set de pértigas con serrucho de 450 mm



ASP3740-C45JTC

1950 mm	2863	1	ASP3740-C45JTC

ASP-1850G			
ASP-1850			
ASP-AS-C45-JT-C			
4750-PSTB-1			

Set de pértigas con serrucho de 390 mm



ASP3740-C39JTC

1950 mm	2838	1	ASP3740-C39JTC

ASP-1850G			
ASP-1850			
ASP-AS-C39-JT-C			
4750-PSTB-1			

Adaptador para pértigas



ASP-AS

135 mm		4	ASP-AS

Adaptador para podaderas de altura P34-37 y P34-27A-F



ASP-ATP

160 mm	100	4	ASP-ATP

Recambio para pértigas R2000AP: tornillo + 2 adaptadores



LOCKING

101		8	R2000AP

Recambio de perno central y tuerca



R142P/R337E

P34-37	1	R337E

Hoja curva de repuesto serrucho para pértiga, corte grueso



AS-C-C-BLADE

390	5,4	15	AS-C39-JT-C
450	5,4	15	AS-C45-JT-C

Corta setos



P51-SL

570	25	2	P51-SL

Recambio de contra-hoja para podaderas de una mano y de pértiga
Para podaderas manuales y de altura



R133PG

P34-27A	1	R133PG

Bolsa para transporte de pértiga



4750-PSTB-1

1910 mm	1040 g	1	4750-PSTB-1

Corta setos con mango de madera



P57-25

540	23	4	P57-25-F
540	23	4	P57-25-W-F

Recambio de muelle para podadera de pértiga



R427AE/R427E/R437E

P134, P34-27A	18	R427AE
P34-37	18	R437E

CORTASETOS

Cortasetos profesional, mangos largos



P51

570	25	2	P51-F

Corta setos, largo



P51H-SL

730	1076	2	P51H-SL



Cortasetos ligero para expertos



PG-56

540	23	2	PG-56-F

Corta setos



P59/P60

580	21	6	P59-25-F

Recambios disponibles

Cortacésped



P74

1100	2000	1	P74

Cortasetos ligero, corto



P54-SL

500	18	2	P54-SL-20
550	22.5	2	P54-SL-25

Recambios de topos de goma para corta setos



R440V-R516V

P14, P16, P180-70, P19-80, P160-60, P51	22	R515VS
P160, P160-SL, P280-SL	22	R516V
P53-SL, P54H-SL	22	R444V

Cortacésped



P75

1000	1900	1	P75

Corta setos ligero, largo



P54H-SL

600	18	2	P54H-SL-20
650	22.5	2	P54H-SL-25

Perno central/tuerca para corta setos



R146VC/R147V

P51, P51H, P52, P53, P54	22	R146VC
P55, P57	24	R147V

NAVAJAS DE PODA

Navaja para inyectar



P11

180	70	6	P11

CORTACÉSPEDES

Cortasetos telescópico para expertos



PG-57-F

800-1050 mm	20	2	PG-57-F

Cortacésped regulable en tres posiciones



GS-76

355	435	6	GS-76

Navaja para inyectar



P20

190	100	6	P20

Navaja multi-uso



K-AP-1

175	10	K-AP-1

Navaja multi-uso



K-GP-1

170	10	K-GP-1

TIJERAS

Tijera tamaño pequeño



FS-5

125	10	FS-5

Tijera tamaño medio



FS-8

165	10	FS-8

Tijera tamaño grande



FS-7.5

200	10	FS-7.5

ARCOS TRONZADORES

Arco tronizador para madera verde y seca
23: Madera verde//51: Madera seca



10

530	5	10-21-51
607	5	10-24-23
607	5	10-24-51
759	5	10-30-23
759	5	10-30-51

Arco tronizador



332

530	5	332-21-51

Arco tronizador con hoja posicionable



2-21-51

530	5	2-21-51

Arco tronizador con hoja posicionable



3-24-51

607	5	3-24-51

Arco tronizador



331-21

530	5	331-21-51-KP



Arco tronizador manejable de 15" madera verde



331-15



378

5 331-15-23

Arco tronizador para tubos de ventilación



14-24



607

5 14-24-3810

Hoja de arco tronizador - madera verde

23



378

10 23-15

530

10 23-21

607

10 23-24

759

10 23-30

810

10 23-32

912

10 23-36



Arco tronizador profesional
Tipos de hoja 23 o 51



SE -15/-16



530

5 SE-16-21

530

5 SE-16-21-23

607

5 SE-15-24

759

5 SE-15-30

759

5 SE-15-30-23

810

5 SE-15-32

912

5 SE-15-36

912

5 SE-15-36-23

Arco de sierra multiuso - madera y metal



9-Dec



320

5 9-12-51/3806-KP

Hoja para arco tronizador: madera verde para arco 333



333-5



350

10 333-5

Arco tronizador con hoja posicionable



333



350

5 333

Hoja de arco tronizador - madera seca



51



320

10 51-12

530

10 51-21

607

10 51-24

759

10 51-30

810

10 51-32

912

10 51-36

SERRUCHOS DE PODA

Serrucho de poda



349



300

7

4 349

Serrucho de poda plegable



PG-72



190

4 PG-72

Serrucho plegable, dentado XT, recubrimiento especial



396-LAP

190	200	10	396-LAP
190	44	100	396-BLADE

Serrucho de poda con mango de madera



4211-4212-

280	4	4211-11-6T
360	4	4211-14-6T
280	4	4212-11-6T
360	4	4212-14-6T

Juego de serrucho plegable 396-LAP y cuchillo - machete 2444-LAP



LAP-KNIFE

329	10	LAP-KNIFE

Serrucho de poda plegable, dentado JS



396-JS

190	4	396-JS

Serrucho de poda con funda, sin velcro



51 -JS

240	4	5124-JS-H
280	4	5128-JS-H

REPUESTOS Y ACCESORIOS

Hojas de recambio para serrucho de poda 51-JS



5724-JS/5728-JS

240	1	5724-JS
280	1	5728-JS

Serrucho de poda plegable, dentado JT



396-JT

190	4	396-JT

Hojas de recambio para serrucho de poda 41-JT



4724-JT/4728-JT

240	1	4724-JT
280	1	4728-JT

Serrucho de poda plegable, dentado XT



396-HP

190	4	396-HP

Serrucho de poda, dentado JT



41 -JT

240	4	4124-JT-H
280	4	4128-JT-H

Hojas de recambio para serrucho 396-JS



396-JS-BLADE

190	1	396-JS-BLADE



Hojas de recambio para serrucho 396-JT



396-JT-BLADE

190    1 396-JT-BLADE

Hoja de recambio para serrucho 396-HP





396-HP-BLADE

190    1 396-HP-BLADE

Hojas de recambio, serrucho/poda 4211, 4212, 339 y 340 y podaderas/pértiga P34-37



4400-/4420-

		
280	10	4400-11
360	10	4400-14
280	10	4420-11
360	10	4420-14
280	10	4400-11-BULK
360	10	4400-14-BULK
280	10	4420-11-BULK
360	10	4420-14-BULK

Hoja curva de repuesto serrucho para pértiga, corte fino



AS-F-BLADE

330    7   15 AS-C33-JT-F

Hoja curva de repuesto serrucho para pértiga, corte medio



AS-M-BLADE

360    6,2   15 AS-C36-JT-M

Piedra sintética para afilado, 2 granos 180/400



LS-COMBINESS

100    1 LS-COMBINESS

Piedra natural para afilado



LS-NATURAL

70    1 LS-NATURAL

Piedra sintética para afilado, grano 220



LS-TRIANGLE

100    1 LS-TRIANGLE

Piedra sintética para afilado, grano 320



LS-CORINDON

100    1 LS-PIERRE CORINDON

ACCESORIOS Y MANTENIMIENTO

Afilador profesional de carburo



SHARP-X

100    10 SHARP-X
100 1 SHARP-X-DISP

Piedra sintética para afilado, grano 180



LS-PIERRE-FAUX



230



1 LS-PIERRE-FAUX

Funda de cuero



PROF-H



86



2 PROF-H

Piedra sintética, tipo "Carbor", para afilado, grano 220
Tipo "Carbor", grano 220



LS-6160-23



230



1 LS-6160-23

Funda para podadera



PROF-LOPP



390



1 PROF-LOPP

Lubricante 50 ml



LUB-2015



60



6 LUB-2015

Funda para podadera



PROF-SEC



150



1 PROF-SEC



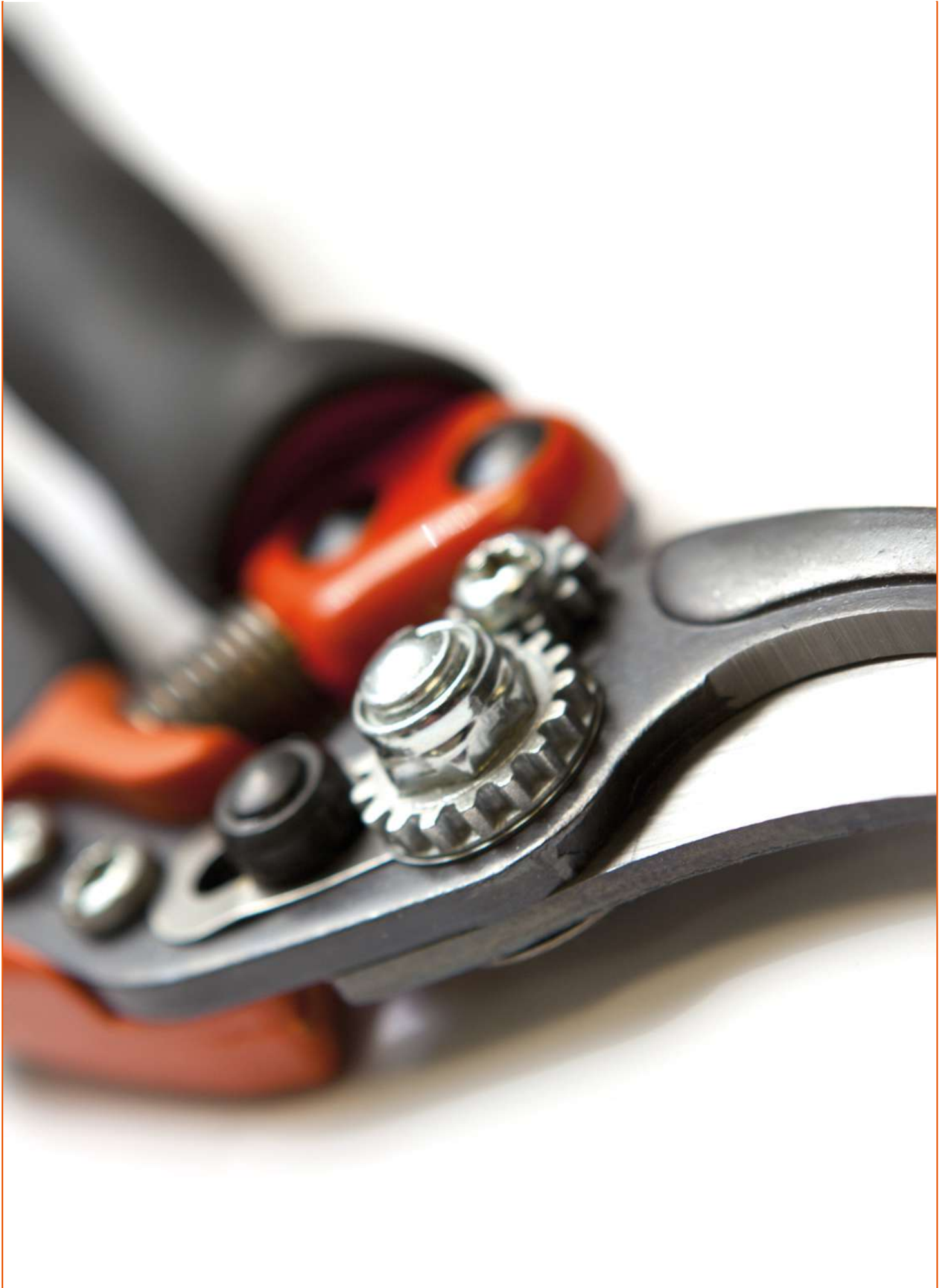

BAHCO



Herramientas neumáticas de exterior



PODADERAS DE UNA MANO

Podadera neumática



9210



30



1 9210

Hoja para podadera neumática



9210-1



9210

g

82



1 9210-1

Cabeza cortante para podadera neumática



9210-10



9210

g

212



1 9210-10

Anillos para las juntas



9210-20



9210

g

28



1

9210-20

Casquillos de latón



9210-1720100



9210

g

55.3



1

9210-1720100

Amortiguadores



9210-1730107



9210

g

176



10

9210-1730107

Muelles de retorno



9210-1640142



9210

g

26.6



1

9210-1640142

Sello para pistón



9210-1230235



9210

g

6.7



1

9210-1230235

Varilla de acoplamiento



9210-1700118



9210

g

41



1

9210-1700118

Pistón



9210-1690148



9210

g

22



1

9210-1690148

Remache



9210-1770106



9210

g

1000



10

9210-1770106

Junta de protección del polvo



9210-1230219

9210	8.6	20	9210-1230219

Cuerpo de podadera



9210-1710266

9210	193	1	9210-1710266

Tornillos autorroscantes o de chapa



9210-1060238

9210	10	20	9210-1060238

Tornillo TCCE



9210-1060177

9210	7	1	9210-1060177

Cubierta frontal



9210-1830137

9210	9.5	1	9210-1830137

Protector de mano



9210-1320281

9210	35	10	9210-1320281





BAHCO



Herramientas de precisión Lindström



ALICATES PARA ELECTRÓNICA Y MECÁNICA DE PRECISIÓN

Alicate de corte diagonal
Cabeza cónica y en relieve



7190, 7191

Diagram	Tip	Material	Quantity	Model
	Micro		10	7190
	Micro		10	7190 CO
	Flush		10	7191
	Flush		10	7191 CO

Alicate de corte diagonal
Cabeza cónica



8143-8165

Diagram	Tip	Material	Quantity	Model
	Micro		10	8143
	Flush		10	8144
	Flush		10	8144 CO
	Ultra		10	8145
	Micro		10	8153
	Flush		10	8154
	Flush		10	8154 CO
	Ultra		10	8155
	Micro		10	8163
	Micro		10	8163 CO
	Flush		10	8164
	Ultra		10	8165
	Ultra		10	8165 CO

Alicate de corte lateral - fosfatado
Cable y plástico

ergo®



P6160

Diagram	Material	Quantity	Model
		10	P6160

Alicate de corte diagonal
Cabeza ovalada



8130-8162

Diagram	Tip	Material	Quantity	Model
	Micro		10	8130
	Flush		10	8131
	Flush		10	8131 CO
	Ultra		10	8132
	Micro		10	8140
	Micro		10	8140 CO
	Flush		10	8141
	Flush		10	8141 CO
	Ultra		10	8142
	Ultra		10	8142 CO
	Micro		10	8150
	Micro		10	8150 CO
	Micro		10	8150 J
	Flush		10	8151
	Flush		10	8151 CO
	Ultra		10	8152
	Micro		10	8160
	Micro		10	8160 CO
	Micro		10	8160 J
	Flush		10	8161
	Flush		10	8161 CO
	Ultra		10	8162

Alicate de corte diagonal
Boca cónica y en relieve



8146-8158

Diagram	Tip	Material	Quantity	Model
	Micro		10	8146
	Flush		10	8147
	Ultra		10	8148
	Ultra		10	8148 CO
	Micro		10	8156
	Flush		10	8157
	Ultra		10	8158

Alicate de corte diagonal
Cabeza cónica

ergo®



RX 8143-RX 8145

Diagram	Tip	Material	Quantity	Model
	Micro		10	RX 8143
	Flush		10	RX 8144
	Ultra		10	RX 8145

Alicate de corte diagonal
Cabeza cónica y relieve

ergo®



RX 8146-RX 8148

Diagram	Tip	Material	Quantity	Model
	Micro		10	RX 8146
	Flush		10	RX 8147
	Ultra		10	RX 8148

Alicate de corte diagonal, serie RX
Corta puntas

ergo®



RX 8149

0.1-0.6	Flush	10	RX 8149

Alicate de corte diagonal
Cabeza ovalada

ergo®



RX 8130-RX 8162

0.2-1.0	Micro	10	RX 8130
0.1-1.0	Flush	10	RX 8131
0.1-0.8	Ultra	10	RX 8132
0.2-1.25	Micro	10	RX 8140
0.1-1.25	Flush	10	RX 8141
0.1-1.0	Ultra	10	RX 8142
0.3-1.6	Micro	10	RX 8150
0.2-1.6	Flush	10	RX 8151
0.2-1.25	Ultra	10	RX 8152
0.4-2.0	Micro	10	RX 8160
0.3-2.0	Flush	10	RX 8161
0.3-1.6	Ultra	10	RX 8162

Alicate de corte oblicuo
Angulo invertido



7280

0.2-08	Flush	10	7280

Alicate de corte oblicuo 45°
Angulo invertido



7285

0.2-1.0	Flush	10	7285

Alicate de corte oblicuo 20°
Cabeza corta



8211

0.2-1.2	Flush	10	8211

Alicate de corte oblicuo 45°
Cabeza larga



8247

0.2-1.0	Flush	10	8247
0.2-1.0	Flush	10	8247 CO

Alicate de corte oblicuo 45°
Cabeza larga y en relieve



8248

0.2-0.8	Flush	10	8248
0.2-0.8	Flush	10	8248 CO

Alicate de corte oblicuo 20°
Cabeza corta

ergo®



RX 8211

0.2-1.2	Flush	10	RX 8211

Alicate de corte oblicuo 45°
Cabeza larga

ergo®



RX 8247

0.2-1.0	Flush	10	RX 8247

Alicate de corte oblicuo 45°
Cabeza larga, en relieve

ergo®



RX 8248

0.2-0.8	Flush	10	RX 8248



Alicates de corte oblicuo
Serie Supreme



7290.7291

0.35-1.25	Micro	10	7290
0.35-1.25	Flush	10	7291



Alicates de corte micro



RX 8237

0.1-0.65	Flush	10	RX8237



Alicates de boca redonda
Serie Supreme



7590

20	1	7590
20	10	7590 CO



Alicates de corte oblicuo
Serie Supreme



7293

0.35-1.0	Flush	10	7293



Alicates de boca plana
Serie Supreme



7490

20	10	7490
20	10	7490 CO



Alicates de boca redonda, Serie RX



RX 7590

20	10	RX 7590



Alicates de corte micro



RX 8233

0.1-0.65	Flush	10	RX8233



Alicates de boca plana, Serie RX



RX 7490

20	10	RX 7490



Alicates de boca semiredonda
7890 con mordazas lisas y 7892 con mordazas dentadas



7890, 7891

32.5	10	7890
32.5	10	7890 CO
32.5	10	7891
32.5	10	7891 CO



Alicate de boca redonda y puntas curvadas Serie Supreme



7892



20 10 7892

Alicate de boca semicircular con puntas curvadas Serie RX

ergo®



RX 7892



29 10 RX 7892

Alicate de corte frontal Supreme series



7292



0.35 - 0.8 Flush 10 7292

Alicate de boca redonda corta Serie Supreme



7893



20 10 7893

Alicate de boca semi-redonda Serie RX

ergo®



RX 7893



20 10 RX 7893

Alicates para el corte de Kevlar



HS6000



2.0 10 HS6000

Alicate de boca semicircular RX7890 con mordazas lisas y Rx 7891 con mordazas dentadas

ergo®



RX 7890, RX 7891



32 10 RX 7890
32 10 RX 7891

Alicate de corte lateral - fosfatado Dos en Uno: Alambre de piano y Cable



TRX 8180



4.5 2.5 5 TRX 8180

Recoge virutas



813/814

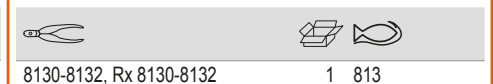

8130-8132, Rx 8130-8132 1 813



Muelle de retorno para la serie RX



RX 01



5

1 RX 01

PINZAS PARA ELECTRÓNICA Y MECÁNICA DE PRECISIÓN

Pinzas tipo Boley, protección ESD



TL 00-SA-ET



120

1 TL 00-SA-ET

Pinza tipo Boley, protección ESD



TL 3-SA-ET



120

1 TL 3-SA-ET

Pinzas de alta precisión
Puntas planas y fuertes, zona de agarre estriada



TL 00B-SA



120

1 TL 00B-SA

Pinza de alta precisión, puntas fuerte con mango estriado. Puntas planas y fuertes, zona de agarre y punta estriadas



TL 00D-SA



120

1 TL 00D-SA

Acero inox, anti-magnético, anti-ácido

Pinzas de alta precisión
Puntas planas y reforzadas



TL 00-SA



120

1 TL 00-SA

Acero inox, anti-magnético, anti-ácido

Pinzas de alta precisión
Puntas planas y reforzadas



TL 0C9-SA



90

1 TL 0C9-SA

Acero inox, anti-magnético, anti-ácido

Pinzas de alta precisión
Puntas finas y planas



TL 0-SA



120

1 TL 0-SA

Acero inox, anti-magnético, anti-ácido

Pinzas de alta precisión con mangos estriados
Puntas finas y estriadas



TL 10G-SA



110

1 TL 10G-SA

Acero inox, anti-magnético, anti-ácido

Pinzas de alta precisión
Para corte 0.1 a 0.25 de alambre blando



TL 15AP



115

1 TL 15AP

Alambre de acero al carbono

Pinzas con puntas reforzadas de alta precisión
Puntas fuertes y de precisión



TL 1-SA



120

1 TL 1-SA

Acero inox, anti-magnético, anti-ácido

Pinzas de alta precisión
Puntas curvadas planas y redondeadas



TL 2AB-SA



120

1 TL 2AB-SA

Acero inox, anti-magnético, anti-ácido

Pinzas de alta precisión
Puntas redondeadas reforzadas



TL 2A-SA



120



1 TL 2A-SA

Acero inox, anti-magnético, anti-ácido

Pinzas de alta precisión
Puntas muy afiladas



TL 3-SA



120



1 TL 3-SA

Acero inox, anti-magnético, anti-ácido

Pinzas de alta precisión
Puntas extrafinas curvadas



TL 5B-SA



110



1 TL 5B-SA

Acero inox, anti-magnético, anti-ácido

Pinzas de alta precisión
Puntas reforzadas y afiladas



TL 2-SA



120



1 TL 2-SA

Acero inox, anti-magnético, anti-ácido

Pinzas de alta precisión
Puntas afiladas extra-finas



TL 4-SA



110



1 TL 4-SA

Acero inox, anti-magnético, anti-ácido

Pinzas de alta precisión
Puntas cónicas extra finas



TL 5-SA



110



1 TL 5-SA

Pinzas de alta precisión
Puntas muy puntiagudas



TL 3C-SA



110



1 TL 3C-SA

Acero inox, anti-magnético, anti-ácido

Pinzas de alta precisión
Puntas extrafinas, doble curvatura



TL 51S-SA



115



1 TL 51S-SA

Acero inox, anti-magnético, anti-ácido

Pinzas de alta precisión



TL 5-TA



110



1 TL 5-TA

Pinzas de alta precisión de titanio
Puntas muy afiladas



TL 3C-TA



110



1 TL 3C-TA

Anti-magnético, anti-ácido
Super ligeras

Pinzas de alta precisión
Puntas extrafinas, ligeramente curvadas



TL 5A-SA



115



1 TL 5A-SA

Acero inox, anti-magnético, anti-ácido

Pinzas de alta precisión
Largas, punta curvada



TL 65A-SA



140



1 TL 65A-SA

Acero inox, anti-magnético, anti-ácido



Pinzas de alta precisión, reforzadas, puntas curvadas
Puntas fuertes, finas y curvadas



TL 7A-SA



115



1 TL 7A-SA

Acero inox, anti-magnético, anti-ácido

Pinzas para uso industrial
Acero inox, anti-magnético, anti-ácido



TL 00-SA-SL



120



5 TL 00-SA-SL

Pinzas para uso industrial
Acero inox, anti-magnético, anti-ácido



TL 3C-SA-SL



110



5 TL 3C-SA-SL

Pinzas de alta precisión
Finas, con puntas curvadas



TL 7-SA



115



1 TL 7-SA

Acero inox, anti-magnético, anti-ácido

Pinzas de uso industrial
Acero inox, anti-magnético, anti-ácido



TL 1-SA-SL



120



5 TL 1-SA-SL

Pinzas de uso industrial
Acero inox, anti-magnético, anti-ácido



TL 3-SA-SL



120



5 TL 3-SA-SL

Puntas muy afiladas

Pinzas de alta precisión
Largas, puntas muy finas



TL SS-SA



140



1 TL SS-SA

Acero inox, anti-magnético, anti-ácido

Pinzas para uso industrial
Acero inox, anti-magnético, anti-ácido



TL 2A-SA-SL



120



5 TL 2A-SA-SL

Pinzas con puntas muy afiladas uso industrial
Acero inox, anti-magnético, anti-ácido



TL 4-SA-SL



110



5 TL 4-SA-SL

Pinzas Multi-uso
De acción invertida, tipo 2A



TL 2AX-SA



120



1 TL 2AX-SA

Acero inox, anti-magnético, anti-ácido

Pinzas para uso industrial
Acero inox, anti-magnético, anti-ácido



TL 2-SA-SL



120



5 TL 2-SA-SL

Pinzas con puntas finas, ligeramente curvadas
Acero inoxidable, anti-magnético, anti-ácido



TL 5A-SA-SL



115



5 TL 5A-SA-SL

Acero inox, anti-magnético, anti-ácido

Pinzas con puntas extra finas para uso industrial
Acero inoxidable, anti-magnético, anti-ácido



TL 5-SA-SL



110 5 TL 5-SA-SL

Acero inox, anti-magnético, anti-ácido

Pinzas para uso industrial
Acero inox, anti-magnético, anti-ácido



TL SS-SA-SL



140 5 TL SS-SA-SL

Pinzas con puntas finas y reforzadas
Acero inoxidable, anti-magnético, anti-ácido



TL AA-SA-SL



130 5 TL AA-SA-SL

Acero inox, anti-magnético, anti-ácido

Pinzas multi-uso inox
Mangos estriados y puntas redondeadas con dentado



TL 475-SA



140 1 TL 475-SA

Anti-magnético, anti-ácido

Pinzas con puntas finas, curvadas
Acero inoxidable, anti-magnético, anti-ácido



TL 7A-SA-SL



115 5 TL 7A-SA-SL

Acero inox, anti-magnético, anti-ácido

Pinzas con puntas fuertes precisas, mangos y dientes dentados. Puntas fuertes y finas con pin de alineación, zona de agarre y punta estriadas



TL 648-SA



150 1 TL 648-SA

Con un pin para mejor alineamiento
Acero inox, antimagnético, anti-ácido

Pinzas con puntas extra finas y curvadas uso industrial
Acero inox, anti-magnético, anti-ácido



TL 7-SA-SL



115 5 TL 7-SA-SL

Acero inox, anti-magnético, anti-ácido

Pinzas con puntas reforzadas para uso industrial
Acero inoxidable, anti-magnético, anti-ácido



TL MM-SA-SL



130 5 TL MM-SA-SL

Acero inox, anti-magnético, anti-ácido

Pinzas con punta fuerte precisa, curvadas
Puntas fuertes y finas con pin de alineación, zona de agarre y punta estriadas



TL 649-SA



150 1 TL 649-SA

Acero inox, anti-magnética, anti-ácido

Pinzas para uso industrial
Acero inoxidable, anti-magnético, anti-ácido



TL AC-SA-SL



AC-SA 110 mm 5 TLAC-SA-SL

Acero inox, anti magnético, anti ácido

Pinzas puntas fuertes doble inclinación, estriadas
Puntas fuertes y dobles, zona de agarre y punta estriadas



TL 124-SA



150 1 TL 124-SA

Acero inox, anti magnético, anti ácido

Pinzas de precisión punta fuerte
Puntas fuertes y de precisión



TL 231-SA



120 1 TL 231-SA

Acero inox., anti magnético, anti ácido



Pinzas de precisión para el manipulado de componentes. Puntas rectas para componentes de Ø2.0mm con mangos estriados



TL 577-SA

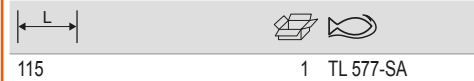

115 1 TL 577-SA

Acero inox, anti-magnético, anti-ácido

Pinzas tipo Boley
Puntas fuertes y finas



TL AA-SA



130 1 TL AA-SA

Acero inox, anti-magnético, anti-ácido

Pinzas con puntas de fibra de carbono
Puntas planas y gruesas



TL 00CFR-SA



130 1 TL 00CFR-SA

Cuerpo de acero inox

Pinzas para manipulado de componentes
Puntas con ángulo 90° para componentes Ø2.0mm con mangos estriados



TL 578-SA



115 1 TL 578-SA

Acero inox, anti-magnético, anti-ácido

Pinzas tipo Boley de
Puntas reforzadas y finas



TL AA-TA



130 1 TL AA-TA

Titanio, anti-magnético, anti-ácido
Super ligeras

Pinzas con puntas de fibra de carbono
Puntas planas y redondeadas



TL 2ACFR-SA



130 1 TL 2ACFR-SA

Cuerpo de acero inox

Pinzas de precisión para el manipulado de componentes. Puntas con ángulo 90° para componentes de Ø1.0mm con mangos estriados



TL 582-SA



115 1 TL 582-SA

Acero inox, anti-magnético, anti-ácido

Pinzas con puntas de fibra de carbono
Puntas laterales planas y gruesas



TL 249CFR-SA

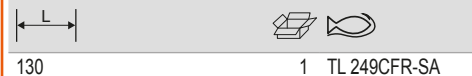

130 1 TL 249CFR-SA

Cuerpo de acero inox

Pinzas con puntas de fibra de carbono
Puntas extrafinas



TL 5CFR-SA



130 1 TL 5CFR-SA

Cuerpo de acero inox

Pinzas tipo Boley
Puntas finas y reforzadas



TL AA-S



130 1 TL AA-S

Acero inox

Pinzas con puntas de fibra de carbono
Puntas extrafinas



TL 259CFR-SA

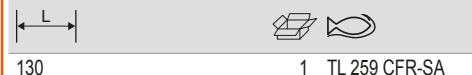

130 1 TL 259CFR-SA

Cuerpo de acero inox

Pinzas con puntas de fibra de carbono
Puntas finas curvadas



TL 7CFR-SA



130 1 TL 7CFR-SA

Cuerpo acero inox

Pinzas con puntas de fibra de carbono
Puntas de 3mm y tipo 2A



TL 269CF-SA



130



1 TL 269CF-SA

Cuerpo acero inox

Puntas de recambio



TL 5ACF



40



1 TL 5ACF

Pinzas SDM



TL SM105-SA



120



1 TL SM 105-SA

Acero inox, anti-magnético, anti-ácido

Puntas de recambio planas y gruesas



TL 249ACF



40



1 TL 249 ACF

Puntas curvas finas de recambio



TL 7ACF



130



1 TL 7ACF

Pinzas SDM



TL SM107-SA



120



1 TL SM 107-SA

Acero inox, anti-magnético, anti-ácido

Puntas de recambio extrafinas



TL 259ACF



40



1 TL 259 ACF

Pinzas SDM



TL SM103-SA



115



1 TL SM 103-SA

Pinzas SDM



TL SM108-SA



120



1 TL SM 108-SA

Puntas de recambio



TL 2AACF



40



1 TL 2AACF

Pinzas SDM



TL SM104-SA



120



1 TL SM 104-SA

Pinzas SDM



TL SM109-SA



120



1 TL SM 109-SA

Acero inox, anti-magnético, anti-ácido



Pinzas SDM



TL SM110-SA



120

1 TL SM 110-SA

Acero inox, anti-magnético, anti-ácido

Pinzas SDM



TL SM111-SA



120

1 TL SM 111-SA

Acero inox, anti-magnético, anti-ácido

Pinzas SDM



TL SM115-SA



120

1 TL SM 115-SA

Acero inox, anti-magnético, anti-ácido

Pinzas SDM



TL SM117-SA



120

1 TL SM 117-SA

Acero inox, anti-magnético, anti-ácido

Juego de pinzas, para componentes CMS
7 pzs



9854



20 x 200 x 180 mm
20 x 200 x 180 mm

1 9854
1 9854W

TL 5C-SA

TL 5-SA-SL

TL SM 107-SA

TL SM 108-SA

TL SM 115-SA

9854W

Juego de 5 pinzas



9855



10 x 200 x 110 mm
10 x 200 x 110 mm

1 9855
1 9855W

9855W

TL SS-SA-SL

TL AA-SA-SL

TL 2A-SA-SL

TL 7A-SA-SL

TL 4-SA-SL

Juego de 4 pinzas, Titanio



9856



10 x 200 x 110 mm

1 9856

TL 3C-TA

TL 3-TA

TL 5-TA

TL AA-TA

Juego de 5 pinzas
5 piezas



9857



10 x 200 x 110 mm

1 9857

TL 00-SA-SL

TL 1-SA-SL

TL 5-SA-SL

TL 7-SA-SL



TL 3C-SA-SL



9855W

Juego de 2 pinzas, Puntas finas



9858



		
8 x 200 x 65 mm	1	9858
8 x 200 x 65 mm	1	9858W



9858W	
TL AA-SA-SL	
TL SS-SA-SL	

Juego de 2 pinzas, Puntas robustas



9859

		
8 x 200 x 65 mm	1	9859



9858W	
TL 00B-SA	
TL 2A-SA-SL	

DESTORNILLADORES DINAMOMÉTRICOS

Destornillador dinamoétrico ajustable antiestático con visor de escala (ESD)





MA500-1 - MA500-3

		
10-80 c	1	MA500-1
40-200 c	1	MA500-2
50-450 c	1	MA500-3

Destornillador dinamoétrico prefijado antiestático con visor de escala (ESD)



PS501

		
4-22 c	1	PS501-1
7-70 c	1	PS501-2
15-170 c	1	PS501-3
45-450 c	1	PS501-4





BAHCO



CUENTA	SUBGRUPO				
1-100-04-1-0	7311518019006	324	20	10	22
1-100-04-1-2	7311518244125	324	20	5	22
1-100-04-2-0	7311518019013	324	20	10	22
1-100-04-2-2	7311518244132	324	20	5	22
1-100-04-3-0	7311518019020	324	20	10	22
1-100-06-1-0	7311518019037	324	20	10	22
1-100-06-1-2	7311518000233	324	20	5	22
1-100-06-2-0	7311518019044	324	20	10	22
1-100-06-2-2	7311518003593	324	20	5	22
1-100-06-3-0	7311518019051	324	20	10	22
1-100-06-3-2	7311518293581	324	20	5	22
1-100-08-1-0	7311518019068	324	20	10	22
1-100-08-1-2	7311518000264	324	20	5	22
1-100-08-2-0	7311518019075	324	20	10	22
1-100-08-2-2	7311518003609	324	20	5	22
1-100-08-3-0	7311518019082	324	20	10	22
1-100-08-3-2	7311518295585	324	20	5	22
1-100-10-1-0	7311518019099	324	20	10	22
1-100-10-1-2	7311518000295	324	20	5	22
1-100-10-2-0	7311518019105	324	20	10	22
1-100-10-2-2	7311518003616	324	20	5	22
1-100-10-3-0	7311518019112	324	20	10	22
1-100-10-3-2	7311518295592	324	20	5	22
1-100-12-1-0	7311518019129	324	20	10	22
1-100-12-1-2	7311518028053	324	20	5	22
1-100-12-2-0	7311518019136	324	20	5	22
1-100-12-2-2	7311518244118	324	20	5	22
1-100-12-3-0	7311518019143	324	20	5	22
1-100-12-3-2	7311518295608	324	20	5	22
1-100-14-1-0	7311518019150	324	20	10	22
1-100-14-2-0	7311518019167	324	20	5	22
1-102-06-2-0	7311518019198	324	20	10	22
1-102-06-3-0	7311518019204	324	20	10	22
1-102-08-1-0	7311518019211	324	20	10	22
1-102-08-2-0	7311518019228	324	20	10	22
1-102-08-3-0	7311518019235	324	20	10	22
1-104-10-2-0	7311518019242	324	20	10	22
1-104-10-3-0	7311518019259	324	20	10	22
1-104-12-2-0	7311518019266	324	20	5	22
1-104-12-3-0	7311518019273	324	20	5	22
1-104-14-3-0	7311518019297	324	20	5	22
1-106-08-1-0	7311518019303	324	20	10	22
1-106-08-1-2	7311518000301	324	20	5	22
1-106-10-1-0	7311518019310	324	20	10	22
1-106-10-1-2	7311518000325	324	20	5	22
1-106-12-1-0	7311518019327	324	20	5	22
1-106-12-1-2	7311518295615	324	20	5	22
1-110-04-1-0	7311518019334	324	20	10	22
1-110-04-2-0	7311518019341	324	20	10	22
1-110-04-3-0	7311518044046	324	20	10	22
1-110-06-1-0	7311518019358	324	20	10	22
1-110-06-1-2	7311518295622	324	20	5	22
1-110-06-2-0	7311518019365	324	20	10	22
1-110-06-2-2	7311518003623	324	20	5	22
1-110-06-3-0	7311518019372	324	20	10	22
1-110-06-3-2	7311518295639	324	20	5	22
1-110-08-1-0	7311518019389	324	20	10	22
1-110-08-1-2	7311518000332	324	20	5	22
1-110-08-2-0	7311518019396	324	20	10	22
1-110-08-2-2	7311518003630	324	20	5	22
1-110-08-3-0	7311518019402	324	20	10	22
1-110-08-3-2	7311518295646	324	20	5	22
1-110-10-1-0	7311518019419	324	20	10	22
1-110-10-1-2	7311518000349	324	20	5	23
1-110-10-2-0	7311518019426	324	20	10	22
1-110-10-2-2	7311518003647	324	20	5	22
1-110-10-3-0	7311518019433	324	20	10	22
1-110-10-3-2	7311518295653	324	20	5	22
1-110-12-1-0	7311518019440	324	20	5	22
1-110-12-1-2	7311518295660	324	20	5	22
1-110-12-2-0	7311518019457	324	20	5	23
1-110-12-2-2	7311518295677	324	20	5	23
1-110-12-3-0	7311518019464	324	20	5	22
1-110-12-3-2	7311518295684	324	20	5	23
1-110-14-1-0	7311518019488	324	20	5	22
1-111-04-1-0	7311518044053	324	20	10	22
1-111-04-2-0	7311518019518	324	20	10	23
1-111-04-3-0	7311518019525	324	20	10	23
1-111-06-1-0	7311518019549	324	20	10	23
1-111-06-2-0	7311518019556	324	20	10	23
1-111-06-2-2	7311518000363	324	20	5	23
1-111-06-3-0	7311518019563	324	20	10	23
1-111-08-1-0	7311518019570	324	20	10	23
1-111-08-2-0	7311518019587	324	20	10	23
1-115-11-3-1	7311518003791	324	20	10	23
1-143-04-1-0	7311518105983	324	20	10	23
1-143-06-1-0	7311518019631	324	20	10	23
1-143-06-1-2	7311518022341	324	20	5	23
1-143-08-1-0	7311518019662	324	20	10	23
1-143-08-1-2	7311518028077	324	20	5	23
1-143-10-1-0	7311518019693	324	20	10	23
1-143-10-1-2	7311518022358	324	20	5	23
1-143-12-1-0	7311518019723	324	20	5	23
1-143-12-1-2	7311518295691	324	20	5	23
1-160-04-1-0	7311518019785	324	20	10	24
1-160-04-1-2	7311518244057	324	20	5	24
1-160-04-2-0	7311518019792	324	20	10	24
1-160-04-2-2	7311518244095	324	20	5	24



CUENTA	SUBGRUPO				
1-160-04-3-0	7311518019808	324	20	10	24
1-160-06-1-0	7311518019815	324	20	10	24
1-160-06-1-2	7311518000370	324	20	5	24
1-160-06-2-0	7311518019822	324	20	10	24
1-160-06-2-2	7311518003685	324	20	5	24
1-160-06-3-0	7311518019839	324	20	10	24
1-160-06-3-2	7311518295707	324	20	5	24
1-160-08-1-0	7311518019846	324	20	10	24
1-160-08-1-2	7311518000394	324	20	5	24
1-160-08-2-0	7311518019853	324	20	10	24
1-160-08-2-2	7311518003692	324	20	5	24
1-160-08-3-0	7311518019860	324	20	10	24
1-160-08-3-2	7311518295714	324	20	5	24
1-160-10-1-0	7311518019877	324	20	10	24
1-160-10-1-2	7311518000400	324	20	5	24
1-160-10-2-0	7311518019884	324	20	10	24
1-160-10-2-2	7311518295721	324	20	5	24
1-160-10-3-0	7311518019891	324	20	10	24
1-160-10-3-2	7311518295738	324	20	5	24
1-160-12-1-0	7311518019907	324	20	5	24
1-160-12-1-2	7311518295745	324	20	5	24
1-160-12-2-0	7311518019914	324	20	5	24
1-160-12-2-2	7311518295752	324	20	5	24
1-160-12-3-0	7314150292059	324	20	5	24
1-160-12-3-2	7311518298005	324	20	5	24
1-170-04-1-0	7311518044060	324	20	10	23
1-170-04-2-0	7311518019945	324	20	10	23
1-170-04-2-2	7311518244088	324	20	5	23
1-170-04-3-0	7311518019952	324	20	10	23
1-170-06-1-0	7311518019969	324	20	10	23
1-170-06-1-2	7311518244071	324	20	5	23
1-170-06-2-0	7311518019976	324	20	10	23
1-170-06-2-2	7311518003715	324	20	5	23
1-170-06-3-0	7311518019983	324	20	10	23
1-170-06-3-2	7311518295769	324	20	5	23
1-170-08-1-0	7311518019990	324	20	10	23
1-170-08-1-2	7311518000417	324	20	5	23
1-170-08-2-0	7311518020002	324	20	10	23
1-170-08-2-2	7311518003722	324	20	5	23
1-170-08-3-0	7311518020019	324	20	10	23
1-170-08-3-2	7311518295783	324	20	5	23
1-170-10-1-0	7311518020026	324	20	10	23
1-170-10-1-2	7311518028107	324	20	5	23
1-170-10-2-0	7311518020033	324	20	10	23
1-170-10-2-2	7311518244064	324	20	5	23
1-170-10-3-0	7311518020040	324	20	10	23
1-170-10-3-2	7311518295806	324	20	5	23
1-170-12-1-0	7311518020057	324	20	5	23
1-170-12-2-0	7311518020064	324	20	5	23
1-210-04-1-0	7311518020071	324	20	10	24
1-210-04-1-2	7311518243944	324	20	5	24
1-210-04-2-0	7311518020088	324	20	10	24
1-210-04-2-2	7311518244040	324	20	5	24
1-210-04-3-0	7311518020095	324	20	10	24
1-210-06-1-0	7311518020101	324	20	10	24
1-210-06-1-2	7311518000424	324	20	5	24
1-210-06-2-0	7311518020118	324	20	10	24
1-210-06-2-2	7311518003654	324	20	5	24
1-210-06-3-0	7311518020125	324	20	10	24
1-210-06-3-2	7311518293574	324	20	5	24
1-210-08-1-0	7311518020132	324	20	10	24
1-210-08-1-2	7311518000455	324	20	5	24
1-210-08-2-0	7311518020149	324	20	10	24
1-210-08-2-2	7311518000479	324	20	5	24
1-210-08-3-0	7311518020156	324	20	10	24
1-210-08-3-2	7311518295837	324	20	5	24
1-210-10-1-0	7311518020163	324	20	10	24
1-210-10-1-2	7311518000493	324	20	5	24
1-210-10-2-0	7311518020170	324	20	10	24
1-210-10-2-2	7311518003661	324	20	5	24
1-210-10-3-0	7311518020187	324	20	10	24
1-210-10-3-2	7311518295844	324	20	5	24
1-210-12-1-0	7311518020194	324	20	5	24
1-210-12-1-2	7311518028121	324	20	5	24
1-210-12-2-0	7311518020200	324	20	5	24
1-210-12-2-2	7311518244149	324	20	5	24
1-210-12-3-0	7311518020217	324	20	5	24
1-210-12-3-2	7311518295851	324	20	5	

1-230-10-2-0

	CUENTA	SUBGRUPO			
1-230-10-2-0	7311518020347	324	20	10	25
1-230-10-2-2	7311518003678	324	20	5	26
1-230-10-3-0	7311518020354	324	20	10	25
1-230-10-3-2	7311518295899	324	20	5	26
1-230-12-1-0	7311518020361	324	20	5	25
1-230-12-1-2	7311518295912	324	20	5	26
1-230-12-2-0	7311518020378	324	20	5	25
1-230-12-2-2	7311518295929	324	20	5	26
1-230-12-3-0	7311518020385	324	20	5	25
1-230-12-3-2	7311518295905	324	20	5	26
1-320-08-2-0	7311518191276	324	20	10	23
1-320-08-2-2	7311518270865	324	20	5	23
1-320-10-2-0	7311518020477	324	20	10	23
1-320-10-2-2	7311518270872	324	20	5	23
1-320-12-2-0	7311518020484	324	20	5	23
1-320-12-2-2	7311518270889	324	20	5	23
1-473-06-2-2	7311518201098	324	20	5	24
1-473-08-2-2	7311518201104	324	20	5	24
1-473-10-2-2	7311518201111	324	20	5	24
1-476-04-3-2	7311518010928	324	20	1	24
1-477-08-2-2	7311518037994	324	20	5	25
1-477-10-2-2	7311518201074	324	20	5	25
1-478-08-1-2	7311518141127	324	20	5	25
1-478-10-1-2	7311518241995	324	20	5	25
1-479-08-1-2	7311518176747	324	20	5	25
1-479-08-2-2	7311518180607	324	20	5	25
10-21-51	7311518229344	316	10	5	567
10-24-23	7311518229368	316	10	5	567
10-24-51	7311518229351	316	10	5	567
10-30-23	7311518229382	316	10	5	567
10-30-51	7311518229375	316	10	5	567
1016	7314150218189	350	46	10	196
1019	8412814010199	350	46	10	196
1031-10	7314150025442	364	30	5	512
1031-12	7314150025459	364	30	5	512
1031-14	7314150025466	364	30	5	512
1031-16	7314150025473	364	30	5	512
1031-18	7314150025480	364	30	5	512
1031-20	7314150025497	364	30	5	512
1031-22	7314150025503	364	30	5	512
1031-25	7314150025510	364	30	5	512
1031-28	7314150025527	364	30	5	512
1031-30	7314150025534	364	30	5	512
1031-32	7314150025541	364	30	5	512
1031-4	7314150025411	364	30	5	512
1031-40	7314150025558	364	30	5	512
1031-6	7314150025428	364	30	5	512
1031-8	7314150025435	364	30	5	512
1067	8412814010670	350	46	10	196
1084	7311518277291	338	15	5	246
10RM-10	7314153014351	366	25	1	46
10RM-13	7314153014368	366	25	1	46
10RM-14	7314150221677	366	25	1	46
10RM-17	7314153014375	366	25	1	46
10RM-19	7314153014382	366	25	1	46
10RM-8	7314153014344	366	25	1	46
10RM/SH6	7314150222971	366	25	1	47
10RZ-1/2	7314150358786	366	25	1	46
10RZ-11/16	7314150358816	366	25	1	46
10RZ-3/4	7314150358823	366	25	1	46
10RZ-3/8	7314150358762	366	25	1	46
10RZ-5/16	7314150358748	366	25	1	46
10RZ-5/8	7314150358809	366	25	1	46
10RZ-7/16	7314150358779	366	25	1	46
10RZ-9/16	7314150358793	366	25	1	46
111M-10	7314151828653	366	10	10	40
111M-100	7314150401499	366	10	1	40
111M-11	7314151828660	366	10	10	40
111M-12	7314151828677	366	10	10	40
111M-13	7314151828684	366	10	10	40
111M-14	7314151828691	366	10	10	40
111M-15	7314151828707	366	10	10	40
111M-16	7314151828714	366	10	10	40
111M-17	7314151828721	366	10	10	40
111M-18	7314151828738	366	10	10	40
111M-19	7314151828745	366	10	10	40
111M-20	7314151828752	366	10	10	40
111M-21	7314151828769	366	10	10	40
111M-22	7314151828776	366	10	5	40
111M-23	7314151828783	366	10	5	40
111M-24	7314151828790	366	10	5	40
111M-25	7314151828806	366	10	5	40
111M-26	7314151828813	366	10	5	40
111M-27	7314151828820	366	10	5	40
111M-28	7314151828837	366	10	5	40
111M-29	7314151828844	366	10	5	40
111M-30	7314151828851	366	10	5	40
111M-32	7314151828868	366	10	5	40
111M-33	7314150222223	366	10	5	40
111M-34	7314151828875	366	10	5	40
111M-36	7314150135516	366	10	1	40
111M-38	7314150222230	366	10	1	40
111M-41	7314150135523	366	10	1	40
111M-46	7314150135530	366	10	1	40
111M-5.5	7314151828608	366	10	10	40
111M-50	7314150135547	366	10	1	40
111M-55	7314150135554	366	10	1	40
111M-6	7314151828615	366	10	10	40

	CUENTA	SUBGRUPO			
111M-60	7314150135561	366	10	1	40
111M-65	7314150135578	366	10	1	40
111M-7	7314151828622	366	10	10	40
111M-70	7314150135585	366	10	1	40
111M-75	7314150135592	366	10	1	40
111M-8	7314151828639	366	10	10	40
111M-80	7314150135608	366	10	1	40
111M-85	7314150352999	366	10	1	40
111M-9	7314151828646	366	10	10	40
111M-90	7314150401475	366	10	1	40
111M-95	7314150401482	366	10	1	40
111M/11T	7314151828899	366	10	1	42
111M/14T	7314151828905	366	10	1	42
111M/17T	7314151828912	366	10	1	42
111M/17TL	7314150197859	366	10	1	42
111M/24T	7314150197866	366	10	1	42
111M/26T	7314151828929	366	10	1	42
111M/S10	7314150212965	366	10	1	41
111M/SH12	7314153013347	366	10	1	41
111M/SH5	7314150325252	366	10	1	41
111M/SH8	7314150197873	366	10	1	41
111Z-1	7314151829063	366	10	3	41
111Z-1.1/16	7314151829070	366	10	5	41
111Z-1.1/2	7314150135752	366	10	1	41
111Z-1.1/4	7314151829094	366	10	5	41
111Z-1.1/8	7314151829087	366	10	5	41
111Z-1.11/16	7314150135615	366	10	1	41
111Z-1.13/16	7314150135639	366	10	1	41
111Z-1.3/4	7314150135622	366	10	1	41
111Z-1.3/8	7314150135738	366	10	1	41
111Z-1.5/16	7314151829100	366	10	5	41
111Z-1.5/8	7314150135769	366	10	1	41
111Z-1.7/16	7314150135745	366	10	1	41
111Z-1.7/8	7314150135646	366	10	1	41
111Z-1/2	7314151828981	366	10	5	41
111Z-1/4	7314151828943	366	10	5	41
111Z-11/16	7314151829018	366	10	5	41
111Z-13/16	7314151829032	366	10	5	41
111Z-15/16	7314151829056	366	10	3	41
111Z-2	7314150135653	366	10	1	41
111Z-2.1/2	7314150135721	366	10	1	41
111Z-2.1/4	7314150135691	366	10	1	41
111Z-2.1/8	7314150135677	366	10	1	41
111Z-2.3/4	7314150135783	366	10	1	41
111Z-2.3/8	7314150135707	366	10	1	41
111Z-2.5/8	7314150135776	366	10	1	41
111Z-2.7/8	7314150135790	366	10	1	41
111Z-3	7314150135806	366	10	1	41
111Z-3/4	7314151829025	366	10	5	41
111Z-3/8	7314151828967	366	10	5	41
111Z-5/16	7314151828950	366	10	5	41
111Z-5/8	7314151829001	366	10	5	41
111Z-7/16	7314151828974	366	10	5	41
111Z-7/8	7314151829049	366	10	5	41
111Z-9/16	7314151828998	366	10	5	41
111Z/11T	7314151829124	366	10	1	42
111Z/8T	7314151829117	366	10	1	42
1150-1/2H/P	7314150129263	336	20	1	488
1150D	7311518276614	336	20	1	488
1154	7314150249831	312	25	1	297
1154-DG	7314150249800	312	25	1	297
1154-MB	7314150249817	312	25	1	297
1157	7311518277031	358	15	20	544
1162N-1/2	7314151847241	336	15	1	482
1175-1	7314150106943	338	10	1	244
1175-11/2	7314150103768	338	10	1	244
1177-SCRIBE	7314150120550	336	10	5	487
1178-SCRIBE	7314150120567	336	10	5	487
1179-FLX	7311518276997	336	15	100	484
1179-SCRIBE	7314150120574	336	10	5	487
1179-TIPS	7314150120581	336	10	1	487
11M-10	7314151829155	366	10	5	43
11M-11	7314151829162	366	10	5	43
11M-12	7314151829179	366	10	5	43
11M-13	7314151829186	366	10	5	43
11M-14	7314151829193	366	10	5	43
11M-15	7314151829209	366	10	5	43
11M-16	7314151829216	366	10	5	43
11M-17	7314151829223	366	10	5	43
11M-18	7314151829230	366	10	5	43
11M-19	7314151829247	366	10	5	43
11M-21	7314151829254	366	10	5	43
11M-22	7314151829261	366	10	5	43
11M-24	7314151829278	366	10	5	43
11M-27	7314151829285	366	10	1	43
11M-30	7314151829292	366	10	1	43
11M-32	7314151829308	366	10	1	43
11M-36	7314151829315	366	10	1	43
11M-38	7314151829322	366	10	1	43
11M-8	7314151829131	366	10	5	43
11M-9	7314151829148	366	10	5	



CUENTA SUBGRUPO



11Z-3/8	7314150355211	366	10	5	43
11Z-5/8	7314150355259	366	10	5	43
11Z-7/16	7314150355228	366	10	5	43
11Z-9/16	7314150355242	366	10	5	43
1300Z-1-1/8	7314150300989	366	10	1	53
1300Z-1/2-9/16	7314151039998	366	10	1	53
1300Z-1/4-5/16	7314150300965	366	10	1	53
1300Z-15/16-1	7314150305656	366	10	1	53
1300Z-19/32-11/16	7314151040000	366	10	1	53
1300Z-25/32-13/16	7314150300972	366	10	1	53
1300Z-3/8-7/16	7314151039981	366	10	1	53
1300Z-5/8-3/4	7314151040017	366	10	1	53
1300Z-7/8-15/16	7314150305649	366	10	1	53
1320RM-10-11	7314153014511	366	25	1	47
1320RM-12-13	7314153014528	366	25	1	47
1320RM-14-15	7314153014535	366	25	1	47
1320RM-16-17	7314153014542	366	25	1	47
1320RM-17-19	7314150359196	366	25	1	47
1320RM-18-19	7314153014559	366	25	1	47
1320RM-22-24	7314150221646	366	25	1	47
1320RM-6-7	7314153014498	366	25	1	47
1320RM-8-9	7314153014504	366	25	1	47
1320RM/SH8	7314150222988	366	25	1	48
1320RZ-1/2-9/16	7314153014580	366	25	1	47
1320RZ-1/4-5/16	7314153014566	366	25	1	47
1320RZ-3/4-13/16	7314150359264	366	25	1	47
1320RZ-3/4-7/8	7314150359271	366	25	1	47
1320RZ-3/8-7/16	7314153014573	366	25	1	47
1320RZ-5/8-11/16	7314150359257	366	25	1	47
1320RZ-7/8-15/16	7314150359288	366	25	1	47
1320SRM-14-19	7314150190355	366	25	1	48
1320SRM/S29	7314150188673	366	25	1	48
1321RZ-1/2-9/16	7314150359349	366	25	1	48
1321RZ-3/4-7/8	7314150359363	366	25	1	48
1321RZ-3/8-7/16	7314150359332	366	25	1	48
1321RZ-5/8-11/16	7314150359356	366	25	1	48
133SGM-100	7314151828523	366	20	1	57
133SGM-105	7314151828530	366	20	1	57
133SGM-110	7314151828547	366	20	1	57
133SGM-115	7314151828554	366	20	1	57
133SGM-120	7314151828561	366	20	1	57
133SGM-27	7314151828363	366	20	1	56
133SGM-30	7314151828370	366	20	1	56
133SGM-32	7314151828387	366	20	1	56
133SGM-36	7314151828394	366	20	1	56
133SGM-41	7314151828400	366	20	1	56
133SGM-46	7314151828417	366	20	1	56
133SGM-50	7314151828424	366	20	1	56
133SGM-55	7314151828431	366	20	1	57
133SGM-60	7314151828448	366	20	1	57
133SGM-65	7314151828455	366	20	1	57
133SGM-70	7314151828462	366	20	1	57
133SGM-75	7314151828479	366	20	1	57
133SGM-80	7314151828486	366	20	1	57
133SGM-85	7314151828493	366	20	1	57
133SGM-90	7314151828509	366	20	1	57
133SGM-95	7314151828516	366	20	1	57
14-24-38/10	7311518002879	316	10	5	568
140	7314150008797	338	12	1	244
141	7314150008827	338	12	1	244
1410	7314150106332	338	12	1	244
1411-3.2	7314151040437	322	15	1	341
1411AUP8	7314150205936	322	15	1	341
1411AUP81	7314150230839	322	15	1	342
1411AUP82	7314150230846	322	15	1	342
1411AUP83	7314150230853	322	15	1	342
1411AUP84	7314150230860	322	15	1	342
1412-4.8	7314151040444	322	15	1	341
1413-6.4	7314151040451	322	15	1	341
1414-8	7314151040468	322	15	1	341
1415-8.7	7314151040475	322	15	1	341
1418A	7314151040505	322	15	1	341
1418B	7314151040512	322	15	1	341
1418C	7314151040529	322	15	1	341
1418D	7314151040536	322	15	1	341
1418E	7314151040543	322	15	1	341
1418F	7314151040550	322	15	1	341
1418G	7314151040567	322	15	1	341
1418H	7314151040574	322	15	1	341
1418I	7314151040581	322	15	1	341
1418K	7314151040598	322	15	1	341
1418S	7314151040604	322	15	1	341
1419-M12	7314150257423	322	35	1	341
1419-M16	7314150358045	322	35	1	341
1419-M5	7314150257409	322	35	1	341
1419-M8	7314150257416	322	35	1	341
1419-MD	7311518277352	312	40	1	313
1419/4	7314150125036	322	15	1	341
142	7314150008841	338	12	1	244
1420	7314150103744	338	12	1	244
1420-1.4	7314151696337	322	15	1	340
1421-2.1	7314151696412	322	15	1	340
1422-3.1	7314151696689	322	15	1	340
1423-4.8	7314151696764	322	15	1	340
1424-6.2	7314151696849	322	15	1	340
143	7314150008872	338	12	1	244
1430FT120	7314150342006	356	15	1	352
1435/5	7314151040734	322	15	1	340



CUENTA SUBGRUPO



1435/8	7314151040741	322	15	1	341
144	7314150008902	338	12	1	244
1446	7314150128631	334	10	15	523
1446-OV	7314150313679	334	10	15	523
1450D-ISO	7314151040970	322	30	1	342
1450D-WW	7314151040987	322	30	1	342
1450D/2	7314151040963	322	30	1	342
1460M/1	7314151041090	322	30	1	342
1460M/2	7314151041106	322	30	1	342
1460Z/2	7314151041120	322	30	1	342
1467-250	7314150124268	340	93	1	239
1467-320-850	7314150178636	340	93	1	240
1467-520	7314150124275	340	93	1	240
1467-B14	7314150301645	340	93	1	240
1467-L3,2	7314150209071	340	93	1	240
1467-L4	7314150209057	340	93	1	240
1467-L5	7314150209040	340	93	1	240
1467-L6	7314150209064	340	93	1	240
1467-L6,4	7314150209088	340	93	1	240
1467-LJ	7314150209033	340	93	1	240
1467-S2,4	7314150209026	340	93	1	240
1467-S3,2	7314150209019	340	93	1	240
1467-S4	7314150209002	340	93	1	240
1467-S5	7314150208999	340	93	1	240
1467-SJ	7314150208982	340	93	1	240
1468-10-1	7314150342471	340	93	1	320
1468-10M10	7314150243457	340	93	1	320
1468-10M4	7314150243419	340	93	1	320
1468-10M5	7314150243426	340	93	1	320
1468-10M6	7314150243433	340	93	1	320
1468-10M8	7314150243440	340	93	1	320
1468-6M3	7314150243372	340	93	1	319
1468-6M4	7314150243389	340	93	1	319
1468-6M5	7314150243396	340	93	1	319
1468-6M6	7314150243402	340	93	1	319
1468-M10	7314150243228	340	93	1	319
1468-M6	7314150243211	340	93	1	319
147	7314150008933	338	10	1	244
147-1	7314150367047	360	15	1	126
147-1.1/4	7314150367061	360	15	1	126
147-1.1/8	7314150367054	360	15	1	126
147-1/2	7314150366965	360	15	1	126
147-11/16	7314150366996	360	15	1	126
147-13	7314150366644	360	15	1	125
147-13/16	7314150367016	360	15	1	126
147-14	7314150366651	360	15	1	125
147-15	7314150366668	360	15	1	125
147-15/16	7314150367030	360	15	1	126
147-16	7314150366675	360	15	1	125
147-17	7314150366682	360	15	1	125
147-18	7314150366699	360	15	1	125
147-19	7314150366705	360	15	1	125
147-21	7314150366712	360	15	1	125
147-22	7314150366729	360	15	1	125
147-24	7314150366736	360	15	1	125
147-25	7314150366743	360	15	1	125
147-27	7314150366750	360	15	1	125
147-3/4	7314150367009	360	15	1	126
147-30	7314150366767	360	15	1	125
147-32	7314150366774	360	15	1	125
147-33	7314150366781	360	15	1	125
147-34	7314150366798	360	15	1	125
147-35	7314150366804	360	15	1	125
147-36	7314150366811	360	15	1	125
147-37	7314150366828	360	15	1	125
147-38	7314150366835	360	15	1	125
147-39	7314150366842	360	15	1	125
147-41	7314150366859	360	15	1	125
147-45	7314150366866	360	15	1	125
147-46	7314150366873	360	15	1	125
147-5/8	7314150366989	360	15	1	126
147-50	7314150366880	360	15	1	125
147-55	7314150366897	360	15	1	126
147-60	7314150366903	360	15	1	126
147-68	7314150366910	360	15	1	126
147-7/16	7314150366958	360	15	1	126
147-7/8	7314150367023	360	15	1	126
147-70	7314150366927	360	15	1	126
147-75	7314150366934	360	15	1	126
147-9/16	7314150366972	360	15	1	126
147-90	7314150366941	360	15	1	126
1470K-AC1	7314150226498	356	10	1	350
1470K-AC2	7314150226504	356	10	1	350
1470K-AC3	7314150226511	356	10	1	350
1470K-AC4	7314150226528	356	10	1	351
1470K-AC7	7314150271320	356	10	1	351
1470K-AC8	7314150328581	356	20	1	351

1470KCTRAY



CUENTA	SUBGRUPO				
1470KCTRAY	7314150226702	356	10	1	352
1470KXL-ACTD	7314150297290	356	10	1	351
1470KXL-ACTSS	7314150297313	356	10	1	351
1470KXL-ACTW	7314150297306	356	10	1	351
1470KXLC-TRAY	7314150285549	356	10	1	351
1472K-ACTD	7314150399345	356	10	1	350
1472K-ACTSS	7314150399338	356	10	1	350
1472K-ACTW	7314150393152	356	10	1	350
1472K5	7314150349463	356	10	1	346
1472K5BLACK	7314150349500	356	10	1	346
1472K5BLUE	7314150349616	356	10	1	346
1472K5RED	7314150349562	356	10	1	346
1472K6	7314150349470	356	10	1	346
1472K6BLACK	7314150349531	356	10	1	346
1472K6BLUE	7314150349623	356	10	1	346
1472K6RED	7314150349579	356	10	1	346
1472K7	7314150349487	356	10	1	346
1472K7BLACK	7314150349548	356	10	1	346
1472K7BLUE	7314150349630	356	10	1	346
1472K7RED	7314150349586	356	10	1	346
1472K8	7314150349494	356	10	1	346
1472K8BLACK	7314150349555	356	10	1	346
1472K8BLUE	7314150349647	356	10	1	346
1472K8RED	7314150349593	356	10	1	346
1475K6	7314150349654	356	10	1	347
1475K6BLACK	7314150349685	356	10	1	347
1475K6BLUE	7314150349760	356	10	1	347
1475K6RED	7314150349715	356	10	1	347
1475K7	7314150349661	356	10	1	347
1475K7BLACK	7314150349692	356	10	1	347
1475K7BLUE	7314150349814	356	10	1	347
1475K7RED	7314150349746	356	10	1	347
1475K8	7314150349678	356	10	1	347
1475K8BLACK	7314150349708	356	10	1	347
1475K8BLUE	7314150349821	356	10	1	347
1475K8RED	7314150349753	356	10	1	347
1475KXL12	7314150350223	356	10	1	346
1475KXL12BLACK	7314150350230	356	10	1	346
1475KXL6	7314150349968	356	10	1	347
1475KXL6BLACK	7314150349999	356	10	1	347
1475KXL6BLUE	7314150350162	356	10	1	347
1475KXL6C	7314150350193	356	10	1	347
1475KXL6CBLACK	7314150350209	356	10	1	347
1475KXL6RED	7314150350124	356	10	1	347
1475KXL7	7314150349975	356	10	1	347
1475KXL7BLACK	7314150350070	356	10	1	347
1475KXL7BLUE	7314150350179	356	10	1	347
1475KXL7RED	7314150350148	356	10	1	347
1475KXL7S	7314150349517	356	10	1	468
1475KXL8	7314150349982	356	10	1	347
1475KXL8BLACK	7314150350094	356	10	1	347
1475KXL8BLUE	7314150350186	356	10	1	347
1475KXL8RED	7314150350155	356	10	1	347
1475KXL8CWTSS	7314150400157	356	10	1	347
1477K-AC10	7314150353163	356	20	1	349
1477K-AC11	7314150369874	356	10	1	350
1477K-AC12	7314150369195	356	10	1	348
1477K-AC13	7314150369218	356	10	1	348
1477K-AC14	7314150369225	356	10	1	348
1477K-AC15	7314150369249	356	10	1	349
1477K-AC16	7314150369256	356	10	1	349
1477K-AC17	7314150369270	356	10	1	348
1477K-AC18	7314150369287	356	10	1	348
1477K-AC19	7314150369676	356	10	1	348
1477K-AC20	7314150369683	356	10	1	348
1477K-AC21	7314150370412	356	10	1	349
1477K-AC22	7314150369706	356	10	1	349
1477K-AC23	7314150369867	356	10	1	350
1477K-AC24	7314150370429	356	10	1	349
1477K-AC25	7314150370436	356	10	1	349
1477K-AC28	7314150370481	356	10	1	349
1477K-AC29	7314150370498	356	10	1	349
1477K-ACTD	7314150370474	356	10	1	350
1477K-ACTP	7314150383764	356	35	1	349
1477K-ACTSS	7314150370450	356	10	1	350
1477K-ACTW	7314150370467	356	10	1	350
1477K6	7314150350391	356	10	1	346
1477K6BLACK	7314150351091	356	10	1	346
1477K6GREY	7314150351138	356	10	1	346
1477K7	7314150350407	356	10	1	346
1477K7BLACK	7314150351107	356	10	1	346
1477K7GREY	7314150351145	356	10	1	346
1477K8	7314150350414	356	10	1	346
1477K8BLACK	7314150351114	356	10	1	346
1477K8GREY	7314150351183	356	10	1	346
1477K9	7314150350940	356	10	1	346
1477K9BLACK	7314150351121	356	10	1	346
1477K9GREY	7314150351190	356	10	1	346
148-1	7314150367801	360	15	1	127
148-1/2	7314150367726	360	15	1	127
148-11/16	7314150367757	360	15	1	127
148-13	7314150367559	360	15	1	126
148-13/16	7314150367771	360	15	1	127
148-14	7314150367566	360	15	1	126
148-15	7314150367573	360	15	1	126
148-15/16	7314150367795	360	15	1	127
148-16	7314150367580	360	15	1	126
148-17	7314150367597	360	15	1	126



148-18	7314150367603	360	15	1	126
148-19	7314150367610	360	15	1	126
148-21	7314150367627	360	15	1	126
148-22	7314150367634	360	15	1	126
148-24	7314150367641	360	15	1	126
148-27	7314150367658	360	15	1	126
148-28	7314150367665	360	15	1	126
148-3/4	7314150367764	360	15	1	127
148-30	7314150367672	360	15	1	126
148-32	7314150367689	360	15	1	126
148-34	7314150367696	360	15	1	126
148-36	7314150367702	360	15	1	126
148-41	7314150367719	360	15	1	126
148-5/8	7314150367740	360	15	1	127
148-7/8	7314150367788	360	15	1	127
148-9/16	7314150367733	360	15	1	127
1483CART	7314150273256	356	15	1	395
1483K2RB	7314150230013	356	15	1	395
1483K3RB	7314150230037	356	15	1	395
1483KHD3RB	7314150230099	356	15	1	395
1483KHD4RB	7314150230105	356	15	1	395
1485K4	7314150349838	356	10	1	348
1485K4BLACK	7314150349920	356	10	1	348
1485K4BLUE	7314150349944	356	10	1	348
1485K4RED	7314150349937	356	10	1	348
1485KXL4	7314150350247	356	10	1	348
1485KXL4BLACK	7314150350346	356	10	1	348
1485KXL4BLUE	7314150350360	356	10	1	348
1485KXL4RED	7314150350353	356	10	1	348
1487K4	7314150351206	356	10	1	347
1487K4BLACK	7314150351213	356	10	1	347
1487K4GREY	7314150351237	356	10	1	347
1495CD-AC1	7314150296965	356	20	1	393
1495CD60	7314150296927	356	20	1	393
1495CD60BK	7314150326952	356	20	1	393
1495CD60BL	7314150326969	356	20	1	393
1495CD60RED	7314150326976	356	20	1	393
1495CD60TS1	7314150325627	356	20	1	403
1495CD60W	7314150303656	356	20	1	393
1495CD60WBK	7314150327713	356	20	1	393
1495CD60WBL	7314150327720	356	20	1	393
1495CD60WRED	7314150327744	356	20	1	393
1495CS-AC1	7314150296910	356	20	1	393
1495CS15	7314150296934	356	20	1	393
1495CS15BK	7314150326853	356	20	1	393
1495CS15BL	7314150326860	356	20	1	393
1495CS15RED	7314150326877	356	20	1	393
1495CS15TS1	7314150325610	356	20	1	403
1495CS18	7314150296941	356	20	1	393
1495CS18BK	7314150326884	356	20	1	393
1495CS18BL	7314150326891	356	20	1	393
1495CS18RED	7314150326907	356	20	1	393
1495CS18TS1	7314150325603	356	20	1	403
1495FWB097TD	7314150296675	356	20	1	392
1495FWB097TS	7314150296651	356	20	1	392
1495FWB120TD	7314150296682	356	20	1	392
1495FWB120TS	7314150296668	356	20	1	392
1495K6CBKWB15TD	7314150369072	356	20	1	391
1495K6CBKWB15TS	7314150368990	356	20	1	390
1495K6CBKWB15TW	7314150369034	356	20	1	391
1495K6CBKWB18TD	7314150369690	356	20	1	391
1495K6CBKWB18TS	7314150369591	356	20	1	390
1495K6CBKWB18TW	7314150369638	356	20	1	391
1495K6CBLWB15TD	7314150369317	356	20	1	391
1495K6CBLWB15TS	7314150369119	356	20	1	390
1495K6CBLWB15TW	7314150369232	356	20	1	391
1495K6CBLWB18TD	7314150369829	356	20	1	391
1495K6CBLWB18TS	7314150369744	356	20	1	390
1495K6CBLWB18TW	7314150369782	356	20	1	391
1495K6CRDWB15TD	7314150368969	356	20	1	391
1495K6CRDWB15TS	7314150368600	356	20	1	390
1495K6CRDWB15TW	7314150368655	356	20	1	391
1495K6CRDWB18TD	7314150369553	356	20	1	391
1495K6CRDWB18TS	7314150369478	356	20	1	390
1495K6CRDWB18TW	7314150369515	356	20	1	391
1495K6CWB15TD	7314150368563	356	20	1	391
1495K6CWB15TS	7314150368440	356	20	1	390
1495K6CWB15TW	7314150368501	356	20	1	391
1495K6CWB18TD	7314150369430	356	20	1	391
1495K6CWB18TS	7314150369355	356	20	1	390
1495K6CWB18TW	7314150369393	356	20	1	391
1495K7CBKWB15TD	7314150369089	356	20	1	391
1495K7CBKWB15TS	7314150369003	356	20	1	390
1495K7CBKWB15TW	7314150369041	356	20	1	391
1495K7CBKWB18TD	7314150369713	356	20	1	391
1495K7CBKWB18TS	7314150369607	356	20	1	390
1495K7CBKWB18TW	7314150369645	356	20	1	391
1495K7CBLWB15TD	7314150369324	356			



1495K7CRDWB18TW	7314150369522	356	20	1	391
1495K7CWB15TD	7314150368570	356	20	1	391
1495K7CWB15TS	7314150368464	356	20	1	390
1495K7CWB15TW	7314150368518	356	20	1	391
1495K7CWB18TD	7314150369447	356	20	1	391
1495K7CWB18TS	7314150369362	356	20	1	390
1495K7CWB18TW	7314150369409	356	20	1	391
1495K8CBKWB15TD	7314150369096	356	20	1	391
1495K8CBKWB15TS	7314150369010	356	20	1	390
1495K8CBKWB15TW	7314150369058	356	20	1	391
1495K8CBKWB18TD	7314150369720	356	20	1	391
1495K8CBKWB18TS	7314150369614	356	20	1	390
1495K8CBKWB18TW	7314150369652	356	20	1	391
1495K8CBLWB15TD	7314150369331	356	20	1	391
1495K8CBLWB15TS	7314150369188	356	20	1	390
1495K8CBLWB15TW	7314150369294	356	20	1	391
1495K8CBLWB18TD	7314150369843	356	20	1	391
1495K8CBLWB18TS	7314150369768	356	20	1	390
1495K8CBLWB18TW	7314150369805	356	20	1	391
1495K8CRDWB15TD	7314150368945	356	20	1	391
1495K8CRDWB15TS	7314150368631	356	20	1	390
1495K8CRDWB15TW	7314150368693	356	20	1	391
1495K8CRDWB18TD	7314150369577	356	20	1	391
1495K8CRDWB18TS	7314150369492	356	20	1	390
1495K8CRDWB18TW	7314150369539	356	20	1	391
1495K8CWB15TD	7314150368587	356	20	1	391
1495K8CWB15TS	7314150368471	356	20	1	390
1495K8CWB18TD	7314150369454	356	20	1	391
1495K8CWB18TS	7314150370061	356	20	1	390
1495K8CWB18TW	7314150369416	356	20	1	391
1495KWB15TD	7314150296637	356	20	1	391
1495KWB15TS	7314150338115	356	20	1	391
1495KWB15TW	7314150296613	356	20	1	391
1495KWB18TD	7314150296644	356	20	1	391
1495KWB18TS	7314150338122	356	20	1	391
1495KWB18TW	7314150296620	356	20	1	391
1495TP-AC1	7314150297030	356	20	1	393
1495TP-AC10	7314150297207	356	20	1	393
1495TP-AC11	7314150297214	356	20	1	394
1495TP-AC12	7314150297221	356	20	1	394
1495TP-AC13	7314150297238	356	20	1	394
1495TP-AC2	7314150297122	356	20	1	394
1495TP-AC3	7314150297139	356	20	1	394
1495TP-AC4	7314150297146	356	20	1	394
1495TP-AC5	7314150297153	356	20	1	394
1495TP-AC6	7314150297160	356	20	1	394
1495TP-AC7	7314150297177	356	20	1	394
1495TP-AC8	7314150297184	356	20	1	394
1495TP-AC9	7314150297191	356	20	1	394
1495TP-ACHL20	7314150297047	356	20	5	394
1495TP-ACHL40	7314150297054	356	20	5	394
1495TP-ACHL65	7314150297061	356	20	5	394
1495TP-ACHL90	7314150297078	356	20	1	394
1495TP-ACHU20	7314150297085	356	20	1	394
1495TP-ACHU40	7314150297092	356	20	1	395
1495TP-ACHU65	7314150297108	356	20	1	395
1495TP-ACHU90	7314150297115	356	20	1	395
1495TP06	7314150296989	356	20	1	393
1495TP06GR	7314150326914	356	20	1	393
1495TP10W	7314150297023	356	20	1	393
1495TP12	7314150296996	356	20	1	393
1495TP12GR	7314150326921	356	20	1	393
1495TP15	7314150297009	356	20	1	393
1495TP15GR	7314150326938	356	20	1	393
1495TP18	7314150297016	356	20	1	393
1495TP18GR	7314150326945	356	20	1	393
1495WB15-AC1	7314150296590	356	20	1	392
1495WB15-AC1GR	7314150327218	356	20	1	392
1495WB15TD	7314150296521	356	20	1	392
1495WB15TDGR	7314150327133	356	20	1	392
1495WB15TS	7314150296514	356	20	1	392
1495WB15TSBK	7314150326983	356	20	1	392
1495WB15TSBL	7314150326990	356	20	1	392
1495WB15TSRED	7314150327003	356	20	1	392
1495WB15TW	7314150296538	356	20	1	392
1495WB15TWGR	7314150327140	356	20	1	392
1495WB18-AC1	7314150296606	356	20	1	392
1495WB18-AC1GR	7314150327225	356	20	1	392
1495WB18TD	7314150296552	356	20	1	392
1495WB18TDGR	7314150327157	356	20	1	392
1495WB18TS	7314150296545	356	20	1	392
1495WB18TSBK	7314150327010	356	20	1	392
1495WB18TSBL	7314150327027	356	20	1	392
1495WB18TSRED	7314150327034	356	20	1	392
1495WB18TW	7314150296569	356	20	1	392
1495WB18TWGR	7314150327164	356	20	1	392
1495WBAH15TD	7314150312993	356	20	1	392
1495WBAH15TDGR	7314150327171	356	20	1	392
1495WBAH15TS	7314150313006	356	20	1	392
1495WBAH15TSBK	7314150327041	356	20	1	392
1495WBAH15TSBL	7314150327058	356	20	1	392
1495WBAH15TSRED	7314150327065	356	20	1	392
1495WBAH15TW	7314150313013	356	20	1	392
1495WBAH15TWGR	7314150327195	356	20	1	392
1495WBAH18TD	7314150313037	356	20	1	392
1495WBAH18TDGR	7314150327188	356	20	1	392
1495WBAH18TS	7314150313044	356	20	1	392
1495WBAH18TSBK	7314150327089	356	20	1	392



1495WBAH18TSBL	7314150327119	356	20	1	392
1495WBAH18TSRED	7314150327126	356	20	1	392
1495WBAH18TW	7314150313051	356	20	1	392
1495WBAH18TWGR	7314150327201	356	20	1	392
1496MB2	7314150273478	356	15	1	395
1496MB3	7314150273485	356	15	1	395
1496MB4	7314150273492	356	15	1	395
1496MB5	7314150273508	356	15	1	395
1497MBF350	7314150321391	356	15	1	396
1497MBF550	7314150321407	356	15	1	396
1497MBF750	7314150321414	356	15	1	396
1497MBW	7314150330164	356	15	1	396
14A-32	7314150368228	360	15	1	124
14A-9	7314150368211	360	15	1	124
14F-1/2	7314150366200	360	15	1	125
14F-3/4	7314150366217	360	15	1	125
14P-1/2	7314150366064	360	15	1	124
14Q-1/2	7314150366026	360	15	1	125
14R-1/2	7314150365920	360	15	1	124
14R-3/4	7314150365937	360	15	1	124
14T-1/2	7314150366125	360	15	1	124
14T-3/4	7314150366132	360	15	1	124
14W	7314150357031	360	15	1	124
1519 D	7314150032747	340	15	3	215
1519-9	7314150026074	340	15	1	215
1520 D	7311518278922	340	15	5	211
1520 G	7311518266516	340	15	5	211
1537	7314150214822	336	20	1	488
1544	7311518276560	336	20	1	488
1546	7314150214792	336	20	1	488
1547	7311518276577	336	20	25	488
158-N	7311518277239	340	55	12	220
158-NB	7311518277246	340	55	12	222
1610	7314150404186	338	12	1	244
1610-NUT	7314150409594	338	12	1	244
1620	7314150404193	338	12	1	244
1620-NUT	7314150409754	338	12	1	244
166-6-16-2.5-12	7311518021979	324	15	12	32
166-6-16-2.5-2	7311518209698	324	15	5	32
167-1	7314150419067	360	15	1	128
167-1.1/16	7314150419074	360	15	1	128
167-1.1/4	7314150419104	360	15	1	128
167-1.1/8	7314150419081	360	15	1	128
167-1.3/16	7314150419098	360	15	1	128
167-1/2	7314150418930	360	15	1	128
167-10	7314150418657	360	15	1	128
167-11	7314150418664	360	15	1	128
167-11/16	7314150419364	360	15	1	128
167-12	7314150418671	360	15	1	128
167-13	7314150418688	360	15	1	128
167-13/16	7314150419036	360	15	1	128
167-14	7314150418695	360	15	1	128
167-15	7314150418701	360	15	1	128
167-15/16	7314150419050	360	15	1	128
167-16	7314150418718	360	15	1	128
167-17	7314150418725	360	15	1	128
167-18	7314150418732	360	15	1	128
167-19	7314150418749	360	15	1	128
167-20	7314150418763	360	15	1	128
167-21	7314150418770	360	15	1	128
167-22	7314150418787	360	15	1	128
167-23	7314150418794	360	15	1	128
167-24	7314150418800	360	15	1	128
167-25	7314150418817	360	15	1	128
167-26	7314150418824	360	15	1	128
167-27	7314150418831	360	15	1	128
167-28	7314150418848	360	15	1	128
167-3/4	7314150419029	360	15	1	128
167-3/8	7314150418909	360	15	1	128
167-30	7314150418855	360	15	1	128
167-32	7314150418862	360	15	1	128
167-36	7314150418866	360	15	1	128
167-5/16	7314150418893	360	15	1	128
167-5/8	7314150419012	360	15	1	128
167-7	7314150418619	360	15	1	128
167-7/16	7314150418916	360	15	1	128
167-7/8	7314150419043	360	15	1	128
167-8	7314150418626	360	15	1	128
167-8-21-3.2-12	7311518021986	324	15	12	32
167-9	7314150418640	360	15	1	128
167-9/16	7314150419005	360	15	1	128
168-1	7314150419562	360	15	1	129
168-1.1/16	7314150419579	360	15	1	129
168-1.3/16	7314150419586	360	15	1	129
168-1/2	7314150419487	360	15	1	129
168-10	7314150419272	360	15	1	128
168-11	7314150419289	360	15	1	128
168-11/16	7314150419517	360	1		



CUENTA SUBGRUPO



168-20	7314150419388	360	15	1	128
168-21	7314150419395	360	15	1	128
168-22	7314150419401	360	15	1	128
168-23	7314150419418	360	15	1	128
168-24	7314150419425	360	15	1	128
168-26	7314150419432	360	15	1	128
168-27	7314150419449	360	15	1	128
168-3/4	7314150419524	360	15	1	129
168-3/8	7314150419463	360	15	1	129
168-5/16	7314150419456	360	15	1	129
168-5/8	7314150419500	360	15	1	129
168-6-3.2-1P	7311518152338	324	10	12	32
168-6-3.2-3P	7311518152413	324	10	12	32
168-6-3.5-1P	7311518152345	324	10	12	32
168-6-3.5-3P	7311518152420	324	10	12	32
168-7	7314150419241	360	15	1	128
168-7/16	7314150419470	360	15	1	129
168-7/8	7314150419548	360	15	1	129
168-8	7314150419258	360	15	1	128
168-8-4.0-1P	7311518152352	324	10	12	32
168-8-4.0-3P	7311518152437	324	10	12	32
168-8-4.0-6	7311518217419	324	10	6	33
168-8-4.5-1P	7311518152369	324	10	12	32
168-8-4.5-3P	7311518152444	324	10	12	32
168-8-4.5-6	7311518217426	324	10	6	33
168-8-4.8-1P	7311518152376	324	10	12	32
168-8-4.8-3P	7311518152451	324	10	12	32
168-8-4.8-6	7311518217433	324	10	6	33
168-8-5.2-1P	7311518152383	324	10	12	32
168-8-5.2-3P	7311518152468	324	10	12	32
168-8-5.2-6	7311518217440	324	10	6	33
168-8-5.5-1P	7311518152390	324	10	12	32
168-8-5.5-3P	7311518152475	324	10	12	32
168-8-5.5-6	7311518217457	324	10	6	33
168-8-6.3-1P	7311518152406	324	10	12	32
168-8-6.3-3P	7311518152482	324	10	12	32
168-9	7314150419265	360	15	1	128
168-9/16	7314150419494	360	15	1	129
168-COMBI-4.0	7311518209667	324	10	10	33
168-COMBI-4.0-6922	7311518209612	324	10	10	33
168-COMBI-4.5	7314150272860	324	10	10	33
168-COMBI-4.8	7311518209674	324	10	10	33
168-COMBI-4.8-6920	7311518209643	324	10	10	33
168-COMBI-5.5	7311518209681	324	10	10	33
168-COMBI-5.5-6924	7311518209650	324	10	10	33
169-10	7314150419630	360	15	1	129
169-11	7314150419647	360	15	1	129
169-12	7314150419654	360	15	1	129
169-13	7314150419661	360	15	1	129
169-14	7314150419678	360	15	1	129
169-15	7314150419715	360	15	1	129
169-16	7314150419722	360	15	1	129
169-17	7314150419739	360	15	1	129
169-18	7314150419746	360	15	1	129
169-19	7314150419753	360	15	1	129
169-20	7314150419760	360	15	1	129
169-21	7314150419777	360	15	1	129
169-22	7314150419784	360	15	1	129
169-23	7314150419791	360	15	1	129
169-24	7314150419807	360	15	1	129
169-27	7314150419814	360	15	1	129
169-7	7314150419609	360	15	1	129
169-8	7314150419616	360	15	1	129
169-9	7314150419623	360	15	1	129
16F-1/2	7314150418565	360	15	1	127
16F-1/4	7314150418541	360	15	1	127
16F-3/8	7314150418558	360	15	1	127
16R-1/2	7314150418602	360	15	1	127
16R-1/4	7314150418589	360	15	1	127
16R-3/8	7314150418596	360	15	1	127
1931M-10	7314151049256	366	10	5	49
1931M-11	7314151049263	366	10	5	49
1931M-12	7314151049270	366	10	5	49
1931M-13	7314151049287	366	10	5	49
1931M-14	7314151049294	366	10	5	49
1931M-17	7314151049324	366	10	5	49
1931M-4	7314151049171	366	10	5	49
1931M-4.5	7314151049188	366	10	5	49
1931M-5	7314151049195	366	10	5	49
1931M-5.5	7314151049201	366	10	5	49
1931M-6	7314151049218	366	10	5	49
1931M-7	7314151049225	366	10	5	49
1931M-8	7314151049232	366	10	5	49
1931M-9	7314151049249	366	10	5	49
1931M/10T	7314151049409	366	10	5	51
1931Z-1/2	7314151049775	366	10	5	50
1931Z-1/4	7314151049713	366	10	5	50
1931Z-1/8	7314150371563	366	10	5	50
1931Z-11/32	7314151049744	366	10	5	50
1931Z-11/32-3/8	7314150371624	366	10	5	50
1931Z-13/64	7314151049683	366	10	5	50
1931Z-15/64-1/4	7314150371570	366	10	5	50
1931Z-3/16	7314151049676	366	10	5	50
1931Z-3/8	7314151049751	366	10	5	50
1931Z-5/16	7314151049737	366	10	5	50
1931Z-5/32	7314151049669	366	10	5	50
1931Z-5/8	7314151049799	366	10	5	50
1931Z-7/16	7314151049768	366	10	5	50



CUENTA SUBGRUPO



1931Z-7/32	7314151049690	366	10	5	50
1931Z-9/16	7314151049782	366	10	5	50
1931Z-9/32	7314151049720	366	10	5	50
1931Z-9/32-5/16	7314150371600	366	10	5	50
1931Z/12T	7314150107674	366	10	1	51
1933M/6T	7314151821654	366	10	1	51
1936M-10-11	7314151051402	366	15	25	59
1936M-10-13	7314151344146	366	15	25	59
1936M-12-13	7314151051419	366	15	25	59
1936M-13-17	7314151830144	366	15	20	59
1936M-14-15	7314151051426	366	15	5	59
1936M-14-17	7314151051129	366	15	15	59
1936M-16-17	7314151051433	366	15	15	59
1936M-17-19	7314151051136	366	15	10	59
1936M-18-19	7314151051440	366	15	10	59
1936M-19-22	7314151051150	366	15	8	59
1936M-20-22	7314151830151	366	15	8	59
1936M-21-23	7314151830168	366	15	8	59
1936M-22-24	7314151830175	366	15	5	59
1936M-24-26	7314151830182	366	15	5	59
1936M-24-27	7314151051181	366	15	5	59
1936M-25-28	7314151830199	366	15	5	59
1936M-30-32	7314151051501	366	15	1	59
1936M-30-34	7314151838577	366	15	4	59
1936M-36-41	7314151830205	366	15	4	59
1936M-46-50	7314151830212	366	15	2	59
1936M-6-7	7314151051389	366	15	50	59
1936M-8-10	7314151830137	366	15	30	59
1936M-8-9	7314151051396	366	15	5	59
1936M/12	7314151830250	366	15	1	59
1936M/7	7314151830243	366	15	1	59
1943M-11-13	7314151052829	366	10	1	54
1943M-13-15	7314151804732	366	10	1	54
1943M-13-17	7314151804749	366	10	1	54
1943M-14-16	7314151052836	366	10	1	54
1943M-14-17	7314151052843	366	10	1	54
1943M-15-17	7314151052850	366	10	1	54
1943M-19-22	7314151052867	366	10	1	54
1943Z-11/16-13/16	7314150355174	366	10	1	54
1943Z-5/16-3/8	7314150355136	366	10	1	54
1943Z-5/8-3/4	7314150355167	366	10	1	54
1943Z-7/16-1/2	7314150355143	366	10	1	54
1943Z-9/16-5/8	7314150355150	366	10	1	54
1949M-10-11	7314151055394	366	10	1	55
1949M-10-12	7314151055400	366	10	1	55
1949M-12-13	7314151055417	366	10	1	55
1949M-12-14	7314151055424	366	10	1	55
1949M-14-15	7314151304546	366	10	1	55
1949M-14-17	7314151055448	366	10	1	55
1949M-17-19	7314151055455	366	10	1	55
1949M-19-22	7314151055462	366	10	1	55
1949M-22-24	7314151304553	366	10	1	55
1949M-24-27	7314151055479	366	10	1	55
1949M-30-32	7314151304577	366	10	1	55
1949M-8-9	7314151304539	366	10	1	55
1949Z-1-1.1/8	7314151055547	366	10	1	55
1949Z-1/2-9/16	7314151055509	366	10	1	55
1949Z-3/4-7/8	7314151055530	366	10	1	55
1949Z-3/8-7/16	7314151055486	366	10	1	55
1949Z-5/8-3/4	7314151055523	366	10	1	55
1950M-2/3-8	7314150130207	310	15	1	55
1952M-10	7314151057213	366	10	10	44
1952M-11	7314151057220	366	10	10	44
1952M-12	7314151057237	366	10	10	44
1952M-13	7314151057244	366	10	10	44
1952M-14	7314151057251	366	10	10	44
1952M-15	7314151057268	366	10	10	44
1952M-16	7314151057275	366	10	10	44
1952M-17	7314151057282	366	10	10	44
1952M-18	7314151057299	366	10	10	44
1952M-19	7314151057305	366	10	10	44
1952M-20	7314151057312	366	10	10	44
1952M-21	7314151057329	366	10	10	44
1952M-22	7314151057336	366	10	5	44
1952M-23	7314151057343	366	10	5	44
1952M-24	7314151057350	366	10	5	44
1952M-25	7314151057367	366	10	5	44
1952M-26	7314151057374	366	10	5	44
1952M-27	7314151057381	366	10	5	44
1952M-28	7314151057398	366	10	1	44
1952M-29	7314151325763	366	10	1	44
1952M-30	7314151057404	366	10		



1952M/10	7314151057688	366	10	1	45
1952M/14T	7314151057695	366	10	1	45
1952M/17T	7314151057473	366	10	1	45
1952M/26T	7314151057701	366	10	1	45
1952M/7T	7314151806637	366	10	1	45
1952M/SH12	7314153013330	366	10	1	44
1952M/SH6	7314153013286	366	10	1	44
1952Z-1	7314151057602	366	10	1	44
1952Z-1.1/16	7314151057619	366	10	1	44
1952Z-1.1/2	7314151057756	366	10	1	44
1952Z-1.1/4	7314151057633	366	10	1	44
1952Z-1.1/8	7314151057626	366	10	1	44
1952Z-1.3/8	7314151057732	366	10	1	44
1952Z-1.5/16	7314151057718	366	10	1	44
1952Z-1.5/8	7314151057763	366	10	1	44
1952Z-1.7/16	7314151057749	366	10	1	44
1952Z-1/2	7314151057527	366	10	5	44
1952Z-1/4	7314151057480	366	10	5	44
1952Z-11/16	7314151057558	366	10	5	44
1952Z-11/32	7314150111046	366	10	5	44
1952Z-13/16	7314151057572	366	10	5	44
1952Z-15/16	7314151057596	366	10	5	44
1952Z-3/4	7314151057565	366	10	5	44
1952Z-3/8	7314151057503	366	10	5	44
1952Z-5/16	7314151057497	366	10	5	44
1952Z-5/8	7314151057541	366	10	5	44
1952Z-7/16	7314151057510	366	10	5	44
1952Z-7/8	7314151057589	366	10	5	44
1952Z-9/16	7314151057534	366	10	5	44
1952Z/11T	7314151057725	366	10	1	45
1976TORX-T10	7314150123438	350	54	5	206
1976TORX-T15	7314150123452	350	54	5	206
1976TORX-T20	7314150123469	350	54	5	206
1976TORX-T25	7314150123476	350	54	5	206
1976TORX-T27	7314150123490	350	54	5	206
1976TORX-T30	7314150123506	350	54	5	206
1976TORX-T40	7314150123513	350	54	5	206
1976TORX-T6	7314150122240	350	54	5	206
1976TORX-T7	7314150123384	350	54	5	206
1976TORX-T8	7314150123391	350	54	5	206
1976TORX-T9	7314150123414	350	54	5	206
1976TORX/5T	7314150126927	350	54	1	206
1986TORX-T10	7314150123537	350	54	5	205
1986TORX-T15	7314150123544	350	54	5	205
1986TORX-T20	7314150123551	350	54	5	205
1986TORX-T25	7314150123568	350	54	5	205
1986TORX-T27	7314150123575	350	54	5	205
1986TORX-T30	7314150123582	350	54	5	205
1986TORX-T40	7314150123599	350	54	5	205
1986TORX-T9	7314150122233	350	54	5	205
1986TORX/7T	7314150123735	350	54	1	206
1995LM-1.5	7314150122172	350	54	10	202
1995LM-10	7314150123254	350	54	10	203
1995LM-12	7314150123261	350	54	10	203
1995LM-14	7314150123278	350	54	10	203
1995LM-2	7314150122189	350	54	10	202
1995LM-2.5	7314150123162	350	54	10	203
1995LM-3	7314150123179	350	54	10	203
1995LM-4	7314150123186	350	54	10	203
1995LM-5	7314150123209	350	54	10	203
1995LM-6	7314150123216	350	54	10	203
1995LM-7	7314150123223	350	54	10	203
1995LM-8	7314150123230	350	54	10	203
1995LM-9	7314150123247	350	54	10	203
1995M-0.9	7314150216291	350	54	10	200
1995M-1.5	7314150122158	350	54	10	200
1995M-10	7314150122912	350	54	10	200
1995M-12	7314150122943	350	54	10	200
1995M-14	7314150122967	350	54	10	200
1995M-17	7314150122974	350	54	10	200
1995M-19	7314150122981	350	54	10	200
1995M-2	7314150122745	350	54	10	200
1995M-2.5	7314150122752	350	54	10	200
1995M-22	7314150122998	350	54	10	200
1995M-3	7314150122769	350	54	10	200
1995M-4	7314150122776	350	54	10	200
1995M-5	7314150122790	350	54	10	200
1995M-6	7314150122813	350	54	10	200
1995M-7	7314150122837	350	54	10	200
1995M-8	7314150122851	350	54	10	200
1995M-9	7314150122875	350	54	10	200
1995M/10T	7314150123643	350	54	1	202
1995M/11T	7314150123650	350	54	1	202
1995M/15T	7314150123667	350	54	1	202
1995M/6T	7314150123629	350	54	1	201
1995M/8T	7314150123636	350	54	1	201
1995TORX-T10	7314150123308	350	54	5	204
1995TORX-T15	7314150123322	350	54	5	204
1995TORX-T20	7314150123339	350	54	5	204
1995TORX-T25	7314150123346	350	54	5	204
1995TORX-T27	7314150123353	350	54	5	204
1995TORX-T30	7314150123360	350	54	5	204
1995TORX-T40	7314150123377	350	54	5	204
1995TORX-T45	7314150123407	350	54	5	204
1995TORX-T50	7314150123421	350	54	5	204
1995TORX-T55	7314150216963	350	54	5	204
1995TORX-T6	7314150122196	350	54	5	204
1995TORX-T60	7314150216970	350	54	5	204



1995TORX-T7	7314150123285	350	54	5	204
1995TORX-T8	7314150123292	350	54	5	204
1995TORX-T9	7314150122219	350	54	5	204
1995TORX/11T	7314150123742	350	54	1	206
1995TORX/13T	7314150123759	350	54	1	206
1995TORX/4T	7314150123674	350	54	1	206
1995TORX/7T	7314150123711	350	54	1	206
1995Z-1/16	7314150122165	350	54	10	203
1995Z-1/2	7314150123117	350	54	10	203
1995Z-1/4	7314150123070	350	54	10	203
1995Z-1/8	7314150123025	350	54	10	203
1995Z-3/16	7314150123056	350	54	10	203
1995Z-3/32	7314150123018	350	54	10	203
1995Z-3/4	7314150123155	350	54	10	203
1995Z-3/8	7314150123094	350	54	10	203
1995Z-5/16	7314150123087	350	54	10	203
1995Z-5/32	7314150123049	350	54	10	203
1995Z-5/64	7314150123001	350	54	10	203
1995Z-5/8	7314150123131	350	54	10	203
1995Z-7/16	7314150123100	350	54	10	203
1995Z-7/32	7314150123063	350	54	10	203
1995Z/10T	7314150215980	350	54	1	203
1995Z/12T	7314150215997	350	54	1	203
1996M-1.5	7314150122202	350	54	10	203
1996M-10	7314150122721	350	54	10	203
1996M-12	7314150122738	350	54	10	203
1996M-2	7314150122653	350	54	10	203
1996M-2.5	7314150122660	350	54	10	203
1996M-3	7314150122677	350	54	10	203
1996M-4	7314150122684	350	54	10	203
1996M-5	7314150122691	350	54	10	203
1996M-6	7314150122707	350	54	10	203
1996M-8	7314150122714	350	54	10	203
1996TORX-T10	7314150122783	350	54	5	205
1996TORX-T15	7314150122806	350	54	5	205
1996TORX-T20	7314150122820	350	54	5	205
1996TORX-T25	7314150122844	350	54	5	205
1996TORX-T27	7314150122868	350	54	5	205
1996TORX-T30	7314150122882	350	54	5	205
1996TORX-T40	7314150122899	350	54	5	205
1996TORX-T45	7314150122905	350	54	5	205
1996TORX-T50	7314150122929	350	54	5	205
1996TORX-T9	7314150122226	350	54	5	205
1996TORX/5T	7314150123698	350	54	1	205
1997M-10	7314151059354	350	54	10	200
1997M-11	7314151059361	350	54	10	200
1997M-12	7314151059378	350	54	5	200
1997M-14	7314151059385	350	54	5	200
1997M-16	7314151059392	350	54	1	200
1997M-17	7314151059408	350	54	1	200
1997M-19	7314151059415	350	54	1	200
1997M-3.5	7314151302078	350	54	10	200
1997M-4	7314151059293	350	54	10	200
1997M-4.5	7314151302085	350	54	10	200
1997M-5	7314151059309	350	54	10	200
1997M-6	7314151059316	350	54	10	200
1997M-7	7314151059323	350	54	10	200
1997M-8	7314151059330	350	54	10	200
1997M-9	7314151059347	350	54	10	200
1997M/10T	7314151302108	350	54	1	200
1997M/11T	7314151059453	350	54	1	200
1997M/7T	7314151059439	350	54	1	200
1998M-1.5	7314150185719	350	54	10	200
1998M-10	7314150185801	350	54	10	200
1998M-12	7314150185818	350	54	5	200
1998M-14	7314150185825	350	54	1	200
1998M-17	7314150185832	350	54	1	200
1998M-19	7314150185849	350	54	1	200
1998M-2	7314150185726	350	54	10	200
1998M-2.5	7314150185733	350	54	10	200
1998M-22	7314150185856	350	54	1	200
1998M-3	7314150185740	350	54	10	200
1998M-4	7314150185757	350	54	10	200
1998M-5	7314150185764	350	54	10	200
1998M-6	7314150185863	350	54	10	200
1998M-7	7314150185771	350	54	10	200
1998M-8	7314150185788	350	54	10	200
1998M-9	7314150185795	350	54	5	200
1998M/10T	7314150186228	350	54	1	201
1998M/11T	7314150186235	350	54	1	201
1998M/15T	7314150186242	350	54	1	201
1998M/6T	7314150186204	350	54	1	201
1998M/8R	7314150186266	350	54	1	201
1998M/8T	7314150186211	350	54	1	201
1999M/7H	7314151801076	350	54	1	201
1999MV-10	7314150121496	350	36	3	443
1999MV-12	7314150121502				

1RM-14



CUENTA SUBGRUPO



1RM-14	7314153000613	366	25	1	45
1RM-15	7314153000620	366	25	1	45
1RM-16	7314153000637	366	25	1	45
1RM-17	7314153000644	366	25	1	45
1RM-18	7314153000651	366	25	1	45
1RM-19	7314153000668	366	25	1	45
1RM-21	7314150214495	366	25	1	45
1RM-22	73141530005915	366	25	1	45
1RM-24	73141530005922	366	25	1	45
1RM-27	7314153014177	366	25	1	45
1RM-30	7314153014184	366	25	1	45
1RM-32	7314153014191	366	25	1	45
1RM-6	7314153014146	366	25	1	45
1RM-7	7314153014153	366	25	1	45
1RM-8	7314153000552	366	25	1	45
1RM-9	7314153000569	366	25	1	45
1RM/S5	7314150225514	366	25	10	47
1RM/SH12	7314150219780	366	25	10	46
1RM/SH6	7314150219773	366	25	1	46
1RM/SH8	7314150223015	366	25	1	46
1RMA-10-1/4-BIT	7314153014634	366	25	1	49
1RMA-10-1/4-SQ	7314153014603	366	25	1	49
1RMA-13-10-BIT	7314150223008	366	25	1	49
1RMA-13-3/8-SQ	7314153014610	366	25	1	49
1RMA-13-5/16-BIT	7314153014641	366	25	1	49
1RMA-19-1/2-SQ	7314153014627	366	25	1	49
1RMA-19-1/4-SQ	7314150190638	366	25	1	49
1RMA/S4	7314153014658	366	25	1	49
1RMA/S8	7314153014665	366	25	1	47
1RZ-1/2	7314153014245	366	25	1	46
1RZ-1/4	7314150153725	366	25	1	46
1RZ-11/16	7314153014269	366	25	1	46
1RZ-11/32	7314150358915	366	25	1	46
1RZ-15/16	7314150358939	366	25	1	46
1RZ-3/4	7314153014276	366	25	1	46
1RZ-3/8	7314153014214	366	25	1	46
1RZ-5/16	7314153014207	366	25	1	46
1RZ-5/8	7314153014252	366	25	1	46
1RZ-7/16	7314153014221	366	25	1	46
1RZ-7/8	7314150358922	366	25	1	46
1RZ-9/16	7314153014238	366	25	1	46
1RZ/SH8	7314150223022	366	25	1	47
1Z-1	7314150375189	366	10	10	41
1Z-1/2	7314150375103	366	10	10	41
1Z-1/4	7314150375042	366	10	20	41
1Z-11/16	7314150375134	366	10	10	41
1Z-11/32	7314150375073	366	10	10	41
1Z-13/16	7314150375158	366	10	10	41
1Z-15/16	7314150375172	366	10	5	41
1Z-3/16	7314150375028	366	10	20	41
1Z-3/4	7314150375141	366	10	10	41
1Z-3/8	7314150375080	366	10	10	41
1Z-5/16	7314150375066	366	10	10	41
1Z-5/8	7314150375127	366	10	10	41
1Z-7/16	7314150375097	366	10	10	41
1Z-7/32	7314150375035	366	10	20	41
1Z-7/8	7314150375165	366	10	10	41
1Z-9/16	7314150375110	366	10	10	41
1Z-9/32	7314150375059	366	10	20	41
2-21-51	7315962500011	316	10	5	567
2-300-14-0-0	7311518044138	324	30	10	26
2-300-14-2-0	7311518044145	324	30	10	26
2-300-14-4-0	7311518108786	324	30	10	26
2-300-14-D-1P	7311518189105	324	35	10	29
2-300-16-0-0	7311518020491	324	30	10	26
2-300-16-1-0	7311518020507	324	30	10	26
2-300-16-2-0	7311518020514	324	30	10	26
2-300-16-4-0	7311518020521	324	30	10	26
2-300-16-D-1P	7311518189129	324	35	10	29
2-300-18-0-0	7311518190545	324	30	10	26
2-300-18-2-0	7311518190552	324	30	10	26
2-301-14-0-0	7311518190569	324	30	10	26
2-301-14-2-0	7311518108748	324	30	10	26
2-301-14-D-1P	7311518189136	324	35	1	29
2-301-16-0-0	7311518108755	324	30	10	26
2-301-16-1-0	7311518020538	324	30	10	26
2-301-16-2-0	7311518020545	324	30	10	26
2-302-14-0-0	7311518044152	324	30	10	26
2-302-14-2-0	7311518044169	324	30	10	26
2-302-14-4-0	7311518108793	324	30	10	26
2-302-14-D-1P	7311518189150	324	35	10	29
2-302-16-0-0	7311518108762	324	30	10	26
2-302-16-1-0	7311518020552	324	30	10	26
2-302-16-2-0	7311518020569	324	30	10	26
2-302-16-4-0	7311518108809	324	30	10	26
2-302-16-D-1P	7311518189167	324	35	10	29
2-302-18-0-0	7311518190613	324	30	10	26
2-302-18-2-0	7311518190620	324	30	10	26
2-303-14-2-0	7311518044176	324	30	10	26
2-303-14-D-1P	7311518189174	324	35	10	29
2-303-16-0-0	7311518108779	324	30	10	26
2-303-16-1-0	7311518020576	324	30	10	26
2-303-16-2-0	7311518020583	324	30	10	26
2-303-16-4-0	7311518108830	324	30	10	26
2-303-16-D-1P	7311518189198	324	35	1	29
2-303-18-0-0	7311518190644	324	30	10	26
2-303-18-2-0	7311518190668	324	30	10	26
2-304-14-0-0	7311518044183	324	30	10	26



CUENTA SUBGRUPO



2-304-14-2-0	7311518044190	324	30	10	26
2-304-14-4-0	7311518108878	324	30	10	26
2-304-14-D-1P	7311518189204	324	35	10	29
2-304-16-0-0	7311518020590	324	30	10	26
2-304-16-1-0	7311518020606	324	30	10	26
2-304-16-2-0	7311518020613	324	30	10	26
2-304-16-4-0	7311518020620	324	30	10	26
2-304-16-D-1P	7311518189211	324	35	10	29
2-304-18-0-0	7311518190712	324	30	10	26
2-304-18-2-0	7311518190736	324	30	10	26
2-305-16-1-0	7311518020637	324	30	10	26
2-305-16-2-0	7311518108908	324	30	10	26
2-306-14-D-1P	7311518189228	324	35	1	29
2-306-16-1-0	7311518020644	324	30	10	26
2-306-16-2-0	7311518108854	324	30	10	26
2-307-14-0-0	7311518044206	324	30	10	27
2-307-14-2-0	7311518044213	324	30	10	27
2-307-14-4-0	7311518108885	324	30	10	27
2-307-14-D-1P	7311518189235	324	35	10	29
2-307-16-0-0	7311518020651	324	30	10	27
2-307-16-1-0	7311518020668	324	30	10	27
2-307-16-2-0	7311518020675	324	30	10	27
2-307-16-4-0	7311518020682	324	30	10	27
2-307-16-D-1P	7311518189242	324	35	10	29
2-307-18-0-0	7311518190965	324	30	10	27
2-307-18-2-0	7311518190972	324	30	10	27
2-308-14-2-0	7311518044220	324	30	10	27
2-308-14-D-1P	7311518189259	324	35	1	29
2-308-16-0-0	7311518108861	324	30	10	27
2-308-16-1-0	7311518020699	324	30	10	27
2-308-16-2-0	7311518020705	324	30	10	27
2-309-16-2-0	7311518108946	324	30	10	27
2-309-16-4-0	7311518191054	324	30	10	27
2-313-16-0-0	7311518191177	324	30	10	26
2-470-14-0-0	7311518191191	324	30	10	27
2-470-14-2-0	7311518109080	324	30	10	27
2-470-14-4-0	7311518191207	324	30	10	27
2-470-16-1-0	7311518010942	324	30	10	27
2-470-16-2-0	7311518109097	324	30	10	28
2-471-16-1-0	7311518010959	324	30	5	28
2-472-14-0-0	7311518191214	324	30	5	28
2-472-14-2-0	7311518109103	324	30	5	28
2-472-16-0-0	7311518191238	324	30	5	28
2-472-16-1-0	7311518010966	324	30	5	28
2-472-16-2-0	7311518108922	324	30	5	29
2010	7314151584610	356	15	1	415
204030150	8413345400855	362	20	12	493
204030160	8413345400862	362	20	12	493
204030180	8413345400879	362	20	12	493
204050130	8413345097970	362	20	6	493
204530140	8413345097918	362	20	12	493
204550130	8413345097956	362	20	6	493
2045A3000	8413345097932	362	20	12	493
2047-0-8-4	7314151060459	350	54	5	207
2047-1-5-5	7314151060473	350	54	5	207
2047-1-2-8	7314151060480	350	54	5	207
2047-1-6-10	7314151060497	350	54	1	207
2047-2-12	7314151060503	350	54	1	207
2047PR-1-2	7314151060558	350	54	5	207
2047PR-3-4	7314151060565	350	54	5	207
2047PZ-1-2	7314150216390	350	54	5	207
2058/S26	7314151849276	354	25	30	166
2058/S26-2	7314151849283	354	25	1	166
208	7311518017545	328	10	5	499
209027040	8413345400947	362	20	12	493
209227060	8413345400961	362	20	12	493
209228100	8413345099233	362	20	12	493
209250100	8413345099585	362	20	6	493
210	7315965100379	328	30	10	498
2100PD-150	7314150205691	340	65	5	212
2101D-125	7314150106387	340	65	5	210
2101D-125IP	7314150106431	340	65	5	210
2101D-140	7314150106394	340	65	5	210
2101D-140IP	7314150106325	340	65	5	210
2101D-160	7314150106400	340	65	5	210
2101D-160IP	7314150106318	340	65	5	210
2101D-180	7314150106417	340	65	5	210
2101D-180IP	7314150106448	340	65	5	210
2101G-125	7314150106462	340	65	5	210
2101G-125IP	7314150106516	340	65	5	210
2101G-125IPD	7314150335039	340	65	5	210
2101G-140	7314150106479	340	65		



CUENTA SUBGRUPO



2101S-200	7314150106622	340	90	3	440
211035180	8413345000147	362	20	5	493
211042210	8413345000154	362	20	5	493
212027180	8413345000178	362	20	5	494
212033220	8413345129435	362	20	8	494
212202500	8413345110266	362	20	10	494
212302900	8413345110280	362	20	10	494
212502150	8413345110303	362	20	10	494
212602150	8413345110327	362	20	10	494
212602800	8413345129404	362	20	10	494
212704350	8413345122184	362	15	6	494
213026140	8413345000185	362	20	5	494
2145020D0	8413345097994	362	15	1	494
2145020L0	8413345098045	362	15	1	494
2145025C0	8413345098083	362	15	1	494
2145025D0	8413345098007	362	15	1	494
2145025L0	8413345098052	362	15	1	494
2145030D0	8413345098014	362	15	1	494
2145030L0	8413345098069	362	15	1	494
2145035D0	8413345098021	362	15	1	494
2145035L0	8413345098076	362	15	1	494
2145039C0	8413345098090	362	15	1	494
2145PD-150	7314150114009	340	65	5	214
215-150	7311518017576	328	20	1	499
215000030	8413345131971	362	10	12	491
215000040	8413345131988	362	10	12	491
215000050	8413345131995	362	10	12	491
215000060	8412243557944	362	10	12	491
215000070	8413345132008	362	10	12	491
215000080	8413345132015	362	10	12	491
215000090	8413345132022	362	10	12	491
215000100	8413345132039	362	10	12	491
215000120	8413345132046	362	10	12	491
215500300	7314150220120	362	10	12	490
215500400	8413345122627	362	10	12	490
215500500	8413345122641	362	10	12	490
215500600	8413345122665	362	10	12	491
215500700	8413345122689	362	10	12	491
215500800	8413345122702	362	10	12	491
215500900	8413345137478	362	10	12	491
215501000	8413345122726	362	10	12	491
216-150-R	7311518017583	328	20	1	499
216-300-R	7311518017798	328	20	1	499
216000300	8413345403658	362	10	12	491
216000400	8413345403665	362	10	12	491
216000500	8413345403672	362	10	12	491
216000600	8413345403689	362	10	12	491
216000700	8413345403696	362	10	12	491
216000800	8413345403702	362	10	12	491
216000900	8413345403719	362	10	12	491
216001000	8413345403726	362	10	12	491
216001200	8413345403740	362	10	12	491
216100040	8413345132053	362	10	12	491
216100060	8413345132091	362	10	12	491
216100080	8413345132060	362	10	12	491
216100100	8413345132077	362	10	12	491
216100120	8413345132084	362	10	12	491
216500300	8413345407274	362	10	12	491
216500500	8413345407281	362	10	12	491
216500750	8413345407298	362	10	12	491
216501000	8413345407304	362	10	12	491
2171G-140	7314150116232	340	65	5	212
2171G-160	7314150116133	340	65	5	212
2171G-180	7314150116140	340	65	5	212
2171V-160	7314150126798	340	90	2	440
2171V-180	7314150126804	340	90	2	440
218	7311518017521	328	20	10	499
218-BULK	7311518140946	328	20	1	499
219	7311518140953	328	20	5	499
219001000	8413345029865	362	10	5	491
219001200	8413345029872	362	10	5	491
219001400	8413345029889	362	10	5	491
219001600	8413345029896	362	10	5	491
219002000	8413345029902	362	10	5	491
2190PD-150	7314150114016	340	65	5	212
2191V-180	7314150128716	340	90	2	440
2191V-200	7314150128723	340	90	2	440
219201000	8413345029667	362	10	5	491
219201200	8413345029674	362	10	5	491
219201400	8413345029681	362	10	5	491
219201600	8413345029698	362	10	5	491
219202000	8413345029704	362	10	5	491
219302500	8413345129466	362	10	10	491
219303000	8413345129473	362	10	10	491
219303500	8413345129480	362	10	10	491
21HDD-140	7314150231256	340	65	5	211
21HDD-140IP	7314150231263	340	65	5	211
21HDD-160	7314150231270	340	65	5	211
21HDD-160IP	7314150231287	340	65	5	211
21HDD-180	7314150231294	340	65	5	211
21HDD-180IP	7314150231300	340	65	5	211
21HDD-200	7314150231317	340	65	5	211
21HDD-200IP	7314150231324	340	65	5	211
21HDG-140	7314150231331	340	65	5	210
21HDG-140A	7314150237654	340	65	5	211
21HDG-140IP	7314150231348	340	65	5	210
21HDG-160	7314150231355	340	65	5	210
21HDG-160A	7314150237661	340	65	5	211



CUENTA SUBGRUPO



21HDG-160IP	7314150231362	340	65	5	210
21HDG-180	7314150231379	340	65	5	210
21HDG-180A	7314150237678	340	65	5	211
21HDG-180IP	7314150231386	340	65	5	210
21HDG-200	7314150231409	340	65	5	210
21HDG-200A	7314150238439	340	65	5	211
21HDG-200IP	7314150231416	340	65	5	210
21HDGC-140IP	7314150231423	340	65	5	211
21HDGC-160IP	7314150231430	340	65	5	211
21HDGC-180IP	7314150231447	340	65	5	211
21HDGC-200IP	7314150231454	340	65	5	211
221 D	7314150037070	340	75	5	226
221201200	8413345029711	362	10	5	491
221202000	8413345029728	362	10	5	491
221203000	8413345029735	362	10	5	491
221301200	8413345029742	362	10	5	491
221302000	8413345029759	362	10	5	491
221303000	8413345029766	362	10	5	491
222 D	7314150037087	340	75	5	226
22209004B	8413345401333	362	10	1	319
2223 D-150	7314150033591	340	25	5	229
2223 G-150	7314150113651	340	25	5	229
2223 S-150	7314150032983	340	90	5	442
2223GC-150	7314150123919	340	25	5	229
2223V-160	7314150134113	340	90	2	442
223 D	7314150037094	340	75	5	226
2233 D-160	7314150114023	340	25	5	216
2233 D-200	7314150114030	340	25	5	216
2233 D-240	7314150114047	340	25	5	216
2233D-160IP	7314150114054	340	25	5	216
2233D-200IP	7314150114061	340	25	5	216
2233D-240IP	7314150114078	340	25	5	216
2235-160	7314150179695	340	20	1	216
224 D	7314150037100	340	75	5	226
225 D	7314150037117	340	75	5	226
225-PLUS	7311518029708	328	10	5	498
2250V-170	7314150128730	340	90	2	441
2250V-230	7314150128747	340	90	2	441
2260 G-210	7314150205684	340	20	5	216
2260 S-210	7314150206759	340	90	2	440
2260V-210	7314150128754	340	90	2	441
227-22	7314150419845	360	15	1	128
227-24	7314150419852	360	15	1	128
227-27	7314150419869	360	15	1	128
227-30	7314150419876	360	15	1	128
227-32	7314150419883	360	15	1	128
227-34	7314150419890	360	15	1	128
227-36	7314150419906	360	15	1	128
227-41	7314150419913	360	15	1	128
227-46	7314150419920	360	15	1	128
228	7311518014995	328	20	5	499
228-15-5P	7311518031442	328	20	10	499
228-22	7314150420070	360	15	1	128
228-24	7314150420087	360	15	1	128
228-27	7314150420094	360	15	1	128
228-30	7314150420100	360	15	1	128
228-32	7314150420117	360	15	1	128
228-32-100P	7311518150990	328	20	1	499
228-32-10P	7311518010867	328	20	10	499
228-32-5P	7311518031459	328	20	10	499
228-34	7314150420124	360	15	1	128
228-36	7314150420131	360	15	1	128
228-41	7314150420148	360	15	1	128
228-46	7314150420155	360	15	1	128
228-BULK	7311518009069	328	20	5	499
228-SD	7311518277048	346	20	24	152
228-SET-SD	7314150217946	346	20	1	153
229-SD	7311518277055	346	20	24	153
22F-3/4	7314150419821	360	15	1	127
23-15	7314150419838	360	15	1	127
23-15	7311518274665	316	15	10	568
23-21	7311518012274	316	15	10	568
23-24	7311518003852	316	15	10	568
23-30	7311518003869	316	15	10	568
23-32	7311518003876	316	15	10	568
23-36	7311518003883	316	15	10	568
230-SD	7311518280956	346	20	25	153
2301A0000	8413345091282	362	20	6	494
2301B0000	8413345091305	362	20	6	494
2301C0000	8413345091329	362	20	6	494
2302A0000	8413345091343	362	20	6	495
2302B0000	8413345091367	362	20	6	495
2302C0000	8413345091381	362	20	6	495
2303B0000	8413345091404	362	20	6	

233-300-A



CUENTA	SUBGRUPO				
233-300-A	7311518044039	330	15	5	506
233-400	7311518044022	330	15	5	506
2339 D	7314150032792	340	45	3	214
2339 DIP	7314150103508	340	45	5	214
2339-220IP	7314150101061	340	45	5	215
2339-250IP	7314150101078	340	45	5	215
2339-280IP	7314150101948	340	45	5	215
2339-300IP	7314150123865	340	45	5	215
2339D-300	7314150411245	340	45	5	214
2339D-300IP	7314150411238	340	45	6	214
234-A1	7311518013653	330	15	1	506
234-A2	7311518013660	330	15	1	506
234-SD	7314150214846	346	20	25	153
234-W1	7311518013608	330	15	10	506
234-W2	7311518013615	330	15	10	506
234-W3	7311518013622	330	15	10	506
236001200	8413345129077	362	20	6	495
236101200	8413345129060	362	20	6	495
238	7311518011314	328	20	5	499
239	7311518010874	328	20	5	498
2420 G-125	7314150102525	340	55	5	222
2421 D-140IP	7314150101979	340	55	5	223
2421 D-160	7314150032594	340	55	5	223
2421 D-160IP	7314150101986	340	55	5	223
2421 D-180IP	7314150101993	340	55	5	223
2421 G-140	7314150102532	340	55	5	222
2421 G-140IP	7314150102006	340	55	5	222
2421 G-160	7314150102549	340	55	5	222
2421 G-160 IP	7314150100576	340	55	5	222
2421 G-180	7314150102556	340	55	5	222
2421 G-180 IP	7314150100583	340	55	5	222
2421GC-160	7314150123902	340	55	5	222
2421GC-180IP	7314150233229	340	55	5	222
2421V-160	7314150126774	340	90	2	442
2427 D-160	7314150032846	340	55	5	221
2427 D-200	7314150169030	340	55	5	221
2427 G-160	7314150100408	340	55	5	221
2427 G-160 IP	7314150100743	340	55	5	221
2427 G-200	7314150100415	340	55	5	221
2427 G-200 IP	7314150100750	340	55	5	221
2427 GC-160IP	7314150102051	340	55	5	221
2427 GC-200IP	7314150102075	340	55	5	221
2427 S-200	7314150033027	340	90	3	441
2427V-200	7314150126903	340	90	2	442
2430 D-140	7314150032853	340	55	5	219
2430 D-140 IP	7314150100774	340	55	5	219
2430 D-160	7314150032860	340	55	5	219
2430 D-160 IP	7314150100781	340	55	5	219
2430 D-200	7314150032884	340	55	5	219
2430 D-200 IP	7314150100804	340	55	5	219
2430 G-140	7314150102563	340	55	5	219
2430 G-140 IP	7314150102143	340	55	5	219
2430 G-160	7314150024070	340	55	5	219
2430 G-160 IP	7314150100811	340	55	5	219
2430 G-190HD	7311518259945	340	55	5	219
2430 G-200	7314150100422	340	55	5	219
2430 G-200 IP	7314150100835	340	55	5	219
2430 GC-140 IP	7314150102150	340	55	5	219
2430 GC-160 IP	7314150102167	340	55	5	219
2430 GC-200 IP	7314150102174	340	55	5	219
2430 S-160	7314150206742	340	90	3	441
2430 S-200	7314150033010	340	90	3	441
2430V-160	7314150126880	340	90	2	442
2430V-200	7314150126897	340	90	2	442
244-20-U7/8-HP	7311518012519	330	10	10	504
244-22-U7/8-HP	7311518012526	330	10	10	504
2444	7311518286750	334	10	15	523
2444-LAP	7314150237463	334	10	10	523
2446	7314150128648	334	10	15	523
2446-EL	7314150270736	334	10	12	522
2446-EL-HELP	7314150039450	334	10	12	522
2446-ELL	7314150370153	334	10	12	522
2446-ELR	7314150370146	334	10	12	522
2446-LINO	7314150270750	334	10	12	523
2446-OV	7314150313662	334	10	15	523
2448	7314150136049	334	10	12	513
2449	7314150194056	334	10	12	513
244P-20-U7-HP	7311518235499	330	10	4	505
244P-22-U7-HP	7311518235482	330	10	10	505
2460	7314151063467	340	30	1	227
2461 C19	7314151063498	340	30	1	228
2461 C40	7314151063504	340	30	1	227
2461 C8	7314151063481	340	30	1	227
2463 D19	7314151063511	340	30	1	227
2463 D40	7314151063528	340	30	1	227
2463 D8	7314151588878	340	30	1	227
2464 A10	7314151063535	340	30	1	228
2464 A19	7314151063542	340	30	1	228
2464 A3	7314151406516	340	30	1	228
2464 A40	7314151063559	340	30	1	228
2465D-200	7314150120826	340	30	1	229
2466 B10	7314151063573	340	30	1	228
2466 B19	7314151063580	340	30	1	228
2466 B3	7314151406868	340	30	1	228
2466 B40	7314151063597	340	30	1	228
247-24	7314150367078	360	15	1	126
247-27	7314150367085	360	15	1	126
247-30	7314150367092	360	15	1	126



CUENTA	SUBGRUPO				
247-32	7314150367108	360	15	1	126
247-34	7314150367115	360	15	1	126
247-36	7314150367122	360	15	1	126
247-41	7314150367139	360	15	1	126
247-46	7314150367146	360	15	1	126
247-50	7314150367153	360	15	1	126
247-55	7314150367160	360	15	1	126
247-60	7314150367177	360	15	1	126
2470 G-160	7314150116188	340	55	5	220
2470 G-200	7314150116195	340	55	5	220
2471 G-160	7314150116225	340	55	5	223
2477 G-200	7314150116201	340	55	5	222
248-24	7314150367818	360	15	1	126
248-27	7314150367825	360	15	1	126
248-30	7314150367832	360	15	1	126
248-32	7314150367849	360	15	1	126
248-34	7314150367856	360	15	1	126
248-36	7314150367863	360	15	1	126
248-41	7314150367870	360	15	1	126
248-46	7314150367887	360	15	1	126
248-50	7314150367894	360	15	1	126
248-55	7314150367900	360	15	1	126
248-60	7314150367917	360	15	1	126
2484-20	7314150233250	322	25	1	343
2484-30	7314150233267	322	25	1	343
2484-45	7314150233274	322	25	1	343
2484-60	7314150233281	322	25	1	343
2484/S4	7311518276553	322	25	10	343
2485	7314150242382	312	20	1	318
2487	7311518276058	312	30	12	480
2488	7311518276072	334	10	12	490
2489	7311518276065	334	10	12	490
24A-14	7314150368235	360	15	1	124
24A-27	7314150368242	360	15	1	124
24F-1	7314150366231	360	15	1	125
24F-3/4	7314150366224	360	15	1	125
24R-1	7314150365951	360	15	1	124
24R-3/4	7314150365944	360	15	1	124
24T-1	7314150366156	360	15	1	124
24T-3/4	7314150366149	360	15	1	124
24W	7314150368266	360	15	1	124
2500-16-XT-HP	7311518160159	330	10	4	504
2500-19-XT-HP	7311518160722	330	10	4	504
2500-22-XT-HP	7311518140922	330	10	4	504
2500-24-XT7-HP	7311518181338	330	10	4	504
250400000	8413345129374	362	15	1	492
250400010	7314150314430	362	15	1	492
250501800	8413345128964	362	15	50	492
250502450	8413345128957	362	15	50	492
250703000	8413345129008	362	15	25	492
2509	7314151064280	322	10	50	480
2510	7314151064297	312	30	1	332
2520	7314150023752	340	20	1	216
2520 S	7314150033041	340	90	1	440
2520-SH	7311518197506	340	20	1	216
2521 D-140	7314150032907	340	55	5	224
2521 G-140	7314150100293	340	55	5	224
2521 G-160 IP	7314150100620	340	55	5	224
2521D-160	7314150127139	340	55	5	224
2521GC-160	7314150127146	340	55	5	224
2521V-160	7314150126781	340	90	2	442
2530	7314150326761	322	10	1	480
2530-40	7314151317294	340	80	5	480
2535F0	7314150402236	322	10	1	313
2535F1	7314151064495	322	10	1	313
2535F2	7314150233854	322	10	1	313
2535F3	7314150180233	322	10	1	313
255-17/34	7314150272372	330	10	2	503
255-34	7314150272365	330	10	2	503
2555	7311518276041	312	10	1	284
256-26	7311518000080	330	10	4	503
2600-16-XT11-HP	7311518239527	330	10	4	504
2600-19-XT-HP	7311518160760	330	10	4	504
2600-22-XT-HP	7311518160777	330	10	4	504
2620-80	7311518200947	340	20	1	216
2628 D-160	7314150123193	340	35	5	218
2628 D-180	7314150042661	340	35	5	218
2628 D-200	7314150123315	340	35	5	218
2628 G-160	7314150042999	340	35	5	217
2628 G-160IP	7314150055357	340	35	5	217
2628 G-180	7314150042678	340	35	5	217
2628 G-180IP	7314150044030	340	35	5	217
2628 G-200	7314150103539	340	35	5	217
2628 GC-160IP	7314150101863	340	35	5	218
2628 GC-180IP	7314150101870	340	35	5	218
2628 GC-200IP	7314150101887	340	35	5	218
2628 S-160	7314150206735	340	90	3	441
2628 S-180	7314150044054	340	90	3	441
2628 S-20					



CUENTA SUBGRUPO



2633HD/S6	7314150205783	312	30	1	278
2633HD1	7314150230464	312	30	1	278
2633HD2	7314150230471	312	30	1	278
2633HD3	7314150230488	312	30	1	278
2633HD4	7314150230495	312	30	1	278
2633HD5	7314150230501	312	30	1	278
2633HD6	7314150230518	312	30	1	278
2633L/S4	7311518276959	322	30	12	479
2635	7311518276348	338	20	1	547
2640D-160	7314150123766	340	35	10	218
2640D-180	7314150123773	340	35	5	218
2640D-200	7314150123797	340	35	5	218
2646	7314151304638	340	10	1	213
2646 A	7314151304645	340	10	1	213
2646 AK	7314151396619	340	10	1	213
2646 K	7314151495862	340	10	1	213
2646 M	7314151487928	340	10	1	213
2646 MF	7314151573683	340	10	1	223
2646 MS	7314151573768	340	10	1	225
2646 R	7314151304706	340	10	1	213
2646 RA	7314151834838	340	10	1	213
2646 RK	7314151496678	340	10	1	213
2648	7314151304713	340	10	1	213
2648 A	7314151304720	340	10	1	213
2649	7314150058013	340	10	1	213
2650	7314151065829	340	75	1	226
2650 B	7314151065843	340	75	1	226
2656	7314151304737	340	10	1	215
2656 R	7314151473976	340	10	1	222
2656 S	7314150058044	340	10	1	220
2666	7314150058006	340	10	1	213
2666 FK	7314151066079	340	10	1	213
2674 NB	7314151066321	340	65	1	213
2674 NVDE	7314151498535	340	90	1	441
2676 B	7314151066390	340	65	1	213
2678 B	7314151066468	340	65	1	213
2678 G-160	7314150116157	340	35	5	219
2678 G-180	7314150116164	340	35	5	219
2678 G-200	7314150116171	340	35	5	219
2678V-160	7314150126835	340	90	2	441
2678V-180	7314150126842	340	90	2	441
2678V-200	7314150126859	340	90	2	441
268	7311518017538	328	20	5	498
2681	7311518276706	340	93	12	239
2681-1	7314150116980	340	93	1	240
2686	7314151066598	340	50	1	215
2688D-250	7314150123520	340	35	3	218
2690	7314150411108	340	94	10	240
26S-1216	7314151830236	366	30	8	60
26S-16	7314150345588	366	30	5	60
26S-610	7314151830229	366	30	10	60
2700-22-XT7-HP	7311518191672	330	10	4	505
2700-24-XT7-HP	7311518191665	330	10	4	505
2704A	7314151066963	340	70	1	519
2705R	7314151821470	312	30	1	519
2720	7314150179701	340	20	1	216
2720-SH	7314150179718	340	20	1	216
2744	7314151809096	340	70	6	518
277-30	7314150367184	360	15	1	126
277-32	7314150367191	360	15	1	126
277-34	7314150367207	360	15	1	126
277-36	7314150367214	360	15	1	126
277-41	7314150367221	360	15	1	126
277-46	7314150367238	360	15	1	126
277-50	7314150367245	360	15	1	126
277-55	7314150367252	360	15	1	126
277-60	7314150367269	360	15	1	126
278-30	7314150367924	360	15	1	126
278-32	7314150367931	360	15	1	126
278-34	7314150367948	360	15	1	126
278-36	7314150367955	360	15	1	126
278-41	7314150367962	360	15	1	127
278-46	7314150367979	360	15	1	127
278-50	7314150367986	360	15	1	127
278-55	7314150367993	360	15	1	127
278-60	7314150368006	360	15	1	127
2784-2.5	7314150215607	350	40	1	191
2784-3.5	7314150215614	350	40	1	191
2784-4.5	7314150215621	350	40	1	191
2787 F	7314151474270	340	10	1	214
2787 G	7314150058020	340	10	1	214
27A-24	7314150368259	360	15	1	124
27F-1	7314150366248	360	15	1	125
27M-10-11	7314150180523	366	15	10	59
27M-12-13	7314150180547	366	15	10	59
27M-13-17	7314150180790	366	15	10	59
27M-14-15	7314150180554	366	15	10	59
27M-16-17	7314150180561	366	15	10	59
27M-16-18	7314150180806	366	15	10	59
27M-18-19	7314150180578	366	15	10	59
27M-20-22	7314150180585	366	15	10	59
27M-21-23	7314150180592	366	15	5	59
27M-21-24	7314150180813	366	15	5	59
27M-24-26	7314150180608	366	15	5	59
27M-24-27	7314150180820	366	15	5	59
27M-25-28	7314150180622	366	15	5	59
27M-27-29	7314150180639	366	15	5	59
27M-30-32	7314150180646	366	15	5	59



CUENTA SUBGRUPO



27M-6-7	7314150180509	366	15	10	59
27M-8-9	7314150180516	366	15	10	59
27M/10	7314150180677	366	15	1	60
27M/12	7314150180684	366	15	1	60
27M/12T	7314150180783	366	15	1	59
27M/6	7314150180653	366	15	1	59
27M/8	7314150180660	366	15	1	60
27M/8T	7314150180776	366	15	1	59
27R-1	7314150365968	360	15	1	124
27T-1	7314150366163	360	15	1	124
28-29/S4	7314150179688	340	30	1	229
2800 N	7314151318338	340	20	1	217
2800-140	7314150121632	340	30	3	227
2800-150	7314150034567	340	30	3	227
2800-180	7314150034581	340	30	3	227
2800-225	7314150034604	340	30	3	227
2800-300	7314150122622	340	30	1	227
2801 N	7314151318352	340	20	1	217
2804	7314151692698	340	20	1	217
2805-280	7314151826123	340	20	1	217
2820EF1	7314150122042	334	10	12	522
2820EF2	7314150122059	334	10	12	522
2820EF3	7314150122066	334	10	1	522
2820EF4	7314150122073	334	10	1	522
2820EK	7314150122035	334	10	6	522
2820EK-01	7314150270743	334	10	12	523
2820V13	7314150121823	366	35	1	443
2820V17	7314150121830	366	35	1	443
2820VBC	7314150121915	340	90	1	441
2820VDE	7314151605476	334	45	10	444
2820VFP	7314150121922	348	40	1	444
2820VGO5	7314150121953	348	40	1	445
2820VG10	7314150121960	348	40	1	445
2820VGCOT	7314150121977	348	20	1	445
2820VHELP	7314150121908	334	45	1	444
2820VM	7314150121946	348	40	1	445
2820VP	7314150121885	334	45	2	444
2820VPC	7314150121892	334	45	2	444
2820VTEE	7314150121939	340	90	1	444
2855	7314151825805	340	93	1	241
2855 D	7314151822569	340	93	1	241
2890-125	7314150122639	340	30	3	227
2890-140	7314150034550	340	30	3	227
2890-180	7314150034574	340	30	3	227
2890-210	7314150034598	340	30	3	227
2890-300	7314150122646	340	30	1	227
28M-10	7314151834678	366	15	5	57
28M-11	7314151834685	366	15	5	57
28M-12	7314151834692	366	15	5	57
28M-13	7314151834708	366	15	5	57
28M-14	7314151834715	366	15	5	57
28M-15	7314151834722	366	15	5	57
28M-16	7314151834739	366	15	5	57
28M-17	7314151834746	366	15	5	57
28M-18	7314151834753	366	15	3	57
28M-19	7314151834760	366	15	3	57
28M-20	7314150122561	366	15	3	57
28M-21	7314151834777	366	15	3	57
28M-22	7314151834784	366	15	3	57
28M-23	7314150122578	366	15	3	57
28M-24	7314151834791	366	15	3	57
28M-25	7314150122585	366	15	3	57
28M-26	7314150122592	366	15	3	57
28M-27	7314151834807	366	15	3	57
28M-28	7314150122608	366	15	1	57
28M-29	7314150122615	366	15	1	57
28M-30	7314151834814	366	15	1	57
28M-32	7314151834821	366	15	1	57
28M-6	7314151834630	366	15	5	57
28M-7	7314151834647	366	15	5	57
28M-8	7314151834654	366	15	5	57
28M-9	7314151834661	366	15	5	57
28M/11	7314151838126	366	15	1	58
28M/12	7314151838133	366	15	1	58
28M/15	7314151838140	366	15	1	58
28M/8	7314151838119	366	15	1	58
28MV-10	7314150121298	366	35	2	443
28MV-11	7314150121304	366	35	2	443
28MV-12	7314150121311	366	35	2	443
28MV-13	7314150121328	366	35	2	443
28MV-14	7314150121335	366	35	2	443
28MV-15	7314150121342	366	35	2	443
28MV-16	7314150121359	366	35	2	443
28MV-17	7314150121366	366	35	2	443
28MV-18	7314150121373	366	35	2	443
28MV-19	7314150121380	366	35	2	443
28MV-20	7314150121397	366	35	2	443
28MV-21	7314150121403	366	35	2	443
28MV-22	7314150121410	366	35	2	443
28MV-8	7314150121274	366	35	2	443
28MV-9	7314150121281	366	35	2	443



CUENTA SUBGRUPO



2928-160	7314150056514	340	30	1	228
2928-2	7314150056590	340	30	1	228
2928-200	7314150056521	340	30	1	228
2928-250	7314150056538	340	30	1	228
2928-3	7314150056606	340	30	1	228
2928-4	7314150056613	340	30	1	228
2949-190IP	7314150123926	340	93	1	239
2949-200IP	7314150123940	340	93	1	239
2949-240IP	7314150123957	340	93	1	239
2949-250IP	7314150123971	340	93	1	239
2950-250	7314150124039	340	60	1	237
2951-140	7314150124084	340	60	1	236
2951-180	7314150102204	340	60	1	236
2951-250	7314150102211	340	60	1	236
2951-300	7314150102228	340	60	1	236
2952-165	7314150103836	340	60	1	237
2952-235	7314150103843	340	60	1	237
2953-140	7314150124046	340	60	1	236
2953-200	7314150124053	340	60	1	236
2953-250	7314150124060	340	60	1	236
2953-300	7314150124077	340	60	1	236
2955-250	7314150102235	340	60	1	237
2957-250	7314150102259	340	60	1	237
2958-140	7314150124107	340	60	1	237
2958-200	7314150124114	340	60	1	237
2958-250	7314150102242	340	60	1	237
296	7311518034146	330	10	1	507
2963-280	7314150102280	340	60	1	238
2963-450	7314150124138	340	60	1	238
2963-630	7314150124145	340	60	1	238
2964-160	7314150124183	340	60	1	238
2964-280	7314150102297	340	60	1	238
2964-450	7314150124190	340	60	1	238
2964-600	7314150124206	340	60	1	238
2965-200	7314150124152	340	60	1	238
2965-280	7314150102266	340	60	1	238
2966-280	7314150102273	340	60	1	238
2967-180	7314150102396	340	60	1	239
2968-190	7314150124091	340	60	1	237
2968-235	7314150103850	340	60	1	237
2970G-200	7314150134946	340	75	5	219
2971G-250	7314150117154	340	75	5	226
2979 D-180	7314150034246	340	55	5	224
2990-125	7314150121250	340	30	3	228
2990-140	7314150034482	340	30	3	228
2990-180	7314150034505	340	30	3	228
2990-200	7314150034529	340	30	3	228
2990-300	7314150121267	340	30	3	228
2997-250	7314150124237	340	60	1	238
2997-300	7314150124244	340	60	5	238
2998-250	7314150124213	340	60	1	239
2998-SH	7314150207961	340	60	1	239
2999-250	7314150124169	340	60	1	239
2999-SH	7314150207954	340	60	1	239
29M-10	7314150122318	366	15	5	58
29M-11	7314150122325	366	15	5	58
29M-12	7314150122332	366	15	5	58
29M-13	7314150122349	366	15	5	58
29M-14	7314150122356	366	15	5	58
29M-15	7314150122363	366	15	5	58
29M-16	7314150122370	366	15	5	58
29M-17	7314150122387	366	15	5	58
29M-18	7314150122394	366	15	3	58
29M-19	7314150122400	366	15	3	58
29M-20	7314150122417	366	15	3	58
29M-21	7314150122424	366	15	3	58
29M-22	7314150122431	366	15	3	58
29M-23	7314150122448	366	15	3	58
29M-24	7314150122455	366	15	3	58
29M-25	7314150122462	366	15	3	58
29M-26	7314150122479	366	15	3	58
29M-27	7314150122486	366	15	3	58
29M-28	7314150122493	366	15	1	58
29M-29	7314150122509	366	15	1	58
29M-30	7314150122516	366	15	1	58
29M-32	7314150122523	366	15	1	58
29M-6	7314150122271	366	15	5	58
29M-7	7314150122288	366	15	5	58
29M-8	7314150122295	366	15	5	58
29M-9	7314150122301	366	15	5	58
29M/10	7314150122547	366	15	1	58
29M/14	7314150122554	366	15	1	58
29M/8	7314150122530	366	15	1	58
2M-10-11	7314151001223	366	10	5	53
2M-10-13	7314151001513	366	10	5	53
2M-12-13	7314151001230	366	10	5	53
2M-13-17	7314151343972	366	10	5	53
2M-14-15	7314151001247	366	10	5	53
2M-16-17	7314151001254	366	10	5	53
2M-16-18	7314151001575	366	10	5	53
2M-17-19	7314151000844	366	10	5	53
2M-18-19	7314151001261	366	10	5	53
2M-19-22	7314151000868	366	10	5	53
2M-20-22	7314151001278	366	10	5	53
2M-21-23	7314151001285	366	10	5	53
2M-22-24	7314151001612	366	10	5	53
2M-24-26	7314151001292	366	10	5	53
2M-24-27	7314151000899	366	10	5	53



CUENTA SUBGRUPO



2M-25-28	7314151001308	366	10	5	53
2M-27-29	7314150205332	366	10	1	53
2M-27-30	7314151001636	366	10	5	53
2M-27-32	7314151001322	366	10	5	53
2M-30-32	7314151000929	366	10	5	53
2M-32-36	7314151001667	366	10	1	53
2M-36-41	7314151001681	366	10	1	53
2M-41-46	7314151001704	366	10	1	53
2M-46-50	7314151001711	366	10	1	53
2M-6-7	7314151001209	366	10	5	53
2M-8-10	7314151001506	366	10	5	53
2M-8-9	7314151001216	366	10	5	53
2M/10T	7314150212996	366	10	1	53
2M/12T	7314151001414	366	10	1	53
2M/13	7314150213016	366	10	1	54
2M/8T	7314151001391	366	10	1	53
2M/S8	7314151827335	366	10	1	53
2MV-10	7314150121113	366	35	5	443
2MV-11	7314150121120	366	35	5	443
2MV-12	7314150121137	366	35	5	443
2MV-13	7314150121144	366	35	5	443
2MV-14	7314150121151	366	35	5	443
2MV-15	7314150121168	366	35	5	443
2MV-16	7314150121175	366	35	5	443
2MV-17	7314150121182	366	35	3	443
2MV-18	7314150121199	366	35	3	443
2MV-19	7314150121205	366	35	3	443
2MV-21	7314150121212	366	35	3	443
2MV-22	7314150121229	366	35	3	443
2MV-23	7314150121236	366	35	3	443
2MV-24	7314150121243	366	35	3	443
2MV-6	7314150121069	366	35	5	443
2MV-7	7314150121083	366	35	5	443
2MV-8	7314150121090	366	35	5	443
2MV-9	7314150121106	366	35	5	443
2Z-1-1/1/8	7314151001827	366	10	1	53
2Z-1.1/16-1.1/4	7314151001834	366	10	1	53
2Z-1/2-9/16	7314151001445	366	10	1	53
2Z-1/4-5/16	7314151001421	366	10	1	53
2Z-13/16-7/8	7314151001797	366	10	1	53
2Z-15/16-1	7314151001810	366	10	1	53
2Z-3/4-7/8	7314151001773	366	10	1	53
2Z-3/8-7/16	7314151001438	366	10	1	53
2Z-5/16-3/8	7314151001728	366	10	1	53
2Z-5/8-11/16	7314151001452	366	10	1	53
2Z-9/16-5/8	7314151001735	366	10	1	53
2Z/7T	7314150217373	366	10	1	54
3-24-51	7315962500028	316	10	5	567
3-330-12-1-0	7311518020712	324	25	5	29
3-330-12-2-0	7311518020729	324	25	5	29
3-330-14-1-0	7311518020736	324	25	5	29
3-330-14-2-0	7311518020743	324	25	5	29
3-331-14-1-0	7311518020750	324	25	5	29
300-14-F15/16-HP	7311518005955	330	10	4	502
301	7311518001384	328	20	5	507
302	7311518013349	328	20	5	507
302-511W-12P	7311518207786	328	20	1	507
302-51W-12P	7311518013356	328	20	1	507
302-53W-12P	7311518013363	328	20	1	507
302-55W-12P	7311518013370	328	20	1	507
302-57W-12P	7311518013387	328	20	1	507
302-59W-12P	7311518207779	328	20	1	507
302-6X4P	7311518017590	328	20	1	507
302-71M-12P	7311518013394	328	20	1	507
302-73M-12P	7311518013400	328	20	1	507
302-75M-12P	7311518013417	328	20	1	507
302-77M-12P	7311518207793	328	20	1	507
302-81S-12P	7311518013677	328	20	1	507
302-83S-12P	7311518013684	328	20	1	507
302-85S-12P	7311518207809	328	20	1	507
303-5P	7311518031435	328	20	10	507
304	7311518265533	328	10	10	498
3045/1VDE	7314151783815	391	30	1	415
3045V-1	7314150128785	391	30	1	415
3045V-2	7314150128792	391	30	1	415
3046-OP	7311518276980	312	30	12	480
3046-REF	7311518276966	312	30	1	278
3049-2	7314151848118	356	30	1	416
306	7311518265540	328	10	10	498
306-10	7314150120246	338	15	1	247
306-12	7314150120253	338	15	1	247
306-15	7311518297107	338	15	12	247
306-15-95	7311518297329	338	15	1	247
306-22	7311518297114	338	15	12	247
306601500	8413345098700	318	10	5	526
306602000	8413345098717	318	10	5	526
306602500	8413345217002	318	10	5	526
306603000	8413345217033	318	10	5	526



CUENTA SUBGRUPO



306803000	8413345098809	318	10	5	526
306804000	8413345098816	318	10	5	526
306805000	8413345098823	318	10	2	526
306806000	8413345098830	318	10	2	526
306808000	8413345098847	318	10	2	526
306810000	8413345098854	318	10	2	526
306812000	8413345098861	318	10	2	526
306815000	8413345098878	318	10	1	526
306820000	8413345098885	318	10	1	526
306903000	8413345123402	318	10	2	526
306904000	8413345123419	318	10	2	526
306905000	8413345123426	318	10	2	526
306906000	8413345123433	318	10	2	526
306908000	8413345123457	318	10	2	526
306910000	8413345123471	318	10	2	526
307401B	7314150254958	338	10	1	246
307411B	7314150254965	338	10	1	246
307421B	7314150254972	338	10	1	246
307431B	7314150254989	338	10	1	246
307441	7314150235933	338	10	1	246
308504000	8413345035156	336	10	1	488
308505000	8413345035194	336	10	1	488
308506000	8413345035163	336	10	1	488
308508000	8413345035170	336	10	1	488
308510000	8413345035187	336	10	1	488
3090-20-XT11-HP	7311518181369	330	10	4	504
31	7314150004942	310	10	5	40
31 IP	7314150004959	310	10	50	40
3100TB	7314150125364	356	30	1	411
310M-24	7314151829612	366	20	1	57
310M-27	7314151829629	366	20	1	57
310M-30	7314151829636	366	20	1	57
310M-32	7314151829643	366	20	1	57
310M-36	7314151829650	366	20	1	57
310M-38	7314151829667	366	20	1	57
310M-41	7314151829674	366	20	1	57
310M-46	7314151829681	366	20	1	57
310M-50	7314151829698	366	20	1	57
310M-55	7314151829704	366	20	1	57
310M-60	7314151829711	366	20	1	57
310M-65	7314151829728	366	20	1	57
310M-70	7314151829735	366	20	1	57
310M-75	7314151829742	366	20	1	57
310M-80	7314151829759	366	20	1	57
310M-85	7314151829766	366	20	1	57
310M-90	7314151829773	366	20	1	57
310M-95	7314151829780	366	20	1	57
3115	7314150055326	322	10	1	336
3149-OR	7311518292249	356	15	1	396
3150-12-XT9-HP	7311518181406	330	10	4	502
315M-27	7314150133291	366	20	1	57
315M-30	7314150133307	366	20	1	57
315M-32	7314150133314	366	20	1	57
315M-36	7314150133321	366	20	1	57
315M-41	7314150133345	366	20	1	57
315M-46	7314150133352	366	20	1	57
315M-50	7314150133369	366	20	1	57
315M-55	7314150133376	366	20	1	57
315M-60	7314150133383	366	20	1	57
315M-65	7314150133390	366	20	1	57
315M-70	7314150133406	366	20	1	57
315M-75	7314150133413	366	20	1	57
315M-80	7314150133420	366	20	1	57
315Z-1.1/16	7314150133437	366	20	1	57
315Z-1.1/2	7314150133505	366	20	1	57
315Z-1.1/4	7314150133468	366	20	1	57
315Z-1.1/8	7314150133444	366	20	1	57
315Z-1.11/16	7314150133529	366	20	1	57
315Z-1.13/16	7314150133543	366	20	1	57
315Z-1.15/16	7314150133567	366	20	1	57
315Z-1.3/16	7314150133451	366	20	1	57
315Z-1.3/4	7314150133536	366	20	1	57
315Z-1.3/8	7314150133482	366	20	1	57
315Z-1.5/16	7314150133475	366	20	1	57
315Z-1.5/8	7314150133512	366	20	1	57
315Z-1.7/16	7314150133499	366	20	1	57
315Z-1.7/8	7314150133550	366	20	1	57
315Z-2	7314150133574	366	20	1	57
315Z-2.1/16	7314150133581	366	20	1	57
315Z-2.1/2	7314150133642	366	20	1	57
315Z-2.1/4	7314150133611	366	20	1	57
315Z-2.1/8	7314150133598	366	20	1	57
315Z-2.15/16	7314150133697	366	20	1	57
315Z-2.3/16	7314150133604	366	20	1	57
315Z-2.3/4	7314150133673	366	20	1	57
315Z-2.3/8	7314150133635	366	20	1	57
315Z-2.5/16	7314150133628	366	20	1	57
315Z-2.5/8	7314150133666	366	20	1	57
315Z-2.7/8	7314150133680	366	20	1	57
315Z-2.9/16	7314150133659	366	20	1	57
315Z-3	7314150133703	366	20	1	57
315Z-3.1/8	7314150133840	366	20	1	57
316-1	7311518296216	338	15	12	248
316-2	7311518296223	338	15	12	248
316-2-95	7311518296278	338	15	1	248
317	7311518240936	328	10	10	498
317-40	7311518296230	338	15	12	248
318-38	7311518296247	338	15	1	248



CUENTA SUBGRUPO



318-54	7311518296254	338	15	1	248
3180-14-XT11-HP	7311518181390	330	10	4	504
319	7311518240943	328	10	5	498
320	7311518265557	328	10	10	498
321	7311518001841	328	30	5	498
321-18-SB	7311518129125	328	30	10	500
321-24-SB	7311518129132	328	30	10	500
321-7-SB	7311518129149	328	30	10	500
322500300	8413345012829	340	85	1	478
322500500	8413345012836	340	85	1	478
322500800	8413345012843	340	85	1	478
322510300	8413345015899	340	85	1	479
322510400	8413345137386	340	85	1	479
322510500	8413345015905	340	85	1	479
322510600	8413345137393	340	85	1	479
322510700	8413345137409	340	85	1	479
322510800	8413345015912	340	85	1	479
3240-14-XT11-HP	7311518243005	330	10	4	504
325	7311518214852	328	10	5	498
325001000	8413345000505	340	85	1	478
3250010SH	8413345137492	340	85	1	478
326000200	8413345000529	340	85	1	478
326000300	8413345012881	340	85	1	478
326010200	8413345016100	340	85	1	479
326020200	8413345016117	340	85	1	479
326030200	8413345016124	340	85	1	479
327020500	7314150330584	340	85	1	478
327020500-SH1	7314150361021	340	85	1	479
327020500-SH2	7314150361038	340	85	1	479
327020500-SH3	7314150361045	340	85	1	479
327020500-SH4	7314150361052	340	85	1	479
328000000	8413345000734	340	85	1	479
3280M	7314151071318	312	10	1	51
329000330	8413345000741	340	85	1	479
329000500	8413345000758	340	85	1	479
329500300	7314150181001	340	85	1	478
329500350	7314150181049	340	85	1	479
329500400	7314150181018	340	85	1	478
329500450	7314150181056	340	85	1	479
329600100	7314150181063	340	85	1	479
329600200	7314150181070	340	85	1	479
329600500	7314150181025	340	85	1	478
329600800	7314150181032	340	85	1	478
331-15-23	7311518274658	316	10	5	568
331-21-51-KP	7311518003814	316	10	5	567
332-21-51	7311518229337	316	10	5	567
333	7311518005832	316	10	5	568
333-5	7311518005849	316	15	10	568
339-6T	7311518128371	330	20	4	563
33H	7314150266791	310	10	5	40
340-6T	7311518002008	330	20	4	563
341	7314150113729	338	10	1	244
3416 A	7314150216260	340	25	1	230
3416 A SH	7314150410941	340	25	1	230
3416 B	7314150411160	340	25	10	230
3416 B SH	7314150411191	340	25	10	230
3417 A	7314150216277	340	25	12	230
3418 A	7314150216284	340	25	1	230
3419 B	7314151812416	340	25	1	231
3419 EB	7314151812621	340	25	1	231
342	7314150113736	338	10	1	244
343	7314150113743	338	10	1	244
344	7314150113750	338	10	1	244
349	7311518018924	330	20	4	568
3517 A	7314150410910	340	25	1	230
3518 A	7314150216376	340	25	1	230
3518 A SH	7314150216383	340	25	1	230
3518 B	7314150410927	340	25	1	231
3520 A	7314150410934	340	25	1	231
3520 A SH	7314150410958	340	25	1	231
3520 B	7314150411177	340	25	10	231
3520 B SH	7314150411207	340	25	10	231
3524	7314151073336	362	10	1	480
3524-K	7314151339807	362	10	1	480
3525HB	7314151073350	362	10	5	480
36	7314150223381	340	45	5	530
361-10	7311518295202	338	10	1	245
361-12	7311518295219	338	10	1	245
361-14	7311518295226	338	10	1	245
361-18	7311518295233	338	10	1	245
361-24	7311518295240	338	10	1	245
361-36	7311518295257	338	10	1	245
361-8	7311518295196	338	10	1	245
3619 A	7314150411184	340	25	10	231
3619 A SH	7314150411214	340	25	10	231
3625AR-35	7314150214723	358	10	6	533
3625AR-50	7314150214730	358	10	6	533
3625AR-60	73141502				

3625NL-35

	CUENTA	SUBGRUPO			
3625NL-35	7314151073862	358	10	1	534
3625NL-40	7314151073879	358	10	1	534
3625NL-50	7314151073886	358	10	1	534
3625NL-60	7314151073893	358	10	1	534
3625PU-105	7314150170098	358	10	1	533
3625PU-30	7311518276119	358	10	12	533
3625PU-50	7311518276126	358	10	6	533
3625PU-60	7311518276133	358	10	6	533
3625RM-55	7314150120758	358	10	1	535
3625RM-65	7314150120765	358	10	1	535
3625RM-75	7314153019820	358	10	1	535
3625RM-90	7314150120390	358	10	1	535
3625S-28	7314150183906	358	10	6	535
3625S-35	7314150183913	358	10	6	535
3625S-44	7314150183920	358	10	6	535
3625W-22	7314150120406	358	10	6	534
3625W-28	7314150120413	358	10	6	534
3625W-35	7314150120420	358	10	6	534
3625W-44	7314150120437	358	10	6	534
3625W-55	7314150120444	358	10	6	534
3625WL-22	7314150120451	358	10	10	534
3625WL-28	7314150120468	358	10	10	534
3625WL-35	7314150120475	358	10	10	534
3625WL-44	7314150120482	358	10	10	534
3625WL-55	7314150120499	358	10	6	534
3625Y-22	7314151074074	358	10	1	534
3625Y-27	7314151074081	358	10	1	534
3625Y-32	7314151074098	358	10	1	534
3625Y-35	7314151074104	358	10	1	534
3625Y-40	7314151074111	358	10	1	534
3625Y-50	7314151074128	358	10	1	534
3625Y-60	7314151074135	358	10	1	534
3625YL-22	7314151074159	358	10	1	534
3625YL-27	7314151074166	358	10	1	534
3625YL-32	7314151074173	358	10	1	534
3625YL-35	7314151074180	358	10	1	534
3625YL-40	7314151074197	358	10	1	534
3625YL-50	7314151074203	358	10	1	534
3625YL-60	7314151074210	358	10	1	534
363-32	7311518295578	338	10	1	245
3640-150-C	7314150180691	358	15	6	542
3640-175-C	7314150180707	358	15	6	542
3640-200-C	7314150180714	358	15	5	542
3640-250-C	7314150180721	358	15	5	542
3640-300-C	7314150180738	358	15	6	542
3643-100	7314151074654	358	15	5	543
3643-120	7314151074678	358	15	5	543
3643-150	7314151074685	358	15	5	543
3644-120	7314151074708	358	15	5	544
3644-125	7314151074722	358	15	5	544
3644-130	7314151074746	358	15	5	544
3644-150	7314151074760	358	15	5	544
3644-165	7314151074777	358	15	5	544
3644-180	7314151074791	358	15	5	544
3644-200	7314151074807	358	15	5	544
3646-115	7314151074937	358	15	5	544
3646-125	7314151074944	358	15	5	544
3646-150	7314151074951	358	15	5	544
3646-165	7314151074968	358	15	5	544
3646-180	7314151074975	358	15	5	544
3646-200	7314151074982	358	15	5	544
3646/6	7314151074999	358	15	1	545
3654BMS/7	7314150220816	358	15	1	543
3654R	7314151075132	358	15	1	545
3656/10	7314151075279	358	15	1	545
3658A-2	7314151075293	358	15	5	544
3658A-3	7314151075309	358	15	5	544
3658A-4	7314151075316	358	15	5	544
3658A-5	7314151075323	358	15	5	544
3658A-6	7314151075330	358	15	5	544
3658A-8	7314151075347	358	15	5	544
3658A/6	7314151075354	358	15	1	545
3659-0.9	7314151075507	358	15	5	544
3659-1.4	7314151075514	358	15	5	544
3659-1.8	7314151597351	358	15	5	544
3659-2.4	7314151075538	358	15	5	544
3659-2.8	7314151597436	358	15	5	544
3659-3.4	7314151075552	358	15	5	544
3659-3.9	7314151075569	358	15	5	544
3659-6.0	7314151075576	358	15	5	544
3659/8	7314151075583	358	15	1	545
3659/8T	7314151472573	358	15	1	545
3680	7314151075835	322	25	1	343
3681-11	7314150132980	322	25	1	343
3681-16	7314150132997	322	25	1	343
3681-20	7314150133000	322	25	1	343
3683	7314151075866	322	25	1	343
3684-16	7314150133017	322	25	50	343
3684-18	7314150133024	322	25	1	343
3684-24	7314150133031	322	25	1	343
3684-30	7314150133048	322	25	1	343
369-BLADE	7311518016531	330	10	20	502
370-4	7311518296193	338	10	1	246
372-1.1/2	7314150133239	338	10	1	246
372-1.2	7314150133284	338	10	1	246
372-2.1/2	7314150133246	338	10	1	246
372-4	7314150133253	338	10	1	246
372-6	7314150133260	338	10	1	246

	CUENTA	SUBGRUPO			
372-8	7314150133277	338	10	1	246
3733-2	7314151834371	358	15	5	544
3733-3	7314151834388	358	15	5	544
3733-4	7314151834395	358	15	5	544
3733-5	7314151834401	358	15	5	544
3733-6	7314151834418	358	15	5	544
3733S/5	7314150220809	358	15	1	545
3734-2	7314151834296	358	15	5	544
3734-3	7314151834319	358	15	5	544
3734-4	7314151834326	358	15	5	544
3734-5	7314151834333	358	15	5	544
3734-6	7314151834340	358	15	5	544
3734-8	7314151834357	358	15	5	544
3734BMS/7	7314150220755	358	15	1	547
3734N-10-150	7314150218110	358	15	10	544
3734N-2-150	7314150218042	358	15	10	544
3734N-3-150	7314150218059	358	15	10	544
3734N-4-150	7314150218066	358	15	10	544
3734N-5-150	7314150218073	358	15	10	544
3734N-6-150	7314150218080	358	15	10	544
3734N-7-150	7314150218097	358	15	10	544
3734N-8-150	7314150218103	358	15	10	544
3734N-9-150	7314150218127	358	15	10	544
3734NS/9	7314150218134	358	15	10	545
3734S/6	7314151834470	358	15	1	545
3735-4-120	7314151834265	358	15	5	543
3735-5-120	7314151834272	358	15	5	543
3735-5-150	7314151834289	358	15	5	543
3735N-2-100	7314150217953	358	15	10	543
3735N-4-120	7314150217960	358	15	10	543
3735N-5-120	7314150217977	358	15	10	543
3735N-6-150	7314150217984	358	15	10	543
3735N-8-150	7314150217991	358	15	10	543
3735NS/4	7314150218004	358	15	25	544
3736M-200	7314150220878	358	15	5	542
3736M-250	7314151834142	358	15	5	542
3736M-300	7314151834159	358	15	5	542
3736M-400	7314151834166	358	15	5	542
3736MH-250	7314151834173	358	15	2	543
3736MH-300	7314151834180	358	15	2	543
3736MH-400	7314151834197	358	15	2	543
3736S/6	7314151834463	358	15	1	542
3739-250	7314151834203	358	15	5	542
3739-300	7314151834210	358	15	5	542
3739-400	7314151834227	358	15	5	542
3739H-250	7314151834234	358	15	2	543
3739H-300	7314151834241	358	15	2	543
3739H-400	7314151834258	358	15	2	543
3740-100	7314151834005	358	15	5	542
3740-125	7314151834012	358	15	5	542
3740-150	7314151834029	358	15	1	542
3740-175	7314151834036	358	15	5	542
3740-200	7314151834043	358	15	5	542
3740-250	7314151834050	358	15	5	542
3740-300	7314151834067	358	15	5	542
3745-150	7314151834081	358	15	5	542
3745-175	7314151834098	358	15	5	542
3745-200	7314151834104	358	15	5	542
3745-250	7314151834111	358	15	5	542
375-8	7311518296209	338	10	1	246
3750	7314151834128	358	15	5	542
3750H	7314151834135	358	15	1	542
38	7314150021734	340	45	1	530
38-12	7314151831264	312	25	5	304
38-16	7314151831271	312	25	5	304
38-20	7314151831288	312	25	2	304
38-24	7314151831295	312	25	1	304
38-8	7314151831257	312	25	5	304
380-10	7314150133178	338	10	1	245
380-14	7314150133185	338	10	1	245
380-18	7314150133192	338	10	1	245
380-24	7314150133208	338	10	1	245
380-36	7314150133215	338	10	1	245
380-48	7314150133222	338	10	1	245
3802-300-25-1.25-10	7311518111229	342	15	10	20
3802-300-25-1.25-14	7311518111236	342	15	10	20
3802-300-25-1.25-6	7311518143299	342	15	10	20
3802-300-32-1.60-10	7311518111274	342	15	10	20
3802-300-32-1.60-6	7311518111298	342	15	10	20
3802-350-25-1.25-10	7311518111335	342	15	10	20
3802-350-25-1.25-14	7311518111342	342	15	10	20
3802-350-25-1.25-6	7311518111359	342	15	10	20
3802-350-32-1.60-10	7311518111397	342	15	10	20
3802-350-32-1.60-14	7311518111403	342	15	10	20
3802-350-32-1.60-4	7311518111410	342	15	10	20
3802-350-32-1.60-6	7311518111427	342	15	10	20
3802-350-32-1.60-8	7311518140908	342	15	10	20
3802-400-25-					



CUENTA SUBGRUPO



3802-425-32-1.60-10	7311518111694	342	15	10	20
3802-425-32-1.60-6	7311518111700	342	15	10	20
3802-450-32-1.60-10	7311518111731	342	15	10	20
3802-450-32-1.60-14	7311518111748	342	15	10	20
3802-450-32-1.60-4	7311518111755	342	15	10	20
3802-450-32-1.60-6	7311518111762	342	15	10	20
3802-450-38-2.00-10	7311518111816	342	15	10	20
3802-450-38-2.00-10-KA	7311518111823	342	15	10	20
3802-450-38-2.00-4	7311518111830	342	15	10	20
3802-450-38-2.00-4-KA	7311518111847	342	15	10	20
3802-450-38-2.00-6	7311518111854	342	15	10	20
3802-450-38-2.00-6-KA	7311518111861	342	15	10	20
3802-450-38-2.00-8	7311518111878	342	15	10	20
3802-450-38-2.00-8-KA	7311518111885	342	15	10	20
3802-475-38-2.00-8	7311518111317	342	15	10	20
3802-500-38-2.00-10	7311518111953	342	15	10	20
3802-500-38-2.00-4	7311518111960	342	15	10	20
3802-500-38-2.00-6	7311518111977	342	15	10	20
3802-500-38-2.00-8	73115181113070	342	15	10	20
3802-500-45-2.25-10	7311518111984	342	15	10	20
3802-500-50-2.50-4	73115181112028	342	15	10	20
3802-500-50-2.50-4-KA	7311518112035	342	15	10	20
3802-500-50-2.50-6	7311518112042	342	15	10	20
3802-500-50-2.50-6-KA	7311518112059	342	15	10	20
3802-525-38-2.00-10	7311518112073	342	15	10	20
3802-525-38-2.00-6	7311518112097	342	15	10	20
3802-525-38-2.00-8	7311518112103	342	15	10	20
3802-550-38-2.00-6	7311518112158	342	15	10	20
3802-550-50-2.50-10	7311518112196	342	15	10	20
3802-550-50-2.50-4	7311518112202	342	15	10	20
3802-550-50-2.50-4-KA	7311518112219	342	15	10	20
3802-550-50-2.50-6	7311518112226	342	15	10	20
3802-550-50-2.50-8	7311518112240	342	15	5	20
3802-550-50-2.50-8-KA	7311518113315	342	15	10	20
3802-575-50-2.50-3-KA	7311518112301	342	15	10	20
3802-575-50-2.50-4	7311518112318	342	15	10	20
3802-575-50-2.50-4-KA	7311518112325	342	15	10	20
3802-575-50-2.50-6	7311518112332	342	15	10	20
3802-575-50-2.50-6-KA	7311518112349	342	15	10	20
3802-600-50-2.50-4	7311518112417	342	15	10	20
3802-600-50-2.50-6	7311518112431	342	15	10	20
3802-600-50-2.50-8	7311518112455	342	15	10	20
3802-650-50-2.50-4	7311518112509	342	15	5	20
3802-650-50-2.50-4-KA	7311518112523	342	15	5	20
3802-650-50-2.50-6	7311518112530	342	15	5	20
3802-650-50-2.50-6-KA	7311518112554	342	15	5	20
3802-700-50-2.50-2-KA	7311518112578	342	15	5	20
3802-700-50-2.50-3	7311518112585	342	15	5	20
3802-700-50-2.50-4	7311518112608	342	15	5	20
3802-700-50-2.50-4-KA	7311518112615	342	15	5	20
3802-700-50-2.50-6	7311518112622	342	15	5	20
3802-700-50-2.50-6-KA	7311518112639	342	15	5	20
3802-750-50-2.50-4	7311518112660	342	15	5	20
3802-750-50-2.50-6	7311518112677	342	15	5	20
3806-600-32	7311518018092	328	15	10	499
3809-300-25-1.25-10	7311518113711	342	10	10	19
3809-300-25-1.25-14	7311518113728	342	10	10	19
3809-300-32-1.60-10	7311518113735	342	10	10	19
3809-300-32-1.60-6	7311518113742	342	10	10	19
3809-350-25-1.25-10	7311518113759	342	10	10	19
3809-350-25-1.25-14	7311518113766	342	10	10	19
3809-350-25-1.25-6	7311518113773	342	10	10	19
3809-350-32-1.60-10	7311518113780	342	10	10	19
3809-350-32-1.60-14	7311518113797	342	10	10	19
3809-350-32-1.60-4	7311518113803	342	10	10	19
3809-350-32-1.60-6	7311518113810	342	10	10	19
3809-350-32-1.60-8	7311518113827	342	10	10	19
3809-350-32-2.00-10	7311518113834	342	10	10	19
3809-350-32-2.00-4	7311518113841	342	10	10	19
3809-350-32-2.00-6	7311518113858	342	10	10	19
3809-350-38-2.00-10	7311518113865	342	10	10	19
3809-350-38-2.00-6	7311518113889	342	10	10	19
3809-400-25-1.25-10	7311518178666	342	10	10	19
3809-400-32-1.60-10	7311518113896	342	10	10	19
3809-400-32-1.60-14	7311518113902	342	10	10	19
3809-400-32-1.60-4	7311518113919	342	10	10	19
3809-400-32-1.60-6	7311518113933	342	10	10	19
3809-400-32-1.60-8	7311518113940	342	10	10	19
3809-400-32-2.00-10	7311518113957	342	10	10	19
3809-400-32-2.00-4	7311518113964	342	10	10	19
3809-400-32-2.00-6	7311518113971	342	10	10	19
3809-400-32-2.00-6-KA	7311518158248	342	10	10	20
3809-400-32-2.00-8	7311518114152	342	10	10	19
3809-400-38-2.00-10	7311518113988	342	10	10	19
3809-400-38-2.00-4	7311518113995	342	10	10	19
3809-400-38-2.00-6	7311518114008	342	10	10	19
3809-425-32-1.60-10	7311518114015	342	10	10	19
3809-425-32-1.60-6	7311518197759	342	10	10	19
3809-450-32-1.60-10	7311518114022	342	10	10	19
3809-450-32-1.60-14	7311518114039	342	10	10	19
3809-450-32-1.60-4	7311518114046	342	10	10	19
3809-450-32-1.60-6	7311518114053	342	10	10	19
3809-450-32-2.00-10	7311518114060	342	10	10	19
3809-450-32-2.00-4	7311518114077	342	10	10	19
3809-450-32-2.00-6	7311518114084	342	10	10	19
3809-450-38-2.00-10	7311518114091	342	10	10	19
3809-450-38-2.00-10-KA	7311518114107	342	10	10	20
3809-450-38-2.00-4	7311518114114	342	10	10	19



CUENTA SUBGRUPO



3809-450-38-2.00-4-KA	7311518114121	342	10	10	20
3809-450-38-2.00-6	7311518114138	342	10	10	19
3809-450-38-2.00-6-KA	7311518114145	342	10	10	20
3809-450-38-2.00-8	7311518114176	342	10	10	19
3809-450-45-2.25-4	7311518114206	342	10	10	19
3809-450-45-2.25-6	7311518114213	342	10	10	19
3809-475-45-2.25-6	7311518114237	342	10	10	19
3809-500-38-2.00-10	7311518114244	342	10	10	19
3809-500-38-2.00-4	7311518114251	342	10	10	19
3809-500-38-2.00-6	7311518114268	342	10	10	19
3809-500-45-2.25-4	7311518114275	342	10	10	19
3809-500-45-2.25-6	7311518114299	342	10	10	19
3809-500-45-2.25-6-KA	7311518114305	342	10	10	20
3809-500-50-2.50-4	7311518114312	342	10	10	19
3809-500-50-2.50-4-KA	7311518114329	342	10	10	20
3809-500-50-2.50-6	7311518114336	342	10	10	19
3809-500-50-2.50-6-KA	7311518114343	342	10	10	20
3809-500-50-2.50-8	7311518114350	342	10	10	19
3809-525-38-2.00-10	7311518114367	342	10	10	19
3809-525-38-2.00-6	7311518114374	342	10	10	19
3809-525-45-2.25-4	7311518114381	342	10	10	19
3809-525-45-2.25-6	7311518114398	342	10	10	19
3809-550-45-2.25-4	7311518114411	342	10	10	19
3809-550-45-2.25-6	7311518114428	342	10	10	19
3809-550-50-2.50-4	7311518114435	342	10	10	19
3809-550-50-2.50-4-KA	7311518114442	342	10	10	20
3809-550-50-2.50-6	7311518114459	342	10	10	19
3809-550-50-2.50-6-KA	7311518114466	342	10	10	20
3809-575-45-2.25-4	7311518114473	342	10	10	19
3809-575-50-2.50-10-KA	7311518114497	342	10	10	20
3809-575-50-2.50-3	7311518114602	342	10	10	19
3809-575-50-2.50-3-KA	7311518114503	342	10	10	20
3809-575-50-2.50-4	7311518114510	342	10	10	19
3809-575-50-2.50-4-KA	7311518114527	342	10	10	20
3809-575-50-2.50-6	7311518114534	342	10	10	19
3809-575-50-2.50-6-KA	7311518114541	342	10	10	20
3809-600-38-2.00-6	7311518227579	342	10	10	19
3809-600-45-2.25-4	7311518172275	342	10	10	19
3809-600-45-2.25-6	7311518114558	342	10	10	19
3809-600-50-2.50-3	7311518114565	342	10	10	19
3809-600-50-2.50-4	7311518114572	342	10	10	19
3809-600-50-2.50-4-KA	7311518114589	342	10	10	20
3809-600-50-2.50-6	7311518114596	342	10	10	19
3809-600-50-2.50-6-KA	7311518114626	342	10	10	20
3809-650-50-2.50-3-KA	7311518114640	342	10	5	20
3809-650-50-2.50-4	7311518114657	342	10	5	19
3809-650-50-2.50-4-KA	7311518114664	342	10	5	20
3809-650-50-2.50-6	7311518114671	342	10	5	19
3809-650-50-2.50-6-KA	7311518114688	342	10	5	20
3809-700-50-2.50-3-KA	7311518114695	342	10	5	20
3809-700-50-2.50-4	7311518114701	342	10	5	19
3809-700-50-2.50-4-KA	7311518114718	342	10	5	20
3809-700-50-2.50-6	7311518114725	342	10	5	19
3809-700-50-2.50-6-KA	7311518114732	342	10	5	20
3809-750-50-2.50-4	7311518114749	342	10	5	19
3809-750-50-2.50-6	7311518234409	342	10	5	19
3815-200-2.0-32-1-03BW	7311518160258	346	10	1	17
3815-200-2.0-32-1-04BW	7311518160241	346	10	1	17
3815-225-2.0-32-1-03BW	7311518160319	346	10	1	17
3815-225-2.0-32-1-04BW	7311518158347	346	10		

3816-300



CUENTA SUBGRUPO



3816-300	7311518015749	328	20	5	499
3818-300-PROG-100	7311518288105	328	15	100	500
3818-300-PROG-5P	7314150265589	328	15	10	500
383-6T	7311518128876	330	20	4	563
3830-102-C	7311518225612	332	10	1	135
3830-102-VIP	7311518042035	332	10	4	135
3830-105-C	7311518225629	332	10	1	135
3830-105-VIP	7311518042042	332	10	4	135
3830-108-C	7311518228521	332	10	1	135
3830-108-VIP	7311518042059	332	10	4	135
3830-111-C	7311518228538	332	10	1	135
3830-111-VIP	7311518042066	332	10	4	135
3830-114-C	7311518225636	332	10	1	135
3830-114-VIP	7311518042073	332	10	4	135
3830-121-C	7311518225643	332	10	1	135
3830-121-VIP	7311518042080	332	10	1	135
3830-127-C	7311518225650	332	10	1	135
3830-127-VIP	7311518042097	332	10	1	135
3830-133-C	7311518228545	332	10	1	135
3830-133-VIP	7311518042103	332	10	1	135
3830-14-C	7311518228347	332	10	1	135
3830-14-VIP	7311518041618	332	10	6	135
3830-140-C	7311518228552	332	10	1	135
3830-140-VIP	7311518042110	332	10	1	135
3830-146-C	7311518228569	332	10	1	135
3830-146-VIP	7311518042127	332	10	1	135
3830-152-C	7311518225667	332	10	1	135
3830-152-VIP	7311518042134	332	10	1	135
3830-16-C	7311518225353	332	10	1	135
3830-16-VIP	7311518041625	332	10	6	135
3830-168	7311518040659	332	10	1	135
3830-17-C	7311518228354	332	10	1	135
3830-17-VIP	7311518041632	332	10	6	135
3830-177-HIGH	7311518101329	332	10	1	135
3830-19-C	7311518225360	332	10	1	135
3830-19-VIP	7311518041649	332	10	6	135
3830-20-C	7311518225377	332	10	1	135
3830-20-VIP	7311518041656	332	10	6	135
3830-21-C	7311518228361	332	10	1	135
3830-21-VIP	7311518041663	332	10	6	135
3830-210	7311518040666	332	10	1	135
3830-22-C	7311518225384	332	10	1	135
3830-22-VIP	7311518041670	332	10	6	135
3830-24-C	7311518228378	332	10	1	135
3830-24-VIP	7311518041687	332	10	6	135
3830-25-C	7311518225391	332	10	1	135
3830-25-VIP	7311518041694	332	10	6	135
3830-27-C	7311518225407	332	10	1	135
3830-27-VIP	7311518041700	332	10	6	135
3830-29-C	7311518225414	332	10	1	135
3830-29-VIP	7311518041717	332	10	6	135
3830-30-C	7311518225421	332	10	1	135
3830-30-VIP	7311518041724	332	10	6	135
3830-32-C	7311518225438	332	10	1	135
3830-32-VIP	7311518041731	332	10	6	135
3830-33-C	7311518228385	332	10	1	135
3830-33-VIP	7311518041748	332	10	6	135
3830-35-C	7311518225445	332	10	1	135
3830-35-VIP	7311518041755	332	10	6	135
3830-37-C	7311518228392	332	10	1	135
3830-37-VIP	7311518041762	332	10	6	135
3830-38-C	7311518225452	332	10	1	135
3830-38-VIP	7311518041779	332	10	6	135
3830-40-C	7311518228408	332	10	1	135
3830-40-VIP	7311518041786	332	10	6	135
3830-41-C	7311518225469	332	10	1	135
3830-41-VIP	7311518041793	332	10	6	135
3830-43-C	7311518228415	332	10	1	135
3830-43-VIP	7311518041809	332	10	6	135
3830-44-C	7311518225476	332	10	1	135
3830-44-VIP	7311518041816	332	10	6	135
3830-46-C	7311518228422	332	10	1	135
3830-46-VIP	7311518041823	332	10	6	135
3830-48-C	7311518225483	332	10	1	135
3830-48-VIP	7311518041830	332	10	6	135
3830-50-C	7311518260873	332	10	1	135
3830-50-VIP	7311518260866	332	10	6	135
3830-51-C	7311518225490	332	10	1	135
3830-51-VIP	7311518041847	332	10	6	135
3830-52-C	7311518228439	332	10	1	135
3830-52-VIP	7311518041854	332	10	4	135
3830-54-C	7311518225506	332	10	1	135
3830-54-VIP	7311518041861	332	10	4	135
3830-55-C	7311518270919	332	10	1	135
3830-55-VIP	7311518270902	332	10	4	135
3830-56-C	7311518228446	332	10	1	135
3830-56-VIP	7311518152703	332	10	4	135
3830-57-C	7311518225513	332	10	1	135
3830-57-VIP	7311518041878	332	10	4	135
3830-59-C	7311518228453	332	10	1	135
3830-59-VIP	7311518041885	332	10	4	135
3830-60-C	7311518225520	332	10	1	135
3830-60-VIP	7311518041892	332	10	4	135
3830-62-VIP	7311518234645	332	10	4	135
3830-64-C	7311518225537	332	10	1	135
3830-64-VIP	7311518041908	332	10	4	135
3830-65-C	7311518228460	332	10	1	135
3830-65-VIP	7311518041915	332	10	4	135



CUENTA SUBGRUPO



3830-67-C	7311518225544	332	10	1	135
3830-67-VIP	7311518041922	332	10	4	135
3830-68-C	7311518228477	332	10	1	135
3830-68-VIP	7311518196530	332	10	4	135
3830-70-C	7311518225551	332	10	1	135
3830-70-VIP	7311518041939	332	10	4	135
3830-73-C	7311518228484	332	10	1	135
3830-73-VIP	7311518041946	332	10	4	135
3830-76-C	7311518225568	332	10	1	135
3830-76-VIP	7311518041953	332	10	4	135
3830-79-C	7311518228491	332	10	1	135
3830-79-VIP	7311518041960	332	10	4	135
3830-83-C	7311518225575	332	10	1	135
3830-83-VIP	7311518041977	332	10	4	135
3830-86-C	7311518228507	332	10	1	135
3830-86-VIP	7311518041984	332	10	4	135
3830-89-C	7311518225582	332	10	1	135
3830-89-VIP	7311518041991	332	10	4	135
3830-92-C	7311518225599	332	10	1	135
3830-92-VIP	7311518042004	332	10	4	135
3830-95-C	7311518225605	332	10	1	135
3830-95-VIP	7311518042011	332	10	4	135
3830-98-C	7311518228514	332	10	1	135
3830-98-VIP	7311518042028	332	10	4	135
3832-102	7311518558567	332	15	4	135
3832-105	7311518558581	332	15	4	135
3832-108	7311518558604	332	15	4	135
3832-111	7311518558611	332	15	4	135
3832-114	7311518558628	332	15	4	135
3832-121	7311518558642	332	15	1	135
3832-127	7311518558666	332	15	1	135
3832-133	7311518558673	332	15	1	135
3832-14	7311518557744	332	15	6	135
3832-140	7311518558680	332	15	1	135
3832-146	7311518558697	332	15	1	135
3832-152	7311518558703	332	15	1	135
3832-16	7311518557768	332	15	6	135
3832-17	7311518557782	332	15	6	135
3832-19	7311518557805	332	15	6	135
3832-20	7311518557812	332	15	6	135
3832-21	7311518557829	332	15	6	135
3832-22	7311518557843	332	15	6	135
3832-24	7311518557867	332	15	6	135
3832-25	7311518557881	332	15	6	135
3832-27	7311518557904	332	15	6	135
3832-29	7311518557928	332	15	6	135
3832-30	7311518557942	332	15	6	135
3832-32	7311518557966	332	15	6	135
3832-33	7311518557980	332	15	6	135
3832-35	7311518558000	332	15	6	135
3832-37	7311518558024	332	15	6	135
3832-38	7311518558048	332	15	6	135
3832-40	7311518558062	332	15	6	135
3832-41	7311518558086	332	15	6	135
3832-43	7311518558109	332	15	6	135
3832-44	7311518558123	332	15	6	135
3832-46	7311518558147	332	15	6	135
3832-48	7311518558161	332	15	6	135
3832-51	7311518558185	332	15	6	135
3832-52	7311518558208	332	15	4	135
3832-54	7311518558222	332	15	4	135
3832-56	7311518558239	332	15	4	135
3832-57	7311518558246	332	15	4	135
3832-59	7311518558260	332	15	4	135
3832-60	7311518558284	332	15	4	135
3832-64	7311518558307	332	15	4	135
3832-65	7311518558321	332	15	4	135
3832-67	7311518558345	332	15	4	135
3832-68	7311518558352	332	15	4	135
3832-70	7311518558369	332	15	4	135
3832-73	7311518558383	332	15	4	135
3832-76	7311518558406	332	15	4	135
3832-79	7311518558420	332	15	4	135
3832-83	7311518558444	332	15	4	135
3832-86	7311518558468	332	15	4	135
3832-89	7311518558482	332	15	4	135
3832-92	7311518558505	332	15	4	135
3832-95	7311518558529	332	15	4	135
3832-98	7311518558543	332	15	4	135
3833-102-C	7314150263899	332	17	1	138
3833-105-C	7314150263905	332	17	1	138
3833-108-C	7314150263912	332	17	1	138
3833-109-C	7314150263929	332	17	1	138
3833-11					



CUENTA SUBGRUPO



3833-25-C	7314150263592	332	17	1	138
3833-27-C	7314150263608	332	17	1	138
3833-29-C	7314150263615	332	17	1	138
3833-30-C	7314150263622	332	17	1	138
3833-32-C	7314150263639	332	17	1	138
3833-35-C	7314150263646	332	17	1	138
3833-38-C	7314150263653	332	17	1	138
3833-40-C	7314150263660	332	17	1	138
3833-41-C	7314150263677	332	17	1	138
3833-44-C	7314150263684	332	17	1	138
3833-48-C	7314150263691	332	17	1	138
3833-51-C	7314150263707	332	17	1	138
3833-54-C	7314150263714	332	17	1	138
3833-56-C	7314150314676	332	17	1	138
3833-57-C	7314150263721	332	17	1	138
3833-60-C	7314150263738	332	17	1	138
3833-62-C	7314150314683	332	17	1	138
3833-64-C	7314150263745	332	17	1	138
3833-65-C	7314150263752	332	17	1	138
3833-67-C	7314150263769	332	17	1	138
3833-68-C	7314150263776	332	17	1	138
3833-70-C	7314150263783	332	17	1	138
3833-71-C	7314150314690	332	17	1	138
3833-73-C	7314150263790	332	17	1	138
3833-74-C	7314150314706	332	17	1	138
3833-76-C	7314150263806	332	17	1	138
3833-77-C	7314150263813	332	17	1	138
3833-78-C	7314150314713	332	17	1	138
3833-79-C	7314150263820	332	17	1	138
3833-83-C	7314150263837	332	17	1	138
3833-86-C	7314150263844	332	17	1	138
3833-89-C	7314150263851	332	17	1	138
3833-92-C	7314150263868	332	17	1	138
3833-95-C	7314150263875	332	17	1	138
3833-98-C	7314150263882	332	17	1	138
3833-SET-101	7314150315383	332	17	1	136
3833-SET-201	7314150315406	332	17	1	136
3833-SET-202	7314150315420	332	17	1	136
3833-SET-203	7314150315444	332	17	1	136
3833-SET-204	7314150315468	332	17	1	136
3833-SET-205	7314150330874	332	17	1	136
3833-SET-207	7314150330898	332	17	1	137
3833-SET-208	7314150330904	332	17	1	137
3833-SET-301	7314150315376	332	17	1	137
3833-SET-302	7314150315390	332	17	1	137
3833-SET-303	7314150315413	332	17	1	137
3833-SET-304	7314150315437	332	17	1	137
3834-ADP	7311518454425	332	20	1	139
3834-ARBR-11152	7311518015596	332	20	1	138
3834-ARBR-11152-C	7311518225698	332	20	1	138
3834-ARBR-11152QC	7311518167967	332	20	1	138
3834-ARBR-11152QC-C	7311518225711	332	20	1	138
3834-ARBR-1130	7311518015572	332	20	4	138
3834-ARBR-1130-C	7311518228583	332	20	1	138
3834-ARBR-16152	7311518015602	332	20	1	138
3834-ARBR-16152QC	7311518453152	332	20	1	138
3834-ARBR-630	7311518015558	332	20	1	138
3834-ARBR-630-C	7311518228576	332	20	1	138
3834-ARBR-730	7311518167974	332	20	1	138
3834-ARBR-730-C	7311518225674	332	20	1	138
3834-ARBR-9100	7311518015589	332	20	1	138
3834-ARBR-9100-C	7311518228590	332	20	1	138
3834-ARBR-9100EL	7314150265077	332	20	1	138
3834-ARBR-9100ESM	7314150390458	332	20	1	138
3834-ARBR-9100QC	7311518249830	332	20	1	138
3834-ARBR-9100QC-C	7311518225704	332	20	1	138
3834-ARBR-930	7311518015565	332	20	1	138
3834-ARBR-930-C	7311518225681	332	20	1	138
3834-ARBR-930EL	7314150265053	332	20	1	138
3834-ARBR-930ESM	7314150390465	332	20	1	138
3834-ARBR-SD152QC	7311518203825	332	20	1	138
3834-ARBR-SD30	7311518203818	332	20	1	138
3834-DRL	7311518234638	332	20	1	139
3834-DRL-CT	7311518953201	332	20	1	139
3834-DRL-EL	7314150265114	332	20	1	138
3834-DRL-ES	7314150265091	332	20	1	138
3834-DRL-HSS-ES	7314150339396	332	20	1	138
3834-DRL-L	7314150265138	332	20	1	139
3834-ES	7311518454418	332	20	1	139
3834-EXT-1	7311518040673	332	20	1	139
3834-EXT-2	7311518168070	332	20	1	139
3834-M6X29-SET	7314150383450	332	20	1	139
3834-M8X10-SET	7314150383429	332	20	1	139
3834-M8X5-SET	7314150383443	332	20	1	139
3834-M8X6-SET	7314150383436	332	20	1	139
3834-SET-103	7314150134908	332	10	1	134
3834-SET-152	7314150255658	332	10	1	134
3834-SET-42	7311518241988	332	10	1	132
3834-SET-53	7314150127153	332	10	1	132
3834-SET-61	7311518266431	332	10	1	132
3834-SET-62	7311518228040	332	10	1	132
3834-SET-62-16/50	7311518258887	332	10	1	132
3834-SET-65-16/51	7311518159900	332	10	1	132
3834-SET-65-22/64	7311518159917	332	10	1	133
3834-SET-72	7311518044992	332	10	1	133
3834-SET-73	7311518254339	332	10	1	133
3834-SET-73-22/68	7314150134809	332	10	1	133
3834-SET-77	7314150235919	332	10	1	133



CUENTA SUBGRUPO



3834-SET-86	7311518224295	332	10	1	133
3834-SET-87	7311518181772	332	10	1	134
3834-SET-92	7311518044985	332	10	1	134
3834-SET-94	7311518166458	332	10	1	134
3834-SET-95	7311518159894	332	10	1	134
3834-UPSIZ	7314150344567	332	20	1	139
384-5T	7311518159795	330	20	4	563
384-6T	7311518002039	330	20	4	563
3845-18-10P	7311518101602	346	35	1	140
3845-24-10P	7311518101619	346	35	1	140
3845-32-10P	7311518101626	346	35	1	140
385-6T	7311518002053	330	20	4	564
3851-10-0.6-10/14	7311518182717	314	10	1	12
3851-10-0.6-H-4	7311518282776	314	10	1	12
3851-10-0.6-H-6	7311518282806	314	10	1	12
3851-10-0.6-HA-4	7314150139309	314	10	1	14
3851-10-0.9-10/14	7311518182823	314	10	1	12
3851-10-0.9-H-4	7311518282851	314	10	1	12
3851-10-0.9-H-6	7311518282868	314	10	1	12
3851-10-0.9-R-14	7314150312399	314	10	1	12
3851-13-0.5-10/14	7311518282813	314	10	1	12
3851-13-0.5-14/18	7311518282790	314	10	1	12
3851-13-0.5-H-4	7311518292072	314	10	1	14
3851-13-0.5-R-10	7311518331306	314	10	1	12
3851-13-0.5-R-14	7311518331320	314	10	1	12
3851-13-0.5-R-18	7311518331344	314	10	1	12
3851-13-0.5-R-24	7311518282820	314	10	1	12
3851-13-0.6-10/14	7311518183271	314	10	1	12
3851-13-0.6-5/8	7311518183233	314	10	1	12
3851-13-0.6-6/10	7311518183240	314	10	1	12
3851-13-0.6-8/12	7311518185572	314	10	1	12
3851-13-0.6-H-3	7311518282769	314	10	1	12
3851-13-0.6-H-4	7311518282745	314	10	1	12
3851-13-0.6-H-6	7311518282738	314	10	1	12
3851-13-0.6-HA-4	7311518282752	314	10	1	14
3851-13-0.6-HA-6	7311518282561	314	10	1	14
3851-13-0.6-R-10	7311518183110	314	10	1	12
3851-13-0.6-R-14	7311518183158	314	10	1	12
3851-13-0.6-R-18	7311518183196	314	10	1	12
3851-13-0.9-10/14	7311518183868	314	10	1	12
3851-13-0.9-6/10	7311518183585	314	10	1	12
3851-13-0.9-H-3	7311518282936	314	10	1	12
3851-13-0.9-H-4	7311518282943	314	10	1	12
3851-13-0.9-H-6	7311518286125	314	10	1	12
3851-13-0.9-HA-4	7311518281052	314	10	1	14
3851-13-0.9-R-14	7311518182359	314	10	1	12
3851-13-0.9-R-6	7311518183301	314	10	1	12
3851-16-0.5-H-3	7314150168989	314	10	1	12
3851-20-0.9-10/14	7311518282585	314	10	1	12
3851-20-0.9-4/6	7311518183905	314	10	1	12
3851-20-0.9-5/8	7311518183929	314	10	1	12
3851-20-0.9-6/10	7311518183936	314	10	1	12
3851-20-0.9-8/12	7311518282578	314	10	1	12
3851-20-0.9-H-2	7314150398270	314	10	1	12
3851-20-0.9-H-3	7314150398515	314	10	1	12
3851-20-0.9-H-4	7314150398294	314	10	1	12
3851-20-0.9-HA-2	7311518329273	314	10	1	14
3851-20-0.9-HA-3	7311518282646	314	10	1	14
3851-20-0.9-HA-4	7311518282653	314	10	1	14
3851-20-0.9-R-18	7311518332587	314	10	1	12
3851-27-0.9-10/14	7311518165475	314	10	1	12
3851-27-0.9-2/3	7311518126377	314	10	1	12
3851-27-0.9-3/4	7311518126384	314	10	1	12
3851-27-0.9-4/6	7311518126391	314	10	1	12
3851-27-0.9-5/8	7311518126407	314	10	1	12
3851-27-0.9-6/10	7311518126414	314	10	1	12
3851-27-0.9-8/12	7311518160692	314	10	1	12
3851-27-0.9-HA-3	7311518282684	314	10	1	14
3851-27-0.9-HA-4	7314150398317	314	10	1	14
3851-27-0.9-P-3	7311518157135	314	10	1	12
3851-27-0.9-P-6	7311518157661	314	10	1	12
3851-27-0.9-R-6	7311518126353	314	10	1	12
3851-34-1.1-2/3	7311518126476	314	10	1	12
3851-34-1.1-3/4	7311518126483	314	10	1	12
3851-34-1.1-4/6	7311518126490	314	10	1	13
3851-34-1.1-5/8	7311518126506	314	10	1	13
3851-34-1.1-6/10	7311518165505				



CUENTA SUBGRUPO



3851-80-1.6-.7/1	7311518255367	314	10	1	13
3851-80-1.6-1.4/2	7311518255350	314	10	1	13
3851-80-1.6-1/1.4	7311518197377	314	10	1	13
3853-20-0.9-5/7-VS	7311518331689	314	10	1	14
3853-20-0.9-8/11-VS	7311518331702	314	10	1	14
3853-27-0.9-3/4	7311518285395	314	10	1	14
3853-27-0.9-4/6	7311518183998	314	10	1	14
3853-27-0.9-5/7-VS	7311518331115	314	10	1	14
3853-27-0.9-5/8	73115182202118	314	10	1	14
3853-27-0.9-8/11-VS	7311518331122	314	10	1	14
3853-34-1.1-2/3	7311518282875	314	10	1	14
3853-34-1.1-3/4	7311518184094	314	10	1	14
3853-34-1.1-4/6	7311518184087	314	10	1	14
3853-34-1.1-5/7-VS	7311518331726	314	10	1	14
3853-34-1.1-5/8	7311518202149	314	10	1	14
3853-34-1.1-8/11-VS	7311518331719	314	10	1	14
3853-41-1.3-2/3	7311518282882	314	10	1	14
3853-41-1.3-3/4	7311518185770	314	10	1	14
3853-41-1.3-4/6	7311518184100	314	10	1	14
3853-41-1.3-5/7-VS	7311518331733	314	10	1	14
3853-41-1.3-5/8	7311518202286	314	10	1	14
3853-54-1.3-3/4-W	7314150352876	314	10	1	14
3853-54-1.3-5/8	7311518197568	314	10	1	14
3853-54-1.6-2/3	7311518282899	314	10	1	14
3853-54-1.6-3/4	7311518216757	314	10	1	14
3853-54-1.6-4/6	7311518222055	314	10	1	14
3853-67-1.6-2/3	7311518282905	314	10	1	14
3853-67-1.6-3/4	7311518282912	314	10	1	14
3854-27-0.9-PHG-3/4	7311518243036	314	10	1	13
3854-27-0.9-PHG-4/6	7311518222673	314	10	1	13
3854-27-0.9-PQ-3/4	7314150137480	314	10	1	13
3854-27-0.9-PQ-4/6	7314150197828	314	10	1	13
3854-34-1.1-PHG-1.4/2	7311518287283	314	10	1	13
3854-34-1.1-PHG-2/3	7311518243043	314	10	1	13
3854-34-1.1-PHG-3/4	7311518243050	314	10	1	13
3854-34-1.1-PHG-4/6	7311518222598	314	10	1	13
3854-34-1.1-PQ-2/3	7311518287276	314	10	1	13
3854-34-1.1-PQ-3/4	7314150135813	314	10	1	13
3854-34-1.1-PQ-4/6	7314150197835	314	10	1	13
3854-41-1.3-PHG-1.4/2	7311518243067	314	10	1	13
3854-41-1.3-PHG-2/3	7311518243074	314	10	1	13
3854-41-1.3-PHG-3/4	7311518243081	314	10	1	13
3854-41-1.3-PHG-4/6	7311518331139	314	10	1	13
3854-41-1.3-PQ-1.4/2	7314150129355	314	10	1	13
3854-41-1.3-PQ-2/3	7311518280604	314	10	1	13
3854-41-1.3-PQ-3/4	7311518282950	314	10	1	13
3854-41-1.3-PQ-4/6	7314150197842	314	10	1	13
3854-54-1.3-PHG-1.4/2	7311518264246	314	10	1	13
3854-54-1.6-PHG-7/1	7311518243654	314	10	1	13
3854-54-1.6-PHG-1.4/2	7311518243098	314	10	1	13
3854-54-1.6-PHG-2/3	7311518243104	314	10	1	13
3854-54-1.6-PQ-9/1.2	7314150133857	314	10	1	13
3854-54-1.6-PQ-1.4/2	7314150127092	314	10	1	13
3854-54-1.6-PQ-2/3	7311518265137	314	10	1	13
3854-54-1.6-PQ-3/4	7311518282929	314	10	1	13
3854-54-1.6-PQ-4/6	7311518330637	314	10	1	13
3854-67-1.6-PHG-7/1	7311518243678	314	10	1	13
3854-67-1.6-PHG-1.4/2	7311518249052	314	10	1	13
3854-67-1.6-PHG-1/1.4	7311518249045	314	10	1	13
3854-67-1.6-PHG-2/3	7311518249069	314	10	1	13
3854-67-1.6-PQ-9/1.2	7314150133888	314	10	1	13
3854-67-1.6-PQ-1.4/2	7314150133901	314	10	1	13
3854-67-1.6-PQ-2/3	7311518290160	314	10	1	13
3854-67-1.6-PQ-3/4	7311518330644	314	10	1	13
3854-80-1.6-PHG-7/1	7311518329310	314	10	1	13
3854-80-1.6-PHG-1.4/2	7311518329754	314	10	1	13
3854-80-1.6-PQ-9/1.2	7314150133895	314	10	1	13
3854-80-1.6-PQ-1.4/2	7314150215966	314	10	1	13
3854-80-1.6-PQ-2/3	7314150215973	314	10	1	13
3854-80-1.6-PQ-3/4	7311518330651	314	10	1	13
3857-13-0.6-EZ-S	7311518331849	314	10	1	12
3857-13-0.6-EZ-L	7311518264789	314	10	1	12
3857-13-0.6-EZ-M	7311518264772	314	10	1	12
3857-13-0.6-EZ-M-3P1140	7314150321100	314	10	1	143
3857-13-0.6-EZ-M-3P690	7314150325641	314	10	1	143
3857-13-0.6-EZ-M-3P730	7314150325658	314	10	1	143
3857-13-0.6-EZ-M-3P835	7314150325665	314	10	1	143
3857-13-0.6-EZ-M-3P900	7314150321094	314	10	1	143
3857-13-0.6-EZ-S	7311518264765	314	10	1	12
3857-13-0.9-EZ-S	7314150181445	314	10	1	12
3857-20-0.9-EZ-L	7311518264819	314	10	1	12
3857-20-0.9-EZ-M	7311518264802	314	10	1	12
3857-20-0.9-EZ-S	7311518264796	314	10	1	12
3857-27-0.9-EZ-L	7311518264840	314	10	1	12
3857-27-0.9-EZ-M	7311518264833	314	10	1	12
3857-27-0.9-EZ-S	7311518264826	314	10	1	12
3857-34-1.1-EZ-L	7311518264871	314	10	1	12
3857-34-1.1-EZ-M	7311518264864	314	10	1	12
3857-34-1.1-EZ-S	7311518264857	314	10	1	12
3858-41-1.3-PHG-1.4/2	7314150275793	314	10	1	14
3858-41-1.3-PHG-2/3	7314150275809	314	10	1	14
3858-41-1.3-PHG-3/4	7314150275816	314	10	1	14
3858-54-1.3-PHG-2/3	7314150312849	314	10	1	14
3858-54-1.3-PHG-3/4	7314150312856	314	10	1	14
3858-54-1.6-PHG-7/1	7314150275823	314	10	1	14
3858-54-1.6-PHG-1.4/2	7314150275830	314	10	1	14
3858-54-1.6-PHG-2/3	7314150275847	314	10	1	14
3858-67-1.6-PHG-7/1	7314150312863	314	10	1	14



CUENTA SUBGRUPO



3858-67-1.6-PHG-1.4/2	7314150312870	314	10	1	14
3858-67-1.6-PHG-1/1.4	7314150312887	314	10	1	14
3858-80-1.6-PHG-7/1	7314150329946	314	10	1	14
3858-80-1.6-PHG-1.4/2	7314150312894	314	10	1	14
386-6T	7311518152017	330	20	4	564
3860-27-0.9-TCA-3	7311518330750	314	15	1	15
3860-27-0.9-TCD-3	7314150413010	314	15	1	15
3860-27-0.9-TCD-3/4	7314150413027	314	15	1	15
3860-27-0.9-TCZ-3/4	7314150263493	314	15	1	17
3860-34-1.1-TCA-2	7311518330767	314	15	1	15
3860-34-1.1-TCA-2/3	7311518330781	314	15	1	15
3860-34-1.1-TCA-3	7311518330774	314	15	1	15
3860-34-1.1-TCD-2/3	7314150413034	314	15	1	15
3860-34-1.1-TCD-3/4	7314150413041	314	15	1	15
3860-34-1.1-TCD-3/4-W	7314150413058	314	15	1	15
3860-34-1.1-TCZ-2/3	7311518330880	314	15	1	17
3860-34-1.1-TCZ-3/4	7311518330897	314	15	1	17
3860-41-1.3-TCA-1.4/2	7311518330620	314	15	1	15
3860-41-1.3-TCA-2/3	7311518330675	314	15	1	15
3860-41-1.3-TCD-1.4/2	7314150413065	314	15	1	15
3860-41-1.3-TCD-1.9/2.1	7314150413072	314	15	1	15
3860-41-1.3-TCD-2/3	7314150413089	314	15	1	15
3860-41-1.3-TCD-3/4	7314150413096	314	15	1	15
3860-41-1.3-TCD-3/4WB	7314150413102	314	15	1	15
3860-41-1.3-TCZ-2/3	7311518330903	314	15	1	17
3860-41-1.3-TCZ-3/4	7311518330910	314	15	1	17
3860-41-1.3-TMC-1.4/2	7314150129379	314	15	1	16
3860-41-1.3-TMC-2/3	7311518330224	314	15	1	16
3860-54-1.3-TMC-1.4/2	7314150288748	314	15	1	16
3860-54-1.3-TMC-2/3	7311518335267	314	15	1	16
3860-54-1.6-TCA-1.4/2	7311518330798	314	15	1	15
3860-54-1.6-TCA-1/1.25	7311518330934	314	15	1	15
3860-54-1.6-TCD-1.4/2	7314150413119	314	15	1	15
3860-54-1.6-TCD-1.4/2WB	7314150413126	314	15	1	15
3860-54-1.6-TCD-1.9/2.1	7314150413133	314	15	1	15
3860-54-1.6-TCD-2/3	7314150413140	314	15	1	15
3860-54-1.6-TCD-3/4	7314150413157	314	15	1	15
3860-54-1.6-TMC-7/1	7314150263431	314	15	1	16
3860-54-1.6-TMC-1.4/2	7314150137978	314	15	1	16
3860-54-1.6-TMC-1/1.25	7314150154340	314	15	1	16
3860-54-1.6-TMC-2/3	7314150189366	314	15	1	16
3860-67-1.6-TMC-1.4/2	7314150137985	314	15	1	16
3860-67-1.6-TMC-1/1.25	7314150154364	314	15	1	16
3860-67-1.6-TMC-2/3	7314150189359	314	15	1	16
3860-80-1.6-TMC-7/1	7314150154371	314	15	1	16
3860-80-1.6-TMC-1.4/2	7314150182992	314	15	1	16
3860-80-1.6-TMC-1/1.25	7314150182336	314	15	1	16
3860-80-1.6-TMC-2/3	7314150215959	314	15	1	16
3862-33-0.9-H-1.15	7314150320325	314	12	1	18
3862-33-1.1-H-1.15	7311518331269	314	12	1	18
3862-40-1.1-H-1.15	7311518331283	314	12	1	18
3868-27-0.9-TSX-3/4	7311518329693	314	15	1	15
3868-34-1.1-TSS-2/3	7311518329266	314	15	1	15
3868-34-1.1-TSX-2/3	7311518255343	314	15	1	15
3868-34-1.1-TSX-3/4	7311518232375	314	15	1	15
3868-41-1.3-TSS-1.4/2	7311518243142	314	15	1	15
3868-41-1.3-TSS-2/3	7311518270643	314	15	1	15
3868-41-1.3-TSX-1.4/2	7311518214210	314	15	1	15
3868-41-1.3-TSX-1.6	7311518203092	314	15	1	15
3868-41-1.3-TSX-2/3	7311518232382	314	15	1	15
3868-41-1.3-TSX-3/4	7311518232399	314	15	1	15
3868-54-1.3-TSX-1.4/2	7311518214876	314	15	1	15
3868-54-1.6-TSS-1.4/2	7311518243166	314	15	1	15
3868-54-1.6-TSS-1/1.25	7311518243173	314	15	1	15
3868-54-1.6-TSS-2/3	7311518280383	314	15	1	15
386					



CUENTA SUBGRUPO



3870-BRUSH-80-8	7311518269890	314	10	4	18
3870-REFRACTOMETER	7311518192129	314	10	1	18
3870-TACHO METER	7311518145620	314	10	1	18
3870-TENSION METER	7311518145637	314	10	1	18
3870-WEDGE-3	7311518262747	314	10	1	19
3875-BP1	7314150187737	348	45	8	420
3875-BP2	7314150187744	348	45	8	420
3875-GLOVE	7314150353330	348	20	5	432
3875-HB10	7314150349777	348	45	1	419
3875-HB100	7314150289783	348	45	1	419
3875-HB30	7314150187720	348	45	1	419
3875-HB60	7314150187713	348	45	1	419
3875-LY1	7314150191253	348	45	8	418
3875-LY10	7314150315062	348	45	1	419
3875-LY2	7314150191260	348	45	8	418
3875-LY3	7314150191284	348	45	8	418
3875-LY4	7314150262878	348	45	8	418
3875-LY5	7314150309665	348	45	1	418
3875-LY6	7314150309696	348	45	1	418
3875-LY8	7314150309689	348	45	1	419
3875-LY9	7314150313310	348	45	1	419
3875-MHP4	7314150187805	348	45	1	420
3875-MHP6	7314150187812	348	45	1	420
3875-QL1	7314150191307	348	45	8	418
3875-QRL1	7314150194797	348	45	1	418
3875-RL1	7314150194780	348	45	1	418
3875-RL2	7314150312948	348	45	1	419
3875-SB70	7314150326839	348	45	1	419
3875-WL1	7314150191291	348	45	8	418
3881-100-1.6-THS-7/1	7311518329617	314	15	1	16
3881-34-1.1-THQ-2/3	7311518265793	314	15	1	16
3881-41-1.3-THQ-1.4/2	7314150129447	314	15	1	16
3881-41-1.3-THQ-2/3	7314150129454	314	15	1	16
3881-41-1.3-THS-1.4/2	7311518273712	314	15	1	16
3881-54-1.6-THQ-1.4/2	7314150128860	314	15	1	16
3881-54-1.6-THQ-2/3	7314150138739	314	15	1	16
3881-54-1.6-THS-1.4/2	7314150138784	314	15	1	16
3881-54-1.6-THS-1/1.25	7311518269050	314	15	1	16
3881-67-1.6-THQ-1.4/2	7314150120369	314	15	1	16
3881-67-1.6-THQ-1/1.25	7314150180097	314	15	1	16
3881-67-1.6-THQ-2/3	7311518328832	314	15	1	16
3881-67-1.6-THS-1.4/2	7314150138791	314	15	1	16
3881-67-1.6-THS-1/1.25	7311518269043	314	15	1	16
3881-67-1.6-THS-2/3	7311518328849	314	15	1	16
3881-80-1.6-THQ-7/1	7311518332938	314	15	1	16
3881-80-1.6-THQ-1.4/2	7311518328856	314	15	1	16
3881-80-1.6-THQ-1/1.25	7314150133918	314	15	1	16
3881-80-1.6-THQ-2/3	7311518328863	314	15	1	16
3881-80-1.6-THS-7/1	7311518279202	314	15	1	16
3881-80-1.6-THS-1.4/2	7314150195312	314	15	1	16
3881-80-1.6-THS-2/3	7314150215942	314	15	1	16
38A-12	7314150237944	312	25	1	304
38A-15	7314150237951	312	25	25	304
38A-21	7314150237968	312	25	1	304
38A-26	7314150237975	312	25	1	304
38C-26	7314150237982	312	25	1	305
39-24	7314151831301	312	25	1	304
3905-250-24-100	7311518299255	328	15	100	499
3905-300-14-100	7311518292201	328	15	100	499
3905-300-18-100	7311518292218	328	15	100	499
3905-300-24-100	7311518292225	328	15	100	499
3905-300-24-2P	7311518299248	328	15	10	499
3905-300-32-100	7311518292232	328	15	100	499
3906-250-18-100	7311518250997	328	15	100	500
3906-250-18-5P	7314150265534	328	15	10	500
3906-250-24-100	7311518251000	328	15	100	500
3906-250-24-5P	7314150265541	328	15	10	500
3906-250-32-100	7311518251017	328	15	100	500
3906-250-32-5P	7314150265558	328	15	10	500
3906-300-14-100	7311518233563	328	15	100	500
3906-300-14-10P	7311518233693	328	15	10	500
3906-300-14-5P	7314150265565	328	15	10	500
3906-300-18-100	7311518233570	328	15	100	500
3906-300-18-10P	7311518233723	328	15	10	500
3906-300-18-2P	7311518233617	328	15	10	500
3906-300-18-5P	7314150265572	328	15	10	500
3906-300-24-100	7311518233587	328	15	100	500
3906-300-24-10P	7311518233730	328	15	10	500
3906-300-24-2P	7311518233624	328	15	10	500
3906-300-24-5P	7311518237417	328	15	10	500
3906-300-32-100	7311518233594	328	15	100	500
3906-300-32-10P	7311518233747	328	15	10	500
3906-300-32-2P	7311518233631	328	15	10	500
3906-300-32-5P	7311518237424	328	15	10	500
3906-300-3P	7311518233754	328	15	10	500
3940-100-14-SC-2P	7314150364466	346	35	5	141
3940-100-14-SC-5P	7314150364473	346	35	5	141
3940-100-14-ST-10P	7314150364336	346	35	1	141
3940-100-14-ST-2P	7314150364312	346	35	5	141
3940-100-14-ST-5P	7314150364329	346	35	5	141
3940-100-18-SC-2P	7314150364442	346	35	5	141
3940-100-18-SC-5P	7314150364459	346	35	5	141
3940-100-18-ST-10P	7314150364367	346	35	1	141
3940-100-18-ST-2P	7314150364343	346	35	5	141
3940-100-18-ST-5P	7314150364350	346	35	5	141
3940-100-24-SC-2P	7314150364558	346	35	5	141
3940-100-24-SC-5P	7314150364565	346	35	5	141
3940-100-24-ST-10P	7314150364435	346	35	1	141



CUENTA SUBGRUPO



3940-100-24-ST-2P	7314150364411	346	35	5	141
3940-100-24-ST-5P	7314150364428	346	35	5	141
3940-150-10-HST-10P	7314150364039	346	35	1	141
3940-150-10-HST-2P	7314150364015	346	35	5	141
3940-150-10-HST-5P	7314150364022	346	35	5	141
3940-150-10-ST-100P	7314150362196	346	35	1	141
3940-150-10-ST-10P	7314150362189	346	35	1	141
3940-150-10-ST-2P	7314150362165	346	35	5	141
3940-150-10-ST-5P	7314150362172	346	35	5	141
3940-150-14-HST-10P	7314150362370	346	35	1	141
3940-150-14-HST-2P	7314150362325	346	35	5	141
3940-150-14-HST-5P	7314150362363	346	35	5	141
3940-150-14-ST-100P	7314150364183	346	35	1	141
3940-150-14-ST-10P	7314150364176	346	35	1	141
3940-150-14-ST-2P	7314150364152	346	35	5	141
3940-150-14-ST-5P	7314150364169	346	35	5	141
3940-150-18-HST-10P	7314150364060	346	35	1	141
3940-150-18-HST-2P	7314150364046	346	35	5	141
3940-150-18-HST-5P	7314150364053	346	35	5	141
3940-150-18-ST-100P	7314150364107	346	35	1	141
3940-150-18-ST-10P	7314150364091	346	35	1	141
3940-150-18-ST-2P	7314150364077	346	35	5	141
3940-150-18-ST-5P	7314150364084	346	35	5	141
3940-150-24-ST-100P	7314150364404	346	35	1	141
3940-150-24-ST-10P	7314150364398	346	35	1	141
3940-150-24-ST-2P	7314150364374	346	35	5	141
3940-150-24-ST-5P	7314150364381	346	35	5	141
3940-150-4/6-SC-10P	7314150361847	346	35	1	141
3940-150-4/6-SC-2P	7314150361823	346	35	5	141
3940-150-4/6-SC-5P	7314150361830	346	35	5	141
3940-150-5/8-DSL-10P	7314150361991	346	35	1	142
3940-150-5/8-DSL-2P	7314150361977	346	35	5	142
3940-150-5/8-DSL-5P	7314150361984	346	35	5	142
3940-150-5/8-SL-100P	7314150361724	346	35	1	141
3940-150-5/8-SL-10P	7314150361717	346	35	1	141
3940-150-5/8-SL-2P	7314150361687	346	35	2	141
3940-150-5/8-SL-5P	7314150361700	346	35	5	141
3940-150-6-ST-10P	7314150361786	346	35	1	141
3940-150-6-ST-2P	7314150361762	346	35	5	141
3940-150-6-ST-5P	7314150361779	346	35	5	141
3940-150-8/12-ST-100P	7314150362158	346	35	1	141
3940-150-8/12-ST-10P	7314150362141	346	35	1	141
3940-150-8/12-ST-2P	7314150362127	346	35	5	141
3940-150-8/12-ST-5P	7314150362134	346	35	5	141
3940-228-10-DSL-10P	7314150362028	346	35	1	141
3940-228-10-DSL-2P	7314150362004	346	35	5	141
3940-228-10-DSL-5P	7314150362011	346	35	5	141
3940-228-10-HST-10P	7314150362400	346	35	1	141
3940-228-10-HST-2P	7314150362387	346	35	5	141
3940-228-10-HST-5P	7314150362394	346	35	5	141
3940-228-10-ST-100P	7314150362110	346	35	1	141
3940-228-10-ST-10P	7314150362103	346	35	1	141
3940-228-10-ST-2P	7314150362080	346	35	5	141
3940-228-10-ST-5P	7314150362097	346	35	5	141
3940-228-10/14-PR09-100P	7314150361526	346	35	1	142
3940-228-10/14-PR09-10P	7314150361519	346	35	1	142
3940-228-10/14-PR13-100P	7314150361649	346	35	1	142
3940-228-14-HST-10P	7314150362226	346	35	1	141
3940-228-14-HST-2P	7314150362202	346	35	5	141
3940-228-14-HST-5P	7314150362219	346	35	5	141
3940-228-14-ST-100P	7314150364145	346	35	1	141
3940-228-14-ST-10P	7314150364138	346	35	1	141
3940-228-14-ST-2P	7314150364114	346	35	5	141
3940-228-14-ST-5P	7314150364121	346	35	5	141
3940-228-18-HST-10P	7314150362271	346	35	1	141
3940-228-18-HST-2P	7314150362233	346	35	5	141
3940-228-18-HST-5P	7314150362264	346	35	5	141
3940-228-18-ST-100P					

3940-300-18-ST-10P



CUENTA SUBGRUPO



3940-300-18-ST-10P	7314150364299	346	35	1	141
3940-300-18-ST-2P	7314150364275	346	35	5	141
3940-300-18-ST-5P	7314150364282	346	35	5	141
3940-300-5/8-DSL-10P	7314150361960	346	35	1	142
3940-300-5/8-DSL-2P	7314150361946	346	35	5	142
3940-300-5/8-DSL-5P	7314150361953	346	35	5	142
3940-300-6-SL-10P	7314150361816	346	35	1	141
3940-300-6-SL-2P	7314150361793	346	35	5	141
3940-300-6-SL-5P	7314150361809	346	35	5	141
3940-300-8/12-SL-100P	7314150361908	346	35	1	141
3940-300-8/12-SL-10P	7314150361892	346	35	1	141
3940-300-8/12-SL-2P	7314150361878	346	35	5	141
3940-300-8/12-SL-5P	7314150361885	346	35	5	141
3940-HDD-SET-5P	7314150401703	346	35	5	139
3940-METAL-SET-5P	7314150401673	346	35	5	139
3940-MIX-SET-10P	7314150401666	346	35	4	140
3940-MIX-SET-5P	7314150401659	346	35	5	140
3942-150-7-SL-10P	7314150364534	346	35	1	141
3942-150-7-SL-2P	7314150364510	346	35	5	140
3942-150-7-SL-5P	7314150364527	346	35	5	140
3942-228-11-HSL-10P	7314150364831	346	35	1	140
3942-228-11-HSL-2P	7314150364817	346	35	5	140
3942-228-11-HSL-5P	7314150364824	346	35	5	140
3942-228-5-HSL-10P	7314150364657	346	35	1	140
3942-228-5-HSL-2P	7314150364633	346	35	5	140
3942-228-5-HSL-5P	7314150364640	346	35	5	140
3942-228-7-HSL-10P	7314150364749	346	35	1	140
3942-228-7-HSL-2P	7314150364725	346	35	5	140
3942-228-7-HSL-5P	7314150364732	346	35	5	140
3942-228-7-SL-10P	7314150364503	346	35	1	141
3942-228-7-SL-2P	7314150364480	346	35	5	141
3942-228-7-SL-5P	7314150364497	346	35	5	141
3942-300-5-HSL-10P	7314150364688	346	35	1	140
3942-300-5-HSL-2P	7314150364664	346	35	5	140
3942-300-5-HSL-5P	7314150364671	346	35	5	140
3942-300-7-HSL-10P	7314150364770	346	35	1	140
3942-300-7-HSL-2P	7314150364756	346	35	5	140
3942-300-7-HSL-5P	7314150364763	346	35	5	140
3942-300-7-SL-10P	7314150364619	346	35	1	141
3942-300-7-SL-2P	7314150364596	346	35	5	141
3942-300-7-SL-5P	7314150364602	346	35	5	141
3942-WOOD-SET-5P	7314150401680	346	35	5	140
3944-300-3-MEAT-1P	7314150364862	346	35	5	140
3946-100-G-ST-2P	7314150364930	346	35	5	140
3946-150-6-SL-1P	7314150364916	346	35	5	140
3946-150-G-ST-2P	7314150364947	346	35	5	140
3946-228-3-ST-1P	7314150364886	346	35	5	140
3946-300-3-ST-1P	7314150364879	346	35	5	140
3946-300-6-ST-1P	7314150364923	346	35	5	140
396-BLADE	7311518299057	330	20	100	569
396-HP	7311518152284	330	20	4	569
396-HP-BLADE	7311518156404	330	20	1	570
396-JS	7311518223250	330	20	4	569
396-JS-BLADE	7311518223267	330	20	1	569
396-JT	7311518168056	330	20	4	569
396-JT-BLADE	7311518168063	330	20	1	570
396-LAP	7311518172367	330	20	10	569
4-138-06-1-0	7311518020927	324	45	10	30
4-138-06-1-2	7311518000592	324	45	5	30
4-138-08-1-0	7311518020934	324	45	10	30
4-138-08-1-2	7311518000615	324	45	5	30
4-138-10-1-0	7311518020958	324	45	10	30
4-138-10-1-2	7311518000646	324	45	5	30
4-138-12-1-0	7311518020965	324	45	5	30
4-138-12-1-2	7311518194734	324	45	5	30
4-140-06-1-0	7311518020989	324	45	10	30
4-140-08-1-0	7311518020996	324	45	5	30
4-140-08-1-2	7311518028169	324	45	5	30
4-140-10-1-0	7311518022488	324	45	10	30
4-140-10-1-2	7311518194741	324	45	5	30
4-142-06-1-0	7311518021016	324	45	10	30
4-142-08-1-0	7311518021023	324	45	10	30
4-142-10-1-0	7311518021030	324	45	10	30
4-144-08-2-0	7311518021054	324	45	10	30
4-144-08-2-2	7311518201319	324	45	5	30
4-152-08-2-2	7311518000691	324	45	5	30
4-153-08-1-2	7311518000707	324	45	5	30
4-154-08-2-2	7311518000714	324	45	10	30
4-155-08-2-0	7311518116194	324	45	10	30
4-155-10-2-0	7311518116200	324	45	5	30
4-183-04-2-0	7311518021108	324	45	10	31
4-183-04-2-2	7311518201401	324	45	5	31
4-183-05-2-0	7311518021122	324	45	10	31
4-183-05-2-2	7311518201418	324	45	5	31
4-183-06-2-0	7311518021139	324	45	10	31
4-183-06-2-2	7311518000769	324	45	5	31
4-183-07-2-0	7311518021146	324	45	10	31
4-183-07-2-2	7311518194710	324	45	5	31
4-183-08-2-0	7311518021153	324	45	10	31
4-183-08-2-2	7311518194727	324	45	5	31
4-183-10-2-0	7311518021160	324	45	10	31
4-183-45-2-0	7311518021115	324	45	10	31
4-186-04-2-0	7311518021191	324	45	5	31
4-186-04-2-2	7311518201425	324	45	10	31
4-186-05-2-0	7311518021214	324	45	10	31
4-186-05-2-2	7311518028213	324	45	5	31
4-186-06-2-0	7311518021221	324	45	10	31
4-186-06-2-2	7311518000837	324	45	5	31



CUENTA SUBGRUPO



4-186-07-2-0	7311518021238	324	45	10	31
4-186-08-2-0	7311518021245	324	45	10	31
4-186-45-2-0	7311518021207	324	45	10	31
4-187-04-2-0	7311518021269	324	45	10	31
4-187-05-2-0	7311518021283	324	45	10	31
4-187-05-2-2	7311518201449	324	45	5	31
4-187-06-2-0	7311518021290	324	45	10	31
4-187-06-2-2	7311518022464	324	45	5	31
4-187-07-2-0	7311518021306	324	45	10	31
4-187-45-2-0	7311518021276	324	45	10	31
4-188-05-2-0	7311518021337	324	45	10	31
4-188-05-2-2	7311518201456	324	45	5	31
4-188-06-2-0	7311518021344	324	45	10	31
4-190-06-2-0	7311518021368	324	45	10	31
4-190-06-2-2	7311518000899	324	45	5	32
4-190-07-2-0	7311518021375	324	45	10	31
4-190-07-2-2	7311518000905	324	45	5	32
4-190-08-2-0	7311518021382	324	45	10	31
4-190-08-2-2	7311518000912	324	45	5	32
4-192-06-2-0	7311518021412	324	45	10	32
4-192-06-2-2	7311518201463	324	45	5	32
4-192-07-2-0	7311518021429	324	45	10	32
4-192-08-2-0	7311518021436	324	45	10	32
4-192-08-2-2	7311518201487	324	45	5	32
4-202-85-2-0	7311518021474	324	45	10	32
4-203-85-2-0	7311518021481	324	45	10	32
4-204-85-2-0	7311518021498	324	45	10	32
4-272-05-3-2	7311518201500	324	45	5	32
4-272-06-3-0	7311518021597	324	45	10	32
4-272-06-3-2	7311518001025	324	45	5	32
400.002.050	7314150249848	338	20	1	547
400.003.020	8412814403205	338	20	1	546
400.003.030	8412814403304	338	20	1	546
401-16	7314150400270	338	15	12	247
401-28	7314150384082	338	15	12	247
402-35	7314150384099	338	15	6	247
402-76	7314150384105	338	15	6	247
402-95-SET	7314150400997	338	15	1	248
4020L-M-3	7314151077693	366	10	5	43
4020L-M-3.2	7314151405038	366	10	5	43
4020L-M-3.5	7314151077709	366	10	5	43
4020L-M-4	7314151077716	366	10	5	43
4020L-M-4.5	7314151077723	366	10	5	43
4020L-M-5	7314151077730	366	10	5	43
4020L-M-5.5	7314151077747	366	10	5	43
4040M-10-11	7314151078287	366	15	1	60
4040M-10-13	7314153000750	366	15	1	60
4040M-12-13	7314151078294	366	15	1	60
4040M-13-17	7314151804565	366	15	1	60
4040M-14-15	7314151078300	366	15	1	60
4040M-16-17	7314151078317	366	15	1	60
4040M-16-18	7314151839635	366	15	1	60
4040M-17-19	7314151804572	366	15	1	60
4040M-18-19	7314151078324	366	15	1	60
4040M-20-22	7314151078331	366	15	1	60
4040M-21-23	7314151078348	366	15	1	60
4040M-24-27	7314151831974	366	15	1	60
4040M-6-7	7314151831967	366	15	1	60
4040M-8-9	7314151078270	366	15	1	60
4040M/6T	7314150112197	366	15	1	60
4040M/S6	7314150112180	366	15	1	60
4040Z-1/2-9/16	7314151831998	366	15	1	60
4040Z-13/16-7/8	7314150355099	366	15	1	60
4040Z-3/8-7/16	7314151831981	366	15	1	60
4040Z-5/8-11/16	7314151832001	366	15	1	60
4040Z-5/8-3/4	7314153001023	366	15	1	60
406-300	7314150183678	336	15	1	484
406-400	7314150183685	336	15	5	484
406-500	7314150183692	336	15	5	484
406-600	7314150245819	336	15	5	484
406-800	7314150245826	336	15	5	484
406P-400	7314150302574	336	15	10	484
406P-600	7314150302581	336	15	10	484
406T-225	7314150315130	336	15	10	485
407-1000	7314150369928	358	10	6	53



CUENTA SUBGRUPO



411-35	7314150412082	338	15	4	247
411-35-95	7314150412266	338	15	50	247
411-42	7314150412112	338	15	6	247
411-42-95	7314150412273	338	15	50	247
411-63	7314150412136	338	15	5	247
411-63-95	7314150412280	338	15	30	247
412-26-MULTI	7314150412174	338	15	5	247
412-26-MULTI-95	7314150412303	338	15	150	248
412-28-PEX	7314150412150	338	15	5	247
412-28-PEX-95	7314150412297	338	15	30	248
4124-JT-H	7311518267803	330	20	4	569
4128-JT-H	7311518267810	330	20	4	569
4130	7314150100019	340	10	3	211
413005000	8413345011860	358	10	6	535
413010000	8413345011877	358	10	6	535
413015000	8413345011884	358	10	6	535
413020000	8413345011891	358	10	6	535
413030000	8413345119986	358	10	1	535
413040000	8413345119993	358	10	1	535
4131	7314150100026	340	10	3	211
414-10	7311518238148	364	20	4	512
414-12	7311518238155	364	20	4	512
414-14	7311518238162	364	20	4	512
414-15	7311518238179	364	20	4	512
414-16	7311518238186	364	20	4	512
414-18	7311518238193	364	20	4	512
414-20	7311518238209	364	20	4	512
414-22	7311518238216	364	20	4	512
414-25	7311518238223	364	20	4	512
414-28	7311518238230	364	20	4	512
414-30	7311518238247	364	20	4	512
414-32	7311518238254	364	20	4	512
414-35	7311518238261	364	20	4	512
414-38	7311518238278	364	20	4	512
414-6	7311518238117	364	20	4	512
414-8	7311518238131	364	20	4	512
414-S3-EUR	7311518249205	364	20	1	512
416-1000	7314150314027	336	15	10	484
416-1200	7314150308798	336	15	10	484
416-1500	7314150314034	336	15	10	484
416-1800	7314150308804	336	15	10	484
416-2000	7314150308811	336	15	10	484
416-400	7314150314003	336	15	10	484
416-600	7314150308781	336	15	10	484
416-800	7314150314010	336	15	10	484
416-SET+BAG	7314150365470	336	15	1	485
416-SET-1	7314150308828	336	15	5	484
416-SET-2	7314150308835	336	15	5	485
41RM-10	7314153014429	366	25	1	46
41RM-11	7314153014436	366	25	1	46
41RM-12	7314153014443	366	25	1	46
41RM-13	7314153014450	366	25	1	46
41RM-14	7314153014467	366	25	1	46
41RM-17	7314153014474	366	25	1	46
41RM-19	7314153014481	366	25	1	46
41RM-21	7314150219742	366	25	1	46
41RM-8	7314153014412	366	25	1	46
41RM/SH8	7314150220656	366	25	10	47
41RZ-1/2	7314150359011	366	25	1	46
41RZ-11/16	7314150359042	366	25	1	46
41RZ-13/16	7314150359066	366	25	1	46
41RZ-3/4	7314150359059	366	25	1	46
41RZ-3/8	7314150358991	366	25	1	46
41RZ-5/16	7314150358984	366	25	1	46
41RZ-5/8	7314150359035	366	25	1	46
41RZ-7/16	7314150359004	366	25	1	46
41RZ-7/8	7314150359073	366	25	1	46
41RZ-9/16	7314150359028	366	25	1	46
420SC-25	7314150169825	318	10	10	527
420SC-50	7314150169832	318	10	5	527
420SH-100-200	7314150359691	318	10	10	526
420SH-120-1000	7314150359790	318	10	6	526
420SH-120-1250	7314150359806	318	10	6	526
420SH-120-1500	7314150359813	318	10	6	526
420SH-120-250	7314150359707	318	10	8	526
420SH-120-300	7314150359745	318	10	8	526
420SH-120-400	7314150359752	318	10	6	526
420SH-120-500	7314150359769	318	10	6	526
420SH-120-600	7314150359776	318	10	6	526
420SH-120-800	7314150359783	318	10	6	526
420SH-140-400	7314150359820	318	10	6	526
420SH-175-400	7314150359837	318	10	6	526
420SH-50-100	7314150359646	318	10	10	526
420SH-50-200	7314150359653	318	10	10	526
420SH-60-120	7314150359660	318	10	12	526
420SH-60-300	7314150359677	318	10	12	526
420SH-80-160	7314150359684	318	10	12	526
4211-11-6T	7311518152000	330	20	4	569
4211-14-6T	7311518128883	330	20	4	569
4212-11-6T	7311518002060	330	20	4	569
4212-14-6T	7311518002077	330	20	4	569
422P-10	7311518248369	364	35	4	513
422P-12	7311518248376	364	35	4	513
422P-16	7311518248383	364	35	4	513
422P-20	7311518248390	364	35	4	513
422P-25	7311518248406	364	35	4	513
422P-6	7311518248352	364	35	4	513
4231	7314150100033	340	10	3	213



CUENTA SUBGRUPO



4239	7314150100088	340	10	3	213
424P-10	7311518238315	364	15	4	510
424P-12	7311518238322	364	15	4	510
424P-14	7311518238339	364	15	4	510
424P-15	7311518238346	364	15	4	510
424P-16	7311518238353	364	15	4	510
424P-18	7311518238360	364	15	4	510
424P-20	7311518238377	364	15	4	510
424P-22	7311518238384	364	15	4	510
424P-24	7311518238391	364	15	4	510
424P-25	7311518238407	364	15	4	511
424P-26	7311518238414	364	15	4	511
424P-28	7311518238421	364	15	4	511
424P-30	7311518238438	364	15	4	511
424P-32	7311518238445	364	15	4	511
424P-35	7311518238452	364	15	4	511
424P-38	7311518238469	364	15	4	511
424P-4	7311518238285	364	15	4	510
424P-40	7311518238476	364	15	4	511
424P-6	7311518238292	364	15	4	510
424P-8	7311518238308	364	15	4	510
424P-S3-EUR	7311518249199	364	15	1	511
424P-S6-EUR	7311518269968	364	15	1	511
424P-S6-GER	7311518280086	364	15	1	511
424P-S6-LR	7314150423804	364	15	1	511
424P-S6-PP	7314150326662	364	15	1	511
424P-S8-EUR	7311518276393	364	15	1	511
425-081	7311518010669	364	25	1	512
425-082	7311518010676	364	25	1	512
425-083	7311518010683	364	25	1	513
425-10	7311518004613	364	25	4	512
425-12	7311518004620	364	25	4	512
425-14	7311518004637	364	25	4	512
425-15	7311518017767	364	25	4	512
425-16	7311518004644	364	25	4	512
425-18	7311518004651	364	25	4	512
425-20	7311518004668	364	25	4	512
425-22	7311518004675	364	25	4	512
425-24	7311518005993	364	25	4	512
425-25	7311518004682	364	25	4	512
425-26	7311518006006	364	25	4	512
425-28	7311518004699	364	25	4	512
425-30	7311518004705	364	25	4	512
425-32	7311518004712	364	25	4	512
425-35	7311518017774	364	25	4	512
425-38	7311518004729	364	25	4	512
425-4	7311518030810	364	25	4	512
425-40	7311518017781	364	25	4	512
425-6	7311518004590	364	25	4	512
425-8	7311518004606	364	25	4	512
4250A0030	8413345033633	320	10	1	552
4250M0020	8413345079365	320	10	1	552
4250M0030	8413345033626	320	10	6	552
4250MM000	8413345033909	320	10	6	552
426-1000	7311518004309	336	15	1	484
426-1200	7311518004316	336	15	1	484
426-400	7311518004255	336	15	1	484
426-600	7311518004279	336	15	1	484
426-800	7311518004293	336	15	1	484
426TOR9	7314150125319	336	15	10	485
427-16	7311518025410	358	10	4	530
427-20	7311518025427	358	10	4	530
427-700	7314150338092	358	10	6	530
428-13	7311518012243	358	10	4	530
428-16	7311518012380	358	10	4	530
428-20	7311518012397	358	10	4	530
428-700	7314150338108	358	10	6	530
429-13	7311518012250	358	10	4	530
429-16	7311518012403	358	10	4	530
429-20	7311518012410	358	10	4	530
429-8	7311518040703	358	10	4	530
42RM/S12	7314150384785	312	25	1	47
430002600	8413345036016	320	10	1	552
4307	7314151079444	366	30	1	61
4310	7314151079451	366	30	1	61
434-10	7311518238506	364	10	4	510
434-12	7311518238513	364	10	4	510
434-14	7311518238520	364	10	4	510
434-15	7311518238537	364	10	4	510
434-16	7311518238544	364	10	4	510
434-18	7311518238551	364	10	4	510
434-20	7311518238568	364	10	4	510
434-22	7311518238575	364	10	4	510
434-25	7311518238582	364	10	4	510
434-28	7311518238599	364	10	4	510
434-30	7311518238605	364	10	4	510
434-32	7311518238612	364	10	4	510
434-35	7311518238629	364	10	4	510



CUENTA SUBGRUPO



439000001	7314150268788	348	45	1	418
439000002	7314150309702	348	45	1	419
439000003	7314150309719	348	45	1	419
4400-11	7311518200596	330	20	10	570
4400-11-BULK	7311518200633	330	20	10	570
4400-14	7311518200602	330	20	10	570
4400-14-BULK	7311518200640	330	20	10	570
440102500	8413345098977	358	20	10	532
440103000	8413345098991	358	20	10	532
4411-1.00	7314150372744	346	20	1	150
4411-1.50	7314150372768	346	20	1	150
4411-10.00	7314150372973	346	20	1	150
4411-10.20	7314150372980	346	20	1	150
4411-11.00	7314150372997	346	20	1	150
4411-12.00	7314150373000	346	20	1	150
4411-13.00	7314150373017	346	20	1	150
4411-2.00	7314150372775	346	20	1	150
4411-2.50	7314150372782	346	20	1	150
4411-3.00	7314150372799	346	20	1	150
4411-3.25	7314150372805	346	20	1	150
4411-3.30	7314150372812	346	20	1	150
4411-3.50	7314150372829	346	20	1	150
4411-4.00	7314150372836	346	20	1	150
4411-4.20	7314150372843	346	20	1	150
4411-4.25	7314150372850	346	20	1	150
4411-4.50	7314150372867	346	20	1	150
4411-5.00	7314150372874	346	20	1	150
4411-5.50	7314150372881	346	20	1	150
4411-6.00	7314150372898	346	20	1	150
4411-6.50	7314150372904	346	20	1	150
4411-6.80	7314150372911	346	20	1	150
4411-7.00	7314150372928	346	20	1	150
4411-7.50	7314150372935	346	20	1	150
4411-8.00	7314150372942	346	20	1	150
4411-8.50	7314150372959	346	20	1	150
4411-9.00	7314150372966	346	20	1	150
4411-9.50	7314150394463	346	20	1	150
4413-1.00	7314150371754	346	20	1	151
4413-1.50	7314150371761	346	20	1	151
4413-10.00	7314150372034	346	20	1	151
4413-10.20	7314150372041	346	20	1	151
4413-11.00	7314150372058	346	20	1	151
4413-12.00	7314150372065	346	20	1	151
4413-13.00	7314150372072	346	20	1	151
4413-2.00	7314150371785	346	20	1	151
4413-2.50	7314150371792	346	20	1	151
4413-3.00	7314150371815	346	20	1	151
4413-3.25	7314150371822	346	20	1	151
4413-3.30	7314150371877	346	20	1	151
4413-3.50	7314150371884	346	20	1	151
4413-4.00	7314150371891	346	20	1	151
4413-4.20	7314150371907	346	20	1	151
4413-4.25	7314150371914	346	20	1	151
4413-4.50	7314150371921	346	20	1	151
4413-5.00	7314150371938	346	20	1	151
4413-5.50	7314150371945	346	20	1	151
4413-6.00	7314150371952	346	20	1	151
4413-6.50	7314150371969	346	20	1	151
4413-6.80	7314150371976	346	20	1	151
4413-7.00	7314150371983	346	20	1	151
4413-7.50	7314150371990	346	20	1	151
4413-8.00	7314150372003	346	20	1	151
4413-8.50	7314150372010	346	20	1	151
4413-9.00	7314150372027	346	20	1	151
4413-9.50	7314150394456	346	20	1	151
4415-1.00	7314150394210	346	20	1	151
4415-1.50	7314150394227	346	20	1	151
4415-10.00	7314150394401	346	20	1	151
4415-11.00	7314150394418	346	20	1	151
4415-12.00	7314150394425	346	20	1	151
4415-13.00	7314150394432	346	20	1	151
4415-2.00	7314150394234	346	20	1	151
4415-2.50	7314150394241	346	20	1	151
4415-3.00	7314150394258	346	20	1	151
4415-3.25	7314150394265	346	20	1	151
4415-3.50	7314150394272	346	20	1	151
4415-4.00	7314150394289	346	20	1	151
4415-4.25	7314150394296	346	20	1	151
4415-4.50	7314150394302	346	20	1	151
4415-5.00	7314150394319	346	20	1	151
4415-5.50	7314150394326	346	20	1	151
4415-6.00	7314150394333	346	20	1	151
4415-6.50	7314150394340	346	20	1	151
4415-7.00	7314150394357	346	20	1	151
4415-7.50	7314150394364	346	20	1	151
4415-8.00	7314150394371	346	20	1	151
4415-8.50	7314150394388	346	20	1	151
4415-9.00	7314150394395	346	20	1	151
442	7311518002848	362	10	10	490
442 B	7314150008957	338	10	1	244
442-3P	7314150309610	362	10	10	490
4420-11	7311518200619	330	20	10	570
4420-11-BULK	7311518200657	330	20	10	570
4420-14	7311518200626	330	20	10	570
4420-14-BULK	7311518200664	330	20	10	570
443 B	7314150008971	338	10	1	244
4430	7314150100040	340	10	3	223
444 B	7314150009008	338	10	1	244



CUENTA SUBGRUPO



4480/2-ZD	7311518276911	338	15	1	246
4480IM	7314150263165	338	20	1	246
4480MM	7314150263158	338	20	1	246
449	7311518005337	362	10	10	490
44Z-1/2-9/16	7314150375233	366	10	10	54
44Z-1/4-5/16	7314150375196	366	10	10	54
44Z-11/16-13/16	7314150375264	366	10	5	54
44Z-11/16-3/4	7314150375257	366	10	5	54
44Z-3/8-7/16	7314150375219	366	10	10	54
44Z-5/16-3/8	7314150375202	366	10	10	54
44Z-5/8-3/4	7314150375240	366	10	5	54
44Z-7/16-1/2	7314150375226	366	10	10	54
451	7311518014506	362	10	10	490
4511-0.50-10P	7314150373079	346	20	1	150
4511-0.75-10P	7314150373062	346	20	1	150
4511-1.00-10P	7314150373055	346	20	1	150
4511-1.50-10P	7314150373086	346	20	1	150
4511-1.75-10P	7314150373093	346	20	1	150
4511-10.00-5P	7314150373444	346	20	1	151
4511-10.20-5P	7314150373468	346	20	1	151
4511-10.30-5P	7314150373475	346	20	1	151
4511-10.50-5P	7314150373482	346	20	1	151
4511-10.80-5P	7314150373499	346	20	1	151
4511-11.00-5P	7314150373505	346	20	1	151
4511-11.50-5P	7314150373512	346	20	1	151
4511-12.00-5P	7314150373529	346	20	1	151
4511-12.50-5P	7314150373536	346	20	1	151
4511-12.80-5P	7314150373543	346	20	1	151
4511-13.00-5P	7314150373550	346	20	1	151
4511-13.50-1P	7314150373567	346	20	1	151
4511-14.00-1P	7314150373574	346	20	1	151
4511-14.50-1P	7314150373581	346	20	1	151
4511-15.00-1P	7314150373598	346	20	1	151
4511-15.50-1P	7314150373604	346	20	1	151
4511-16.00-1P	7314150373611	346	20	1	151
4511-16.50-1P	7314150373628	346	20	1	151
4511-17.00-1P	7314150373635	346	20	1	151
4511-17.50-1P	7314150373642	346	20	1	151
4511-18.00-1P	7314150373659	346	20	1	151
4511-18.50-1P	7314150373673	346	20	1	151
4511-19.00-1P	7314150373680	346	20	1	151
4511-19.50-1P	7314150373697	346	20	1	151
4511-2.00-10P	7314150373109	346	20	1	150
4511-2.50-10P	7314150373116	346	20	1	150
4511-2.70-10P	7314150373123	346	20	1	150
4511-2.90-10P	7314150373130	346	20	1	150
4511-20.00-1P	7314150373666	346	20	1	151
4511-3.00-10P	7314150373147	346	20	1	150
4511-3.10-10P	7314150373185	346	20	1	150
4511-3.25-10P	7314150373192	346	20	1	150
4511-3.30-10P	7314150373208	346	20	1	150
4511-3.50-10P	7314150373215	346	20	1	150
4511-3.80-10P	7314150373222	346	20	1	150
4511-4.00-10P	7314150373239	346	20	1	150
4511-4.20-10P	7314150373246	346	20	1	150
4511-4.50-10P	7314150373253	346	20	1	150
4511-4.80-10P	7314150373260	346	20	1	150
4511-5.00-10P	7314150373277	346	20	1	150
4511-5.20-10P	7314150373284	346	20	1	150
4511-5.50-10P	7314150373291	346	20	1	150
4511-6.00-10P	7314150373307	346	20	1	150
4511-6.20-10P	7314150373314	346	20	1	150
4511-6.50-10P	7314150373321	346	20	1	150
4511-6.80-10P	7314150373338	346	20	1	150
4511-7.00-10P	7314150373345	346	20	1	150
4511-7.20-10P	7314150373352	346	20	1	150
4511-7.50-10P	7314150373369	346	20	1	150
4511-7.80-10P	7314150373376	346	20	1	150
4511-8.00-10P	7314150373383	346	20	1	150
4511-8.50-10P	7314150373390	346	20	1	150
4511-8.60-10P	7314150373406	346	20	1	150
4511-8.80-10P	7314150373413	346	20	1	151
4511-9.00-10P	7314150373420	346	20	1	151
4511-9.20-10P	7314150373437	346	20	1	151
4511-9.50-10P	7311518339081	346	20	1	151
4511-9.60-10P	7314150373451	346	20	1	151
4511-SET-19	7314150373031	346	20	1	152
4511-SET-25	7314150373048	346	20	1	152
4511-SET-6	7314150373024	346	20	1	152
4513-1					



CUENTA SUBGRUPO



4513-16.00-1P	7314150392155	346	20	1	151
4513-16.50-1P	7314150392162	346	20	1	151
4513-17.00-1P	7314150392179	346	20	1	151
4513-17.50-1P	7314150392186	346	20	1	151
4513-18.00-1P	7314150392193	346	20	1	151
4513-18.50-1P	7314150392209	346	20	1	151
4513-19.00-1P	7314150392216	346	20	1	151
4513-19.50-1P	7314150392223	346	20	1	151
4513-2.00-10P	7314150372140	346	20	1	151
4513-2.50-10P	7314150372157	346	20	1	151
4513-2.70-10P	7314150372164	346	20	1	151
4513-2.90-10P	7314150372171	346	20	1	151
4513-20.00-1P	7314150392230	346	20	1	151
4513-3.00-10P	7314150372188	346	20	1	151
4513-3.10-10P	7314150372195	346	20	1	151
4513-3.25-10P	7314150372201	346	20	1	151
4513-3.30-10P	7314150372218	346	20	1	151
4513-3.50-10P	7314150372225	346	20	1	151
4513-3.80-10P	7314150372232	346	20	1	151
4513-4.00-10P	7314150372249	346	20	1	151
4513-4.20-10P	7314150372256	346	20	1	151
4513-4.50-10P	7314150372263	346	20	1	151
4513-4.80-10P	7314150372270	346	20	1	151
4513-5.00-10P	7314150372287	346	20	1	151
4513-5.20-10P	7314150372294	346	20	1	151
4513-5.50-10P	7314150372300	346	20	1	151
4513-6.00-10P	7314150372317	346	20	1	151
4513-6.20-10P	7314150372324	346	20	1	151
4513-6.50-10P	7314150372331	346	20	1	151
4513-6.80-10P	7314150372348	346	20	1	151
4513-7.00-10P	7314150372355	346	20	1	151
4513-7.20-10P	7314150372362	346	20	1	151
4513-7.50-10P	7314150372379	346	20	1	151
4513-7.80-10P	7314150372386	346	20	1	151
4513-8.00-10P	7314150372393	346	20	1	151
4513-8.50-10P	7314150372409	346	20	1	151
4513-8.60-10P	7314150372416	346	20	1	151
4513-8.80-10P	7314150372423	346	20	1	151
4513-9.00-10P	7314150372430	346	20	1	151
4513-9.20-10P	7314150372447	346	20	1	151
4513-9.50-10P	7314150372454	346	20	1	151
4513-9.60-10P	7314150372461	346	20	1	151
4513-SET-19	7314150372096	346	20	1	152
4513-SET-25	7314150372102	346	20	1	152
4513-SET-6	7314150372089	346	20	1	152
4515-SET-19	7314150394449	346	20	1	152
4518-3	7314151716547	322	10	1	340
4518-4	7314151716622	322	10	1	340
4518-5	7314151716899	322	10	1	340
4519-1	7314151716974	322	10	1	337
4519-1/B	7314150225149	322	35	1	337
4519-1/S	7314151843762	322	35	1	337
4519-2	7314151717193	322	10	1	337
4519-2/S	7314151843977	322	35	1	337
4519-23/B	7314150225156	322	35	1	337
4519-3	7314151717278	322	10	1	337
4519K1	7314150225163	322	35	1	337
4519K2	7314150225170	322	35	1	337
4519K3	7314150225187	322	35	1	337
4521N-0	7314151837723	322	10	1	338
4521N-00	7314151837716	322	10	1	338
4521N-A	7314151837730	322	10	1	338
4521N-B	7314151837747	322	10	1	338
4521N-C	7314151837754	322	10	1	338
4521N-D	7314151837761	322	10	1	338
4521N-E	7314151837778	322	10	1	338
4521N-F	7314151837785	322	10	1	338
4521N-G	7314151837792	322	10	1	338
4521N-H	7314151837808	322	10	1	338
4521N-I	7314151837815	322	10	1	338
4521N-K	7314151837822	322	10	1	338
4521N-L	7314151837839	322	10	1	338
4521N-M	7314151837846	322	10	1	338
4521N-S	7314151839789	322	10	1	338
4521N-T	7314151839796	322	10	1	338
4521N/7	7314151839802	322	10	1	339
4522-1	7314151081591	322	10	1	339
4522-1/B	7314150225033	322	35	1	339
4522-1/S	7314150225064	322	35	1	339
4522-2	7314151081614	322	10	1	339
4522-2/B	7314150225057	322	35	1	339
4522-2/S	7314150225071	322	35	1	339
4522K1	7314150225088	322	35	1	339
4522K2	7314150225095	322	35	1	339
4523G	7314151846695	322	10	1	339
4524G	7314151718596	322	10	1	339
4528-1	7314151718671	322	10	1	336
4528-1/B	7314150224692	322	35	1	336
4528K1	7314151837662	322	35	1	336
4528K2	7314151837679	322	35	1	336
4528K3	7314151837686	322	35	1	336
4528K4	7314151837693	322	35	1	336
4528K5	7314151837709	322	35	1	336
4528M1	7314151718916	322	10	1	337
4528M1/B	7314150224654	322	35	1	337
4528M1/P	7314150330959	322	35	1	337
4528M2	7314151719050	322	10	1	337
4528M2/B	7314150224661	322	35	1	337



CUENTA SUBGRUPO



4528M2/P	7314150330980	322	35	1	337
4528M3	7314151719135	322	10	1	337
4528M3/P	7314150330973	322	35	1	337
4528M345/B	7314150224678	322	35	1	337
4528M4	7314151719210	322	10	1	337
4528M5	7314151719487	322	10	1	337
4528MK5	7314150224685	322	35	1	337
4529-15	7314151719647	322	10	1	336
4529-8	7314151719562	322	10	1	336
4530	7314150100095	340	10	3	224
4532-0	7314151719722	322	10	1	336
4532-A	7314151082109	322	10	1	336
4532-A/B	7314150224401	322	35	1	336
4532-AL	7314150221912	322	10	1	336
4532-B	7314151082116	322	10	1	336
4532-B/B	7314150224418	322	35	1	336
4532-BL	7314150221929	322	10	1	336
4532-C	7314151082123	322	10	1	336
4532-C/B	7314150224425	322	35	1	336
4532-CD/S	7314151818067	322	35	1	336
4532-CL	7314150221936	322	10	1	336
4532-D	7314151082130	322	10	1	336
4532-D/B	7314150224432	322	35	1	336
4532-E	7314151082147	322	10	1	336
4532-E/B	7314150224449	322	35	1	336
4532-EFG/S	7314151838386	322	35	1	336
4532-F	7314151082154	322	10	1	336
4532-F/B	7314150224456	322	35	1	336
4532-G	7314151082161	322	10	1	336
4532-G-SO	7314151841003	322	10	1	336
4532-G/B	7314150224463	322	35	1	336
4532-H	7314151719999	322	10	1	336
4532-H/B	7314150224470	322	35	1	336
4532-H/S	7314151838393	322	35	1	336
4532-O/B	7314150224388	322	35	1	336
4532-OAB/S	7314151818050	322	35	1	336
4532K1	7314151082185	322	35	1	336
4532K2	7314151082192	322	35	1	336
4532K3	7314151082208	322	35	1	336
4532K4	7314151720148	322	35	1	336
4532KO	7314151720063	322	35	1	336
4532LK1	7314151082215	322	35	1	336
4532LK2	7314151082222	322	35	1	336
4532LK3	7314151082239	322	35	1	336
4532LK4	7314151082246	322	35	1	336
4532LK5	7314151720223	322	35	1	336
4532ST/5	7314151720490	322	10	1	336
4533HP	7314151793043	322	10	1	336
4533HP/S	7314150224487	322	35	1	336
4533HPK	7314150224500	322	35	1	336
4533M	7314151793050	322	10	1	336
4533M/S	7314150224494	322	35	1	336
4533MK	7314150224517	322	35	1	336
4537-1	7314151720650	322	10	1	337
4537-1/B	7314150224562	322	35	1	337
4537-2	7314151720735	322	10	1	337
4537-2/B	7314150224579	322	35	1	337
4537-3	7314151720810	322	10	1	337
4537-34/B	7314150224586	322	35	1	337
4537-4	7314151721039	322	10	1	337
4537K1	7314150224593	322	35	1	337
4537K2	7314150224609	322	35	1	337
4537K3	7314150224616	322	35	1	337
4537K4	7314150224623	322	35	1	337
4540-17	7314150125005	322	10	1	338
4540-17/K1	7314150225231	322	35	1	338
4540-17/K2	7314150225224	322	35	1	338
4540-17/K3	7314150225217	322	35	1	338
4540-17/K4	7314150225200	322	35	1	338
4540-17/S	7314150225248	322	35	1	338
4540-25	7314150125012	322	10	1	338
4540-25/K1	7314150225279	322	35	1	338
4540-25/K2	7314150239238	322	35	1	338
4540-25/K3	7314150225262	322	35	1	338
4540-25/K4	7314150225255	322	35	1	338
4540-25/S	7314150225286	322	35	1	338
4541-A	7314151082413	322	10	1	337
4541-A/B	7314150224524	322	35	1	337
4541-B	7314151082420	322	10	1	337
4541-B/B	7314150224531	322	35	1	337
4541KA	7314150224548	322	35	1	337
4541KB	7314150224555	322	35	1	337
4542-A	7314151082451	322	10	1	337
4542-A/B	7314150224630	322	35	1	337
4542-B	7314151082468	322	10	1	337
4542-B/B	7314150224647	322	35	1	337

4543-30/B



CUENTA SUBGRUPO



4543-30/B	7314150224722	322	35	1	337
4543K110	7314150224746	322	35	1	337
4543K220	7314150224753	322	35	1	337
4543K330	7314150224760	322	35	1	337
4544-1	7314151844004	322	10	1	336
4544-1/B	7314150224845	322	35	1	336
4544-10	7314151844042	322	10	1	336
4544-10/B	7314150224883	322	35	1	336
4544-110/S	7314150224777	322	35	1	337
4544-2	7314151844011	322	10	1	336
4544-2/B	7314150224852	322	35	1	336
4544-20	7314151844059	322	10	1	336
4544-20/B	7314150224890	322	35	1	336
4544-220/S	7314150224784	322	35	1	337
4544-3	7314151844028	322	10	1	336
4544-3/B	7314150224869	322	35	1	336
4544-30	7314151844066	322	10	1	336
4544-30/B	7314150224906	322	35	1	336
4544-4	7314151844035	322	10	1	336
4544-4/B	7314150224876	322	35	1	336
4544-440/S	7314150224791	322	35	1	337
4544K110	7314150224807	322	35	1	336
4544K220	7314150224814	322	35	1	336
4544K330	7314150224821	322	35	1	337
4544K440	7314150224838	322	35	1	337
4545-1	7314151082543	322	10	1	340
4545-2	7314151082550	322	10	1	340
4545-3	7314151082567	322	10	1	340
4545-4	7314151722272	322	10	1	340
4545-5	7314151722357	322	10	1	340
4545-N1	7314151722432	322	10	1	339
4545-N1/S	7314150224913	322	35	1	339
4545-N11	7314150249169	322	10	1	339
4545-N2	7314151804947	322	10	1	339
4545-N2/S	7314150224920	322	35	1	339
4545-N21	7314150249176	322	10	1	339
4551-A	7314151082628	322	10	1	338
4551-A/S	7314150224937	322	35	1	338
4551-B	7314151722784	322	10	1	338
4551-B/S	7314150224944	322	35	1	338
4551-C	7314151082642	322	10	1	338
4551-C/S	7314150224951	322	35	1	338
4551-D	7314151082659	322	10	1	338
4551-D/S	7314150224968	322	35	1	338
4553	7314151830649	322	15	1	340
4559-12	7314150113132	340	15	1	217
4559-12A JC	7314150223909	340	15	1	217
4559-18	7314150024513	340	15	8	217
4559-18B JC	7314150113880	340	15	1	217
4559-24	7314150024520	340	15	6	217
4559-24B JC	7314150113897	340	15	1	217
4559-30	7314150024537	340	15	5	217
4559-30B JC	7314150113903	340	15	1	217
4559-36	7314150024544	340	15	3	217
4559-36B JC	7314150113910	340	15	1	217
4559-42	7314150024551	340	15	2	217
4559-42A JC	7314150208876	340	15	1	217
4560-210	7314150178995	340	20	1	217
4574	7314151799014	322	10	1	338
4577	7314151838348	322	10	1	339
4578	7314150222308	322	10	1	338
4579	7314150222018	322	10	1	339
4580N/7	7314151301361	322	10	1	339
4581N-1	7314151724139	322	10	1	338
4581NA	7314151301200	322	35	1	338
4581NB	7314151301217	322	35	1	338
4581NB2	7314151724726	322	35	1	338
4581NC	7314151301224	322	35	1	338
4582N-1	7314151724214	322	10	1	338
4582N-2	7314151724481	322	10	1	338
4582NA	7314151301248	322	35	1	338
4582NB	7314151301255	322	35	1	338
4583N-1	7314151724566	322	35	1	338
4583N-2	7314151724641	322	35	1	338
4583NA	7314151301279	322	35	1	338
4583NB	7314151301286	322	35	1	338
4590SHS5	7314150384822	312	25	4	339
4591	7314151804039	322	15	1	340
4592	7314151804046	322	15	1	340
4593	7314151804053	322	15	1	340
4594VWT4	7314150403639	312	25	5	304
45S/H1.5	7314150218530	346	50	1	163
45S/H1.5-2P	7314150261505	346	50	50	163
45S/H2	7314150218547	346	50	1	163
45S/H2-2P	7314150261512	346	50	50	163
45S/H2.5	7314150218554	346	50	1	163
45S/H2.5-2P	7314150261529	346	50	50	163
45S/H3	7314150218561	346	50	1	163
45S/H3-2P	7314150261536	346	50	50	163
45S/PH1	7314150218516	346	50	1	163
45S/PH1-2P	7314150261482	346	50	50	163
45S/PH2	7314150218523	346	50	1	163
45S/PH2-2P	7314150261499	346	50	50	163
4610-1	7314151724993	322	20	1	340
4611-2	7314151725372	322	20	1	340
4611-2/B	7314150237500	322	35	1	340
4611-2/S	7314150237494	322	35	1	340
4611-3	7314150125043	322	20	1	340



CUENTA SUBGRUPO



4611-3/B	7314150237524	322	35	1	340
4611-3/S	7314150237517	322	35	1	340
4614-1	7314151725457	322	10	1	337
4614-1/B	7314150225101	322	35	1	337
4614-2	7314151725532	322	10	1	337
4614-2/B	7314150225118	322	35	1	337
4614K1	7314150225125	322	35	1	337
4614K2	7314150225132	322	35	1	337
4630	7314150216154	338	20	1	547
4641-10-120	7314150383085	346	25	1	150
4641-10-200	7314150383115	346	25	1	150
4641-10-400	7314150383207	346	25	1	150
4641-10-600	7314150383221	346	25	1	150
4641-11-150	7314150383122	346	25	1	150
4641-12-150	7314150383139	346	25	1	150
4641-12-200	7314150383146	346	25	1	150
4641-12-400	7314150383238	346	25	1	150
4641-12-600	7314150383245	346	25	1	150
4641-13-150	7314150383153	346	25	1	150
4641-14-150	7314150383160	346	25	1	150
4641-14-400	7314150383252	346	25	1	150
4641-14-600	7314150383269	346	25	1	150
4641-16-150	7314150383177	346	25	1	150
4641-16-400	7314150383276	346	25	1	150
4641-16-600	7314150383283	346	25	1	150
4641-18-400	7314150383290	346	25	1	150
4641-18-600	7314150383306	346	25	1	150
4641-20-400	7314150383313	346	25	1	150
4641-20-600	7314150383320	346	25	1	150
4641-22-400	7314150383337	346	25	1	150
4641-24-400	7314150383344	346	25	1	150
4641-25-400	7314150383351	346	25	1	150
4641-3-60	7314150382859	346	25	1	150
4641-4-75	7314150382866	346	25	1	150
4641-5-5-85	7314150382897	346	25	1	150
4641-5-150	7314150382880	346	25	1	150
4641-5-85	7314150382873	346	25	1	150
4641-6-5-100	7314150383030	346	25	1	150
4641-6-100	7314150383016	346	25	1	150
4641-6-150	7314150383023	346	25	1	150
4641-6-400	7314150383184	346	25	1	150
4641-7-100	7314150383047	346	25	1	150
4641-8-120	7314150383054	346	25	1	150
4641-8-200	7314150383061	346	25	1	150
4641-8-400	7314150383191	346	25	1	150
4641-9-120	7314150383078	346	25	1	150
4641-PB	7314150383368	346	25	1	150
4651-10-1000	7314150386413	346	27	1	149
4651-10-110	7314150386345	346	27	1	149
4651-10-160	7314150386352	346	27	1	149
4651-10-210	7314150386369	346	27	1	149
4651-10-260	7314150386376	346	27	1	149
4651-10-310	7314150386383	346	27	1	149
4651-10-450	7314150386390	346	27	1	149
4651-10-600	7314150386406	346	27	1	149
4651-12-1000	7314150386581	346	27	1	149
4651-12-160	7314150386529	346	27	1	149
4651-12-210	7314150386536	346	27	1	149
4651-12-260	7314150386543	346	27	1	149
4651-12-310	7314150386550	346	27	1	149
4651-12-450	7314150386567	346	27	1	149
4651-12-600	7314150386574	346	27	1	149
4651-14-1000	7314150386659	346	27	1	149
4651-14-160	7314150386598	346	27	1	149
4651-14-210	7314150386604	346	27	1	149
4651-14-260	7314150386611	346	27	1	149
4651-14-310	7314150386628	346	27	1	149
4651-14-450	7314150386635	346	27	1	149
4651-14-600	7314150386642	346	27	1	149
4651-15-160	7314150386666	346	27	1	149
4651-15-260	7314150386673	346	27	1	149
4651-15-450	7314150386680	346	27	1	149
4651-16-1000	7314150386765	346	27	1	149
4651-16-160	7314150386697	346	27	1	149
4651-16-210	7314150386710	346	27	1	149
4651-16-260	7314150386727	346	27	1	149
4651-16-310	7314150386734	346	27	1	149
4651-16-450	7314150386741	346	27	1	149
4651-16-600	7314150386758	346	27	1	149
4651-18-250	7314150386789	346	27	1	149
4651-18-450	7314150386796	346	27	1	149
4651-20-250	7314150386802	346	27	1	149
4651-20-450	7314150386819	346	27	1	149
4651-22-250	731				



CUENTA SUBGRUPO



4651-5-260	7314150385713	346	27	1	149
4651-6-5-160	7314150385799	346	27	1	149
4651-6-5-210	7314150385805	346	27	1	149
4651-6-5-260	7314150385812	346	27	1	149
4651-6-5-310	7314150385829	346	27	1	149
4651-6-110	7314150385744	346	27	1	149
4651-6-160	7314150385751	346	27	1	149
4651-6-210	7314150385768	346	27	1	149
4651-6-260	7314150385775	346	27	1	149
4651-6-310	7314150385782	346	27	1	149
4651-7-110	7314150385836	346	27	1	149
4651-7-160	7314150386253	346	27	1	149
4651-8-110	7314150386277	346	27	1	149
4651-8-160	7314150386284	346	27	1	149
4651-8-210	7314150386291	346	27	1	149
4651-8-260	7314150386307	346	27	1	149
4651-8-310	7314150386314	346	27	1	149
4651-8-460	7314150386321	346	27	1	149
4651-9-160	7314150386338	346	27	1	149
4652-10-110	7314150385119	346	27	1	149
4652-10-160	7314150385126	346	27	1	149
4652-10-210	7314150385133	346	27	1	149
4652-10-260	7314150385140	346	27	1	149
4652-10-310	7314150385164	346	27	1	149
4652-10-450	7314150385171	346	27	1	149
4652-10-600	7314150385188	346	27	1	149
4652-11-160	7314150385195	346	27	1	149
4652-11-210	7314150385201	346	27	1	149
4652-11-260	7314150385218	346	27	1	149
4652-12-1000	7314150385287	346	27	1	149
4652-12-160	7314150385225	346	27	1	149
4652-12-210	7314150385232	346	27	1	149
4652-12-260	7314150385249	346	27	1	149
4652-12-310	7314150385256	346	27	1	149
4652-12-450	7314150385263	346	27	1	149
4652-12-600	7314150385270	346	27	1	149
4652-13-160	7314150385294	346	27	1	149
4652-13-310	7314150385300	346	27	1	149
4652-14-1000	7314150385379	346	27	1	149
4652-14-160	7314150385317	346	27	1	149
4652-14-210	7314150385324	346	27	1	149
4652-14-260	7314150385331	346	27	1	149
4652-14-310	7314150385348	346	27	1	149
4652-14-450	7314150385355	346	27	1	149
4652-14-600	7314150385362	346	27	1	149
4652-15-160	7314150385386	346	27	1	149
4652-15-260	7314150385393	346	27	1	149
4652-16-1000	7314150385478	346	27	1	149
4652-16-160	7314150385409	346	27	1	149
4652-16-210	7314150385416	346	27	1	149
4652-16-260	7314150385423	346	27	1	149
4652-16-310	7314150385430	346	27	1	149
4652-16-450	7314150385447	346	27	1	149
4652-16-600	7314150385454	346	27	1	149
4652-16-800	7314150385461	346	27	1	149
4652-18-1000	7314150385515	346	27	1	149
4652-18-200	7314150385485	346	27	1	149
4652-18-300	7314150385492	346	27	1	149
4652-18-450	7314150385508	346	27	1	149
4652-20-1000	7314150385560	346	27	1	149
4652-20-200	7314150385522	346	27	1	149
4652-20-300	7314150385539	346	27	1	149
4652-20-450	7314150385546	346	27	1	149
4652-20-600	7314150385553	346	27	1	149
4652-22-1000	7314150385607	346	27	1	149
4652-22-250	7314150385577	346	27	1	149
4652-22-450	7314150385584	346	27	1	149
4652-22-600	7314150385591	346	27	1	149
4652-24-250	7314150385614	346	27	1	149
4652-24-450	7314150385621	346	27	1	149
4652-25-1000	7314150385652	346	27	1	149
4652-25-250	7314150385638	346	27	1	149
4652-25-450	7314150385645	346	27	1	149
4652-26-250	7314150385669	346	27	1	149
4652-26-450	7314150385676	346	27	1	149
4652-4-110	7314150384365	346	27	1	149
4652-4-160	7314150384372	346	27	1	149
4652-5-5-110	7314150384853	346	27	1	149
4652-5-5-160	7314150384860	346	27	1	149
4652-5-110	7314150384815	346	27	1	149
4652-5-160	7314150384839	346	27	1	149
4652-5-210	7314150384846	346	27	1	149
4652-6-5-110	7314150384976	346	27	1	149
4652-6-5-160	7314150384990	346	27	1	149
4652-6-110	7314150384877	346	27	1	149
4652-6-160	7314150384891	346	27	1	149
4652-6-210	7314150384907	346	27	1	149
4652-6-260	7314150384969	346	27	1	149
4652-7-110	7314150385003	346	27	1	149
4652-7-160	7314150391981	346	27	1	149
4652-8-110	7314150385034	346	27	1	149
4652-8-160	7314150385058	346	27	1	149
4652-8-210	7314150385065	346	27	1	149
4652-8-260	7314150385072	346	27	1	149
4652-8-460	7314150385089	346	27	1	149
4652-9-160	7314150385096	346	27	1	149
4652-9-210	7314150385102	346	27	1	149
4655-FLAT-250	7314150387823	346	27	1	150



CUENTA SUBGRUPO



4655-HOLLOW-240	7314150387847	346	27	1	150
4655-POINT-250	7314150387816	346	27	1	150
4655-SLOT-25032	7314150387885	346	27	1	150
4655-TILE-20040	7314150387861	346	27	1	150
4655-TILE-25060	7314150387878	346	27	1	150
4655-WIDE-20040	7314150387830	346	27	1	150
4655-WING-C-250	7314150387854	346	27	1	150
4656-12-340	7314150386932	346	27	1	148
4656-12-540	7314150387021	346	27	1	148
4656-12-690	7314150387045	346	27	1	148
4656-14-340	7314150387069	346	27	1	148
4656-14-540	7314150387076	346	27	1	148
4656-15-340	7314150387083	346	27	1	148
4656-15-540	7314150387090	346	27	1	148
4656-16-1320	7314150387137	346	27	1	148
4656-16-340	7314150387106	346	27	1	148
4656-16-540	7314150387113	346	27	1	148
4656-18-1320	7314150387175	346	27	1	148
4656-18-340	7314150387144	346	27	1	148
4656-18-540	7314150387151	346	27	1	148
4656-18-940	7314150387168	346	27	1	148
4656-20-1320	7314150387212	346	27	1	148
4656-20-320	7314150387182	346	27	1	148
4656-20-520	7314150387199	346	27	1	148
4656-20-920	7314150387205	346	27	1	148
4656-22-1320	7314150387250	346	27	1	148
4656-22-320	7314150387229	346	27	1	148
4656-22-520	7314150387236	346	27	1	148
4656-22-920	7314150387243	346	27	1	148
4656-24-320	7314150387267	346	27	1	148
4656-24-520	7314150387274	346	27	1	148
4656-25-1320	7314150387311	346	27	1	148
4656-25-320	7314150387281	346	27	1	148
4656-25-520	7314150387298	346	27	1	148
4656-25-920	7314150387304	346	27	1	148
4656-26-520	7314150387328	346	27	1	148
4656-28-370	7314150387434	346	27	1	148
4656-28-570	7314150387458	346	27	1	149
4656-28-670	7314150387489	346	27	1	149
4656-28-920	7314150387526	346	27	1	149
4656-30-370	7314150387540	346	27	1	149
4656-30-570	7314150387571	346	27	1	149
4656-32-1320	7314150387649	346	27	1	149
4656-32-370	7314150387595	346	27	1	149
4656-32-570	7314150387618	346	27	1	149
4656-32-920	7314150387632	346	27	1	149
4656-35-370	7314150387656	346	27	1	149
4656-35-570	7314150387663	346	27	1	149
4656-35-670	7314150387670	346	27	1	149
4656-37-370	7314150387687	346	27	1	149
4656-37-570	7314150387694	346	27	1	149
4656-37-920	7314150387700	346	27	1	149
4656-38-370	7314150387717	346	27	1	149
4656-38-570	7314150387724	346	27	1	149
4656-40-1320	7314150387762	346	27	1	149
4656-40-370	7314150387731	346	27	1	149
4656-40-570	7314150387748	346	27	1	149
4656-40-920	7314150387755	346	27	1	149
4656-45-570	7314150387779	346	27	1	149
4656-45-920	7314150387786	346	27	1	149
4656-50-570	7314150387793	346	27	1	149
4656-52-570	7314150387809	346	27	1	149
4659-BUSHING-24	7314150388097	346	27	1	150
4659-FLAT -28	7314150387922	346	27	1	150
4659-FLAT -40	7314150387939	346	27	1	150
4659-FLAT -60	7314150387946	346	27	1	150
4659-HOLLOW-30	7314150387991	346	27	1	150
4659-POINT-28	7314150387892	346	27	1	150
4659-POINT-40	7314150387908	346	27	1	150
4659-POINT-60	7314150387915	346	27	1	150
4659-SPADE-40	7314150388073	346	27	1	150
4659-TILE-30-5	7314150388042	346	27	1	150
4659-TILE-30-8	7314150388059	346	27	1	150
4659-WIDE-30-8	7314150387953	346	27	1	150
4659-WIDE-35-11	7314150387977	346	27	1	150
4659-WIDE-36-5	7314150387984	346	27	1	150
4659-WING-C38-3	7314150388011	346	27	1	150
466-1000	7314150128327	336	15	4	484
466-1000-M					



CUENTA SUBGRUPO



474-150-0.60	7311518029876	362	10	10	490
474-150-0.80	7311518029883	362	10	10	490
4750-2PP-1	7314153014733	356	30	1	413
4750-3PB-1	7314153014719	356	30	1	413
4750-3PB-2	7314150187782	348	45	1	420
4750-BWC-1	7314153018809	356	30	1	413
4750-DHO-3	7314150289530	356	30	1	413
4750-DHO-4	7314150303908	348	45	1	420
4750-EP-1	7314153014726	356	30	1	413
4750-FOLTC-1	7314153019271	356	30	1	413
4750-HDB-2	7314150289486	356	30	1	414
4750-HDBS-2	7314150289479	356	30	1	414
4750-HDLB-1	7314153014757	356	30	1	414
4750-HDLB-TAH	7314150303892	348	45	1	420
4750-HHO-2	7314153014863	348	45	1	420
4750-JU3PB-1	7314153015747	356	30	1	413
4750-KNHO-0	7314150289462	356	30	1	414
4750-KNHO-1	7314153015839	356	30	1	414
4750-KP-1	7314153014771	348	10	1	414
4750-LV-1	7314150358052	356	30	1	412
4750-LV-2	7314150393800	356	30	1	412
4750-MPH-1	7314150291625	356	30	1	414
4750-PSTB-1	7314150340491	356	30	1	565
4750-QRFB-1	7314150289455	356	30	1	414
4750-ROCO-1	7314153015273	356	30	1	414
4750-TOCST-1	7314153018779	356	30	1	413
4750-UP-1	7314153014795	356	30	1	414
4750-UP-2	7314150187768	348	45	1	420
4750-VDEC	7314150222377	356	30	1	413
4750-VMPH-1	7314153014818	356	30	1	414
4750BMC10	7314150264032	356	25	1	411
4750BMC5	7314150264001	356	25	1	411
4750BMC6	7314150264018	356	25	1	411
4750BMC7	7314150277605	356	25	1	411
4750BMC9	7314150264025	356	25	1	411
4750FB1-19A	7314150277612	356	30	1	411
4750FB1-19B	7314150277629	356	30	4	411
4750FB2-19A	7314150277636	356	30	4	412
4750FB2-19TS001	7314150302772	356	40	1	410
4750FB2-24A	7314150277643	356	30	2	412
4750FB2W-24A	7314150277650	356	30	1	412
4750FB3-12	7314150277667	356	30	4	412
4750FB4-18	7314150277674	356	30	4	412
4750FB5A	7314150277704	356	30	1	412
4750FB5B	7314150277698	356	30	1	412
4750FB5C	7314150277681	356	30	8	412
4750PTB50	7314150275007	356	15	3	411
4750PTB60	7314150275014	356	15	3	411
4750PTBW47	7314150275021	356	15	1	411
4750RC01	7314150220151	356	15	1	397
4750RC02	7314150220168	356	15	1	397
4750RC021	7314150226641	356	15	1	397
4750RCHD-AC1	7314150229857	356	15	1	398
4750RCHD00	7314150271603	356	15	1	397
4750RCHD01	7314150227426	356	15	1	397
4750RCHD011	7314150229802	356	15	1	397
4750RCHD01AC1	7314150229819	356	15	1	398
4750RCHD01AC2	7314150229826	356	15	1	398
4750RCHD01FF1	7314150247578	356	15	1	408
4750RCHDW01	7314150227433	356	15	1	397
4750RCHDW01AC1	7314150229833	356	15	1	398
4750RCHDW01AC2	7314150229840	356	15	1	398
4750RCHDW01FF1	7314150247561	356	15	1	408
4750RCHDW01FF2	7314150249183	356	15	1	408
4750RCHDW01FF3	7314150249190	356	15	1	403
4750RCHDW01FF4	7314150309580	356	15	1	408
4750RCHDW01FF9	7314150345533	356	15	1	408
4750RCHDW01RED	7314150407538	356	15	1	397
4750RCHDW02	7314150227440	356	15	1	396
4750RCHDW02FF15	7314150347698	356	15	1	409
4750RCHDW02FF4	7314150309559	356	15	1	409
4750RCW01	7314150220182	356	15	1	397
4750RCW011	7314150226627	356	15	1	397
4750RCWD-AC1	7314150277179	356	15	1	397
4750RCWD-AC2	7314150277186	356	15	1	398
4750RCWD-AC3	7314150277193	356	15	1	398
4750RCWD-AC4	7314150277209	356	15	1	398
4750RCWD4	7314150277124	356	15	1	397
4750RCWD4-OR	7314150409501	356	15	1	397
4750RCWD4FF1	7314150302413	356	15	1	402
479-08	7311518025441	358	10	6	531
479-12	7311518025458	358	10	6	531
479-16	7311518025465	358	10	6	531
479-20	7314150319862	358	10	6	531
479-24	7311518025472	358	10	6	531
479-32	7311518025489	358	10	6	531
480-08	7311518025496	358	10	4	530
480-10	7311518025502	358	10	4	530
480-12	7311518025519	358	10	4	530
480-14	7311518025526	358	10	4	530
480-20	7314150319763	358	10	4	530
481-100	7311518005030	358	10	6	531
481-1000	7311518005092	358	10	6	531
481-1500	7311518025533	358	10	6	531
481-200	7311518005047	358	10	6	531
481-2000	7314150319855	358	10	6	531
481-300	7311518005054	358	10	6	531
481-400	7311518005061	358	10	6	531



CUENTA SUBGRUPO



481-500	7311518005078	358	10	6	531
481-800	7311518025540	358	10	6	531
482-25	7311518025557	358	10	6	531
482-28	7311518025564	358	10	6	531
482-30	7311518025571	358	10	6	531
482-35	7311518025595	358	10	6	531
482-40	7311518025601	358	10	6	531
482-45	7311518027551	358	10	6	531
483-16	7311518024314	358	10	6	531
483-20	7311518024321	358	10	6	531
483-22	7311518005108	358	10	6	531
483-25	7311518005115	358	10	6	531
483-28	7311518024284	358	10	6	531
483-30	7311518024291	358	10	6	531
4830	7314150100057	340	10	3	220
4831	7314150103393	340	10	3	220
4833	7314150100064	340	10	3	221
484-1000	7311518005122	358	10	6	531
484-1250	7311518005139	358	10	6	531
484-1500	7311518005146	358	10	6	531
484-2000	7311518024338	358	10	6	531
485	7311518005153	358	10	4	531
485W-650	7314150319770	358	10	4	531
485W-750	7314150319787	358	10	4	531
486	7311518005160	358	10	4	532
486-1800	7314150315307	336	15	5	485
486-1800WH	7314150315338	336	15	5	485
486-2000	7314150315314	336	15	5	485
486-2000WH	7314150315345	336	15	5	485
486-2400	7314150315321	336	15	5	485
486-2400WH	7314150315352	336	15	5	485
486-700	7314150338078	358	10	6	532
486F-700	7314150338085	358	10	6	532
486W-500	7314150319794	358	10	4	532
486W-600	7314150319800	358	10	4	532
488-2000	7314150337972	358	10	2	532
488-3000	7314150337989	358	10	2	532
488-4000	7314150337996	358	10	2	532
488-5000	7314150338009	358	10	2	532
488-6000	7314150338016	358	10	1	532
488F-2000	7314150338023	358	10	2	532
488F-3000	7314150338030	358	10	2	532
488F-4000	7314150338047	358	10	2	532
488F-5000	7314150338054	358	10	2	532
488F-6000	7314150338061	358	10	2	532
489-1100	7314150133055	358	10	1	534
489-1800	7314150133062	358	10	1	534
489-2700	7314150133079	358	10	1	534
489-3600	7314150133086	358	10	1	534
489-4500	7314150133093	358	10	1	534
489-5400	7314150133109	358	10	1	534
490-3.5	7311518025373	358	10	4	531
491-3000	7314150345199	358	10	4	534
491-4000	7314150345205	358	10	4	534
491-5000	7314150345212	358	10	4	534
491-6000	7314150345229	358	10	4	534
492-3.5	7311518025380	358	10	4	531
493-500	7314150338139	358	10	6	533
493-600	7314150338146	358	10	6	533
493F-500	7314150338153	358	10	6	533
493F-600	7314150338160	358	10	6	533
494-600	7311518025397	358	10	4	533
495-500	7314150338191	358	10	6	533
495-600	7314150338207	358	10	6	533
495F-500	7314150338184	358	10	6	533
495F-600	7314150338177	358	10	1	533
496-1500	7314150315147	336	15	5	485
496-1800	7314150315154	336	15	5	485
4M-10-11	7314151829438	366	10	10	54
4M-12-13	7314151829445	366	10	10	54
4M-14-15	7314151829476	366	10	10	54
4M-16-17	7314151829490	366	10	10	54
4M-17-19	7314151829506	366	10	10	54
4M-18-19	7314151829513	366	10	10	54
4M-20-22	7314151829520	366	10	10	54
4M-21-23	7314150205363	366	10	5	54
4M-24-26	7314150205370	366	10	1	54
4M-24-27	7314151829551	366	10	1	54
4M-25-28	7314150205387	366	10	1	54
4M-27-29	7314150205394	366	10	1	54
4M-30-32	7314151829575	366	10	1	54
4M-6-7	7314151829407	366	10	10	54
4M-8-9	7314151829414	366	10	10	54
4M/10C	7314150212972	366	10	1	54
4M/10T	7314151829605	366	10	1	54
4M/12C	7314150212989	366	10	1	55
4M/8					



CUENTA SUBGRUPO



502-SET2	7311518130664	328	20	5
502-SET6	7311518130633	328	20	5
5050	7314151083359	312	30	1
51-12	7311518044565	316	15	10
51-21	7311518003906	316	15	10
51-24	7311518003913	316	15	10
51-30	7311518003920	316	15	10
51-32	7311518003937	316	15	10
51-36	7311518003944	316	15	10
510031	7314150216338	350	40	5
510033	7314150216345	350	40	5
510034	7314150216314	350	40	10
5124-JS-H	7311518219352	330	20	4
5128-JS-H	7311518219369	330	20	4
52	7311518276027	312	10	12
527 D-160	7314150032723	340	50	3
527 D-200	7314150032730	340	50	5
527 GC-160	7314150205653	340	50	3
527 GC-200	7314150205660	340	50	3
527V-160	7314150126811	340	90	2
527V-200	7314150126828	340	90	2
528-700	7311518188993	364	40	1
528-COM	7311518188986	364	40	1
529-16-L	7314150198139	358	10	4
529-16-XL	7314150198146	358	10	4
529-20-L	7314150198160	358	10	4
529-20-XL	7314150198153	358	10	4
529-SK	7314150351350	364	40	1
529S-16-XL	7314150340330	358	10	4
529S-20-XL	7314150340347	358	10	4
541 D-150	7314150032754	340	45	5
541 D-200	7314150032761	340	45	5
541 D-250	7314150032778	340	45	5
5418	7314151084370	312	30	1
5419/6T	7314151821562	312	30	1
541D-180	7314150127160	340	45	5
541D-225	7314150127290	340	45	5
5463 AMT	7314151085025	340	80	5
5463 R	7314151085063	340	80	5
5463-120	7314151085001	340	80	5
5464 R	7314151085100	340	80	5
5464-105	7314151085087	340	80	5
54640	7314150215720	346	52	1
5465 AMT	7314151085148	340	80	5
5465 R	7314151085162	340	80	5
5467 AM	7314151085209	340	80	5
5467 R	7314151085223	340	80	5
5468-112	7314151085247	340	80	5
5469 AMI	7314151337803	340	80	1
5469 AMT	7314151085308	340	80	5
5469 B	7314151085322	340	80	5
5469 BI	7314151085346	340	80	5
5469 BR	7314151085384	340	80	5
5469 I	7314151085407	340	80	5
5469 R	7314151085421	340	80	5
5469-127	7314151085285	340	80	5
5470 I-140	7314151085506	340	80	5
5470 I-160	7314151085520	340	80	5
5470 R-140	7314151085568	340	80	5
5470 R-160	7314151085582	340	80	5
5470-120	7314151085452	340	80	5
5470-140	7314151085445	340	80	5
5470-160	7314151085469	340	80	5
5471 F-120	7314151085681	340	80	5
5471 F-145	7314151085704	340	80	5
5471 F-200	7314151085728	340	80	5
5471 F-250	7314151085742	340	80	5
5471 F-300	7314151085766	340	80	5
5471 FI-120	7314151085780	340	80	5
5471 FI-145	7314151085803	340	80	5
5471 FI-200	7314151085827	340	80	5
5471 FR-120	7314151085889	340	80	5
5471 FR-145	7314151085902	340	80	5
5473-90	7314151086183	340	80	5
5475 K	7314151086244	340	80	5
5475 R	7314151086268	340	80	5
5476 H	7314151086305	340	80	5
5479-130	7314151086398	340	80	5
5484 R	7314151086633	340	80	5
5488 AM	7314151821166	340	80	5
5489 AM	7314151821173	340	80	5
5490 AM	7314151821180	340	80	5
5493-115	7314151821234	340	80	5
5515B	7314151086978	312	30	25
5515GV	7314151481483	312	30	1
5515L	7314151481568	312	30	1
5515M	7314151086985	312	30	1
5515T	7314151589172	312	30	25
5515T-52	7314153021939	312	30	25
5516	7314151086992	340	80	5
5516 I	7314151087029	340	80	5
5517	7314151573843	340	80	5
5517 I	7314151573928	340	80	5
5518	7314151087043	340	80	5
5521	7314150215713	350	46	1
5540 AM	7314151821319	340	80	5
5541 AM	7314151821326	340	80	5
5543 AM	7314151821340	340	80	5



CUENTA SUBGRUPO



5544 AM	7314151821357	340	80	5	475
5545 AM	7314151821364	340	80	5	475
5546 AM	7314151821371	340	80	5	475
5547 AM	7314151821388	340	80	5	476
5549 AM	7314151821401	340	80	5	476
5550-3.2	7314151475673	350	40	10	480
5550-4.5	7314151475758	350	40	5	480
5551	7314151378479	350	40	1	480
5552	7314151378554	350	40	1	480
5553	7314151378639	350	40	1	480
5554	7314151378714	350	40	1	480
5568/5	7314151821210	340	80	1	477
5570/7	7314151473891	340	80	1	475
5571-145	7314151472818	340	80	5	476
5572-145	7314151473037	340	80	5	476
5573-145	7314151473112	340	80	5	476
5574-145	7314151473389	340	80	5	478
5575-145	7314151473464	340	80	5	475
5576-145	7314151473549	340	80	5	475
5576-145R	7314150115686	340	80	5	475
5577-145	7314151574062	340	80	5	477
5578-115	7314151547769	340	80	5	477
5579-115	7314151547844	340	80	5	477
5583 AM	7314151821296	340	80	5	476
5584 AM	7314151821302	340	80	5	476
5586 AM	7314151821289	340	80	5	476
5587 GAM	7314151821425	340	80	5	476
5588 AM	7314151821432	340	80	5	477
5589 AM	7314151821449	340	80	5	477
5590 AM	7314151821456	340	80	5	477
5600/4	7314151436773	350	40	1	480
5724-JS	7311518216085	330	20	1	569
5728-JS	7311518216092	330	20	1	569
5750	7311518280949	312	40	1	313
583D	7314150023721	340	70	4	518
584D	7314150023745	340	70	4	518
585D	7314150104185	340	70	4	518
586D	7314150104208	340	70	4	518
59/S100BC	7314150337637	346	48	1	166
59/S100BC-IP	7314150337644	346	48	8	166
59/S28-4	7314151847173	346	48	1	165
59/S31B	7314150325788	346	48	6	165
59/S31B-IP	7314150325795	346	48	12	165
59/S54BC	7314150337613	346	48	1	165
59/S54BC-IP	7314150337620	346	48	8	166
59S/0.5-3.0	7314150199815	346	48	1	159
59S/0.5-3.0-3P	7314150259205	346	48	50	159
59S/0.5-4.0	7314150199822	346	48	1	159
59S/0.5-4.0-3P	7314150259212	346	48	50	159
59S/0.6-3.5	7314150199839	346	48	1	159
59S/0.6-3.5-3P	7314150259229	346	48	50	159
59S/0.6-4.5	7314150199801	346	48	1	159
59S/0.6-4.5-3P	7314150201600	346	48	1	159
59S/0.8-5.5	7314150199849	346	48	1	159
59S/0.8-5.5-3P	7314150201624	346	48	1	159
59S/1.0-5.5	7314150199863	346	48	1	159
59S/1.0-5.5-3P	7314150258963	346	48	50	159
59S/1.2-6.5	7314150199887	346	48	1	159
59S/1.2-6.5-3P	7314150258970	346	48	50	159
59S/1.2-8.0	7314150199890	346	48	1	159
59S/1.2-8.0-3P	7314150258987	346	48	1	159
59S/1.6-10	7314150199846	346	48	1	159
59S/1.6-10-3P	7314150259236	346	48	50	159
59S/1.6-9.0	7314150199853	346	48	1	159
59S/1.6-9.0-3P	7314150259243	346	48	50	159
59S/125PH1	7314150206834	346	48	1	163
59S/125PH1-2P	7314150260553	346	48	25	163
59S/125PH2	7314150204298	346	48	1	163
59S/125PH2-2P	7314150260560	346	48	25	163
59S/125PH3	7314150204304	346	48	1	163
59S/125PH3-2P	7314150260577	346	48	25	163
59S/125PZ1	7314150200733	346	48	1	163
59S/125PZ1-2P	7314150260522	346	48	25	163
59S/125PZ2	7314150200740	346	48	1	163
59S/125PZ2-2P	7314150260539	346	48	25	163
59S/125PZ3	7314150200757	346	48	1	163
59S/125PZ3-2P	7314150260546	346	48	25	163
59S/150T15	7314150200764	346	48	1	163
59S/150T15-2P	7314150260584	346	48	1	163
59S/150T20	7314150200771	346	48	1	163
59S/150T20-2P	7314150260591	346	48	1	163
59S/150T25	7314150200788	346	48	1	163
59S/150T25-2P	7314150260607	346	48	1	163
59S/150T30	7314150200795	346	48	1	163
59S/150T30-2P	7314150260614	346	48	1	163
59S/17-1	7314150191499	346	48	1	164
59S/17-2	7314150191505	346	48	1	164
59S/17-3	7314150191512	346	48	1	164
59S/22-1	7314150204229	346	48	12	164
59S/22-2	7314150204236	346	48	12	164
59S/31-1	7314150191451	346	48	12	165
59S/31-2	7314150191468	346	48	1	165
59S/31-3	7314150191475	346	48	12	165
59S/50/0.6-3.5	7314150199976	346	48	1	161
59S/50/0.8-4.0	7314150200009	346	48	1	161
59S/50/0.8-5.5	7314150200023	346	48	1	161
59S/50/1.0-6.0	7314150200047	346	48	1	161
59S/50/1.2-6.5	7314150200061	346	48	1	161

59S/50/3.5-2P

CUENTA		SUBGRUPO			
59S/50/3.5-2P	7314150260027	346	48	50	161
59S/50/4.0-2P	7314150260041	346	48	50	161
59S/50/5.5-2P	7314150260065	346	48	50	161
59S/50/6.0-2P	7314150260089	346	48	1	161
59S/50/6.5-2P	7314150260102	346	48	50	161
59S/50H1/16	7314150248926	346	48	1	162
59S/50H1/4	7314150249015	346	48	1	162
59S/50H1/8	7314150248964	346	48	1	162
59S/50H2	7314150200160	346	48	1	162
59S/50H2-2P	7314150259298	346	48	50	162
59S/50H2.5	7314150200177	346	48	1	162
59S/50H2.5-2P	7314150259304	346	48	50	162
59S/50H3	7314150200184	346	48	1	162
59S/50H3-2P	7314150259335	346	48	50	162
59S/50H3/16	7314150248995	346	48	1	162
59S/50H3/32	7314150248940	346	48	1	162
59S/50H3/8	7314150249039	346	48	1	162
59S/50H4	7314150200191	346	48	1	162
59S/50H4-2P	7314150259359	346	48	50	162
59S/50H5	7314150200207	346	48	1	162
59S/50H5-2P	7314150259373	346	48	50	162
59S/50H5/16	7314150249022	346	48	1	162
59S/50H5/32	7314150248988	346	48	1	162
59S/50H5/64	7314150248933	346	48	1	162
59S/50H6	7314150200214	346	48	1	162
59S/50H6-2P	7314150259397	346	48	50	162
59S/50H7/32	7314150249008	346	48	1	162
59S/50H7/64	7314150248957	346	48	1	162
59S/50H8	7314150200221	346	48	1	162
59S/50H8-2P	7314150259410	346	48	50	162
59S/50H9/64	7314150248971	346	48	1	162
59S/50PH1	7314150199860	346	48	1	161
59S/50PH1-2P	7314150203642	346	48	1	161
59S/50PH2	7314150199877	346	48	1	161
59S/50PH2-2P	7314150203758	346	48	1	161
59S/50PH3	7314150199891	346	48	1	161
59S/50PH3-2P	7314150203802	346	48	1	161
59S/50PZ1	7314150199914	346	48	1	161
59S/50PZ1-2P	7314150204007	346	48	1	161
59S/50PZ2	7314150199938	346	48	1	161
59S/50PZ2-2P	7314150204014	346	48	1	161
59S/50PZ3	7314150199952	346	48	1	161
59S/50PZ3-2P	7314150204021	346	48	1	161
59S/50R1	7314150200238	346	48	1	162
59S/50R1-2P	7314150259441	346	48	50	162
59S/50R2	7314150200245	346	48	1	162
59S/50R2-2P	7314150259472	346	48	50	162
59S/50R3	7314150200252	346	48	1	162
59S/50R3-2P	7314150259502	346	48	50	162
59S/50T10	7314150200092	346	48	1	162
59S/50T10-2P	7314150201723	346	48	1	162
59S/50T15	7314150200108	346	48	1	162
59S/50T15-2P	7314150201730	346	48	1	162
59S/50T20	7314150200115	346	48	1	162
59S/50T20-2P	7314150201747	346	48	1	162
59S/50T25	7314150200122	346	48	1	162
59S/50T25-2P	7314150201754	346	48	1	162
59S/50T27	7314150200139	346	48	1	162
59S/50T30	7314150200146	346	48	1	162
59S/50T30-2P	7314150201761	346	48	1	162
59S/50T40	7314150200153	346	48	1	162
59S/50T40-2P	7314150259281	346	48	50	162
59S/50T8	7314150200085	346	48	1	162
59S/50T8-2P	7314150262809	346	48	50	162
59S/7-1	7314150191536	346	48	1	163
59S/7-2	7314150191543	346	48	1	164
59S/7-3	7314150191550	346	48	1	164
59S/7-4	7314150191567	346	48	1	164
59S/70PH1	7314150200269	346	48	1	162
59S/70PH1-2P	7314150259526	346	48	1	162
59S/70PH2	7314150200276	346	48	1	162
59S/70PH2-2P	7314150259557	346	48	25	162
59S/70PZ1	7314150200283	346	48	1	162
59S/70PZ1-2P	7314150259564	346	48	1	162
59S/70PZ2	7314150200290	346	48	1	162
59S/70PZ2-2P	7314150260331	346	48	1	162
59S/70PZ3	7314150200306	346	48	1	162
59S/70PZ3-2P	7314150260348	346	48	1	162
59S/70T10	7314150200313	346	48	1	162
59S/70T10-2P	7314150260355	346	48	1	162
59S/70T15	7314150200566	346	48	1	162
59S/70T15-2P	7314150260362	346	48	25	162
59S/70T20	7314150200573	346	48	1	162
59S/70T20-2P	7314150201839	346	48	1	162
59S/70T25	7314150200580	346	48	1	162
59S/70T25-2P	7314150260379	346	48	25	162
59S/70T27	7314150200597	346	48	1	162
59S/70T27-2P	7314150260386	346	48	1	162
59S/70T30	7314150200603	346	48	1	162
59S/70T30-2P	7314150260393	346	48	1	162
59S/70T40	7314150200610	346	48	1	162
59S/70T40-2P	7314150260409	346	48	1	162
59S/70TR15	7314150200627	346	48	1	162
59S/70TR15-2P	7314150260416	346	48	1	162
59S/70TR20	7314150200634	346	48	1	162
59S/70TR20-2P	7314150260423	346	48	25	163
59S/70TR25	7314150200641	346	48	1	163
59S/70TR25-2P	7314150260430	346	48	25	163

CUENTA		SUBGRUPO			
59S/70TR27	7314150200658	346	48	1	163
59S/70TR27-2P	7314150260447	346	48	25	163
59S/70TR30	7314150200665	346	48	1	163
59S/70TR30-2P	7314150260454	346	48	25	163
59S/70TR40	7314150200672	346	48	1	163
59S/70TR40-2P	7314150260461	346	48	25	163
59S/H1.5	7314150198924	346	48	1	160
59S/H1.5-3P	7314150258994	346	48	50	160
59S/H1/16	7314150204205	346	48	1	160
59S/H1/16-3P	7314150259021	346	48	50	160
59S/H1/4	7314150199266	346	48	1	161
59S/H1/4-3P	7314150259120	346	48	50	161
59S/H1/8	7314150199174	346	48	1	160
59S/H1/8-3P	7314150259069	346	48	50	160
59S/H10	7314150199075	346	48	1	160
59S/H10-3P	7311518333638	346	48	25	160
59S/H2	7314150198955	346	48	1	160
59S/H2-3P	7314150259007	346	48	50	160
59S/H2.5	7314150198962	346	48	1	160
59S/H2.5-3P	7314150259014	346	48	50	160
59S/H3	7314150198986	346	48	1	160
59S/H3-3P	7314150201662	346	48	1	160
59S/H3/16	7314150199228	346	48	1	161
59S/H3/16-3P	7314150259090	346	48	1	161
59S/H3/32	7314150199136	346	48	1	160
59S/H3/32-3P	7314150259045	346	48	50	160
59S/H3/8	7314150204212	346	48	1	161
59S/H3/8-3P	7314150259144	346	48	25	161
59S/H3BALL	7314150200689	346	48	1	163
59S/H3BALL-2P	7314150260478	346	48	1	163
59S/H4	7314150198993	346	48	1	160
59S/H4-3P	7314150201679	346	48	1	160
59S/H4-IPB	7314150225767	346	48	500	160
59S/H4BALL	7314150200696	346	48	1	163
59S/H4BALL-2P	7314150260485	346	48	1	163
59S/H5	7314150199013	346	48	1	160
59S/H5-3P	7314150201686	346	48	1	160
59S/H5/16	7314150199273	346	48	1	161
59S/H5/16-3P	7314150259137	346	48	50	161
59S/H5/32	7314150199204	346	48	1	161
59S/H5/32-3P	7314150259083	346	48	50	161
59S/H5/64	7314150199112	346	48	1	160
59S/H5/64-3P	7314150259038	346	48	50	160
59S/H5BALL	7314150200702	346	48	1	163
59S/H5BALL-2P	7314150260492	346	48	1	163
59S/H6	7314150199037	346	48	1	160
59S/H6-3P	7314150201693	346	48	1	160
59S/H6BALL	7314150200719	346	48	1	163
59S/H6BALL-2P	7314150260508	346	48	1	163
59S/H7/32	7314150199242	346	48	1	161
59S/H7/32-3P	7314150259113	346	48	50	161
59S/H7/64	7314150199150	346	48	1	160
59S/H7/64-3P	7314150259052	346	48	50	160
59S/H8	7314150199051	346	48	1	160
59S/H8-3P	7314150201709	346	48	1	160
59S/H8BALL	7314150200726	346	48	1	163
59S/H8BALL-2P	7314150260515	346	48	1	163
59S/H9/64	7314150199198	346	48	1	160
59S/H9/64-3P	7314150259076	346	48	1	160
59S/HBALL-3P	7314150201716	346	48	1	163
59S/M3	7314150199730	346	48	1	161
59S/M3-3P	7314150259151	346	48	50	161
59S/M4	7314150199754	346	48	1	161
59S/M4-3P	7314150259168	346	48	50	161
59S/M5	7314150199778	346	48	1	161
59S/M5-3P	7314150259175	346	48	50	161
59S/M6	7314150199792	346	48	1	161
59S/M6-3P	7314150259182	346	48	50	161
59S/M8	7314150199808	346	48	1	161
59S/M8-3P	7314150259199	346	48	50	161
59S/PH0	7314150198177	346	48	1	159
59S/PH0-3P	7314150258819	346	48	50	159
59S/PH1	7314150198313	346	48	1	159
59S/PH1-30P	7314150200801	346	48	1	159
59S/PH1-3P	7314150201396	346	48	1	159
59S/PH1-IP	7314150206780	346	48	100	159
59S/PH1-IPB	7314150225743	346	48	500	159
59S/PH1COMBI-2P	7314150215669	346	48	1	163
59S/PH2	7314150198320	346	48	1	159
59S/PH2-30P	7314150200818	346	48	1	159
59S/PH2-3P	7314150201402	346	48	1	159
59S/PH2-IP	7314150206797	346	48	100	159
59S/PH2-IPB	7314150204038	346	48	500	159
59S/PH2COMBI-2P	7314150203604	346	48	1	163
59S/PH2G	7314150204182	346</			



CUENTA SUBGRUPO



59S/PZ1-3P	7314150201426	346	48	1	160
59S/PZ1-IP	7314150206803	346	48	100	160
59S/PZ1-IPB	7314150204373	346	48	500	160
59S/PZ2	7314150198405	346	48	1	160
59S/PZ2-30P	7314150200856	346	48	1	160
59S/PZ2-3P	7314150201433	346	48	1	160
59S/PZ2-IP	7314150206810	346	48	100	160
59S/PZ2-IPB	7314150204380	346	48	500	160
59S/PZ3	7314150198429	346	48	1	160
59S/PZ3-30P	7314150200863	346	48	1	160
59S/PZ3-3P	7314150201440	346	48	1	160
59S/PZ3-IPB	7314150225736	346	48	500	160
59S/PZ4	7314150198436	346	48	1	160
59S/R1	7314150199310	346	48	1	161
59S/R1-3P	7314150201631	346	48	1	161
59S/R2	7314150199341	346	48	1	161
59S/R2-3P	7314150201648	346	48	1	161
59S/R3	7314150199365	346	48	1	161
59S/R3-3P	7314150201655	346	48	1	161
59S/R4	7314150232109	346	48	1	161
59S/T10	7314150198528	346	48	1	160
59S/T10-30P	7314150200870	346	48	1	160
59S/T10-3P	7314150201457	346	48	1	160
59S/T15	7314150198535	346	48	1	160
59S/T15-30P	7314150200887	346	48	1	160
59S/T15-3P	7314150201464	346	48	1	160
59S/T20	7314150198542	346	48	1	160
59S/T20-30P	7314150200894	346	48	1	160
59S/T20-3P	7314150201471	346	48	1	160
59S/T25	7314150198566	346	48	1	160
59S/T25-30P	7314150200900	346	48	1	160
59S/T25-3P	7314150201488	346	48	1	160
59S/T27	7314150198580	346	48	1	160
59S/T27-3P	7314150201495	346	48	1	160
59S/T3	7314150198443	346	48	1	160
59S/T3-3P	7314150258840	346	48	50	160
59S/T30	7314150198597	346	48	1	160
59S/T30-30P	7314150200924	346	48	1	160
59S/T30-3P	7314150201501	346	48	1	160
59S/T4	7314150198450	346	48	1	160
59S/T4-3P	7314150258857	346	48	50	160
59S/T40	7314150198610	346	48	1	160
59S/T40-30P	7314150200931	346	48	1	160
59S/T40-3P	7314150201518	346	48	1	160
59S/T45	7314150198641	346	48	1	160
59S/T45-3P	7314150258918	346	48	50	160
59S/T5	7314150198467	346	48	1	160
59S/T5-3P	7314150258864	346	48	50	160
59S/T50	7314150198658	346	48	1	160
59S/T50-3P	7314150258925	346	48	50	160
59S/T6	7314150198474	346	48	1	160
59S/T6-3P	7314150258871	346	48	50	160
59S/T7	7314150198498	346	48	1	160
59S/T7-3P	7314150258888	346	48	50	160
59S/T8	7314150198504	346	48	1	160
59S/T8-3P	7314150258895	346	48	50	160
59S/T9	7314150198511	346	48	1	160
59S/T9-3P	7314150258901	346	48	50	160
59S/TR10	7314150198702	346	48	1	160
59S/TR10-3P	7314150201525	346	48	1	160
59S/TR15	7314150198719	346	48	1	160
59S/TR15-3P	7314150201532	346	48	1	160
59S/TR20	7314150198726	346	48	1	160
59S/TR20-3P	7314150201549	346	48	1	160
59S/TR25	7314150198740	346	48	1	160
59S/TR25-3P	7314150201556	346	48	1	160
59S/TR27	7314150198757	346	48	1	160
59S/TR27-3P	7314150201570	346	48	1	160
59S/TR30	7314150198771	346	48	1	160
59S/TR30-3P	7314150201587	346	48	1	160
59S/TR40	7314150198795	346	48	1	160
59S/TR40-3P	7314150201594	346	48	1	160
59S/TR7	7314150198672	346	48	1	160
59S/TR7-3P	7314150258932	346	48	50	160
59S/TR8	7314150198689	346	48	1	160
59S/TR8-3P	7314150258949	346	48	50	160
59S/TR9	7314150198696	346	48	1	160
59S/TR9-3P	7314150258956	346	48	50	160
59S/TS-0	7314150199389	346	48	1	161
59S/TS-1	7314150199396	346	48	1	161
59S/TS-1/4	7314150199594	346	48	1	161
59S/TS-10	7314150199570	346	48	1	161
59S/TS-2	7314150199419	346	48	1	161
59S/TS-3	7314150199433	346	48	1	161
59S/TS-4	7314150199457	346	48	1	161
59S/TS-5	7314150199518	346	48	1	161
59S/TS-6	7314150199532	346	48	1	161
59S/TS-8	7314150199556	346	48	1	161
59S/TW0	7314150199617	346	48	1	161
59S/TW1	7314150199631	346	48	1	161
59S/TW2	7314150199655	346	48	1	161
59S/TW3	7314150199679	346	48	1	161
59S/TW4	7314150199693	346	48	1	161
59S/TW5	7314150199716	346	48	1	161
6	8412814220048	350	46	1	197
6-342-06-2-0	7311518021179	324	40	10	33
6-342-06-2-2	7311518244170	324	40	5	33
6-342-08-1-0	7311518021726	324	40	10	33



CUENTA SUBGRUPO



6-342-08-1-2	7311518028282	324	40	5	33
6-342-08-2-0	7311518021733	324	40	10	33
6-342-08-2-2	7311518005375	324	40	5	33
6-342-10-1-0	7311518021757	324	40	10	33
6-342-10-1-2	7311518005382	324	40	5	33
6-342-10-2-0	7311518021764	324	40	10	33
6-342-10-2-2	7311518005399	324	40	5	33
6-343-08-2-0	7311518021801	324	40	10	33
6-343-08-2-2	7311518001070	324	40	5	33
6-343-08-3-0	7311518021818	324	40	10	33
6-343-10-2-0	7311518021825	324	40	10	33
6-343-10-2-2	7311518001094	324	40	5	33
6-343-10-3-0	7311518021832	324	40	10	33
6-344-08-2-0	7311518021887	324	40	10	33
6-344-08-2-2	7311518005344	324	40	5	33
6-344-10-2-0	7311518021900	324	40	10	33
6-344-10-2-2	7311518005351	324	40	5	33
6-345-08-1-2	7311518028312	324	40	5	34
6-345-08-2-0	7311518021948	324	40	10	33
6-345-08-2-2	7311518005412	324	40	5	34
6-345-10-1-2	7311518005429	324	40	5	34
6-345-10-2-0	7311518021955	324	40	10	33
6-470-08-2-2	7311518242008	324	40	5	34
600-3	7314150124787	350	20	1	185
600.003.010	8412814600000	322	30	1	342
600.005.012	8412814600017	322	30	1	342
601000800	8413345202299	318	15	1	527
601001000	8413345202305	318	15	1	527
601001250	8413345202312	318	15	1	527
601001500	8413345202329	318	15	1	527
6010H0800	8413345015769	318	15	1	528
6010H1000	8413345015776	318	15	1	528
6010H1250	8413345015783	318	15	1	528
6010H1500	8413345015790	318	15	1	528
6010M0800	8413345015806	318	15	1	527
6010M1000	8413345116619	318	15	1	527
6010M1250	8413345015820	318	15	1	527
6010M1500	8413345015837	318	15	1	527
602-4-LA	7314150224357	350	20	1	185
604-5	7314150124800	350	20	1	185
6040M0630	8413345124126	318	15	1	528
605-10-PC-AU	7314150186334	350	20	1	186
605-6	7314150153770	350	20	1	185
605-6-PC	7314150184057	350	20	1	186
606-6	7314150124824	350	20	1	186
6070H1000	8413345030656	318	15	1	527
6070H1250	8413345084833	318	15	1	527
6070H1500	8413345030663	318	15	1	527
6070H1750	8413345030670	318	15	1	527
607201000	8413345030533	318	15	1	527
607201250	8413345030540	318	15	1	527
607201500	8413345030557	318	15	1	527
607201750	8413345030564	318	15	1	527
6072M1000	8413345015813	318	15	1	527
6072M1500	8413345137454	318	15	1	527
6072M1750	8413345030687	318	15	1	527
607T/17-1	7314150191529	346	48	1	167
607T/31-1	7314150191482	346	48	12	167
607T/7-1	7314150191574	346	48	1	167
607T/PH1	7314150199488	346	48	1	167
607T/PH1-2P	7314150201136	346	48	1	167
607T/PH2	7314150199495	346	48	1	167
607T/PH2-2P	7314150201143	346	48	1	167
607T/PH3	7314150199501	346	48	1	167
607T/PH3-2P	7314150201150	346	48	1	167
607T/PZ1	7314150199525	346	48	1	167
607T/PZ1-2P	7314150201167	346	48	1	167
607T/PZ2	7314150199549	346	48	1	167
607T/PZ2-2P	7314150201174	346	48	1	167
607T/PZ3	7314150199563	346	48	1	167
607T/PZ3-2P	7314150201181	346	48	1	167
607T/T10	7314150199648	346	48	1	167
607T/T10-2P	7314150201198	346	48	1	167
607T/T15	7314150199662	346	48	1	167
607T/T15-2P	7314150201204	346	48	1	167
607T/T20	7314150199686	346	48	1	167
607T/T20-2P	7314150201211	346	48	1	167
607T/T25	7314150199709	346	48	1	167
607T/T25-2P	7314150201228	346	48	1	167
607T/T27	7314150199723	346	48	1	167
607T/T30	7314150199747	346	48	1	167
607T/T30-2P	7314150201235	346	48	1	167
607T/T40	7314150199761	346	48	1	167
6					



CUENTA SUBGRUPO



611-8-150	7314150124404	350	20	10	184
611-8-175	7314150124411	350	20	10	184
612-5	7314150124817	350	20	1	186
613-3-100	7314150124442	350	20	10	184
613-3-75	7314150124435	350	20	10	184
613-3.5-100	7314150124459	350	20	10	184
613-4-100	7314150124466	350	20	10	184
613-4-125	7314150124473	350	20	10	184
613-5.5-150	7314150124497	350	20	10	184
613-6.5-150	7314150124503	350	20	10	184
615-0-75	7314150124558	350	20	10	184
615-1-100	7314150124565	350	20	10	184
615-2-125	7314150124572	350	20	10	185
615-2-25	7314150124596	350	20	10	184
615-3-150	7314150124589	350	20	10	185
616-0-75	7314150124510	350	20	10	185
616-1-100	7314150124527	350	20	10	185
616-2-125	7314150124534	350	20	10	185
616-3-150	7314150124541	350	20	10	185
618-10-75	7314150124619	350	20	10	185
618-15-100	7314150124626	350	20	10	185
618-20-100	7314150124633	350	20	10	185
618-25-125	7314150124640	350	20	10	185
618-27-125	7314150124657	350	20	10	185
618-30-150	7314150124664	350	20	10	185
618-40-150	7314150124671	350	20	10	185
61H/50PH1	7314150200382	346	48	1	155
61H/50PH1-2P	7314150261963	346	48	1	155
61H/50PH2	7314150200399	346	48	1	155
61H/50PH2-2P	7314150261970	346	48	1	155
61H/50PH3	7314150200405	346	48	1	155
61H/50PH3-2P	7314150261987	346	48	1	155
61H/50PZ1	7314150200412	346	48	1	155
61H/50PZ1-2P	7314150261994	346	48	1	155
61H/50PZ2	7314150200429	346	48	1	155
61H/50PZ2-2P	7314150262007	346	48	1	155
61H/50PZ3	7314150200436	346	48	1	155
61H/50PZ3-2P	7314150262014	346	48	1	155
61H/50T10	7314150200443	346	48	1	155
61H/50T10-2P	7314150262021	346	48	1	155
61H/50T15	7314150200450	346	48	1	155
61H/50T15-2P	7314150262038	346	48	1	155
61H/50T20	7314150200467	346	48	1	155
61H/50T20-2P	7314150262045	346	48	1	155
61H/50T25	7314150200474	346	48	1	155
61H/50T25-2P	7314150262052	346	48	1	155
61H/50T30	7314150200481	346	48	1	155
61H/50T30-2P	7314150262069	346	48	1	155
61H/50T40	7314150200498	346	48	1	155
61H/50T40-2P	7314150262076	346	48	1	155
61H/PH1	7314150199006	346	48	1	155
61H/PH1-2P	7314150261840	346	48	1	155
61H/PH2	7314150199020	346	48	1	155
61H/PH2-2P	7314150201082	346	48	1	155
61H/PH3	7314150199044	346	48	1	155
61H/PH3-2P	7314150261857	346	48	1	155
61H/PZ1	7314150199068	346	48	1	155
61H/PZ1-2P	7314150261888	346	48	1	155
61H/PZ2	7314150199082	346	48	1	155
61H/PZ2-2P	7314150201099	346	48	1	155
61H/PZ3	7314150199105	346	48	1	155
61H/PZ3-2P	7314150261895	346	48	1	155
61H/T10	7314150199129	346	48	1	156
61H/T10-2P	7314150261901	346	48	1	156
61H/T15	7314150199143	346	48	1	156
61H/T15-2P	7314150261918	346	48	1	156
61H/T20	7314150199167	346	48	1	156
61H/T20-2P	7314150261925	346	48	1	156
61H/T25	7314150199181	346	48	1	156
61H/T25-2P	7314150261932	346	48	1	156
61H/T30	7314150199211	346	48	1	156
61H/T30-2P	7314150261949	346	48	1	156
61H/T40	7314150199235	346	48	1	156
61H/T40-2P	7314150261956	346	48	1	156
620-6	7314150128594	350	34	1	186
622-3P	7314150427727	340	75	1	226
6221D	7314150421596	340	75	10	226
6222D	7314150421589	340	75	10	226
6223D	7314150421558	340	75	8	226
6223D IP	7314150421794	340	75	8	226
6224	7314150421619	340	75	4	226
6224D	7314150421565	340	75	5	226
6224D IP	7314150421800	340	75	5	226
6225D	7314150421572	340	75	5	226
6225D IP	7314150421817	340	75	5	226
623-3-100	7314150128518	350	34	10	439
623-3.5-100	7314150128525	350	34	10	439
623-4-100	7314150128532	350	34	10	439
623-5.5-125	7314150128549	350	34	10	439
623-6.5-150	7314150128556	350	34	10	439
625	7311518221614	362	10	5	490
625-0-100	7314150128563	350	34	10	439
625-1-150	7314150128570	350	34	10	439
625-2-175	7314150128587	350	34	10	439
625-DROP	7311518221638	362	10	10	490
625-PEAR	7311518221621	362	10	10	490
625-ROUND	7311518221645	362	10	10	490
62TIN/50PH1	7314150200504	346	48	1	167



CUENTA SUBGRUPO



62TIN/50PH1-2P	7314150262243	346	48	1	167
62TIN/50PH2	7314150200511	346	48	1	167
62TIN/50PH2-2P	7314150262250	346	48	1	167
62TIN/50PH3	7314150200528	346	48	1	167
62TIN/50PH3-2P	7314150262267	346	48	1	167
62TIN/50PZ1	7314150200535	346	48	1	167
62TIN/50PZ1-2P	7314150262274	346	48	1	167
62TIN/50PZ2	7314150200542	346	48	1	167
62TIN/50PZ2-2P	7314150262281	346	48	1	167
62TIN/50PZ3	7314150200559	346	48	1	167
62TIN/50PZ3-2P	7314150262298	346	48	1	167
62TIN/7-1	7314150203505	346	48	1	167
62TIN/PH1	7314150199259	346	48	1	166
62TIN/PH1-2P	7314150262083	346	48	1	166
62TIN/PH2	7314150199297	346	48	1	166
62TIN/PH2-2P	7314150262090	346	48	1	166
62TIN/PH3	7314150199303	346	48	1	166
62TIN/PH3-2P	7314150262106	346	48	1	166
62TIN/PZ1	7314150199327	346	48	1	166
62TIN/PZ1-2P	7314150201105	346	48	1	166
62TIN/PZ2	7314150199334	346	48	1	166
62TIN/PZ2-2P	7314150201112	346	48	1	166
62TIN/PZ3	7314150199358	346	48	1	166
62TIN/PZ3-2P	7314150201129	346	48	1	166
62TIN/T10	7314150199372	346	48	1	166
62TIN/T10-2P	7314150262113	346	48	1	166
62TIN/T15	7314150199402	346	48	1	166
62TIN/T15-2P	7314150262144	346	48	1	166
62TIN/T20	7314150199426	346	48	1	166
62TIN/T20-2P	7314150262168	346	48	1	166
62TIN/T25	7314150199440	346	48	1	166
62TIN/T25-2P	7314150262212	346	48	1	166
62TIN/T30	7314150199464	346	48	1	166
62TIN/T30-2P	7314150262229	346	48	1	166
62TIN/T40	7314150199471	346	48	1	166
62TIN/T40-2P	7314150262236	346	48	1	166
63D/50PH1	7314150200351	346	48	1	155
63D/50PH2	7314150200368	346	48	1	155
63D/50PH3	7314150200375	346	48	1	155
63D/50PZ1	7314150200320	346	48	1	155
63D/50PZ2	7314150200337	346	48	1	155
63D/50PZ3	7314150200344	346	48	1	155
63D/7-1	7314150191604	346	48	1	155
63D/PH1	7314150198917	346	48	1	154
63D/PH1-2P	7314150201051	346	48	1	154
63D/PH2	7314150198931	346	48	1	154
63D/PH2-2P	7314150201068	346	48	1	154
63D/PH2G	7314150198979	346	48	1	154
63D/PH2G-2P	7314150201075	346	48	1	154
63D/PH3	7314150198948	346	48	1	154
63D/PH3-2P	7314150262342	346	48	1	154
63D/PZ1	7314150198856	346	48	1	154
63D/PZ1-2P	7314150201037	346	48	1	154
63D/PZ2	7314150198870	346	48	1	154
63D/PZ2-2P	7314150201044	346	48	1	154
63D/PZ3	7314150198894	346	48	1	154
63D/PZ3-2P	7314150262335	346	48	1	154
63D/T10	7314150198865	346	48	1	155
63D/T10-2P	7314150262304	346	48	1	155
63D/T15	7314150198733	346	48	1	155
63D/T15-2P	7314150201006	346	48	1	155
63D/T20	7314150198764	346	48	1	155
63D/T20-2P	7314150201013	346	48	1	155
63D/T25	7314150198818	346	48	1	155
63D/T25-2P	7314150201020	346	48	1	155
63D/T30	7314150198788	346	48	1	155
63D/T30-2P	7314150262311	346	48	1	155
63D/T40	7314150198832	346	48	1	155
63D/T40-2P	7314150262328	346	48	1	155
64A/PH1	7314150198481	346	48	1	154
64A/PH1-2P	7314150200948	346	48	1	154
64A/PH2	7314150198559	346	48	1	154
64A/PH2-2P	7314150200955	346	48	1	154
64A/PH3	7314150198573	346	48	1	154
64A/PH3-2P	7314150200962	346	48	1	154
64A/PZ1	7314150198603	346	48	1	154
64A/PZ1-2P	7314150200979	346	48	1	154
64A/PZ2	7314150198627	346	48	1	154
64A/PZ2-2P	7314150200986	346	48	1	154
64A/PZ3	7314150198634	346	48	1	154
64A/PZ3-2P	7314150200993	346	48	1	154
650	7311518221591	362	10	5	490
65I/7-1	7314150204113	346	48	1	471
65I/PH1	7314150199785	346	48	1	471



CUENTA SUBGRUPO



65I/T15-2P	7314150201310	346	48	1	471
65I/T20	7314150200016	346	48	1	471
65I/T20-2P	7314150201327	346	48	1	471
65I/T25	7314150200030	346	48	1	471
65I/T25-2P	7314150201334	346	48	1	471
65I/T30	7314150200054	346	48	1	471
65I/T30-2P	7314150201341	346	48	1	471
65I/T40	7314150200078	346	48	1	471
65I/T40-2P	7314150201358	346	48	1	471
665	7311518221607	362	10	5	490
6700SM-10	7314151088026	354	10	5	64
6700SM-11	7314151088033	354	10	5	64
6700SM-12	7314151088040	354	10	5	64
6700SM-13	7314151088057	354	10	5	64
6700SM-14	7314151088064	354	10	5	64
6700SM-4	7314151087944	354	10	5	64
6700SM-4.5	7314151087951	354	10	5	64
6700SM-5	7314151087968	354	10	5	64
6700SM-5.5	7314151087975	354	10	5	64
6700SM-6	7314151087982	354	10	5	64
6700SM-7	7314151087999	354	10	5	64
6700SM-8	7314151088002	354	10	5	64
6700SM-9	7314151088019	354	10	5	64
6700SZ-1/2	7314151088194	354	10	5	64
6700SZ-1/4	7314151088132	354	10	5	64
6700SZ-1/8	7314150346349	354	10	5	64
6700SZ-11/32	7314151088163	354	10	5	64
6700SZ-3/16	7314151088118	354	10	5	64
6700SZ-3/8	7314151088170	354	10	5	64
6700SZ-5/16	7314151088156	354	10	5	64
6700SZ-5/32	7314151808556	354	10	5	64
6700SZ-7/16	7314151088187	354	10	5	64
6700SZ-7/32	7314151088125	354	10	5	64
6700SZ-9/16	7314151088200	354	10	5	64
6700SZ-9/32	7314151088149	354	10	5	64
6700TORX-E10	7314153011725	354	10	5	64
6700TORX-E4	7314153011671	354	10	5	64
6700TORX-E5	7314153011688	354	10	5	64
6700TORX-E6	7314153011695	354	10	5	64
6700TORX-E7	7314153011701	354	10	5	64
6700TORX-E8	7314153011718	354	10	5	64
6706TE	7314150220199	354	25	1	75
6708DMB	7314150220205	354	25	1	75
6709-IP10	7314150354498	354	10	1	68
6709-IP15	7314150354504	354	10	1	68
6709-IP20	7314150354511	354	10	1	68
6709-IP25	7314150354528	354	10	1	68
6709-IP27	7314150354535	354	10	1	68
6709-IP30	7314150354542	354	10	1	68
6709-IP40	7314150354559	354	10	1	68
6709-IP45	7314150354566	354	10	1	68
6709F-4.5	7314151830762	354	10	5	67
6709F-5.5	7314151830779	354	10	5	67
6709F-6.5	7314150220397	354	10	5	67
6709F-8	7314151830786	354	10	5	67
6709HL	7314150128457	354	15	1	66
6709M-3	7314151830656	354	10	5	68
6709M-4	7314151830663	354	10	5	68
6709M-5	7314151830670	354	10	5	68
6709M-6	7314151830687	354	10	5	68
6709M-8	7314151830694	354	10	5	68
6709PH-1	7314151830700	354	10	5	67
6709PH-2	7314151830717	354	10	5	67
6709PH-3	7314151830724	354	10	5	67
6709PZ-1	7314151830731	354	10	5	67
6709PZ-2	7314151830748	354	10	5	67
6709PZ-3	7314151830755	354	10	5	67
6709TORX-R-T10	7314153002471	354	10	1	68
6709TORX-R-T15	7314153002488	354	10	1	68
6709TORX-R-T20	7314153002495	354	10	1	68
6709TORX-R-T25	7314153002501	354	10	1	68
6709TORX-R-T8	7314153002464	354	10	1	68
6709TORX-T10	7314151811679	354	10	5	68
6709TORX-T15	7314151811686	354	10	5	68
6709TORX-T20	7314151811693	354	10	5	68
6709TORX-T25	7314151811709	354	10	5	68
6709TORX-T27	7314151811716	354	10	5	68
6709TORX-T30	7314151811723	354	10	5	68
6709TORX-T40	7314153002457	354	10	5	68
6709TORX-T8	7314153002440	354	10	5	68
6709TORX-T9	7314151811662	354	10	5	68
671002600	8413345128971	362	15	50	493
671002850	8413345128988	362	15	50	493
6711MB	7314150220298	354	25	1	75
6712R	7314151838225	354	25	1	69
6712RN	7314151838232	354	25	1	70
6713MH	7314150220212	354	25	1	75
6715GE	7314151831370	354	25	1	72
6715GJ	7314151831363	354	25	1	72
6715MG	7314151831349	354	25	1	71
6715MGS	7314151831332	354	25	1	70
6715MZ	7314153003218	354	25	1	73
6715PZ	7314151837525	354	25	1	72
6717MBP	7314150218806	354	25	1	71
6719MHR	7314150218783	354	25	1	70
6719SM	7314151820817	354	25	1	71
6720NM	7314151088262	354	25	1	72
6721NM	7314151088309	354	25	1	71



CUENTA SUBGRUPO



6722M	7314151594411	354	25	1	71
6729MHP	7314150218752	354	25	1	70
6729MHR	7314150218769	354	25	1	70
6729SM	7314153003225	354	25	1	73
6729SZ	7314153003232	354	25	1	73
6730MBP	7314150218776	354	25	1	71
677-10	7314150362486	366	10	1	51
677-13	7314150362493	366	10	1	51
677-3/8	7314150362509	366	10	1	51
677-7	7314150362455	366	10	1	51
677-8	7314150362462	366	10	1	51
677-9	7314150362479	366	10	1	51
679-1/2	7314150363384	366	10	1	55
679-10	7314150357345	366	10	1	55
679-11	7314150357352	366	10	1	55
679-12	7314150357369	366	10	1	55
679-13	7314150357376	366	10	1	55
679-14	7314150357383	366	10	1	55
679-3/8	7314150363360	366	10	1	55
679-7	7314150357536	366	10	1	55
679-7/16	7314150363377	366	10	1	55
679-8	7314150357079	366	10	1	55
679-9	7314150357338	366	10	1	55
679-9/16	7314150363391	366	10	1	55
6821NZ	7314151089269	354	25	1	73
6852-5	7314150125463	360	10	1	121
6852-5/S17	7314150135875	360	10	1	121
6852P-5	7314150416585	360	10	1	122
6876N	7314151845575	360	25	1	122
6878N	7314151845582	360	25	1	122
6880N	7314151845599	360	25	1	122
690000160	8413345008068	338	20	1	547
690000200	8413345008082	338	20	1	547
690000220	8413345008099	338	20	1	547
690000250	8413345008105	338	20	1	547
690000300	8413345008129	338	20	1	547
690000320	8413345008167	338	20	1	547
690000350	8413345008136	338	20	1	547
690000400	8413345008143	338	20	1	547
690000500	8413345008167	338	20	1	547
690000630	8413345111065	338	20	1	547
69079019P	8413345111089	338	20	1	547
690900080	8413345016209	338	20	1	547
690900100	8413345016216	338	20	1	547
690900120	8413345016223	338	20	1	547
690900140	8413345016230	338	20	1	547
690900200	8413345016247	338	20	1	547
6950	7314151089641	354	20	1	69
6950-SPARE	7314150187867	354	20	1	69
6950RN	7314151831189	354	20	1	69
6950RN-SPARE	7314150209149	354	20	1	69
6950SL	7314150197668	354	20	1	69
6950SL-SPARE	7314150210251	354	20	1	68
6951	7314151089764	354	20	1	69
6952N	7314150339846	354	15	1	65
6954	7314151089795	354	15	1	66
6956	7314151089825	354	15	1	66
6958	7314151089849	354	15	1	66
6960	7314151089856	354	15	1	66
6960-W	7314153010506	354	15	1	66
6961	7314151089870	354	15	1	66
6962	7314151089894	354	15	1	66
6962-W	7314153010520	354	15	1	66
6962L	7314151089917	354	15	1	66
6963	7314151089931	354	15	1	66
6966	7314151089986	354	15	1	66
6968	7314150128426	354	15	1	66
696EX-01	7314150386192	354	15	1	66
696EX-02	7314150386215	354	15	1	66
696EX-04	7314150386222	354	15	1	66
696EX-06	7314150386239	354	15	1	66
696EX-08	7314150386246	354	15	1	66
696EX-11	7314150386208	354	15	1	66
6972H	7314151215934	354	15	5	67
6973A	7314150339495	354	15	1	67
6973M	7314150339501	354	15	1	67
6973N	7314151845605	360	25	1	121
6976N	7314151845612	360	25	1	121
6978N	7314151845629	360	25	1	121
6M-10-11	7314151832094	366	10	10	49
6M-10-13	7314151832117	366	10	10	49
6M-12-13	7314151832131	366	10	10	49
6M-12-14	7314151832148	366	10	10	49
6M-13-14	7314151832155	366	10	10	49
6M-13-15	7314151832162	366	10	10	49
6M-13-16	7314151832179	366	10	10	49
6M-13-17	7314151832186	366	10	10	49
6M-14-15	7314151832193	366	10	10	49
6M-14-17	7314151832209	366	10	10	49
6M-16-17	7314151832216	366	10	10	49
6M-16-18					



CUENTA SUBGRUPO



6M-22-24	7314151832308	366	10	10	49
6M-24-26	7314151832315	366	10	10	49
6M-24-27	7314151832322	366	10	10	49
6M-24-30	7314151832339	366	10	5	49
6M-25-28	7314151832353	366	10	5	49
6M-27-29	7314150189861	366	10	5	49
6M-27-30	7314151832360	366	10	5	49
6M-27-32	7314151832377	366	10	5	49
6M-30-32	7314151832384	366	10	5	49
6M-30-36	7314151832407	366	10	5	49
6M-32-36	7314151832414	366	10	5	49
6M-34-36	7314151832421	366	10	1	49
6M-36-41	7314151832438	366	10	1	49
6M-38-42	7314151832445	366	10	1	49
6M-4-5	7314151832018	366	10	10	49
6M-4.5-5.5	7314151832025	366	10	10	49
6M-41-46	7314151832452	366	10	1	49
6M-46-50	7314151832469	366	10	1	49
6M-5-5.5	7314151832032	366	10	10	49
6M-5-5.7	7314151832049	366	10	10	49
6M-6-7	7314151832056	366	10	10	49
6M-7-8	7314151832063	366	10	10	49
6M-8-10	7314151832087	366	10	10	49
6M-8-9	7314151832070	366	10	10	49
6M/10C	7314150212934	366	10	1	50
6M/12C	7314150212941	366	10	1	51
6M/6C	7314150212910	366	10	1	50
6M/8C	7314150212927	366	10	1	50
6M/S8	7314151832483	366	10	1	50
6M/SH12	73141503013439	366	10	1	50
6M/SH8	7314150201365	366	10	1	50
6MV-10	7314150120871	366	35	5	443
6MV-11	7314150120888	366	35	5	443
6MV-12	7314150120895	366	35	5	443
6MV-13	7314150120901	366	35	5	443
6MV-14	7314150120918	366	35	5	443
6MV-15	7314150120925	366	35	5	443
6MV-16	7314150120932	366	35	5	443
6MV-17	7314150120949	366	35	3	443
6MV-18	7314150120956	366	35	3	443
6MV-19	7314150120963	366	35	3	443
6MV-20	7314150120970	366	35	3	443
6MV-21	7314150120987	366	35	3	443
6MV-22	7314150120994	366	35	3	443
6MV-23	7314150121007	366	35	3	443
6MV-24	7314150121014	366	35	3	443
6MV-27	7314150121021	366	35	2	443
6MV-30	7314150121038	366	35	2	443
6MV-32	7314150121052	366	35	2	443
6MV-6	7314150120833	366	35	5	443
6MV-7	7314150120840	366	35	5	443
6MV-8	7314150120857	366	35	5	443
6MV-9	7314150120864	366	35	5	443
6MV/10T	7314150213023	366	35	1	445
6MV/8T	7314150122141	366	35	1	445
6Z-1-1.1/8	7314151832674	366	10	1	49
6Z-1.1/16-1.1/4	7314151832681	366	10	1	49
6Z-1.1/4-1.3/8	7314151832698	366	10	1	49
6Z-1/2-9/16	7314151832568	366	10	5	49
6Z-1/4-5/16	7314151832520	366	10	5	49
6Z-11/16-3/4	7314151832612	366	10	5	49
6Z-13/16-7/8	7314151832643	366	10	5	49
6Z-15/16-1	7314151832667	366	10	5	49
6Z-19/32-11/16	7314151832582	366	10	5	49
6Z-25/32-13/16	7314151832636	366	10	5	49
6Z-3/4-7/8	7314151832629	366	10	5	49
6Z-3/8-7/16	7314151832544	366	10	5	49
6Z-5/16-11/32	7314151832537	366	10	5	49
6Z-5/8-3/4	7314151832605	366	10	5	49
6Z-7/16-1/2	7314151832551	366	10	5	49
6Z-7/8-15/16	7314151832650	366	10	5	49
6Z-9/16-5/8	7314151832575	366	10	5	49
6Z/8C	7314150212958	366	10	1	51
700-1-50	7314153017673	350	40	5	191
700-1.2-50	7314153017680	350	40	5	191
700-1.5-50	7314153017697	350	40	5	191
700-1.8-50	7314153017703	350	40	5	191
700-2-50	7314153017710	350	40	5	191
700-2.5-50	7314153017741	350	40	5	191
700-3-100	7314153017772	350	40	5	191
700-3-200	7314153017789	350	40	5	191
700-3-50	7314153017765	350	40	5	191
700-3.5-75	7314153017796	350	40	5	191
700-4-250	7314153017819	350	40	5	191
700-4-75	7314153017802	350	40	5	191
701-0-200	7314153017857	350	40	5	191
701-0-50	7314153017840	350	40	5	191
701-00-50	7314153017833	350	40	5	191
701-1-250	7314153017871	350	40	5	191
701-1-75	7314153017864	350	40	5	191
702-0-50	7314153017888	350	40	5	191
702-1-75	7314153017895	350	40	5	191
703-10-50	7314153017963	350	40	5	191
703-15-75	7314153017970	350	40	5	191
703-20-75	7314153017987	350	40	5	191
703-4-50	7314153017901	350	40	5	191
703-5-50	7314153017918	350	40	5	191
703-6-50	7314153017925	350	40	5	191



CUENTA SUBGRUPO



703-7-50	7314153017932	350	40	5	191
703-8-50	7314153017949	350	40	5	191
703-9-50	7314153017956	350	40	5	191
704-1.5-50	7314153017994	350	40	5	192
704-2-50	7314153018007	350	40	5	192
704-2.5-50	7314153018014	350	40	5	192
704-3-75	7314153018021	350	40	5	192
704Z-3/32	7314150137428	350	40	5	192
706-1	7314153018045	350	40	1	192
706-2	7314153018052	350	40	1	192
706-3	7314153018069	350	40	1	192
706-4	7314153018076	350	40	1	192
706-5	7314153018083	350	40	1	193
70S/1.2-8.0	7314150218387	346	50	1	158
70S/1.2-8.0-2P	7314150262823	346	50	25	158
70S/1.6-10.0	7314150218394	346	50	1	158
70S/1.6-10.0-2P	7314150261017	346	50	25	158
70S/1.6-9.0	7314150218400	346	50	1	158
70S/1.6-9.0-2P	7314150261024	346	50	25	158
70S/2.0-12.0	7314150218417	346	50	1	158
70S/2.0-12.0-2P	7314150261086	346	50	25	158
70S/2.5-14.0	7314150218424	346	50	1	158
70S/2.5-14.0-2P	7314150261147	346	50	25	158
70S/H10	7314150218486	346	50	1	158
70S/H10-2P	7314150261451	346	50	25	158
70S/H12	7314150218493	346	50	1	158
70S/H12-2P	7314150261468	346	50	25	158
70S/H14	7314150218509	346	50	1	158
70S/H14-2P	7314150261475	346	50	25	158
70S/H4	7314150218431	346	50	1	158
70S/H4-2P	7314150261352	346	50	25	158
70S/H5	7314150218448	346	50	1	158
70S/H5-2P	7314150261406	346	50	25	158
70S/H6	7314150218455	346	50	1	158
70S/H6-2P	7314150261437	346	50	25	158
70S/H7	7314150218462	346	50	1	158
70S/H7-2P	7314150261444	346	50	25	158
70S/H8	7314150218479	346	50	1	158
70S/H8-2P	7314150262847	346	50	25	158
70S/PH1	7314150217557	346	50	1	158
70S/PH1-2P	7314150260621	346	50	25	158
70S/PH2	7314150217564	346	50	1	158
70S/PH2-2P	7314150260638	346	50	25	158
70S/PH3	7314150217571	346	50	1	158
70S/PH3-2P	7314150260645	346	50	25	158
70S/PH4	7314150217588	346	50	1	158
70S/PH4-2P	7314150260652	346	50	25	158
70S/PZ1	7314150217595	346	50	1	158
70S/PZ1-2P	7314150260683	346	50	25	158
70S/PZ2	7314150217601	346	50	1	158
70S/PZ2-2P	7314150260706	346	50	25	158
70S/PZ3	7314150217724	346	50	1	158
70S/PZ3-2P	7314150260720	346	50	25	158
70S/PZ4	7314150217731	346	50	1	158
70S/PZ4-2P	7314150260737	346	50	25	158
70S/T20	7314150217748	346	50	1	158
70S/T20-2P	7314150260744	346	50	25	158
70S/T25	7314150217755	346	50	1	158
70S/T25-2P	7314150260812	346	50	25	158
70S/T27	7314150217762	346	50	1	158
70S/T27-2P	7314150260867	346	50	25	158
70S/T30	7314150217779	346	50	1	158
70S/T30-2P	7314150260881	346	50	25	158
70S/T40	7314150217786	346	50	1	158
70S/T40-2P	7314150260898	346	50	25	158
70S/T45	7314150217793	346	50	1	158
70S/T45-2P	7314150260904	346	50	25	158
70S/T50	7314150217809	346	50	1	158
70S/T50-2P	7314150260911	346	50	25	158
70S/T55	7314150217816	346	50	1	158
70S/T55-2P	7314150260928	346	50	25	158
70S/TS1/4	7314150218349	346	50	1	158
70S/TS1/4-2P	7314150260935	346	50	25	158
70S/TS10	7314150218356	346	50	1	158
70S/TS10-2P	7314150260942	346	50	25	158
70S/TS5/16	7314150218363	346	50	1	158
70S/TS5/16-2P	7314150260959	346	50	25	158
70S/TS8	7314150218370	346	50	1	158
70S/TS8-2P	7314150260966	346	50	25	158
7106J	7314150339518	354	15	1	79
7106S	7314150339525	354	15	1	88
7190	7314150052479	340	10	10	578
7190 CO	7314150052790	340	10	10	578
7191	7314150052509	340	10	10	578
7191 CO	7314150052806	340	10	10	578
7223	7314150237722	340	75	8	225
7223D					



7290	7314150052547	340	10	10	580
7291	7314150052554	340	10	10	580
7292	7314150052578	340	10	10	581
7293	7314150052592	340	10	10	580
7372I-2-63	7314151398668	350	40	10	195
7372I-2.5-75	7314151399047	350	40	10	195
7372I-3-80	7314151341602	350	40	10	195
7400SM-10	7314151092955	354	10	5	76
7400SM-11	7314151092962	354	10	5	76
7400SM-12	7314151092979	354	10	5	76
7400SM-13	7314151092986	354	10	5	76
7400SM-14	7314151092993	354	10	5	76
7400SM-15	7314151093006	354	10	5	76
7400SM-16	7314151831127	354	10	5	76
7400SM-17	7314151093020	354	10	5	76
7400SM-18	7314151831134	354	10	5	76
7400SM-19	7314151093044	354	10	5	76
7400SM-20	7314153002570	354	10	5	76
7400SM-21	7314153002587	354	10	5	76
7400SM-22	7314153002594	354	10	5	76
7400SM-6	7314151092917	354	10	5	76
7400SM-7	7314151092924	354	10	5	76
7400SM-8	7314151092931	354	10	5	76
7400SM-9	7314151092948	354	10	5	76
7400SR/S12	7314153003294	354	25	1	84
7400SZ-1/2	7314150385942	354	10	1	76
7400SZ-1/4	7314150385959	354	10	1	76
7400SZ-11/16	7314150385966	354	10	1	76
7400SZ-11/32	7314150385973	354	10	1	76
7400SZ-13/16	7314150385980	354	10	1	76
7400SZ-3/4	7314150385997	354	10	1	76
7400SZ-3/8	7314150386000	354	10	1	76
7400SZ-5/16	7314150386017	354	10	1	76
7400SZ-5/8	7314150386024	354	10	1	76
7400SZ-7/16	7314150386031	354	10	1	76
7400SZ-7/8	7314150386048	354	10	1	76
7400SZ-9/16	7314150386055	354	10	1	76
7400TORX-E10	7314153003058	354	10	5	77
7400TORX-E11	7314153003065	354	10	5	77
7400TORX-E12	7314153003072	354	10	5	77
7400TORX-E14	7314153003089	354	10	5	77
7400TORX-E16	7314153003096	354	10	5	77
7400TORX-E18	7314153003102	354	10	5	77
7400TORX-E8	7314150118243	354	10	5	77
7400TORX-ER/S7	7314153003300	354	25	1	85
7406ZZ-16	7314153011992	312	10	1	282
7406ZZ-21	7314153012005	312	10	1	282
7407H	7314151218249	354	35	1	104
7408H	7314151218300	354	35	1	104
7408MD	7314150220328	354	25	1	84
7409BH-10	7314153002112	354	10	5	81
7409BH-4	7314153002075	354	10	5	81
7409BH-5	7314153002082	354	10	1	81
7409BH-6	7314153002099	354	10	5	81
7409BH-8	7314153002105	354	10	5	81
7409F-10	7314153002143	354	10	5	80
7409F-6.5	7314153002129	354	10	5	80
7409F-8	7314153002136	354	10	5	80
7409H	7314151218355	354	35	1	104
7409M-10	7314153001962	354	10	5	81
7409M-3	7314153002235	354	10	5	80
7409M-4	7314153001900	354	10	5	80
7409M-5	7314153001917	354	10	5	80
7409M-6	7314153001924	354	10	5	80
7409M-7	7314153001931	354	10	5	81
7409M-8	7314153001948	354	10	5	81
7409MB	7314150220236	354	25	1	84
7409MR/S7	7314153003256	354	25	1	81
7409PH-1	7314153002150	354	10	5	80
7409PH-2	7314153002167	354	10	5	80
7409PH-3	7314153002174	354	10	5	80
7409TORX-R-T27	7314153001856	354	10	5	80
7409TORX-R-T30	7314153001863	354	10	5	80
7409TORX-R-T40	7314153001870	354	10	5	80
7409TORX-R-T45	7314153001887	354	10	5	80
7409TORX-R-T50	7314153001894	354	10	5	80
7409TORX-T20	7314150220403	354	10	5	80
7409TORX-T25	7314153001771	354	10	5	80
7409TORX-T25-L	7314153011237	354	10	5	80
7409TORX-T27	7314153001788	354	10	5	80
7409TORX-T30	7314153001795	354	10	5	80
7409TORX-T30-L	7314153011244	354	10	5	80
7409TORX-T40	7314153001801	354	10	5	80
7409TORX-T40-L	7314153011251	354	10	5	80
7409TORX-T45	7314153001818	354	10	5	80
7409TORX-T45-L	7314153011268	354	10	5	80
7409TORX-T50	7314153001825	354	10	5	80
7409TORX-T50-L	7314153011275	354	10	5	80
7409TORX-TRR/SS	7314153003263	354	25	1	80
7409Z-1/4	7314150386062	354	10	1	81
7409Z-1/8	7314150386079	354	10	1	81
7409Z-3/16	7314150386086	354	10	1	81
7409Z-3/8	7314150386093	354	10	1	81
7409Z-5/32	7314150386109	354	10	1	81
7409Z-7/32	7314150386116	354	10	1	81
7420RE	7314153014962	354	25	1	82
7422MBR	7314150218844	354	25	1	83
7422MHR	7314150218868	354	25	1	83



7429JDE	7314153003348	354	25	1	83
7430GE	7314153014979	354	25	1	82
7440ME	7314153014986	354	25	1	81
7444SG-M-100	7314151830014	366	20	1	56
7444SG-M-105	7314151830021	366	20	1	56
7444SG-M-110	7314151830038	366	20	1	56
7444SG-M-115	7314151830045	366	20	1	56
7444SG-M-120	7314151830052	366	20	1	56
7444SG-M-125	7314151830069	366	20	1	56
7444SG-M-130	7314151830076	366	20	1	56
7444SG-M-135	7314151830083	366	20	1	56
7444SG-M-140	7314151830090	366	20	1	56
7444SG-M-145	7314151830106	366	20	1	56
7444SG-M-150	7314151830113	366	20	1	56
7444SG-M-155	7314151830120	366	20	1	56
7444SG-M-160	7314150132508	366	20	1	56
7444SG-M-165	7314150132515	366	20	1	56
7444SG-M-170	7314150132522	366	20	1	56
7444SG-M-175	7314150132539	366	20	1	56
7444SG-M-24	7314150205400	366	20	1	56
7444SG-M-27	7314151829834	366	20	1	56
7444SG-M-30	7314151829841	366	20	1	56
7444SG-M-32	7314151829858	366	20	1	56
7444SG-M-34	7314151838560	366	20	1	56
7444SG-M-36	7314151829865	366	20	1	56
7444SG-M-38	7314150180936	366	20	1	56
7444SG-M-41	7314151829872	366	20	1	56
7444SG-M-42	7314151829889	366	20	1	56
7444SG-M-46	7314151829896	366	20	1	56
7444SG-M-50	7314151829919	366	20	1	56
7444SG-M-55	7314151829926	366	20	1	56
7444SG-M-60	7314151829933	366	20	1	56
7444SG-M-65	7314151829940	366	20	1	56
7444SG-M-70	7314151829957	366	20	1	56
7444SG-M-75	7314151829964	366	20	1	56
7444SG-M-80	7314151829971	366	20	1	56
7444SG-M-85	7314151829988	366	20	1	56
7444SG-M-90	7314151829995	366	20	1	56
7444SG-M-95	7314151830007	366	20	1	56
7444SG-Z-1.1/16	7314150132546	366	20	1	56
7444SG-Z-1.1/2	7314150132614	366	20	1	56
7444SG-Z-1.1/4	7314150132577	366	20	1	56
7444SG-Z-1.1/8	7314150132553	366	20	1	56
7444SG-Z-1.11/16	7314150132638	366	20	1	56
7444SG-Z-1.13/16	7314150132652	366	20	1	56
7444SG-Z-1.3/16	7314150132560	366	20	1	56
7444SG-Z-1.3/4	7314150132645	366	20	1	56
7444SG-Z-1.3/8	7314150132591	366	20	1	56
7444SG-Z-1.5/16	7314150132584	366	20	1	56
7444SG-Z-1.5/8	7314150132621	366	20	1	56
7444SG-Z-1.7/16	7314150132607	366	20	1	56
7444SG-Z-1.7/8	7314150132669	366	20	1	56
7444SG-Z-2	7314150132676	366	20	1	56
7444SG-Z-2.1/16	7314150132683	366	20	1	56
7444SG-Z-2.1/4	7314150132713	366	20	1	56
7444SG-Z-2.1/8	7314150132690	366	20	1	56
7444SG-Z-2.3/16	7314150132706	366	20	1	56
7444SG-Z-2.3/4	7314150132768	366	20	1	56
7444SG-Z-2.3/8	7314150132720	366	20	1	56
7444SG-Z-2.5/8	7314150132751	366	20	1	56
7444SG-Z-2.9/16	7314150132744	366	20	1	56
7444SG-Z-3	7314150132775	366	20	1	56
7444SG-Z-3.1/2	7314150132805	366	20	1	56
7444SG-Z-3.1/8	7314150132782	366	20	1	56
7444SG-Z-3.3/4	7314150132812	366	20	1	56
7444SG-Z-3.3/8	7314150132799	366	20	1	56
7444SG-Z-3.7/8	7314150132829	366	20	1	56
7444SG-Z-4	7314150132836	366	20	1	56
7444SG-Z-4.1/2	7314150132850	366	20	1	56
7444SG-Z-4.1/8	7314150132843	366	20	1	56
744T00000	8413345210638	354	20	1	99
744T01190	8413345206761	354	20	1	99
7453-20-6	7314150119479	360	10	1	122
7453-20-6F	7314150119462	360	10	1	122
7454-1400	7314150119547	360	10	1	116
7454-1400E	7314150119592	360	10	1	116
7454-18	7314150119615	360	10	1	117
7454-240	7314150119516	360	10	1	116
7454-3	7314150119493	360	10	1	116
7454-35	7314150119523	360	10	1	116
7454-480	7314150119578	360	10	1	116
7454-700	7314150119530	360	10	1	116
7454-800	7314150119585	360	10	1	116
7454-800E	7314150119608	360	10	1	116
7454-9	7314150119509	360	10	1	116
7455-100	7314150125111	360	10	1	114
7455-1000	7314150368303	360	10	1	114
7455-100A	7314150340156	360	10	1	114

7455-500



CUENTA	SUBGRUPO				
7455-500	7314150125142	360	10	1	114
7455-60	7314150125098	360	10	1	114
7455-800	7314150125159	360	10	1	114
7456-80LB	7314150119783	360	10	1	115
7465-100	7314150340200	360	10	1	114
7465-15	7314150340170	360	10	1	114
7465-1500	7314150340248	360	10	1	115
7465-200	7314150340217	360	10	1	114
7465-30	7314150340187	360	10	1	114
7465-340	7314150340224	360	10	1	115
7465-5	7314150340163	360	10	1	114
7465-60	7314150340194	360	10	1	114
7465-800	7314150340231	360	10	1	115
747-1	7314150362899	366	10	1	52
747-1.1/16	7314150362905	366	10	1	52
747-1.1/2	7314150362974	366	10	1	52
747-1.1/4	7314150362936	366	10	1	52
747-1.1/8	7314150362912	366	10	1	52
747-1.11/16	7314150363001	366	10	1	52
747-1.13/16	7314150363025	366	10	1	52
747-1.15/16	7314150363049	366	10	1	52
747-1.3/16	7314150362929	366	10	1	52
747-1.3/4	7314150363018	366	10	1	52
747-1.3/8	7314150362950	366	10	1	52
747-1.5/16	7314150362943	366	10	1	52
747-1.5/8	7314150362998	366	10	1	52
747-1.7/16	7314150362967	366	10	1	52
747-1.7/8	7314150363032	366	10	1	52
747-1.9/16	7314150362981	366	10	1	52
747-1/2	7314150362813	366	10	1	52
747-10	7314150362516	366	10	1	52
747-11	7314150362523	366	10	1	52
747-11/16	7314150362844	366	10	1	52
747-12	7314150362530	366	10	1	52
747-13	7314150362547	366	10	1	52
747-13/16	7314150362868	366	10	1	52
747-14	7314150362554	366	10	1	52
747-15	7314150362561	366	10	1	52
747-15/16	7314150362882	366	10	1	52
747-16	7314150362578	366	10	1	52
747-17	7314150362585	366	10	1	52
747-18	7314150362592	366	10	1	52
747-19	7314150362608	366	10	1	52
747-2	7314150363056	366	10	1	52
747-2.1/16	7314150363063	366	10	1	52
747-2.1/2	7314150363131	366	10	1	52
747-2.1/4	7314150363094	366	10	1	52
747-2.1/8	7314150363070	366	10	1	52
747-2.3/16	7314150364893	366	10	1	52
747-2.3/4	7314150363162	366	10	1	52
747-2.3/8	7314150363117	366	10	1	52
747-2.5/16	7314150363100	366	10	1	52
747-2.5/8	7314150363155	366	10	1	52
747-2.7/16	7314150363124	366	10	1	52
747-2.7/8	7314150363179	366	10	1	52
747-2.9/16	7314150363148	366	10	1	52
747-20	7314150362615	366	10	1	52
747-21	7314150362622	366	10	1	52
747-22	7314150362639	366	10	1	52
747-23	7314150362646	366	10	1	52
747-24	7314150362653	366	10	1	52
747-25	7314150362660	366	10	1	52
747-26	7314150362677	366	10	1	52
747-27	7314150362684	366	10	1	52
747-28	7314150362691	366	10	1	52
747-3/4	7314150362851	366	10	1	52
747-3/8	7314150362790	366	10	1	52
747-30	7314150362707	366	10	1	52
747-32	7314150362714	366	10	1	52
747-34	7314150362721	366	10	1	52
747-36	7314150362738	366	10	1	52
747-40	7314150362745	366	10	1	52
747-41	7314150362752	366	10	1	52
747-42	7314150362769	366	10	1	52
747-46	7314150362776	366	10	1	52
747-5/8	7314150362837	366	10	1	52
747-50	7314150362783	366	10	1	52
747-7/16	7314150362806	366	10	1	52
747-7/8	7314150362875	366	10	1	52
747-9/16	7314150362820	366	10	1	52
749-1	7314150363506	366	10	1	56
749-1.1/16	7314150363513	366	10	1	56
749-1.1/2	7314150363582	366	10	1	56
749-1.1/4	7314150363544	366	10	1	56
749-1.1/8	7314150363520	366	10	1	56
749-1.11/16	7314150363612	366	10	1	56
749-1.13/16	7314150363636	366	10	1	56
749-1.15/16	7314150363650	366	10	1	56
749-1.3/16	7314150363537	366	10	1	56
749-1.3/4	7314150363629	366	10	1	56
749-1.3/8	7314150363568	366	10	1	56
749-1.5/16	7314150363551	366	10	1	56
749-1.5/8	7314150363605	366	10	1	56
749-1.7/16	7314150363575	366	10	1	56
749-1.7/8	7314150363643	366	10	1	56
749-1.9/16	7314150363599	366	10	1	56
749-1/2	7314150363421	366	10	1	56
749-11/16	7314150363452	366	10	1	56



749-13/16	7314150363476	366	10	1	56
749-15	7314150357543	366	10	1	55
749-15/16	7314150363490	366	10	1	56
749-16	7314150357550	366	10	1	55
749-17	7314150357567	366	10	1	55
749-18	7314150357574	366	10	1	55
749-19	7314150357581	366	10	1	55
749-2	7314150363667	366	10	1	56
749-2.1/4	7314150363698	366	10	1	56
749-2.1/8	7314150363674	366	10	1	56
749-2.3/16	7314150363681	366	10	1	56
749-2.3/4	7314150363728	366	10	1	56
749-2.3/8	7314150363704	366	10	1	56
749-2.5/8	7314150363711	366	10	1	56
749-20	7314150357598	366	10	1	55
749-21	7314150357604	366	10	1	55
749-22	7314150357611	366	10	1	55
749-23	7314150357628	366	10	1	55
749-24	7314150357635	366	10	1	55
749-25	7314150357642	366	10	1	55
749-26	7314150357659	366	10	1	55
749-27	7314150357666	366	10	1	55
749-3.1/8	7314150363735	366	10	1	56
749-3/4	7314150363469	366	10	1	56
749-3/8	7314150363407	366	10	1	55
749-5/8	7314150363445	366	10	1	56
749-7/16	7314150363414	366	10	1	56
749-7/8	7314150363483	366	10	1	56
749-9/16	7314150363438	366	10	1	56
7490	7314150052646	340	10	10	580
7490 CO	7314150052875	340	10	10	580
74P14-200	7314150416318	360	10	1	118
74P14-300	7314150416325	360	10	1	118
74P14-400	7314150416332	360	10	1	118
74P9-100	7314150416301	360	10	1	118
74P9-20	7314150416288	360	10	1	117
74P9-60	7314150416295	360	10	1	118
74PR-100	7314150416189	360	10	1	117
74PR-100A	7314150416196	360	10	1	117
74PR-20	7314150416158	360	10	1	117
74PR-200	7314150416202	360	10	1	117
74PR-300	7314150416219	360	10	1	117
74PR-400	7314150416226	360	10	1	117
74PR-60	7314150416165	360	10	1	117
74PR-60A	7314150416172	360	10	1	117
74PS-100	7314150416257	360	10	1	117
74PS-20	7314150416233	360	10	1	117
74PS-200	7314150416264	360	10	1	117
74PS-300	7314150416271	360	10	1	117
74PS-60	7314150416240	360	10	1	117
74S/H10	7314150218622	346	50	1	159
74S/H10-2P	7314150261635	346	50	25	159
74S/H12	7314150218639	346	50	1	159
74S/H12-2P	7314150261659	346	50	25	159
74S/H14	7314150218646	346	50	1	159
74S/H14-2P	7314150261666	346	50	1	159
74S/H17	7314150218653	346	50	1	159
74S/H17-2P	7314150261673	346	50	25	159
74S/H4	7314150218578	346	50	1	158
74S/H4-2P	7314150261543	346	50	25	158
74S/H5	7314150218585	346	50	1	159
74S/H5-2P	7314150261550	346	50	25	159
74S/H6	7314150218592	346	50	1	159
74S/H6-2P	7314150261567	346	50	25	159
74S/H7	7314150218608	346	50	1	159
74S/H7-2P	7314150261574	346	50	25	159
74S/H8	7314150218615	346	50	1	159
74S/H8-2P	7314150261611	346	50	25	159
74W14-200	7314150415700	360	10	1	116
74W14-300	7314150415717	360	10	1	116
74W14-400	7314150415724	360	10	1	116
74W9-100	7314150415687	360	10	1	116
74W9-15	7314150415656	360	10	1	116
74W9-200	7314150415694	360	10	1	116
74W9-25	7314150415663	360	10	1	116
74W9-50	7314150415670	360	10	1	116
74WR-100	7314150415540	360	10	1	115
74WR-15	7314150415519	360	10	1	115
74WR-200	7314150415557	360	10	1	115
74WR-25	7314150415526	360	10	1	115
74WR-300	7314150415564	360	10	1	115
74WR-340	7314150415571	360	10	1	115
74WR-400	7314150415588	360	10	1	115
74WR-50	7314150415533	360	10	1	115
74WS-100	7314150415625	360	10	1	116
74WS-15	7314150415595	360	10	1	116
74WS-200	7314150415632	360	10	1	116
74WS-25	7314150415601	360	10	1	116
74WS-300	7314150415649	360	10	1	116
74WS-50	7314150415618	360	10	1	116
7590	7314150052660	340	10	1	580
7590 CO	7314150052882</				



CUENTA SUBGRUPO



75R1-1500	7314150415236	360	10	1	114
75R3-1000	7314150415229	360	10	1	114
75R3-650	7314150415205	360	10	1	114
75R3-800	7314150415212	360	10	1	114
75S-650	7314150415243	360	10	1	114
76R3-1000	7314150422128	360	10	1	115
76R3-600	7314150423118	360	10	1	115
76R3-800	7314150422111	360	10	1	115
76S-600	7314150423125	360	10	1	115
7710	7314151551445	354	20	1	80
7710-SO/1	7314151809744	354	20	1	81
7750	7314151096427	354	20	1	79
7750-SPARE	7314150187874	354	20	1	81
7750RN	7314151831240	354	20	1	79
7750RN-SPARE	7314150209361	354	20	1	81
7750SL	7314150197675	354	20	1	79
7750SL-SPARE	7314150210268	354	20	1	81
7751	7314150386949	354	20	10	81
7752	7314151096533	354	15	1	77
7754	7314151096557	354	15	1	77
7755-3/8	7314153002372	354	20	1	79
7755-SO/1	7314153010728	354	20	1	81
7757	7314151096588	354	15	1	78
7758	7314151096595	354	15	1	77
7759	7314151096601	354	15	1	78
7760	7314151096618	354	15	1	78
7760-W	7314150107155	354	15	1	78
7761	7314151096632	354	15	1	78
7761-W	7314150107162	354	15	1	78
7762	7314151096649	354	15	1	78
7764	7314151096670	354	15	1	78
7765	7314151096687	354	15	1	66
7766	7314151096694	354	15	1	78
7767	7314153003577	354	15	1	67
7768	7314150128433	354	15	1	78
776EX-01	7314150386130	354	15	1	78
776EX-03	7314150386154	354	15	1	78
776EX-04	7314150386161	354	15	1	78
776EX-06	7314150386178	354	15	1	78
776EX-08	7314150386185	354	15	1	78
776EX-11	7314150386147	354	15	1	78
7800DM-10	7314151096991	354	10	1	86
7800DM-11	7314151097011	354	10	1	86
7800DM-12	7314151097035	354	10	1	86
7800DM-13	7314151097059	354	10	1	86
7800DM-14	7314151097073	354	10	1	86
7800DM-15	7314151097097	354	10	1	86
7800DM-16	7314151097110	354	10	1	86
7800DM-17	7314151097134	354	10	1	86
7800DM-18	7314151097158	354	10	1	86
7800DM-19	7314151097172	354	10	1	86
7800DM-20	7314151097196	354	10	1	86
7800DM-21	7314151097219	354	10	1	86
7800DM-22	7314151097233	354	10	1	86
7800DM-23	7314151097257	354	10	1	86
7800DM-24	7314151097271	354	10	1	86
7800DM-25	7314151097295	354	10	1	86
7800DM-26	7314151097318	354	10	1	86
7800DM-27	7314151097332	354	10	1	86
7800DM-28	7314151097356	354	10	1	86
7800DM-29	7314151097363	354	10	1	86
7800DM-30	7314151097370	354	10	1	86
7800DM-32	7314151097387	354	10	1	86
7800DM-33	7314150169351	354	10	1	86
7800DM-34	7314150169405	354	10	1	86
7800DM-36	7314151097400	354	10	1	86
7800DM-8	7314151830854	354	10	1	86
7800DM-9	7314151830861	354	10	1	86
7800DMV-10	7314150121656	354	40	10	443
7800DMV-11	7314150121663	354	40	10	443
7800DMV-12	7314150121670	354	40	10	443
7800DMV-13	7314150121687	354	40	10	443
7800DMV-14	7314150121694	354	40	10	443
7800DMV-15	7314150121700	354	40	10	443
7800DMV-16	7314150121717	354	40	10	443
7800DMV-17	7314150121724	354	40	10	443
7800DMV-18	7314150121731	354	40	10	443
7800DMV-19	7314150121748	354	40	10	443
7800DMV-20	7314150121755	354	40	10	443
7800DMV-21	7314150121762	354	40	10	443
7800DMV-22	7314150121779	354	40	10	443
7800DMV-24	7314150121786	354	40	5	443
7800DMV-27	7314150121793	354	40	5	443
7800DMV-30	7314150121809	354	40	5	443
7800DMV-32	7314150121816	354	40	5	443
7800DMV-8	7314150121649	354	40	10	443
7800DZ-1	7314151097561	354	10	1	86
7800DZ-1.1/16	7314151097578	354	10	1	86
7800DZ-1.1/4	7314151097608	354	10	1	86
7800DZ-1.1/8	7314151097585	354	10	1	86
7800DZ-1.3/16	7314151097592	354	10	1	86
7800DZ-1.5/16	7314150166077	354	10	1	86
7800DZ-1/2	7314151097455	354	10	1	86
7800DZ-11/16	7314151097493	354	10	1	86
7800DZ-13/16	7314151097523	354	10	1	86
7800DZ-15/16	7314151097554	354	10	1	86
7800DZ-19/32	7314151097479	354	10	1	86
7800DZ-25/32	7314151097516	354	10	1	86



CUENTA SUBGRUPO



7800DZ-3/4	7314151097509	354	10	1	86
7800DZ-3/8	7314151097431	354	10	1	86
7800DZ-5/8	7314151097486	354	10	1	86
7800DZ-7/16	7314151097448	354	10	1	86
7800DZ-7/8	7314151097530	354	10	1	86
7800DZ-9/16	7314151097462	354	10	1	86
7800SM-10	7314151097851	354	10	1	85
7800SM-11	7314151097868	354	10	1	85
7800SM-12	7314151097875	354	10	1	85
7800SM-13	7314151097882	354	10	1	85
7800SM-14	7314151097899	354	10	1	85
7800SM-15	7314151097905	354	10	1	85
7800SM-16	7314151097912	354	10	1	85
7800SM-17	7314151097929	354	10	1	85
7800SM-18	7314151097936	354	10	1	85
7800SM-19	7314151097943	354	10	1	85
7800SM-20	7314150166206	354	10	1	85
7800SM-21	7314151097967	354	10	1	85
7800SM-22	7314151097974	354	10	1	85
7800SM-23	7314151097981	354	10	1	85
7800SM-24	7314151097998	354	10	1	85
7800SM-25	7314151098001	354	10	1	85
7800SM-26	7314151830823	354	10	1	85
7800SM-27	7314151098025	354	10	1	85
7800SM-28	7314151830830	354	10	1	85
7800SM-29	7314150166213	354	10	1	85
7800SM-30	7314151098056	354	10	1	85
7800SM-32	7314151098063	354	10	1	85
7800SM-33	7314150167319	354	10	1	85
7800SM-34	7314153011305	354	10	1	85
7800SM-36	7314151098087	354	10	1	85
7800SM-8	7314151830793	354	10	1	85
7800SM-9	7314151830809	354	10	1	85
7800TORX-E10	7314150166084	354	10	1	87
7800TORX-E11	7314150220359	354	10	1	87
7800TORX-E12	7314153011800	354	10	1	87
7800TORX-E14	7314153011756	354	10	1	87
7800TORX-E16	7314153011763	354	10	1	87
7800TORX-E18	7314153011770	354	10	1	87
7800TORX-E20	7314153011787	354	10	1	87
7800TORX-E24	7314153011794	354	10	1	87
7800TORX-E8	7314150166091	354	10	1	87
7805DM-10	7314151822101	354	10	1	86
7805DM-12	7314151098452	354	10	1	86
7805DM-13	7314151098469	354	10	1	86
7805DM-14	7314151098476	354	10	1	86
7805DM-15	7314151098483	354	10	1	86
7805DM-16	7314151098490	354	10	1	86
7805DM-17	7314151098506	354	10	1	86
7805DM-18	7314151098513	354	10	1	86
7805DM-19	7314151098520	354	10	1	86
7805DM-21	7314151098544	354	10	1	86
7805DM-22	7314151098551	354	10	1	86
7805DM-23	7314150313532	354	10	1	86
7805DM-24	7314151098568	354	10	1	86
7805DM-26	7314151098582	354	10	1	86
7805DM-27	7314151098599	354	10	1	86
7805DM-30	7314151098605	354	10	1	86
7805DM-32	7314150220281	354	10	1	86
7805DZ-1	7314150357758	354	10	1	86
7805DZ-1.1/16	7314150357765	354	10	1	86
7805DZ-1.1/2	7314150357833	354	10	1	86
7805DZ-1.1/4	7314150357796	354	10	1	86
7805DZ-1.1/8	7314150357772	354	10	1	86
7805DZ-1.3/16	7314150357789	354	10	1	86
7805DZ-1.3/8	7314150357819	354	10	1	86
7805DZ-1.5/16	7314150357802	354	10	1	86
7805DZ-1.7/16	7314150357826	354	10	1	86
7805DZ-11/16	7314150357703	354	10	1	86
7805DZ-13/16	7314150357727	354	10	1	86
7805DZ-15/16	7314150357741	354	10	1	86
7805DZ-3/4	7314150357710	354	10	1	86
7805DZ-5/8	7314150357697	354	10	1	86
7805DZ-7/8	7314150357734	354	10	1	86
7805SM-10	7314153011312	354	10	1	85
7805SM-12	7314153011329	354	10	1	85
7805SM-13	7314153011336	354	10	1	85
7805SM-14	7314153011343	354	10	1	85
7805SM-15	7314153011350	354	10	1	85
7805SM-16	7314153011367	354	10	1	85
7805SM-17	7314153011374	354	10	1	85
7805SM-18	7314153011381	354	10	1	85
7805SM-19	7314153011398	354	10	1	85
7805SM-20	7314153011404	354	10	1	85
7805SM-21	7314153011411	354	10	1	85
7805SM-22	7314153011428	354	10	1	85
7805SM-23	7314153011435	354	10	1	85
7805SM-24	73141530114				

7805SZ-1.3/8



CUENTA	SUBGRUPO				
7805SZ-1.3/8	7314150357963	354	10	1	85
7805SZ-1.5/16	7314150357956	354	10	1	85
7805SZ-1.7/16	7314150357970	354	10	1	85
7805ZZ-16	7314151822767	312	10	1	282
7805ZZ-21	7314151347338	312	10	1	282
7806	7314153012012	312	30	1	290
7806MD	7314150220335	354	25	1	97
7807	7314153012029	312	30	1	282
7807H	7314151232764	354	35	1	106
7807TE	7314150313792	354	25	1	97
7808H	7314151232771	354	35	1	106
7808HM	7314150220434	354	10	1	89
7809F-10	7314151830892	354	10	5	88
7809F-8	7314151830885	354	10	5	88
7809H	7314151232788	354	35	1	106
7809HL	7314150128464	354	15	1	88
7809M-10	7314151815608	354	10	1	89
7809M-10-140	7314151831011	354	10	1	90
7809M-12	7314151815615	354	10	1	89
7809M-14	7314151815622	354	10	1	89
7809M-17	7314151831028	354	10	1	89
7809M-19	7314151831035	354	10	1	89
7809M-4	7314150214600	354	10	1	89
7809M-5	7314151815561	354	10	1	89
7809M-5-100	7314150313761	354	10	1	90
7809M-5-180	7314151830922	354	10	1	90
7809M-6	7314151815578	354	10	1	89
7809M-6-100	7314150313778	354	10	1	90
7809M-6-140	7314151830946	354	10	1	90
7809M-7	7314151815585	354	10	1	89
7809M-7-100	7314151830960	354	10	1	90
7809M-8	7314151815592	354	10	1	89
7809M-8-120	7314151830984	354	10	1	90
7809M-9	7314151830991	354	10	1	89
7809M/10	7314151831448	354	25	1	92
7809PH-2	7314151830908	354	10	1	88
7809PH-3	7314151830915	354	10	1	88
7809PH-4	7314153003423	354	10	1	88
7809PZ-2	7314153003430	354	10	1	89
7809PZ-3	7314153003447	354	10	1	89
7809TO	7314150220465	354	10	1	89
7809TORX-T20	7314151811730	354	10	1	89
7809TORX-T25	7314151811747	354	10	1	89
7809TORX-T27	7314151811754	354	10	1	89
7809TORX-T30	7314151811761	354	10	1	89
7809TORX-T40	7314151811778	354	10	1	89
7809TORX-T40-120	7314150220564	354	10	5	89
7809TORX-T45	7314151811785	354	10	1	89
7809TORX-T45-120	7314150220557	354	10	1	89
7809TORX-T50	7314151811792	354	10	1	89
7809TORX-T50-100	7314150220540	354	10	5	89
7809TORX-T55	7314151811808	354	10	1	89
7809TORX-T55-140	7314150220533	354	10	5	89
7809TORX-T60	7314151811815	354	10	1	89
7809TORX-T70-140	7314150220526	354	10	5	89
7809TORX/10	7314151831455	354	25	1	92
7809XZN-10	7314151831080	354	10	1	89
7809XZN-10-100	7314151831097	354	10	1	89
7809XZN-12	7314151831103	354	10	1	89
7809XZN-12-100	7314151831110	354	10	1	89
7809XZN-14	7314153004574	354	10	1	89
7809XZN-14-100	7314153004567	354	10	1	89
7809XZN-16	7314150220458	354	10	1	89
7809XZN-18	7314150314058	354	10	1	89
7809XZN-6	7314150214617	354	10	1	89
7809XZN-8	7314151831066	354	10	1	89
7809XZN-8-100	7314151831073	354	10	1	89
7809Z-1/2	7314153003515	354	10	1	89
7809Z-1/4	7314153003478	354	10	1	89
7809Z-17/32	7314150313785	354	10	1	89
7809Z-19/32	7314153003546	354	10	1	89
7809Z-3/16	7314153003461	354	10	1	89
7809Z-3/8	7314153003492	354	10	1	89
7809Z-5/16	7314153003485	354	10	1	89
7809Z-5/8	7314153003553	354	10	1	89
7809Z-7/16	7314153003508	354	10	1	89
7809Z-9/16	7314153003539	354	10	1	89
7809Z/10	7314153003560	354	25	1	92
7810MB	7314150220380	354	25	1	96
7810MH	7314150220373	354	25	1	96
7811DMV	7314150122134	354	40	1	416
7814DS	7314150318964	354	25	1	92
7814DST	7314150319022	354	25	1	94
7817DZS	7314150319008	354	25	1	94
7818DS	7314150318971	354	25	1	92
7818DST	7314150319039	354	25	1	94
7818MHR	7314150218912	354	25	1	93
7818SST	7314150319046	354	25	1	94
7819DRN	7314151831547	354	25	1	93
7819SRE	7314151837921	354	25	1	92
782-J	7311518276447	312	25	1	284
7823	7314150218141	346	50	16	159
7823DET	7314150319084	354	25	1	95
7823DZS	7314150319015	354	25	1	94
7823SE	7314150318988	354	25	1	93
7825DST	7314150319060	354	25	1	95
7825MBP	7314150218929	354	25	1	93
7825MHP	7314150218943	354	25	1	93



CUENTA	SUBGRUPO				
7825SST	7314150319053	354	25	1	95
7827DST	7314150319077	354	25	1	95
783	7311518276034	312	25	1	284
7835 G-160	7314150050253	340	55	5	223
7847SS	7314150318995	354	25	1	94
7851-G	7314150124909	360	10	1	120
7851-M	7314150124893	360	10	1	120
7865	7311518276720	346	50	1	159
787-1.1/16	7314150363186	366	10	1	52
787-1.1/2	7314150363254	366	10	1	52
787-1.1/4	7314150363216	366	10	1	52
787-1.1/8	7314150363193	366	10	1	52
787-1.11/16	7314150363278	366	10	1	52
787-1.13/16	7314150363292	366	10	1	52
787-1.3/16	7314150363209	366	10	1	52
787-1.3/4	7314150363285	366	10	1	52
787-1.3/8	7314150363230	366	10	1	52
787-1.5/16	7314150363223	366	10	1	52
787-1.5/8	7314150363261	366	10	1	52
787-1.7/16	7314150363247	366	10	1	52
787-1.7/8	7314150363308	366	10	1	52
787-2	7314150363315	366	10	1	52
787-2.1/4	7314150363346	366	10	1	52
787-2.1/8	7314150363322	366	10	1	52
787-2.3/16	7314150363339	366	10	1	52
787-2.3/8	7314150363353	366	10	1	52
78802B	7314150391769	350	46	1	193
7888DM	7314151820923	354	25	1	93
789-1.1/2	7314150363896	366	10	1	56
789-1.1/4	7314150363858	366	10	1	56
789-1.1/8	7314150363841	366	10	1	56
789-1.13/16	7314150363933	366	10	1	56
789-1.3/4	7314150363926	366	10	1	56
789-1.3/8	7314150363872	366	10	1	56
789-1.5/16	7314150363865	366	10	1	56
789-1.5/8	7314150363919	366	10	1	56
789-1.7/16	7314150363889	366	10	1	56
789-1.9/16	7314150363902	366	10	1	56
789-2	7314150363940	366	10	1	56
789-2.1/4	7314150363957	366	10	1	56
789-2.3/8	7314150363971	366	10	1	56
789-2.5/16	7314150363964	366	10	1	56
789-28	7314150363742	366	10	1	56
789-30	7314150363759	366	10	1	56
789-32	7314150357673	366	10	1	56
789-34	7314150363766	366	10	1	56
789-36	7314150363773	366	10	1	56
789-38	7314150363780	366	10	1	56
789-40	7314150363797	366	10	1	56
789-41	7314150363803	366	10	1	56
789-42	7314150363810	366	10	1	56
789-46	7314150363827	366	10	1	56
789-50	7314150363834	366	10	1	56
7890	7314150052691	340	10	10	580
7890 CO	7314150052899	340	10	10	580
7891	7314150052714	340	10	10	580
7891 CO	7314150052905	340	10	10	580
7892	7314150052738	340	10	10	581
7893	7314150052769	340	10	10	581
790450A	7314150214716	340	25	1	240
790455A	7314150214709	340	25	1	241
7993M0170	8413345115353	354	30	1	110
7993M0190	8413345115377	354	30	1	110
7993M0220	8413345115391	354	30	1	110
7993M0270	8413345115414	354	30	1	110
7993S0050	8413345115070	354	30	1	106
7993S0060	8413345115094	354	30	1	106
7993S0080	8413345115117	354	30	1	106
7993S0100	8413345115131	354	30	1	106
7993S0120	8413345115155	354	30	1	106
7993S0140	8413345115179	354	30	1	106
7993S0170	8413345115193	354	30	1	106
7993S0190	8413345115216	354	30	1	106
7993T0120	8413345115230	354	30	1	108
7993T0140	8413345115254	354	30	1	108
7993T0170	8413345115278	354	30	1	109
7993T0190	8413345115292	354	30	1	109
7993T0220	8413345115315	354	30	1	109
7993T0240	8413345115339	354	30	1	109
7994S0300	8413345129305	354	30	1	106
7994S0400	8413345129312	354	30	1	106
7994S0450	8413345129329	354	30	1	106
7994S0500	8413345129336	354	30	1	106
7994S0550	8413345129343	354	30	1	106
7994S0600	8413345129350	354	30	1	106
8010SL-2P	7314150243853	350	38	1	439
8020-2P	7314150246601	350	10	1	189
8030-2P	7314150246618	350	10	1	189
8040-2P	7314150246625	350	10	1	189
8040L-2P	73141502466				



CUENTA	SUBGRUPO				
8060B0080	8413345018104	338	10	1	245
8060B0100	8413345018111	338	10	1	245
8060B0120	8413345018128	338	10	1	245
8060B0140	8413345018135	338	10	1	245
8060B0180	8413345018142	338	10	1	245
8060B0240	8413345018159	338	10	1	245
8060B0360	8413345018166	338	10	1	245
8060T0080	8413345018173	338	10	1	245
8060T0100	8413345018180	338	10	1	245
8060T0120	8413345018197	338	10	1	245
8060T0140	8413345018203	338	10	1	245
8060T0180	8413345018210	338	10	1	245
8060T0240	8413345018227	338	10	1	245
8060T0360	8413345018234	338	10	1	245
8069	7314150007028	310	10	5	39
8069 C	7314150007035	310	10	5	39
8069 C IP	7314150101634	310	10	5	39
8069 IP	7314150007042	310	10	50	39
8069-1	7314150239511	310	10	1	39
8069-2	7314150238590	310	10	1	39
8070	7314150007110	310	10	5	39
8070 C	7314150007127	310	10	5	39
8070 C IP	7314150101641	310	10	5	39
8070 IP	7314150007134	310	10	40	39
8070-1	7314150239528	310	10	1	39
8070-2	7314150238606	310	10	1	39
8070V	7314150121519	310	25	2	442
8070VL	7314150213511	310	25	1	442
8071	7314150007202	310	10	5	39
8071 C	7314150007219	310	10	5	39
8071 C IP	7314150101658	310	10	5	39
8071 IP	7314150007226	310	10	50	39
8071-1	7314150239535	310	10	1	39
8071-2	7314150238613	310	10	1	39
8071V	7314150121526	310	25	2	442
8071VL	7314150213535	310	25	1	442
8071VLT	7314150121564	310	25	1	443
8072	7314150007288	310	10	5	39
8072 C	7314150007295	310	10	5	39
8072 C IP	7314150101665	310	10	5	39
8072 IP	7314150007301	310	10	30	39
8072-1	7314150239542	310	10	1	39
8072-2	7314150238620	310	10	1	39
8072V	7314150121533	310	25	2	442
8072VL	7314150213542	310	25	1	442
8072VLT	7314150121571	310	25	1	443
8073	7314150007363	310	10	5	39
8073 C	7314150007370	310	10	5	39
8073 C IP	7314150101672	310	10	5	39
8073 IP	7314150007387	310	10	20	39
8073-1	7314150239559	310	10	1	39
8073-2	7314150238637	310	10	1	39
8073V	7314150121540	310	25	2	442
8073VL	7314150213559	310	25	1	442
8073VLT	7314150121588	310	25	1	443
8074	7314150007448	310	10	3	39
8074 C	7314150007455	310	10	3	39
8074 C IP	7314150101689	310	10	3	39
8074 IP	7314150007462	310	10	20	39
8074-1	7314150239566	310	10	1	39
8074-2	7314150238644	310	10	1	39
8074V	7314150121557	310	25	2	442
8075	7314150007523	310	10	3	39
8075 C	7314150007530	310	10	3	39
8075 C IP	7314150101696	310	10	3	39
8075 IP	7314150007547	310	10	10	39
8075-1	7314150239573	310	10	1	39
8075-2	7314150238651	310	10	1	39
808050	7314153017642	350	38	50	188
808050A	7314150127306	350	46	1	195
808050L	7314150128075	350	38	25	188
808050L-SP1	7314150129218	350	38	1	188
808050P	7314150128105	350	38	50	188
808050P-25	7314150165179	350	38	10	188
808050S	7314150128082	350	38	25	189
808050S-18	7314150128921	350	38	30	189
808050S-22	7314150128938	350	38	30	189
808050TORX	7314150127313	350	46	50	195
808050TS	7314150128099	350	38	1	189
808060	7314150243822	350	38	1	439
808061	7314150243839	350	38	5	439
808062	7314150243846	350	38	5	439
8100B0100	7314150263011	338	10	1	245
8100B0140	7314150263028	338	10	1	245
8100B0180	7314150263042	338	10	1	245
8100B0240	8413345018296	338	10	1	245
8100B0360	8413345099660	338	10	1	245
8100B0480	7314150263110	338	10	1	245
8100F0100	8413345131735	338	10	1	245
8100F0140	7314150255030	338	10	1	245
8100F0180	7314150263059	338	10	1	245
8100F0240	7314150263066	338	10	1	245
8100F0360	8413345135849	338	10	1	245
8100F0480	7314150263134	338	10	1	245
8100T0100	7314150263073	338	10	1	245
8100T0140	8413345018333	338	10	1	245
8100T0180	7314150263080	338	10	1	245
8100T0240	7314150263097	338	10	1	245



CUENTA	SUBGRUPO				
8100T0360	7314150263103	338	10	1	245
8110-1/2	7314151808853	354	20	1	91
8110-SO/1	7314151809751	354	20	1	91
8110H-1/2	7314153015860	354	20	1	91
8120-1/2	7314150384884	312	25	12	90
8120-1/4	7314150384921	312	25	20	69
8120-3/8	7314150384914	312	25	10	79
813	7314150055852	340	10	1	581
8130	7314150050918	340	10	10	578
8131	7314150050925	340	10	10	578
8131 CO	7314150051519	340	10	10	578
8132	7314150050932	340	10	10	578
8140	7314150050949	340	10	10	578
8140 CO	7314150051533	340	10	10	578
8141	7314150050987	340	10	10	578
8141 CO	7314150051557	340	10	10	578
8142	7314150051007	340	10	10	578
8142 CO	7314150051564	340	10	10	578
8143	7314150051021	340	10	10	578
8144	7314150051045	340	10	10	578
8144 CO	7314150051601	340	10	10	578
8145	7314150051052	340	10	10	578
8146	7314150051076	340	10	10	578
8147	7314150051083	340	10	10	578
8148	7314150051090	340	10	10	578
8148 CO	7314150051656	340	10	10	578
8149	7314150051106	340	10	10	578
8150	7314150051113	340	10	10	578
8150 CO	7314150051670	340	10	10	578
8150 J	7314150051137	340	10	10	578
8150-1/2	7314151105006	354	20	1	90
8150-1/2-SPARE	7314150187881	354	20	1	91
8150-1/2V	7314150121601	354	40	1	444
8150RN-1/2	7314151831202	354	20	1	90
8150RN-1/2-SPARE	7314150209378	354	20	1	91
8150SL	7314150197682	354	20	1	90
8150SL-SPARE	7314150210275	354	20	1	91
8151	7314150051199	340	10	10	578
8151 CO	7314150051694	340	10	10	578
8151-1/2	7314151105112	354	20	1	91
8152	7314150052097	340	10	10	578
8152-1/2	7314151105129	354	15	1	87
8153	7314150051205	340	10	10	578
8154	7314150052103	340	10	10	578
8154 CO	7314150052233	340	10	10	578
8154-1/2	7314151105143	354	15	1	87
8154-1/2V	7314150121595	354	40	1	444
8155	7314150052110	340	10	10	578
8155-1/2	7314151827595	354	20	1	90
8155-SO/1	7314153000811	354	20	1	91
8156	7314150051212	340	10	10	578
8156-1/2	7314150166053	354	15	1	87
8157	7314150052127	340	10	10	578
8158	7314150052134	340	10	10	578
8158-1/2	7314151105167	354	15	1	87
8158-SO/1	7314150111039	354	15	1	91
8159-1/2	7314151105198	354	15	1	87
8159-W	7314150107186	354	15	1	87
8160	7314150051229	340	10	10	578
8160 CO	7314150051724	340	10	10	578
8160 J	7314150051250	340	10	10	578
8160-1/2	7314151105204	354	15	1	87
8160-1/2V	7314150121618	354	40	1	444
8160-B	7314150182565	354	15	1	87
8160-W	7314150107193	354	15	1	87
8161	7314150051328	340	10	10	578
8161 CO	7314150051748	340	10	10	578
8162	7314150051335	340	10	10	578
8162-1/2	7314151105211	354	15	1	87
8162-1/2V	7314150121625	354	40	1	444
8162-W	7314150107209	354	15	10	87
8163	7314150051342	340	10	10	578
8163 CO	7314150051762	340	10	10	578
8164	7314150052141	340	10	10	578
8164-1/2	7314151105266	354	15	1	78
8165	7314150052158	340	10	10	578
8165 CO	7314150052288	340	10	10	578
8165-1/2	7314151105273	354	15	1	88
8166-1/2	7314151105280	354	15	1	87
8167	7314153003584	354	15	1	79
8167-1/2	7314150181094	354	15	1	87
8168	7314150128440	354	15	1	88
8169-1/2	7314150313570	354	15	1	87
8170-1/2	7314150313587	354	15	1	87
8193-1/2	7314151831219	354	20	1	90
8194-1/2	7314151831226	354	20	1	91
8195-KEY	7314150389810	354	20	50	88
8195-R	7314150389780	354	20	1	90
8195-SET	7314150389797	354	20	1	90
8195-SQ	7314150389803	354	20	25	91
8211	7314150101030	340	10	10	579
8220SL-2P	7314150243860	350	38	1	439
8223	7314150112685				

8225 IP



CUENTA SUBGRUPO



8225 IP	7314150101764	340	75	4	225
8225CIP	7314150103614	340	75	4	225
8226	7314150115853	340	75	1	225
8231	7311518266509	340	75	5	225
8231 IP	7311518270285	340	75	5	225
8242-2P	7314150243686	350	10	1	189
8242L-2P	7314150246687	350	10	1	189
8247	7314150051397	340	10	10	579
8247 CO	7314150051809	340	10	10	579
8248	7314150051427	340	10	10	579
8248 CO	7314150051823	340	10	10	579
8252-2P	7314150243693	350	10	1	189
8252L-2P	7314150246694	350	10	1	189
8252XL-1P	7314150265985	350	10	1	190
833AJ-4	7311518286927	318	15	1	528
833AJ-5	7311518286934	318	15	1	528
833AJ-6	7311518286941	318	15	1	528
833FJ-4	7311518286965	318	15	1	528
833FJ-5	7311518286972	318	15	1	528
833FJ-6	7311518286989	318	15	1	528
833PJ-4	7311518286897	318	15	1	527
833PJ-5	7311518286903	318	15	1	527
833PJ-67	7311518286910	318	15	1	527
833SB-4	7311518286859	318	15	1	528
833SB-5	7311518286866	318	15	1	528
833SB-6	7311518286873	318	15	1	528
833SB-7	7311518286880	318	15	1	528
834V-2	7314150124992	318	15	1	527
834V-4	7311518286811	318	15	1	527
834V-5	7311518286828	318	15	1	527
834V-6	7311518286835	318	15	1	527
834V-7	7311518286842	318	15	1	527
84-PODGER	7314150307494	310	10	1	39
850-1	7311518292737	362	10	10	490
8501-10	7311518004828	346	10	1	142
8501-10F	7311518220945	346	10	1	142
8501-12	7311518004842	346	10	1	142
8501-12F	7311518220952	346	10	1	142
8501-13	7311518004859	346	10	1	142
8501-136-10-24C	7314150371471	346	10	1	143
8501-136-20-24C	7314150371488	346	10	1	143
8501-13F	7311518220969	346	10	1	142
8501-15	7311518004873	346	10	1	142
8501-150-10-24C	7314150403004	346	10	1	143
8501-15F	7311518220976	346	10	1	142
8501-16	7311518004880	346	10	1	142
8501-160-20-24C	7314150403011	346	10	1	143
8501-160-20-48XF	7314150402892	346	10	1	143
8501-165-20-24C	7314150403028	346	10	1	143
8501-165-20-48XF	7314150402908	346	10	1	143
8501-16F	7311518220983	346	10	1	142
8501-16SW	7314150258642	346	10	1	143
8501-17	7311518004897	346	10	1	142
8501-17F	7311518220990	346	10	1	142
8501-17S	7311518221027	346	10	1	142
8501-184-16-24	7314150402946	346	10	1	142
8501-184-16-40	7314150402953	346	10	1	142
8501-184-20-24C	7314150403042	346	10	1	143
8501-18S	7311518221034	346	10	1	142
8501-18SW	7311518221058	346	10	1	143
8501-190-30-24C	7314150403059	346	10	1	143
8501-190-30-60XF	7314150402960	346	10	1	142
8501-2	7311518004743	346	10	1	142
8501-210-30-48SW	7314150403066	346	10	1	143
8501-210-30-60XF	7314150402977	346	10	1	142
8501-216-60SW	7314150359448	346	10	1	143
8501-22	7311518178888	346	10	1	142
8501-22F	7311518221003	346	10	1	142
8501-23	7311518004958	346	10	1	142
8501-230-30-60XF	7314150402984	346	10	1	142
8501-235-30-60XF	7314150402991	346	10	1	142
8501-23F	7311518018887	346	10	1	142
8501-260-24SW	7314150359479	346	10	1	143
8501-260-30-80S	7314150403097	346	10	1	142
8501-260-40SW	7314150359462	346	10	1	143
8501-260-60SW	7314150359455	346	10	1	143
8501-28	7311518018894	346	10	1	142
8501-28F	7311518221010	346	10	1	142
8501-28S	7311518221041	346	10	1	142
8501-28SW	7311518221065	346	10	1	143
8501-28XF	7311518281946	346	10	1	142
8501-3	7311518004750	346	10	1	142
8501-30	7311518237479	346	10	1	142
8501-305-30-40SW	7314150403073	346	10	1	143
8501-305-30-60SW	7314150403080	346	10	1	143
8501-305-30-96S	7314150403103	346	10	1	142
8501-30F	7311518237462	346	10	1	142
8501-30S	7311518282240	346	10	1	142
8501-30SW	7311518282196	346	10	1	143
8501-30XF	7311518281984	346	10	1	142
8501-31	7311518237455	346	10	1	142
8501-31F	7311518237448	346	10	1	143
8501-4	7311518008079	346	10	1	142
8501-40	7311518282042	346	10	1	143
8501-4F	7311518220914	346	10	1	142
8501-4XF	7311518281786	346	10	1	142
8501-5	7311518004774	346	10	1	142
8501-5F	7311518220921	346	10	1	142



CUENTA SUBGRUPO



8501-7	7311518004798	346	10	1	142
8501-7F	7311518220938	346	10	1	142
8510SL-2P	7314150245758	350	38	1	440
8520SL-2P	7314150245765	350	38	1	440
86	7314150005376	310	10	1	39
86-1	7314150254996	310	10	1	39
86-2	7314150255009	310	10	1	39
8600-2P	7314150246564	350	10	1	189
8610-2P	7314150243648	350	10	1	189
8610L-2P	7314150246700	350	10	1	190
8610SL-2P	7314150243891	350	38	1	439
8620-2P	7314150243662	350	10	1	189
8620L-2P	7314150246717	350	10	1	190
8620SL-2P	7314150243907	350	38	1	439
8620XL-1P	7314150265947	350	10	1	189
8630-2P	7314150246571	350	10	1	189
8630XL-1P	7314150265961	350	10	1	189
864000010	8413345137638	362	15	1	492
864000020	7314150330171	362	15	1	492
864002450	8413345129022	362	15	50	492
864100010	8413345137621	362	15	1	493
864102400	8413345129015	362	15	50	492
865-1	7311518292744	362	10	10	490
869102500	8413345083669	340	70	6	517
869103000	8413345116640	340	70	6	517
869203000	8413345137508	340	70	6	517
8697M0260	8413345129763	340	70	1	516
8698M0250	8413345129787	340	70	1	516
87	7314150005406	310	10	3	39
87-1	7314150255016	310	10	1	39
87-2	7314150255023	310	10	1	39
8703-2P	7314150246632	350	10	1	190
8704-2P	7314150246649	350	10	1	190
8705-2P	7314150246656	350	10	1	191
8706-2P	7314150246663	350	10	1	191
8710SL-2P	7314150245772	350	38	1	440
8720SL-2P	7314150245789	350	38	1	440
874002000	8413345024938	358	15	5	542
874002500	8413345024945	358	15	5	542
874003000	8413345024952	358	15	5	542
874003500	8413345024969	358	15	5	542
874004000	8413345024976	358	15	5	542
874005000	8413345024983	358	15	5	542
874104000	8413345081061	358	15	5	543
874602000	8413345024990	358	15	5	543
874602500	8413345025003	358	15	5	543
874603000	8413345025065	358	15	5	543
874603500	8413345025072	358	15	5	543
874604000	8413345025089	358	15	5	543
876002000	8413345025119	358	15	10	543
876002500	8413345025126	358	15	5	543
877002400	8413345025140	358	15	8	543
8800-2P	7314150246588	350	10	1	190
8810-2P	7314150243655	350	10	1	190
8810L-2P	7314150246724	350	10	1	190
8810SL-2P	7314150243914	350	38	1	439
8820-2P	7314150243679	350	10	1	190
8820L-2P	7314150246731	350	10	1	190
8820SL-2P	7314150243921	350	38	1	439
8820XL-1P	7314150265954	350	10	1	190
8821MB	7314150220571	354	25	1	100
8830-2P	7314150246595	350	10	1	190
8830XL-1P	7314150265978	350	10	1	190
8840M	7314151105495	354	25	1	100
8845DM	7314151105525	354	25	1	100
8845NM	7314151810955	354	25	1	99
8900DM-19	7314151105730	354	10	1	97
8900DM-21	7314150166367	354	10	5	97
8900DM-22	7314151105754	354	10	1	97
8900DM-23	7314150166374	354	10	1	97
8900DM-24	7314151105778	354	10	1	97
8900DM-25	7314151105785	354	10	1	97
8900DM-26	7314150219797	354	10	1	97
8900DM-27	7314151105822	354	10	1	97
8900DM-28	7314151105846	354	10	1	97
8900DM-29	7314150219803	354	10	1	97
8900DM-30	7314151105884	354	10	1	97
8900DM-32	7314151105891	354	10	1	97
8900DM-33	7314150166398	354	10	1	97
8900DM-34	7314151838478	354	10	1	97
8900DM-35	7314150219810	354	10	1	97
8900DM-36	7314151105914	354	10	1	97
8900DM-37	7314150166404	354	10	1	97
8900DM-38	7314150219827	354	10	1	97
8900DM-40	7314150166411	354	10	1	97
8900DM-41	7314151105938				



CUENTA SUBGRUPO



8900DZ-1.1/4	7314151106096	354	10	1	97
8900DZ-1.1/8	7314151106072	354	10	1	97
8900DZ-1.11/16	7314150166282	354	10	1	97
8900DZ-1.13/16	7314151106188	354	10	1	97
8900DZ-1.3/16	7314151106089	354	10	1	97
8900DZ-1.3/4	7314151106171	354	10	1	97
8900DZ-1.3/8	7314151106119	354	10	1	97
8900DZ-1.5/16	7314151106102	354	10	1	97
8900DZ-1.5/8	7314151106157	354	10	1	97
8900DZ-1.7/16	7314151106126	354	10	1	97
8900DZ-1.7/8	7314151106195	354	10	1	97
8900DZ-1.9/16	7314150166299	354	10	1	97
8900DZ-13/16	7314150166305	354	10	1	97
8900DZ-15/16	7314151106034	354	10	1	97
8900DZ-2	7314151106201	354	10	1	97
8900DZ-2.1/16	7314150166312	354	10	1	97
8900DZ-2.1/4	7314150166329	354	10	1	97
8900DZ-2.1/8	7314150166336	354	10	1	97
8900DZ-2.3/16	7314150358670	354	10	1	97
8900DZ-2.3/8	7314150166350	354	10	1	97
8900DZ-3/4	7314150166381	354	10	1	97
8900DZ-31/32	7314150358663	354	10	1	97
8900DZ-7/8	7314150166473	354	10	1	97
8900SM-19	7314150166633	354	10	1	97
8900SM-22	7314151810795	354	10	1	97
8900SM-23	7314150219834	354	10	1	97
8900SM-24	7314151810801	354	10	1	97
8900SM-26	7314150219841	354	10	1	97
8900SM-27	7314151810818	354	10	1	97
8900SM-28	7314150166657	354	10	1	97
8900SM-29	7314150219858	354	10	1	97
8900SM-30	7314151810825	354	10	1	97
8900SM-32	7314151810832	354	10	1	97
8900SM-33	7314150166671	354	10	1	97
8900SM-34	7314151838461	354	10	1	97
8900SM-35	7314150166688	354	10	1	97
8900SM-36	7314151810849	354	10	1	97
8900SM-38	7314151810856	354	10	1	97
8900SM-41	7314151810863	354	10	1	97
8900SM-42	7314150219865	354	10	1	97
8900SM-46	7314151810870	354	10	1	97
8900SM-50	7314151810887	354	10	1	97
8900SM-55	7314151810894	354	10	1	97
8900SM-60	7314151810900	354	10	1	97
8900SZ-1	7314150166480	354	10	1	97
8900SZ-1.1/16	7314150166497	354	10	1	97
8900SZ-1.1/2	7314150166503	354	10	1	97
8900SZ-1.1/4	7314150166510	354	10	1	97
8900SZ-1.1/8	7314150166527	354	10	1	97
8900SZ-1.13/16	7314150166534	354	10	1	97
8900SZ-1.3/4	7314150166541	354	10	1	97
8900SZ-1.3/8	7314150166558	354	10	1	97
8900SZ-1.5/16	7314150166565	354	10	1	97
8900SZ-1.5/8	7314150166572	354	10	1	97
8900SZ-1.7/16	7314150166589	354	10	1	97
8900SZ-1.7/8	7314150166596	354	10	1	97
8900SZ-1.9/16	7314150166602	354	10	1	97
8900SZ-13/16	7314150166619	354	10	1	97
8900SZ-15/16	7314150166626	354	10	1	97
8900SZ-3/4	7314150166664	354	10	1	97
8900SZ-7/8	7314150166695	354	10	1	97
89049TM-1000	7314150415403	360	30	1	129
8905-TM	7314150125470	360	30	1	129
8910-2P	7314150243709	350	10	1	190
8910SL-2P	7314150243938	350	38	1	440
8915-2P	7314150243716	350	10	1	190
8915L-2P	7314150258765	350	10	1	190
8915SL-2P	7314150243945	350	38	1	440
8920-2P	7314150243723	350	10	1	190
8920L-2P	7314150258772	350	10	1	190
8920SL-2P	7314150243952	350	38	1	440
89222CR-1000	7314150415441	360	30	1	130
8925-2P	7314150243730	350	10	1	190
8925L-2P	7314150258789	350	10	1	190
8925SL-2P	7314150243969	350	38	1	440
8927-2P	7314150243747	350	10	1	190
8927L-2P	7314150263516	350	10	1	190
8930-2P	7314150243754	350	10	1	190
8930L-2P	7314150258796	350	10	1	190
8930SL-2P	7314150243976	350	38	1	440
8940-2P	7314150243761	350	10	1	190
894M-10	7314151833039	366	10	10	52
894M-100	7314151833305	366	10	1	52
894M-105	7314151833312	366	10	1	52
894M-11	7314151833046	366	10	10	52
894M-110	7314151833329	366	10	1	52
894M-115	7314151833336	366	10	1	52
894M-12	7314151833053	366	10	10	52
894M-120	7314151833343	366	10	1	52
894M-125	7314150132478	366	10	1	52
894M-13	7314151833060	366	10	10	52
894M-130	7314150132485	366	10	1	52
894M-135	7314150132492	366	10	1	52
894M-14	7314151833077	366	10	10	52
894M-15	7314151833084	366	10	10	52
894M-16	7314150139569	366	10	10	52
894M-17	7314151833091	366	10	10	52
894M-19	7314151833107	366	10	10	52



CUENTA SUBGRUPO



894M-21	7314150223220	366	10	5	52
894M-22	7314151833114	366	10	5	52
894M-24	7314151833121	366	10	5	52
894M-27	7314151833138	366	10	5	52
894M-30	7314151833145	366	10	5	52
894M-32	7314151833152	366	10	5	52
894M-34	7314150139583	366	10	1	52
894M-36	7314151833169	366	10	5	52
894M-38	7314151833176	366	10	1	52
894M-41	7314151833183	366	10	1	52
894M-46	7314151833190	366	10	1	52
894M-50	7314151833206	366	10	1	52
894M-55	7314151833213	366	10	1	52
894M-60	7314151833220	366	10	1	52
894M-65	7314151833237	366	10	1	52
894M-7	7314151833008	366	10	10	52
894M-70	7314151833244	366	10	1	52
894M-75	7314151833251	366	10	1	52
894M-8	7314151833015	366	10	10	52
894M-80	7314151833268	366	10	1	52
894M-85	7314151833275	366	10	1	52
894M-9	7314151833022	366	10	10	52
894M-90	7314151833282	366	10	1	52
894M-95	7314151833299	366	10	1	52
8950N	7314151810931	354	20	1	98
8950N/A	7314151810948	354	20	1	99
8950NA-SO/2	7314151816605	354	20	1	99
8951	7314151106782	354	20	1	99
8951-M	7314150124916	360	10	1	120
8952N	7314150180196	354	20	1	99
8952N/A	7314150180202	354	20	1	99
8952N/B	7314150180219	354	15	1	98
8953	7314151106799	354	15	1	98
8954	7314151106805	354	15	1	98
8954A	7314151106812	354	15	1	98
8955N	7314150434114	354	20	1	99
8955N-SPARE	7314150434121	354	20	1	99
8955N/A	7314150434053	354	20	1	99
8955N/B	7314150434176	354	15	1	99
8958	7314151106829	354	15	1	98
8958A	7314151106836	354	15	1	98
895M-10-11	7314151832742	366	10	10	50
895M-10-13	7314151832759	366	10	10	50
895M-13-17	7314151832803	366	10	10	50
895M-17-19	7314151832827	366	10	10	50
895M-19-22	7314151832834	366	10	10	50
895M-19-24	7314151832841	366	10	5	50
895M-22-24	7314151832858	366	10	5	50
895M-24-27	7314151832865	366	10	5	50
895M-24-30	7314151832872	366	10	5	50
895M-27-32	7314151832889	366	10	5	50
895M-30-32	7314151832896	366	10	5	50
895M-30-36	7314151832902	366	10	1	50
895M-32-36	7314151832919	366	10	1	50
895M-36-41	7314151832926	366	10	1	50
895M-41-46	7314151832933	366	10	1	50
895M-46-50	7314151832940	366	10	1	50
895M-50-55	7314151832957	366	10	1	50
895M-55-60	7314151832964	366	10	1	50
895M-6-7	7314151832711	366	10	10	50
895M-65-70	7314151832971	366	10	1	50
895M-8-10	7314151832735	366	10	10	50
895M-8-9	7314151832728	366	10	10	50
8961	7314151106850	354	15	1	98
8962	7314151106867	354	15	1	98
8963	7314150181087	354	15	1	98
8964	7314151106874	354	15	1	88
8965	7314151106881	354	15	1	98
8966	7314151106898	354	15	1	98
8967	7314153003591	354	15	1	88
8967/S3	7314153003607	354	25	1	67
9-12-51/3806-KP	7311518044558	316	10	5	568
9-462-14-0-0	7311518020873	324	20	5	34
9-463-14-0-0	7311518327750	324	55	1	34
9-467-00-0-0	7311518020897	324	55	1	34
9-469-00-0-0	7311518020903	324	55	1	34
9-484-3.2-10	7311518193348	324	50	10	34
9-484-3.2-1P	7311518193522	324	50	10	34
9-484-5.2-10	7311518193355	324	50	10	34
9-484-5.2-1P	7311518193331	324	50	10	34
9-485-04-10	7314150271672	324	50	10	34
9-485-04-1P	7314150271665	324	50	10	35
9-485-05-10	7314150271696	324	50	10	34
9-485-05-1P	7314150271689	324	50	10	35
9-485-06-10	7311518193508	324	50	10	34
9-485-06-1P	7311518193492	324			



CUENTA SUBGRUPO



9-486-C-1P	7311518209605	324	50	10	35
9-488-02-10	7311518194772	324	50	10	34
900T-020-100	7314153018106	350	42	5	194
900T-025-100	7314153018113	350	42	5	194
900T-030-100	7314153018120	350	42	5	194
900T-040-150	7314153018137	350	42	5	194
900T-050-150	7314153018144	350	42	5	194
900T-060-200	7314153018151	350	42	5	194
900T-080-200	7314153018168	350	42	5	194
900T-100-200	7314153018175	350	42	5	194
901T-006-100	7314153018182	350	42	5	194
901T-007-100	7314153018199	350	42	5	194
901T-008-100	7314153018205	350	42	5	194
901T-009-100	7314153018212	350	42	5	194
901T-010-100	7314153018229	350	42	5	194
901T-015-150	7314153018236	350	42	5	194
901T-020-150	7314153018243	350	42	5	194
901T-025-150	7314153018250	350	42	5	194
901T-027-150	7314153018267	350	42	5	194
901T-030-200	7314153018274	350	42	5	194
901T-040-200	7314153018281	350	42	5	194
901T-045-200	7314153018298	350	42	5	194
901T-050-200	7314153018304	350	42	5	194
9029	7314153010612	310	10	5	38
9029 C	7314153010629	310	10	5	38
9029-1	7314150239580	310	10	1	39
9029-2	7314150238668	310	10	1	39
9029-T	7314150189076	310	10	5	38
9029T-1	7314150312139	310	10	1	39
902T-050-150	7314153018311	350	42	5	194
902T-055-150	7314153018328	350	42	5	194
902T-060-150	7314153018335	350	42	5	194
902T-070-175	7314153018342	350	42	5	194
902T-080-175	7314153018359	350	42	5	194
902T-090-175	7314153018366	350	42	5	194
902T-100-175	7314153018373	350	42	5	194
902T-110-175	7314153018380	350	42	5	194
902T-120-175	7314153018397	350	42	5	194
902T-130-175	7314153018404	350	42	5	194
9031	7314150110988	310	10	5	38
9031 C	7314150113507	310	10	5	38
9031 P-1	7314150266302	310	10	1	39
9031-1	7314150239597	310	10	1	39
9031-8224	7314150321193	310	10	3	236
9031-T	7314150131648	310	10	5	38
9031P	7314150187539	310	10	5	38
9031T-1	7314150312146	310	10	1	39
9033	7314150181414	310	10	5	38
9033-1	7314150353804	310	10	1	39
9035	7314150181421	310	10	5	38
9035-1	7314150353811	310	10	1	39
903T-1	7314153018410	350	42	1	194
903T-2	7314153018427	350	42	1	194
903T-3	7314153018434	350	42	1	195
9045-B-200	7311518012175	336	10	6	487
9045-B-250	7311518012182	336	10	6	487
9045-B-300	7311518012199	336	10	6	487
9045-B-400	7311518178123	336	10	1	487
9048-200	7314150138159	336	10	10	488
9048-250	7314150138166	336	10	10	488
9048-300	7314150138173	336	10	10	488
9048-350	7314150180349	336	10	10	488
9048-400	7314150138180	336	10	10	488
904T-060-150	7314153019837	350	42	5	195
905T-060-100	7314153019844	350	10	5	194
9070	7314150100170	310	10	5	38
9070 P	7314150103416	310	10	5	38
9070 P-1	7314150239610	310	10	1	39
9070 PC	7314150103423	310	10	5	38
9070C	7314150100187	310	10	5	38
9071	7314150100194	310	10	5	38
9071 P	7314150103430	310	10	5	38
9071 P-1	7314150239627	310	10	1	39
9071 PC	7314150103447	310	10	5	38
9071C	7314150100200	310	10	5	38
9072	7314150055609	310	10	5	38
9072 C	7314150055616	310	10	5	38
9072 P	7314150056354	310	10	5	38
9072 P-1	7314150239634	310	10	1	39
9072 PC	7314150056361	310	10	5	38
9073	7314150101702	310	10	5	38
9073 C	7314150101719	310	10	3	38
9073 P	7314150101726	310	10	5	38
9073 P-1	7314150239641	310	10	1	39
9073 PC	7314150101733	310	10	3	38
91-023-5P	7311518032593	346	40	1	142
91-027-5P	7311518032616	346	40	1	142
91-143-5P	7311518032630	346	40	1	142
91-148-5P	7311518032654	346	40	1	142
91-223-5P	7311518032661	346	40	1	142
91-226-5P	7311518032685	346	40	1	142
91-233-5P	7311518260057	346	40	1	142
91-243-5P	7311518032692	346	40	1	142
91-2PW-5P	7311518260163	346	40	1	142
91-3PM-5P	7311518260156	346	40	1	142
91-412-5P	7311518260040	346	40	1	142
91-433-5P	7311518260101	346	40	1	142
91-434-5P	7311518260026	346	40	1	142



CUENTA SUBGRUPO



91-443-5P	7311518032722	346	40	1	142
91-444-5P	7311518260033	346	40	1	142
91-4PWM-5P	7311518260170	346	40	1	142
91-502-5P	7311518032746	346	40	1	142
91-512-5P	7311518032753	346	40	1	142
91-517-5P	7311518032777	346	40	1	142
91-522-5P	7311518032784	346	40	1	142
91-611-5P	7311518260071	346	40	1	142
91-612-5P	7311518032814	346	40	1	142
91-622-5P	7311518260088	346	40	1	142
91-623-5P	7311518260064	346	40	1	142
91-7V1-5P	7311518260118	346	40	1	142
91C	7314150182381	310	15	5	40
9210	7311518278182	344	15	1	574
9210-1	7311518278212	344	15	1	574
9210-10	7311518278229	344	15	1	574
9210-1060177	7311518295424	344	15	1	575
9210-1060238	7311518295394	344	15	20	575
9210-1230219	7311518295387	344	15	20	575
9210-1230235	7311518295325	344	15	1	574
9210-1320281	7311518295431	344	15	10	575
9210-1640142	7311518295356	344	15	1	574
9210-1690148	7311518295332	344	15	1	574
9210-1700118	7311518295363	344	15	1	574
9210-1710266	7311518295417	344	15	1	575
9210-1720100	7311518295295	344	15	1	574
9210-1730107	7311518295349	344	15	10	574
9210-1770106	7311518295370	344	15	10	574
9210-1830137	7311518295400	344	15	1	575
9210-20	7311518278236	344	15	1	574
92C	7314150182398	310	15	5	40
93C	7314150182404	310	15	5	40
94C	7314150182411	310	15	5	40
9500DZ-1.13/16	7314150227501	354	10	1	101
9500DZ-1.5/8	7314150227495	354	10	1	101
9500DZ-1.7/8	7314150227518	354	10	1	101
9500DZ-2	7314150227525	354	10	1	101
9500DZ-2.1/2	7314150227570	354	10	1	101
9500DZ-2.1/4	7314150227556	354	10	1	101
9500DZ-2.1/8	7314150227532	354	10	1	101
9500DZ-2.15/16	7314150227617	354	10	1	101
9500DZ-2.3/16	7314150227549	354	10	1	101
9500DZ-2.3/4	7314150227600	354	10	1	101
9500DZ-2.3/8	7314150227563	354	10	1	101
9500DZ-2.5/8	7314150227594	354	10	1	101
9500DZ-2.9/16	7314150227587	354	10	1	101
9500DZ-3	7314150227624	354	10	1	101
9500DZ-3.1/8	7314150227631	354	10	1	101
9500SM-41	7314153013699	354	10	1	100
9500SM-46	7314153013705	354	10	1	100
9500SM-50	7314153013712	354	10	1	100
9500SM-54	7314153013729	354	10	1	100
9500SM-55	7314153013736	354	10	1	100
9500SM-58	7314153013743	354	10	1	100
9500SM-60	7314153013750	354	10	1	100
9500SM-63	7314153013767	354	10	1	100
9500SM-65	7314153013774	354	10	1	100
9500SM-67	7314153013781	354	10	1	100
9500SM-70	7314153013798	354	10	1	100
9500SM-71	7314153013804	354	10	1	100
9500SM-75	7314153013811	354	10	1	100
9500SM-77	7314153013828	354	10	1	100
9500SM-80	7314153013835	354	10	1	100
9500SM-82	7314153013842	354	10	1	100
9505-3400	7314150125517	360	30	1	130
9505-TM	7314150125487	360	30	1	129
95155B-3000	7314150415410	360	30	1	130
9525-10	7311518031817	346	30	1	154
9525-3400	7314150125524	360	30	1	130
9525-7	7311518031800	346	30	1	154
9525CR-4000	7314150415465	360	30	1	130
9526B-4500	7314150415427	360	30	1	130
9527CR-2000	7314150415458	360	30	1	130
9528-MD-15-45	7311518007447	346	30	10	153
9528-MD-22-76	7311518041441	346	30	10	153
9540DZ	7314150414048	354	25	1	102
9540DZL	7314150414055	354	25	1	102
9540MB	7314153014108	354	25	1	102
9540MBL	7314153014115	354	25	1	102
9550N	7314150424160	354	20	1	101
9550N-SPARE	7314150424153	354	20	1	101
9550N/A	7314150424146	354	20	1	101
9550N/B	7314150424788	354	15	1	101
9555	731415				

9574-250	7314150138203	336	10	10	487				
9574-300	7314150180356	336	10	10	487				
9575-250	7314150185894	336	10	6	487				
95C	7314150182428	310	15	1	40				
960100010	8413345031073	356	15	1	396				
960100020	8413345031080	356	15	1	396				
960100030	8413345031097	356	15	1	396				
960100050	8413345031103	356	15	1	396				
960100060	8413345031110	356	15	1	396				
9625-9500	7314150125555	360	30	1	130				
96255CR-7000	7314150415489	360	30	1	130				
9626-10	7314150388844	346	30	1	153				
9626-11	7314150388851	346	30	1	153				
9626-12	7314150388868	346	30	1	153				
9626-13	7314150388875	346	30	1	153				
9626-14	7314150388882	346	30	1	153				
9626-16	7314150388899	346	30	1	153				
9626-18	7314150388905	346	30	1	153				
9626-20	7314150388912	346	30	1	153				
9626-22	7314150388929	346	30	1	153				
9626-23	7314150388936	346	30	1	153				
9626-24	7314150388943	346	30	1	153				
9626-25	7314150388950	346	30	1	153				
9626-26	7314150324237	346	30	1	153				
9626-28	7314150388967	346	30	1	153				
9626-30	7314150388974	346	30	1	153				
9626-32	7314150388981	346	30	1	153				
9626-6	7314150388806	346	30	1	153				
9626-8	7314150388820	346	30	1	153				
9626-9	7314150388837	346	30	1	153				
9627-10-460	7314150389018	346	30	1	153				
9627-12-460	7314150389025	346	30	1	153				
9627-14-460	7314150389032	346	30	1	153				
9627-16-460	7314150389049	346	30	1	153				
9627-18-460	7314150389056	346	30	1	153				
9627-20-460	7314150389063	346	30	1	153				
9627-22-460	7314150389070	346	30	1	153				
9627-24-460	7314150389087	346	30	1	153				
9627-26-460	7314150389094	346	30	1	153				
9627-28-460	7314150389100	346	30	1	153				
9627-30-460	7314150389117	346	30	1	153				
9627-32-460	7314150389124	346	30	1	153				
9627-6-460	7314150388998	346	30	1	153				
9627-8-460	7314150389001	346	30	1	153				
9629-10	7314150388479	346	30	1	153				
9629-12	7314150388486	346	30	1	153				
9629-14	7314150388493	346	30	1	153				
9629-16	7314150388509	346	30	1	154				
9629-18	7314150388516	346	30	1	154				
9629-20	7314150388523	346	30	1	154				
9629-22	7314150388530	346	30	1	154				
9629-24	7314150388547	346	30	1	154				
9629-25	7314150388554	346	30	1	154				
9629-26	7314150388561	346	30	1	154				
9629-28	7314150388578	346	30	1	154				
9629-30	7314150388585	346	30	1	154				
9629-32	7314150388592	346	30	1	154				
9629-36	7314150388608	346	30	1	154				
9629-38	7314150388615	346	30	1	154				
9629-40	7314150388622	346	30	1	154				
9629-6	7314150388417	346	30	1	153				
9629-8	7314150388462	346	30	1	153				
9631-10-400	7314150388684	346	27	1	154				
9631-12-400	7314150388691	346	30	1	154				
9631-14-400	7314150388707	346	30	1	154				
9631-16-400	7314150388714	346	30	1	154				
9631-18-400	7314150388721	346	30	1	154				
9631-20-400	7314150388738	346	30	1	154				
9631-22-400	7314150388745	346	30	1	154				
9631-24-400	7314150388752	346	30	1	154				
9631-28-400	7314150388776	346	30	1	154				
9631-30-400	7314150388783	346	30	1	154				
9631-32-400	7314150388790	346	30	1	154				
9631-6-400	7314150388646	346	30	1	154				
9631-8-400	7314150388677	346	30	1	154				
9646-10	7314150388264	346	30	1	154				
9646-10-250	7314150388387	346	30	1	154				
9646-11	7314150388288	346	30	1	154				
9646-12	7314150388295	346	30	1	154				
9646-12-250	7314150388400	346	30	1	154				
9646-13	7314150388301	346	30	1	154				
9646-14	7314150388318	346	30	1	154				
9646-15	7314150388325	346	30	1	154				
9646-16	7314150388332	346	30	1	154				
9646-18	7314150388349	346	30	1	154				
9646-20	7314150388356	346	30	1	154				
9646-3	7314150388189	346	30	1	154				
9646-4	7314150388202	346	30	1	154				
9646-5	7314150388219	346	30	1	154				
9646-6	7314150388226	346	30	1	154				
9646-6-250	7314150388363	346	30	1	154				
9646-7	7314150388233	346	30	1	154				
9646-8	7314150388240	346	30	1	154				
9646-8-250	7314150388370	346	30	1	154				
9646-9	7314150388257	346	30	1	154				
96C	7314150134120	310	15	1	40				
97-1	7314150366637	360	15	1	126				
97-1/2	7314150366545	360	15	1	126				

97-1/4	7314150366507	360	15	1	126				
97-10	7314150366286	360	15	1	125				
97-11	7314150366293	360	15	1	125				
97-11/16	7314150366583	360	15	1	126				
97-12	7314150366309	360	15	1	125				
97-13	7314150366316	360	15	1	125				
97-13/16	7314150366606	360	15	1	126				
97-14	7314150366323	360	15	1	125				
97-15	7314150366330	360	15	1	125				
97-15/16	7314150366620	360	15	1	126				
97-16	7314150366347	360	15	1	125				
97-17	7314150366354	360	15	1	125				
97-17/32	7314150366552	360	15	1	126				
97-18	7314150366361	360	15	1	125				
97-19	7314150366378	360	15	1	125				
97-21	7314150366385	360	15	1	125				
97-22	7314150349722	360	15	1	125				
97-24	7314150357048	360	15	1	125				
97-27	7314150366392	360	15	1	125				
97-3/4	7314150366590	360	15	1	126				
97-3/8	7314150366521	360	15	1	126				
97-30	7314150366408	360	15	1	125				
97-32	7314150366415	360	15	1	125				
97-5/16	7314150366514	360	15	1	126				
97-5/8	7314150366576	360	15	1	126				
97-7	7314150366255	360	15	1	125				
97-7/16	7314150366538	360	15	1	126				
97-7/8	7314150366613	360	15	1	126				
97-8	7314150366262	360	15	1	125				
97-9	7314150366279	360	15	1	125				
97-9/16	7314150366569	360	15	1	126				
9710-10-175	7314151785789	350	44	5	195				
9710-3.5-75	7314151785192	350	44	10	195				
9710-5.5-100	7314151785352	350	44	10	195				
9710-6.5-125	7314151785437	350	44	10	195				
9710-8-150	7314151785512	350	44	5	195				
9710/S6	7314151802301	350	44	1	196				
9715-14-250	7314153010148	350	18	5	187				
9733	7314150103256	340	10	1	235				
9778-1	7314151793524	350	44	10	196				
9778-2	7314151793531	350	44	10	196				
9778-3	7314151793548	350	44	5	196				
9778PZD-1	7314151823535	350	44	10	196				
9778PZD-2	7314151823542	350	44	10	196				
97C	7314150128211	310	15	1	40				
98-1/2	7314150367481	360	15	1	127				
98-1/4	7314150367443	360	15	1	127				
98-10	7314150367320	360	15	1	126				
98-11	7314150367337	360	15	1	126				
98-11/16	7314150367511	360	15	1	127				
98-12	7314150367344	360	15	1	126				
98-13	7314150367351	360	15	1	126				
98-13/16	7314150367535	360	15						



CUENTA SUBGRUPO



99-16	7314150368068	360	15	1	127
99-17	7314150368075	360	15	1	127
99-18	7314150368082	360	15	1	127
99-19	7314150368099	360	15	1	127
99-21	7314150368105	360	15	1	127
99-22	7314150368112	360	15	1	127
99-24	7314150368129	360	15	1	127
99-3/4	7314150368198	360	15	1	127
99-3/8	7314150368136	360	15	1	127
99-5/8	7314150368174	360	15	1	127
99-7/16	7314150368143	360	15	1	127
99-9/16	7314150368167	360	15	1	127
9938	7314150056491	340	30	1	229
9A-14	7314150368204	360	15	1	124
9B-1/4	7314150366071	360	15	1	125
9B-5/16	7314150366088	360	15	1	125
9F-1/2	7314150366194	360	15	1	125
9F-1/4	7314150366170	360	15	1	125
9F-3/8	7314150366187	360	15	1	125
9P-1/2	7314150366057	360	15	1	124
9P-1/4	7314150366033	360	15	1	124
9P-3/8	7314150366040	360	15	1	124
9Q-1/2	7314150366019	360	15	1	125
9Q-1/4	7314150365999	360	15	1	125
9Q-3/8	7314150366002	360	15	1	125
9R-1/2	7314150365913	360	15	1	124
9R-1/4	7314150365890	360	15	1	124
9R-3/8	7314150365906	360	15	1	124
9T-1/2	7314150366118	360	15	1	124
9T-1/4	7314150366095	360	15	1	124
9T-3/8	7314150366101	360	15	1	124
9W	7314150354399	360	15	1	124
A0313C03	7311518023713	346	15	1	144
A0313F03	7311518023690	346	15	1	144
A0313F03E	7311518212780	346	15	1	144
A0313M03	7311518023706	346	15	1	144
A0313M03E	7311518192150	346	15	1	144
A0313M03X	7311518182038	346	15	1	144
A0313M03XE	7311518181475	346	15	1	144
A0313M03XE-60	7311518184513	346	15	1	144
A0313M03XE-80	7311518201357	346	15	1	144
A0320M03X	7311518197773	346	15	1	146
A0408F03D	7311518197926	346	15	1	146
A0610F06D	7311518197933	346	15	1	146
A0613M03X	7311518197872	346	15	1	144
A0616AL06E	7311518181802	346	15	1	143
A0616C06	7311518023782	346	15	1	144
A0616F06	7311518023720	346	15	1	144
A0616M06	7311518023737	346	15	1	144
A0616M06DE	7311518212629	346	15	1	144
A0616M06E	7311518023751	346	15	1	144
A0616M06X	7311518023768	346	15	1	144
A0616M06XE	7311518181468	346	15	1	144
A0625M06X	7311518197780	346	15	1	146
A0810F06D	7311518197957	346	15	1	146
A0820C06	7311518023850	346	15	1	144
A0820F06	7311518023799	346	15	1	144
A0820F06E	7311518212803	346	15	1	144
A0820M06	7311518023805	346	15	1	144
A0820M06E	7311518023829	346	15	1	144
A0820M06X	7311518023836	346	15	1	144
A0820M06XE	7311518181994	346	15	1	144
A1020C06	7311518023928	346	15	1	144
A1020F06	7311518023867	346	15	1	144
A1020M06	7311518023874	346	15	1	144
A1020M06E	7311518023898	346	15	1	144
A1020M06X	7311518023904	346	15	1	144
A1020M06XE	7311518182007	346	15	1	144
A1040M06X	7311518233129	346	15	1	144
A1050M06X	7311518233136	346	15	1	144
A1225AL06E	7311518187620	346	15	1	143
A1225AL08E	7311518181819	346	15	1	143
A1225C06	7311518023997	346	15	1	144
A1225C08	7311518100544	346	15	1	144
A1225F06	7311518023935	346	15	1	144
A1225F06E	7311518212810	346	15	1	144
A1225F08	7311518024000	346	15	1	144
A1225M06	7311518023942	346	15	1	144
A1225M06DE	7311518212636	346	15	1	144
A1225M06E	7311518023966	346	15	1	144
A1225M06X	7311518023973	346	15	1	144
A1225M06XE	7311518182014	346	15	1	144
A1225M08	7311518100506	346	15	1	144
A1225M08E	7311518100520	346	15	1	144
A1225M08X	7311518187989	346	15	1	144
A1225M08XE	7311518192174	346	15	1	144
A1625C06	7311518192204	346	15	1	144
A1625C08	7311518100612	346	15	1	144
A1625F06	7311518192198	346	15	1	144
A1625F08	7311518100551	346	15	1	144
A1625M06	7311518192181	346	15	1	144
A1625M06X	7311518187361	346	15	1	144
A1625M06XE	7311518187354	346	15	1	144
A1625M08	7311518100568	346	15	1	144
A1625M08E	7311518100582	346	15	1	144
A1625M08X	7311518100599	346	15	1	144
A1625M08XE	7311518182021	346	15	1	144
A6700DM-10	7314151821722	354	10	5	64



CUENTA SUBGRUPO



A6700DM-11	7314151821739	354	10	5	64
A6700DM-12	7314151821746	354	10	5	64
A6700DM-13	7314151821753	354	10	5	64
A6700DM-14	7314151821760	354	10	5	64
A6700DM-5	7314150220632	354	10	5	64
A6700DM-5.5	7314151821678	354	10	5	64
A6700DM-6	7314151821685	354	10	5	64
A6700DM-7	7314151821692	354	10	5	64
A6700DM-8	7314151821708	354	10	5	64
A6700DM-9	7314151821715	354	10	5	64
A6700DZ-1/2	7314151751883	354	10	5	64
A6700DZ-1/4	7314151751371	354	10	5	64
A6700DZ-11/32	7314151819842	354	10	5	64
A6700DZ-3/16	7314151751029	354	10	5	64
A6700DZ-3/8	7314151751616	354	10	5	64
A6700DZ-5/16	7314151751531	354	10	5	64
A6700DZ-7/16	7314151819859	354	10	5	64
A6700DZ-7/32	7314151751296	354	10	5	64
A6700DZ-9/16	7314151751968	354	10	5	64
A6700DZ-9/32	7314151751456	354	10	5	64
A6709M-2.5	7314151753740	354	10	1	68
A6709M-3	7314151753825	354	10	1	68
A6709M-4	7314151754129	354	10	1	68
A6709M-5	7314151754471	354	10	1	68
A6709M-6	7314151754556	354	10	1	68
A6709Z-1/8	7314151755447	354	10	1	68
A6709Z-3/16	7314151755874	354	10	1	68
A6709Z-5/32	7314151755799	354	10	1	68
A6709Z-9/64	7314151755522	354	10	1	68
A6710DM-10	7314151756765	354	10	1	65
A6710DM-11	7314151756840	354	10	1	65
A6710DM-12	7314151756925	354	10	1	65
A6710DM-13	7314151757069	354	10	1	65
A6710DM-14	7314151757144	354	10	1	65
A6710DM-5.5	7314151756178	354	10	1	65
A6710DM-6	7314151756253	354	10	1	65
A6710DM-7	7314151756338	354	10	1	65
A6710DM-8	7314151756413	354	10	1	65
A6710DM-9	7314151756680	354	10	1	65
A6710DZ-1/2	7314151820466	354	10	1	65
A6710DZ-1/4	7314151757229	354	10	1	65
A6710DZ-11/32	7314151757571	354	10	1	65
A6710DZ-3/16	7314151820435	354	10	1	65
A6710DZ-3/8	7314151757656	354	10	1	65
A6710DZ-5/16	7314151757496	354	10	1	65
A6710DZ-7/16	7314151757731	354	10	1	65
A6710DZ-7/32	7314151820442	354	10	1	65
A6710DZ-9/16	7314151820473	354	10	1	65
A6710DZ-9/32	7314151820459	354	10	1	65
A6716DM	7314151820824	354	25	1	70
A6716DZ	7314151820831	354	25	1	72
A6718DZ	7314150312450	354	25	1	72
A6800DM-10	7314151821845	354	10	1	65
A6800DM-11	7314151821852	354	10	1	65
A6800DM-12	7314151821869	354	10	1	65
A6800DM-13	7314151821876	354	10	1	65
A6800DM-14	7314151821883	354	10	1	65
A6800DM-4	7314151821777	354	10	1	65
A6800DM-5	7314151821784	354	10	1	65
A6800DM-5.5	7314151821791	354	10	1	65
A6800DM-6	7314151821807	354	10	1	65
A6800DM-7	7314151821814	354	10	1	65
A6800DM-8	7314151821821	354	10	1	65
A6800DM-9	7314151821838	354	10	1	65
A6800DZ-1/2	7314151758899	354	10	1	65
A6800DZ-1/4	7314151758387	354	10	1	65
A6800DZ-11/32	7314151803872	354	10	1	65
A6800DZ-3/16	7314151758035	354	10	1	65
A6800DZ-3/8	7314151758622	354	10	1	65
A6800DZ-5/16	7314151758547	354	10	1	65
A6800DZ-7/16	7314151803889	354	10	1	65
A6800DZ-7/32	7314151758110	354	10	1	65
A6800DZ-9/16	7314151758974	354	10	1	65
A6800DZ-9/32	7314151758462	354	10	1	65
A6800SM-10	7314150360147	354	10	1	65
A6800SM-11	7314150360154	354	10	1	65
A6800SM-12	7314150360161	354	10	1	65
A6800SM-13	7314150360178	354	10	1	65
A6800SM-14	7314150360185	354	10	1	65
A6800SM-15	7314150360192	354	10	1	65
A6800SM-4	7314150360208	354	10	1	65
A6800SM-4.5	7314150360215	354	10	1	65
A6800SM-5	7314150360222	354	10	1	65
A6800SM-6	7314150360239	354	10	1	65
A6800SM-7	7314150360246	354	10	1	65
A6800SM-8	7314150360253	354	10	1	65
A6800SM-9	7314150360260	354	10	1	65
A6800SZ-1/8	7				



CUENTA SUBGRUPO



A7400DM-19	7314151820060	354	10	5	76
A7400DM-20	7314151820077	354	10	5	76
A7400DM-21	7314151820084	354	10	5	76
A7400DM-22	7314151820091	354	10	5	76
A7400DM-24	7314150386123	354	10	5	76
A7400DM-6	7314150118212	354	10	5	76
A7400DM-7	7314150118229	354	10	5	76
A7400DM-8	7314150118236	354	10	5	76
A7400DM-9	7314151819965	354	10	5	76
A7400DZ-1/2	7314151759780	354	10	5	76
A7400DZ-1/4	7314151759193	354	10	5	76
A7400DZ-11/16	7314151819897	354	10	5	76
A7400DZ-13/16	7314151819910	354	10	5	76
A7400DZ-17/32	7314151819866	354	10	5	76
A7400DZ-19/32	7314151819873	354	10	5	76
A7400DZ-3/4	7314151819903	354	10	5	76
A7400DZ-3/8	7314151759438	354	10	5	76
A7400DZ-5/16	7314151759278	354	10	5	76
A7400DZ-5/8	7314151819880	354	10	5	76
A7400DZ-7/16	7314151759513	354	10	5	76
A7400DZ-7/8	7314151819927	354	10	5	76
A7400DZ-9/16	7314151759865	354	10	5	76
A7402DM-10	7314151820138	354	10	1	77
A7402DM-11	7314151820145	354	10	1	77
A7402DM-12	7314151820152	354	10	1	77
A7402DM-13	7314151820169	354	10	1	77
A7402DM-14	7314151820176	354	10	1	77
A7402DM-15	7314151820183	354	10	1	77
A7402DM-16	7314151820190	354	10	1	77
A7402DM-17	7314151820206	354	10	1	77
A7402DM-18	7314151820213	354	10	1	77
A7402DM-19	7314151820220	354	10	1	77
A7402DM-21	7314150385881	354	10	1	77
A7402DM-7	7314150220243	354	10	1	77
A7402DM-8	7314150220250	354	10	1	77
A7402DM-9	7314150220267	354	10	1	77
A7402DZ-1/2	7314151760526	354	10	1	77
A7402DZ-1/4	7314151759940	354	10	1	77
A7402DZ-11/16	7314151820114	354	10	1	77
A7402DZ-13/16	7314153003027	354	10	1	77
A7402DZ-19/32	7314153003041	354	10	1	77
A7402DZ-3/4	7314151820121	354	10	1	77
A7402DZ-3/8	7314151760366	354	10	1	77
A7402DZ-5/16	7314151760014	354	10	1	77
A7402DZ-5/8	7314151820107	354	10	1	77
A7402DZ-7/16	7314151760441	354	10	1	77
A7402DZ-7/8	7314153003034	354	10	1	77
A7402DZ-9/16	7314151760793	354	10	1	77
A7410DZ-1/2	7314153006301	354	10	1	76
A7410DZ-11/16	7314153006332	354	10	1	76
A7410DZ-3/4	7314153006349	354	10	1	76
A7410DZ-3/8	7314153006288	354	10	1	76
A7410DZ-5/16	7314153006271	354	10	1	76
A7410DZ-5/8	7314153006325	354	10	1	76
A7410DZ-7/16	7314153006295	354	10	1	76
A7410DZ-9/16	7314153006318	354	10	1	76
A7435DME	7314153015006	354	25	1	82
A7440DME	7314153015419	354	25	1	82
A7440DZE	7314153014993	354	25	1	82
A7535DZE	7314153015013	354	25	1	83
ADJUST 9031/29	7314150320925	310	10	3	39
ADJUST3	7314150103515	310	10	1	39
ADJUST3-90	7314150236336	310	10	1	38
AP-234-F	7311518289027	352	30	2	563
AP-3M	7311518152062	352	30	1	563
AP-5M	7311518152079	352	30	1	563
APB260	7314150389162	358	20	10	550
APB360	7314150389186	358	20	10	550
AS-1200	7314150321520	336	10	3	488
AS-C33-JT-F	7314150341672	330	20	15	570
AS-C36-JT-M	7311518337490	330	20	15	570
AS-C39-JT-C	7314150341542	330	20	15	565
AS-C45-JT-C	7314150341559	330	20	15	565
ASP-1850	7311518337124	352	30	1	563
ASP-1850G	7311518337131	352	30	1	563
ASP-AS	7311518337377	330	20	4	564
ASP-AS-C33-JT-F	7314150341665	330	20	5	564
ASP-AS-C36-JT-M	7314150340590	330	20	5	564
ASP-AS-C39-JT-C	7314150341535	330	20	5	564
ASP-AS-C45-JT-C	7314150341566	330	20	2	564
ASP-AS-HOOK	7311518337582	352	30	4	563
ASP-ATP	7311518337384	352	30	4	564
ASP3740-C36JTM	7314150341818	352	30	1	564
ASP3740-C39JTC	7314150353347	352	30	1	564
ASP3740-C45JTC	7314150353354	352	30	1	564
ASP3740-P3437	7314150341801	352	30	1	563
ATP-110-210	7311518337575	352	30	1	563
ATP-230-410	7311518337599	352	30	2	563
B141.007.075	7314150278404	350	11	5	180
B141.008.075	7314150278411	350	11	5	180
B141.009.075	7314150278428	350	11	5	180
B141.010.075	7314150278435	350	11	5	180
B141.015.100	7314150278442	350	11	5	180
B141.020.100	7314150278459	350	11	5	180
B141.025.125	7314150278466	350	11	5	180
B141.027.125	7314150278473	350	11	5	180
B141.030.150	7314150278480	350	11	5	180
B141.040.150	7314150278497	350	11	5	180



CUENTA SUBGRUPO



B142.000.075	7314150278718	350	25	10	437
B142.001.080	7314150278725	350	25	10	437
B142.001.150	7314150343188	350	25	10	437
B142.002.100	7314150278732	350	25	10	437
B142.002.175	7314150343195	350	25	10	437
B142.003.150	7314150278749	350	25	10	437
B143.020.100	7314150278510	350	11	5	180
B143.025.100	7314150278503	350	11	10	180
B143.030.100	7314150278527	350	11	10	180
B143.040.100	7314150278534	350	11	10	180
B143.050.100	7314150278541	350	11	10	180
B143.060.125	7314150278558	350	11	10	180
B143.080.150	7314150278565	350	11	5	180
B144.001.100	7314150278787	350	11	5	180
B144.002.125	7314150278794	350	11	5	180
B144.003.150	7314150278800	350	11	5	180
B145.006.100	7314150278756	350	11	5	180
B146.006.100	7314150278763	350	11	5	180
B147.001.400	7314150285594	322	10	1	181
B147.003.400	7314150285600	322	10	1	181
B148.001.080	7314150314522	350	25	10	437
B148.002.100	7314150314539	350	25	10	437
B149.001.080	7314150314546	350	25	10	438
B149.002.100	7314150314553	350	25	10	438
B150.010.100	7314150343126	350	25	10	437
B150.015.125	7314150343133	350	25	10	437
B150.020.125	7314150343140	350	25	10	437
B150.025.150	7314150343157	350	25	10	437
B190.040.075	7314150277810	350	11	10	178
B190.040.100	7314150277827	350	11	10	178
B190.055.100	7314150277834	350	11	10	178
B190.055.125	7314150277841	350	11	10	178
B190.065.125	7314150277858	350	11	10	178
B190.065.150	7314150277865	350	11	10	178
B190.080.150	7314150277872	350	11	10	178
B190.080.175	7314150277889	350	11	10	178
B190.100.200	7314150277896	350	11	10	178
B190.120.250	7314150277902	350	11	10	178
B190.140.250	7314150277919	350	11	10	178
B191.025.075	7314150277926	350	11	10	178
B191.030.075	7314150277933	350	11	10	178
B191.030.100	7314150277940	350	11	10	178
B191.030.200	7314150277957	350	11	10	178
B191.035.100	7314150277964	350	11	10	178
B191.040.100	7314150277971	350	11	10	178
B191.040.125	7314150277988	350	11	10	178
B191.040.250	7314150277995	350	11	10	178
B191.055.125	7314150278008	350	11	10	178
B191.055.150	7314150278015	350	11	10	178
B191.055.300	7314150278022	350	11	10	178
B191.065.150	7314150278039	350	11	10	178
B191.065.300	7314150278046	350	11	10	178
B192.000.075	7314150278054	350	11	10	178
B192.000.200	7314150278091	350	11	10	178
B192.001.100	7314150278107	350	11	10	178
B192.001.250	7314150278114	350	11	10	178
B192.002.125	7314150278121	350	11	10	178
B192.002.300	7314150278138	350	11	10	178
B192.003.150	7314150278145	350	11	10	178
B192.004.200	7314150278169	350	11	10	178
B193.000.075	7314150278190	350	11	10	179
B193.001.100	7314150278206	350	11	10	179
B193.002.125	7314150278213	350	11	10	179
B193.003.150	7314150278220	350	11	10	179
B193.004.200	7314150278237	350	11	10	179
B194.004.075	7314150278268	350	11	10	179
B194.005.075	7314150278275	350	11	10	179
B194.006.075	7314150278282	350	11	10	179
B194.007.075	7314150278299	350	11	10	179
B194.008.075	7314150278305	350	11	10	179
B194.009.075	7314150278312	350	11	10	179
B194.010.075	7314150278329	350	11	10	179
B194.015.100	7314150278336	350	11	10	179
B194.020.100	7314150278343	350	11	10	179
B194.025.125	7314150278350	350	11	10	179
B194.027.125	7314150278367	350	11	10	179
B194.030.150	7314150278374	350	11	10	179
B194.040.150	7314150278381	350	11	10	179
B194.045.150	7314150278398	350	11	5	179
B195.001.025	7314150278176	350	11	10	179
B195.002.025	73141502781				

B197.001.150

CUENTA		SUBGRUPO			
B197.001.150	7314150343164	350	25	10	437
B197.002.100	7314150278688	350	25	10	437
B197.002.175	7314150343171	350	25	10	437
B197.003.150	7314150278695	350	25	10	437
B197.004.200	7314150278701	350	25	10	437
B198.040.125	7314150278817	350	11	5	181
B198.045.125	7314150278824	350	11	5	181
B198.050.150	7314150278831	350	11	5	181
B198.055.150	7314150281268	350	11	5	181
B198.060.150	7314150281763	350	11	5	181
B198.060.150F	7314150281770	350	11	5	181
B198.070.150	7314150281787	350	11	5	181
B198.070.150F	7314150281794	350	11	5	181
B198.080.150	7314150281800	350	11	5	181
B198.080.150F	7314150281817	350	11	5	181
B198.090.150	7314150281824	350	11	5	181
B198.100.150	7314150281831	350	11	5	181
B198.110.150	7314150281848	350	11	5	181
B198.120.150	7314150281855	350	11	5	181
B198.130.150	7314150281862	350	11	5	181
B198.140.150	7314150281879	350	11	5	181
B199.055.125	7314150281886	350	25	5	438
B199.060.125	7314150281893	350	25	5	438
B199.070.125	7314150281909	350	25	5	438
B199.080.125	7314150281916	350	25	5	438
B199.090.125	7314150281923	350	25	5	438
B199.100.125	7314150281930	350	25	5	438
B199.110.125	7314150281947	350	25	5	438
B199.120.125	7314150287741	350	25	5	438
B199.130.125	7314150287772	350	25	5	438
B219.002	7314150289301	350	11	1	181
B219.004	7314150283248	350	11	1	182
B219.005	7314150283255	350	11	1	182
B219.006	7314150283293	350	11	1	182
B219.007	7314150283323	350	11	1	183
B219.008	7314150283347	350	11	1	184
B219.010	7314150283354	350	11	1	184
B219.012	7314150327768	350	11	1	181
B219.015	7314150283262	350	11	1	182
B219.016	7314150283309	350	11	1	183
B219.017	7314150283330	350	11	1	183
B219.025	7314150283279	350	11	1	182
B219.026	7314150283316	350	11	1	183
B219.027	7314150399833	350	11	1	183
B219.035	7314150283286	350	11	1	182
B220.002	7314150289295	350	25	1	438
B220.005	7314150283361	350	25	1	438
B220.007	7314150283385	350	25	1	438
B220.012	7314150314614	350	25	1	438
B220.015	7314150283378	350	25	1	438
B220.017	7314150283392	350	25	1	438
B220.027	7314150283408	350	25	1	439
B400.002	8412814119441	338	20	1	546
B400.003	8412814119458	338	20	1	546
B400.004	8412814119465	338	20	1	546
B400.005	8412814119472	338	20	1	546
B400.006	8412814119489	338	20	1	546
B400.007	8412814119496	338	20	1	546
B400.008	8412814119502	338	20	1	546
B400.009	8412814119519	338	20	1	546
B400.010	8412814119526	338	20	1	546
B400.011	8412814119533	338	20	1	546
B400.012	8412814119540	338	20	1	546
B400.013	8412814119557	338	20	1	546
B400.014	8412814119564	338	20	1	546
B400.015	8412814119571	338	20	1	546
B400.016	8412814119588	338	20	1	546
B400.017	8412814119595	338	20	1	546
B400.018	8412814119601	338	20	1	546
B400.019	8412814119618	338	20	1	546
B400.020	8412814119625	338	20	1	546
B400.021	8412814119632	338	20	1	546
B400.022	8412814119649	338	20	1	546
B400.023	8412814119656	338	20	1	546
B400.024	8412814119663	338	20	1	546
B400.025	8412814119670	338	20	1	546
B400.026	8412814119687	338	20	1	546
B400.027	8412814119694	338	20	1	546
B400.028	8412814119700	338	20	1	546
B400.029	8412814119717	338	20	1	546
B400.030	8412814119724	338	20	1	546
B400.031	8412814119731	338	20	1	546
B400.032	8412814119748	338	20	1	546
B400.033	8412814119755	338	20	1	546
B400.034	8412814119762	338	20	1	546
B400.035	8412814119779	338	20	1	546
B400.036	8412814119786	338	20	1	546
B400.037	8412814119793	338	20	1	546
B400.038	8412814119809	338	20	1	546
B400.039	8412814119816	338	20	1	546
B400.040	8412814119823	338	20	1	546
B400.041	8412814119830	338	20	1	546
B400.042	8412814119847	338	20	1	546
B400.043	8412814119854	338	20	1	546
B400.044	8412814119861	338	20	1	546
B400.045	8412814119878	338	20	1	546
B400.046	8412814119885	338	20	1	546
B400.047	8412814119892	338	20	1	546

CUENTA		SUBGRUPO			
B400.048	8412814119908	338	20	1	546
B400.049	8412814119915	338	20	1	546
B400.050	8412814119922	338	20	1	546
B705.1/4.125	7314150281978	350	11	5	195
BAC007	7314150242337	312	40	1	279
BB10	7314150240586	312	10	1	309
BB1200A	7314150170173	312	10	1	307
BBA12-1200	7314150254330	312	10	1	307
BBA1224-1700	7314150254347	312	10	1	307
BBA1224-3200	7314150341955	312	10	1	307
BBBC2A	7314150181520	312	10	1	311
BBBC4A	7314150181537	312	10	1	311
BBBCAB-AUZ	7314150183944	312	10	1	311
BBBCAB-UK	7314150183937	312	10	1	311
BBC420	7314150243235	312	10	1	308
BBC620	7314150243242	312	10	1	308
BBCE12-10	7314150330263	312	10	1	308
BBCE12-15S	7314150406722	312	10	2	308
BBCE12-3	7314150330249	312	10	2	308
BBCE12-6	7314150330256	312	10	2	308
BBCE12-F100	7314150344710	312	10	1	308
BBCE24-10	7314150330287	312	10	2	308
BBCE612-2	7314150330195	312	10	2	307
BBCEC1	7314150335459	312	10	1	311
BBCEC2	7314150337460	312	10	1	311
BBCECER1	7314150335466	312	10	1	311
BBCECER2	7314150337484	312	10	1	311
BBH12-1200	7314150360734	312	10	1	307
BBJL1630	7314150244898	312	10	5	307
BBJL2535	7314150209453	312	10	1	307
BBJL3545	7314150209460	312	10	1	307
BBL12-40001	7314150335381	312	10	1	306
BBL12-40002	7314150335398	312	10	1	307
BBL12-40003	7314150335404	312	10	1	310
BBL12-40004	7314150335411	312	10	1	310
BBL12-40005	7314150335428	312	10	1	310
BBL12-40006	7314150335435	312	10	1	311
BBL12-40007	7314150335442	312	10	1	311
BBL800A	7314150255863	312	10	1	307
BBR100	7314150345922	312	25	1	298
BBR110	7314150170562	312	25	1	298
BBR201P6	7314150205752	312	25	8	296
BBR201P64014	7314150237852	312	25	1	296
BBR201P64016	7314150237753	312	25	1	296
BBR201P64018	7314150237760	312	25	1	296
BBR201P67814	7314150237777	312	25	1	296
BBR201P67816	7314150237784	312	25	1	296
BBR201P67818	7314150237791	312	25	1	296
BBR202P4	7314150205769	312	25	1	296
BBR202P410	7314150207688	312	25	1	296
BBR202P414	7314150207695	312	25	1	296
BBR202P419	7314150207701	312	25	1	296
BBR202P455	7314150231393	312	25	1	296
BBR203P9	7314150208081	312	25	1	296
BBR203P920	7314150231102	312	25	1	296
BBR203P925	7314150231119	312	25	1	296
BBR203P927	7314150231126	312	25	1	296
BBR203P930	7314150231133	312	25	1	296
BBR203P940	7314150231140	312	25	1	296
BBR203P945	7314150231157	312	25	1	296
BBR203P950	7314150231164	312	25	1	296
BBR203P955	7314150231171	312	25	1	296
BBR203P960	7314150231188	312	25	1	296
BBR210P3	7314150206056	312	25	1	296
BBR300P50	7314150269624	312	25	1	297
BBR320	7314150169887	312	25	1	297
BBR350	7314150169900	312	25	1	298
BBR400	7314150345939	312	25	1	297
BBR410	7314150345946	312	25	24	297
BBR420	7314150403394	336	20	50	297
BBR6131	7314150239443	312	25	1	296
BBR6135	7314150239450	312	25	1	296
BBRAS14	7314150416943	312	25	4	298
BBRBB12	7314150371297	312	25	1	298
BBRFKM1	7314150384938	312	25	12	297
BBRPTG1	7314150412617	312	25	10	298
BBRS210P	7314150206070	312	25	1	296
BBRS210P2	7314150206063	312	25	1	296
BBS075	7314150249824	312	20	12	315
BBS100	7314150169870	312	20	1	319
BBS10001	7314150207183	312	20	1	319
BBS10002	7314150207190	312	20	1	319
BBS10003	7314150207206	312	20	1	319
BBS10004	7314150207213	312	20	1	319
BBS10005	7314150207220	312	20	1	319
BBS100057	7314150186655	312	10	1	319
BBS10006	7314150207237	312	20	1	319
BBS10007	7314150207244	312	20	1	319
BBS10008	7314150207251	312	20	1	319
BBS10009	7314150207268	312	20	1	31



	CUENTA	SUBGRUPO			
BBS108	7314150250882	312	20	1	315
BBS12SH	7314150243563	312	20	1	316
BBS150	7314150169849	312	20	1	315
BBS150R	7314150244959	312	20	1	316
BBS150S	7314150244973	312	20	1	316
BBS150T	7314150244966	312	20	1	316
BBS165	7314150205615	312	20	10	315
BBS165SP4	7314150205622	312	20	50	315
BBS170P13	7314150205608	312	20	1	315
BBS170P131	7314150231843	312	20	1	315
BBS170P132	7314150231850	312	20	1	315
BBS170P133	7314150231867	312	20	1	315
BBS170P134	7314150231874	312	20	1	315
BBS170P135	7314150231881	312	20	1	315
BBS170P136	7314150231898	312	20	1	315
BBS170P137	7314150231904	312	20	1	315
BBS170P138	7314150231911	312	20	1	315
BBS170P139	7314150231928	312	20	1	315
BBS200	7314150239498	312	20	10	319
BBS20P12	7314150169856	312	20	1	318
BBS210	7314150215362	312	20	1	318
BBS210U06	7314150217656	312	20	1	318
BBS210U08	7314150217663	312	20	1	318
BBS210UA06	7314150217670	312	20	1	318
BBS210UA08	7314150217687	312	20	1	318
BBS210V06	7314150217632	312	20	1	318
BBS210V08	7314150217649	312	20	1	318
BBS210W06	7314150218738	312	20	1	318
BBS210W08	7314150218745	312	20	1	318
BBS3BH1	7314150356843	312	40	1	314
BBS3BH1-VP	7314150355501	312	40	40	314
BBS3UH	7314150242351	312	20	1	314
BBS50	7314150169863	312	20	1	306
BBS702026	7314150187416	312	10	15	311
BBS702028	7314150187423	312	10	1	312
BBSDA	7314150247127	312	20	1	316
BBSDC	7314150247158	312	20	6	317
BBSDD	7314150247165	312	20	1	317
BBSDH	7314150247141	312	20	1	317
BBSDHR	7314150249299	312	20	1	317
BBSDT	7314150247134	312	20	6	317
BBSDW	7314150247110	312	20	6	316
BBSH1F	7314150247189	312	20	1	316
BBSH1M	7314150247196	312	20	1	317
BBSH2C	7314150247202	312	20	1	317
BBSH2CA	7314150247219	312	20	12	317
BBSH2CP	7314150247226	312	20	6	318
BBSH2F	7314150247172	312	20	6	316
BBSH3CF	7314150247240	312	20	6	317
BBSH3CF30	7314150247264	312	20	6	318
BBSH3FS	7314150247257	312	20	6	317
BBSH3MF	7314150247233	312	20	1	317
BBSHWH1	7314150328932	312	20	1	318
BBSNL4FX001	7314150187492	312	10	1	312
BBSS1	7314150247288	312	20	1	316
BBSS2	7314150247271	312	20	8	316
BBSS2L	7314150247295	312	20	1	317
BBT20	7314150166961	312	10	1	309
BBT60	7314150327799	312	10	12	308
BBT80	7314150327805	312	10	6	308
BCL31B1	7314150389704	344	20	1	265
BCL31C1	7314150389742	344	20	1	265
BCL31D1	7314150389582	344	20	1	263
BCL31D1K1	7314150400843	344	20	1	263
BCL31IS1	7314150389599	344	20	1	263
BCL31IS1K1	7314150400836	344	20	1	263
BCL31IW1	7314150389551	344	20	1	262
BCL31IW1K1	7314150400829	344	20	1	262
BCL31R1	7314150389568	344	20	1	262
BCL31R1K1	7314150400850	344	20	1	263
BCL31SD1	7314150389575	344	20	1	263
BCL31SD1K1	7314150402656	344	20	1	263
BCL32B1	7314150389711	344	20	1	265
BCL32DG1	7314150389605	344	20	1	264
BCL32DG1K1	7314150402670	344	20	1	264
BCL32G1	7314150389629	344	20	1	265
BCL32G1K1	7314150400911	344	20	1	264
BCL32IW1	7314150389643	344	20	1	262
BCL32IW1K1	7314150402663	344	20	1	262
BCL32RS1	7314150389636	344	20	1	264
BCL32RS1K1	7314150400904	344	20	1	264
BCL32SP1	7314150389612	344	20	1	264
BCL32SP1K1	7314150400898	344	20	1	264
BCL33AP1	7314150389650	344	20	1	264
BCL33AP1K1	7314150402687	344	20	1	264
BCL33B1	7314150389728	344	20	1	265
BCL33B3	7314150389735	344	20	1	265
BCL33C1	7314150389759	344	20	1	265
BCL33C2	7314150389766	344	20	1	265
BCL33D1	7314150389681	344	20	1	263
BCL33D1K1	7314150400881	344	20	1	263
BCL33IW1	7314150389667	344	20	1	262
BCL33IW1K1	7314150400867	344	20	1	262
BCL33IW2	7314150389674	344	20	1	262
BCL33IW2K1	7314150400874	344	20	1	262
BE-3529	7314151847845	350	10	5	480
BE-6400M-4	7314153011145	350	10	5	175
BE-6400M-5	7314153011169	350	10	5	175



	CUENTA	SUBGRUPO			
BE-6400M-5.5	7314153011176	350	10	5	175
BE-6400M-7	7314153011190	350	10	5	175
BE-6902	7314150242641	350	10	5	172
BE-6903	7314150242665	350	10	5	172
BE-6925	7314150242658	350	10	5	172
BE-6990-IP10	7314151846763	360	25	1	122
BE-6990-IP10-KL	7314151847531	360	25	10	123
BE-6990-IP15	7314151846770	360	25	1	122
BE-6990-IP15-KL	7314151847548	360	25	10	123
BE-6990-IP20-KL	7314151848668	360	25	10	123
BE-6990-IP6	7314151846725	360	25	1	122
BE-6990-IP6-KL	7314151847494	360	25	10	123
BE-6990-IP7	7314151846732	360	25	1	122
BE-6990-IP7-KL	7314151847500	360	25	10	123
BE-6990-IP8	7314151846749	360	25	1	122
BE-6990-IP8-KL	7314151847517	360	25	10	123
BE-6990-IP9	7314151846756	360	25	1	122
BE-6990-IP9-KL	7314151847524	360	25	10	123
BE-6990-IPSET	7314153019356	360	25	1	122
BE-6990TX-T10KL	7314151847760	360	25	10	123
BE-6990TX-T15KL	7314151847777	360	25	10	123
BE-6990TX-T20KL	7314151848682	360	25	10	123
BE-6990TX-T6-KL	7314151847722	360	25	10	123
BE-6990TX-T7-KL	7314151847739	360	25	10	123
BE-6990TX-T8-KL	7314151847746	360	25	10	123
BE-6990TX-T9-KL	7314151847753	360	25	10	123
BE-7515	7314150242528	350	10	5	171
BE-7520	7314150242535	350	10	5	171
BE-7525	7314150242542	350	10	5	171
BE-7527	7314150242559	350	10	5	171
BE-7530	7314150242566	350	10	5	171
BE-7540	7314150242573	350	10	5	171
BE-7606	7314151839017	350	10	5	175
BE-7607	7314151839024	350	10	5	175
BE-7608	7314151839031	350	10	5	175
BE-7675	7314150123896	350	54	1	206
BE-7715	7314150242580	350	10	5	172
BE-7720	7314150242597	350	10	5	172
BE-7725	7314150242603	350	10	5	172
BE-7727	7314150242610	350	10	5	172
BE-7730	7314150242627	350	10	5	172
BE-7740	7314150242634	350	10	5	172
BE-7803	7314151838867	350	10	5	175
BE-7804	7314151838881	350	10	5	175
BE-7805	7314151838904	350	10	5	175
BE-7806	7314151838928	350	10	5	175
BE-7806S	7314150242986	350	24	5	436
BE-7807	7314151838935	350	10	5	175
BE-7807S	7314150242993	350	24	5	436
BE-7808	7314151838942	350	10	5	175
BE-7808S	7314150243006	350	24	5	436
BE-7809	7314151838959	350	10	5	175
BE-7809S	7314150243013	350	24	5	436
BE-7810	7314151838966	350	10	5	175
BE-7810S	7314150243020	350	24	5	436
BE-7811	7314151838973	350	10	5	175
BE-7812	7314151838980	350	10	5	175
BE-7813	7314151838997	350	10	5	175
BE-7814	7314151839000	350	10	5	175
BE-7835	7314151838874	350	10	5	175
BE-7845	7314151838898	350	10	5	175
BE-7855	7314151838911	350	10	5	175
BE-7855S	7314150242979	350	24	5	436
BE-7907	7314153010964	350	10	5	172
BE-7908	7314153010971	350	10	5	172
BE-7909	7314153010988	350	10	5	172
BE-7910	7314151838799	350	10	5	172
BE-7915	7314151838805	350	10	5	172
BE-7920	7314151838812	350	10	5	172
BE-7925	7314151838829	350	10	5	172
BE-7927	7314151838836	350	10	5	172
BE-7930	7314151838843	350	10	5	172
BE-7940	7314151838850	350	10	5	172
BE-8002	7314150242825	350	10	5	170
BE-8010	7314150010615	350	10	5	170
BE-8010S	7314150033058	350	24	5	434
BE-8020	7314150010639	350	10	5	170
BE-8020I	7314150270316	350	10	5	470
BE-8020L	7314151838591	350	10	5	170
BE-8022	7314150242474	350	10	5	170
BE-8030	7314150010653	350	10	5	170
BE-8030I	7314150270330	350	10	5	470
BE-8040	7314150010677	350	10	5	170
BE-8040I	7314150270347	350	10	5	470
BE-8040S	7314150033089	350	24	5	434
BE-8040SL	7314150304578	350	24	10	434
BE-8050S	7314150033096	350	24	5	434
BE-8050SL	7314150304592	350	24	10	434
BE-8065S	7314150033119	350	24	5	434
BE-8080-1	7314153010995	350	10	5	173
BE-8080-10	7314153011060	350	10	5	173
BE-8080-2	7314153011008	350	10	5	

BE-8145TB



CUENTA	SUBGRUPO				
BE-8145TB	7314150275076	350	10	10	187
BE-8150	7314150010707	350	10	5	170
BE-8150TB	7314150275113	350	10	10	187
BE-8155	7314150010721	350	10	5	170
BE-8155TB	7314150275090	350	10	5	187
BE-8158	7314153010858	350	10	5	170
BE-8159	7314153010865	350	10	5	170
BE-8160	7314150010745	350	10	5	170
BE-8210	7314151838584	350	10	5	170
BE-8220	7314150047741	350	10	5	170
BE-8220S	7314150048243	350	24	5	434
BE-8220SL	7314150304530	350	24	10	434
BE-8225	7314150242443	350	10	5	170
BE-8230	7314150047758	350	10	5	170
BE-8230S	7314150048250	350	24	5	434
BE-8230SL	7314150304554	350	24	10	434
BE-8235	7314150242450	350	10	5	170
BE-8240	7314150047765	350	10	5	170
BE-8241	7314150242467	350	10	5	170
BE-8241I	7314150270866	350	10	5	470
BE-8242	7314153010803	350	10	5	170
BE-8250	7314150047772	350	10	5	170
BE-8250L	7314151838607	350	10	5	170
BE-8251	7314150242481	350	10	5	170
BE-8252	7314153010810	350	10	5	170
BE-8252I	7314150270361	350	10	5	470
BE-8255	7314150047789	350	10	5	170
BE-8255S	7314150048281	350	24	5	434
BE-8255SL	7314150304615	350	24	10	434
BE-8256	7314153010827	350	10	5	170
BE-8256TB	7314150275137	350	10	5	187
BE-8257	7314153010834	350	10	5	170
BE-8258	7314153010841	350	10	5	170
BE-8258S	7314150242818	350	24	5	434
BE-8258TB	7314150275151	350	10	10	187
BE-8259S	7314150242832	350	24	5	434
BE-8260	7314150047796	350	10	5	170
BE-8262TB	7314150275526	350	10	10	187
BE-8330	7314151838614	350	10	5	170
BE-8340	7314151838621	350	10	5	170
BE-8350	7314151838638	350	10	5	170
BE-8355	7314151838652	350	10	5	170
BE-8360	7314151838676	350	10	5	170
BE-8450	7314151838645	350	10	5	170
BE-8455	7314151838669	350	10	5	170
BE-8510S	7314150126507	350	24	5	434
BE-8510SL	7314150304813	350	24	10	435
BE-8520S	7314150126514	350	24	5	434
BE-8520SL	7314150304837	350	24	10	435
BE-8571	7314150244652	350	10	1	174
BE-8572	7314150244669	350	10	1	174
BE-8573	7314150244676	350	10	1	174
BE-8574	7314150258666	350	10	1	175
BE-8575	7314150244638	350	10	1	174
BE-8576	7314150245741	350	10	1	175
BE-8577	7314151839048	350	10	5	174
BE-8600	7314150010769	350	10	5	170
BE-8600I	7314150270378	350	10	5	470
BE-8600S	7314150033126	350	24	5	434
BE-8601	7314151838706	350	10	5	171
BE-8602	7314151838713	350	10	5	171
BE-8605	7314150242498	350	10	5	170
BE-8608	7314150242504	350	10	5	170
BE-8610	7314150010776	350	10	5	170
BE-8610I	7314150270392	350	10	5	470
BE-8610L	7314151838683	350	10	5	171
BE-8610S	7314150033133	350	24	5	434
BE-8610SL	7314150304639	350	24	10	435
BE-8610TB	7314150275199	350	10	10	187
BE-8611	7311518292317	350	10	5	170
BE-8612S	7314150242856	350	24	5	434
BE-8620	7314150010783	350	10	5	171
BE-8620I	7314150270408	350	10	5	470
BE-8620L	7314151838690	350	10	5	171
BE-8620S	7314150033140	350	24	5	434
BE-8620SL	7314150304653	350	24	10	435
BE-8620TB	7314150275212	350	10	10	187
BE-8621	7311518292324	350	10	5	171
BE-8621S	7314150242863	350	24	5	434
BE-8622	7314150242511	350	10	5	171
BE-8622S	7314150242870	350	24	5	434
BE-8623	7314153010872	350	10	5	171
BE-8623I	7314150270415	350	10	5	470
BE-8623TB	7314150275236	350	10	10	187
BE-8624	7314153010889	350	10	5	171
BE-8624TB	7314150275250	350	10	10	187
BE-8628	7314153010896	350	10	5	171
BE-8629	7314153010902	350	10	5	171
BE-8630	7314150010790	350	10	5	171
BE-8630S	7314150033157	350	24	5	434
BE-8640	7314150010806	350	10	5	171
BE-8640S	7314150033164	350	24	5	434
BE-8675	7314150123872	350	54	1	205
BE-8700-1/4	7314150242689	350	10	5	172
BE-8700-3/16	7314150242696	350	10	5	172
BE-8700-3/8	7314150242702	350	10	5	172
BE-8700-5/16	7314150242719	350	10	5	172
BE-8700-5/32	7314150242726	350	10	5	172



CUENTA	SUBGRUPO				
BE-8700-7/32	7314150242733	350	10	5	172
BE-8700-7/64	7314150275878	350	10	5	172
BE-8702	7314151838768	350	10	5	172
BE-8703	7314150027651	350	10	5	172
BE-8703S	7314151839130	350	24	5	434
BE-8704	7314150027668	350	10	5	172
BE-8704S	7314151839147	350	24	5	434
BE-8705	7314150027675	350	10	5	172
BE-8705S	7314151839154	350	24	5	434
BE-8706	7314150027682	350	10	5	172
BE-8706S	7314151839161	350	24	5	434
BE-8708	7314150027699	350	10	5	172
BE-8708S	7314151839178	350	24	5	434
BE-8710	7314150027705	350	10	5	172
BE-8710S	7314150126521	350	24	5	434
BE-8710SL	7314150304851	350	24	10	435
BE-8715	7314150242672	350	10	5	172
BE-8720S	7314150126538	350	24	5	434
BE-8720SL	7314150304875	350	24	10	435
BE-8725	7314151838775	350	10	5	172
BE-8725S	7314151839123	350	24	5	434
BE-8800	7314150042012	350	10	5	171
BE-8800I	7314150270422	350	10	5	470
BE-8800S	7314151839055	350	24	5	434
BE-8801	7314151838744	350	10	5	171
BE-8802	7314151838751	350	10	5	171
BE-8810	7314150010813	350	10	5	171
BE-8810I	7314150270439	350	10	5	470
BE-8810L	7314151838720	350	10	5	171
BE-8810S	7314150048298	350	24	5	434
BE-8810SL	7314150304677	350	24	10	435
BE-8810TB	7314150275274	350	10	10	187
BE-8811	7311518292331	350	10	5	171
BE-8812S	7314150242894	350	24	5	434
BE-8820	7314150010820	350	10	5	171
BE-8820I	7314150270446	350	10	5	470
BE-8820L	7314151838737	350	10	5	171
BE-8820S	7314150048304	350	24	5	434
BE-8820SL	7314150304691	350	24	10	435
BE-8820TB	7314150275298	350	10	10	187
BE-8821	7311518292348	350	10	5	171
BE-8821S	7314150242900	350	24	5	434
BE-8822S	7314150242917	350	24	5	434
BE-8823	7314153010919	350	10	5	171
BE-8823I	7314150270453	350	10	5	470
BE-8823TB	7314150275311	350	10	10	187
BE-8824	7314153010926	350	10	5	171
BE-8824TB	7314150275335	350	10	10	187
BE-8828	7314153010933	350	10	5	171
BE-8829	7314153010940	350	10	5	171
BE-8830	7314150010837	350	10	5	171
BE-8830S	7314150048311	350	24	5	434
BE-8840	7314150010844	350	10	5	171
BE-8840S	7314151839062	350	24	5	434
BE-8865	7314150010851	350	10	5	170
BE-8870	7314150010875	350	10	5	170
BE-8880	7314150010899	350	10	5	170
BE-8890	7314150010905	350	10	5	170
BE-8904	7314153010957	350	10	5	172
BE-8905	7314153010049	350	10	5	172
BE-8905S	7314150242924	350	24	5	434
BE-8906	7314150027729	350	10	5	172
BE-8906S	7314150242931	350	24	5	434
BE-8907	7314150027736	350	10	5	172
BE-8907S	7314150242948	350	24	5	434
BE-8908	7314150027743	350	10	5	172
BE-8908S	7314150242955	350	24	5	434
BE-8909	7314150027750	350	10	5	172
BE-8909S	7314150242962	350	24	5	434
BE-8910	7314150027767	350	10	5	172
BE-8910I	7314150270460	350	10	5	470
BE-8910S	7314151839079	350	24	5	434
BE-8910SL	7314150304714	350	24	10	435
BE-8910TB	7314150275359	350	10	10	187
BE-8915	7314150027774	350	10	5	172
BE-8915I	7314150270477	350	10	5	470
BE-8915S	7314151839086	350	24	5	434
BE-8915SL	7314150304738	350	24	10	435
BE-8915TB	7314150275373	350	10	10	187
BE-8920	7314150027781	350	10	5	172
BE-8920I	7314150270484	350	10	5	470
BE-8920S	7314151839093	350	24	5	434
BE-8920SL	7314150304752	350	24	10	435
BE-8920TB	7314150275397	350	10	10	187
BE-8925	7314150027798	350	10	5	172
BE-8925I	7314150270491	350	10	5	470
BE-8925S	7314151839109	350	24	5	434
BE-8925SL	7314150304776	350	24	10	435
BE-8925TB	7314150275410	350	10	10	187
BE-8927	7314150027804	350	10	5	172
BE-8927TB	7314150275434	350	10	10	187



	CUENTA	SUBGRUPO			
BE-8975	7314150056576	350	54	6	205
BE-8975B	7314150188741	350	54	6	205
BE-8976B	7314150216369	350	54	6	205
BE-8980	7314153010681	350	10	5	173
BE-8985	7314153010698	350	10	5	173
BE-8986	7314150267026	350	10	5	173
BE-9001	7311518269005	350	10	5	173
BE-9002	7311518269012	350	10	5	173
BE-9003	7311518269029	350	10	5	173
BE-9100	7314150242757	350	10	5	173
BE-9101	7314150242764	350	10	5	173
BE-9102	7314150242771	350	10	5	173
BE-9103	7314150242788	350	10	5	173
BE-9104	7314150242795	350	10	5	173
BE-9105	7314150242801	350	10	5	173
BE-9575	7314150123841	350	54	1	205
BE-9578	7314150123803	350	54	1	202
BE-9585	7314150123858	350	54	1	206
BE-9586	7314150216000	350	54	1	202
BE-9588	7314150123810	350	54	1	203
BE-9675	7314150123889	350	54	1	205
BE-9676	7314150216017	350	54	1	204
BE-9678	7314150123827	350	54	1	204
BE-9688	7314150123834	350	54	1	204
BE-9765	7314150055128	350	54	3	204
BE-9770	7314150027712	350	54	3	204
BE-9770I	7314150276332	350	54	20	471
BE-9775	7314150056330	350	54	3	204
BE-9776	7314150056545	350	54	6	202
BE-9776B	7314150216352	350	54	6	203
BE-9777	7314150056552	350	54	6	202
BE-9777B	7314150188734	350	54	6	202
BE-9778	7314150123780	350	54	1	201
BE-9780	7314150033386	350	54	3	204
BE-9785	7314150056347	350	54	3	204
BE-9785I	7314150276349	350	54	1	470
BE-9786I	7314150314485	350	54	1	471
BE-9787	7314150056569	350	54	6	203
BE-9871	7314150234707	350	10	1	177
BE-9875	7314150314447	350	10	1	177
BE-9876S	7314150315000	350	24	1	177
BE-9877	7314150320745	350	10	1	177
BE-9878	7314150186259	350	54	1	201
BE-9878SL	7314150321018	350	10	1	436
BE-9880	7314150238569	350	54	3	203
BE-9880SL	7314150337651	350	24	1	435
BE-9881	7314150043279	350	10	1	176
BE-9881I	7314150270507	350	10	1	470
BE-9881S	7314151839307	350	24	1	436
BE-9881SL	7314150304899	350	24	1	436
BE-9881TB	7314150275502	350	10	1	188
BE-9882	7314151839284	350	10	1	176
BE-9882I	7314150270514	350	10	1	470
BE-9882S	7314151839314	350	24	1	436
BE-9882SL	7314150304912	350	24	1	436
BE-9882TB	7314150275496	350	10	1	188
BE-9884	7314150243068	350	10	1	176
BE-9884S	7314150236602	350	24	1	437
BE-9885	7314150048465	350	10	1	176
BE-9885S	7314150126491	350	24	1	436
BE-9885TB	7314150275519	350	10	1	188
BE-9886	7314150048472	350	10	1	176
BE-9887S	7314150244744	350	24	1	436
BE-9888S	7314153006158	350	24	1	436
BE-9889S	7314150244751	350	24	1	437
BE-9890S	7314150237715	350	24	1	437
BE-9890SL	7314150315086	350	24	1	435
BE-9891SL	7314150321506	350	24	1	435
BE-9894SL	7314150321490	350	24	1	435
BE100	7314150177912	312	10	1	271
BE1100	7314150205929	312	10	8	285
BE110001	7314150230228	312	10	1	285
BE110014	7314150230204	312	10	1	285
BE110015	7314150230211	312	10	1	285
BE1100AC1	7314150230266	312	10	1	285
BE1100AC2	7314150333394	312	10	1	285
BE1200P6	7314150205516	312	10	1	272
BE1200P6AC1	7314150205523	312	10	1	272
BE1205	7314150205554	312	10	1	280
BE1210P11	7314150209101	312	10	1	271
BE1210P1101	7314150269822	312	10	1	271
BE1210P1102	7314150269839	312	10	1	271
BE1210P1103	7314150269846	312	10	1	271
BE1300	7314150205578	312	30	1	281
BE1300SH	7314150205585	312	30	10	280
BE1305P450	7314150206032	312	30	1	281
BE1305P450WS01	7314150269228	312	30	1	281
BE1305P450WS02	7314150269235	312	30	1	281
BE1305P450WS03	7314150269242	312	30	1	281
BE1305P450WS04	7314150269237	312	30	1	281
BE1305P450WS05	7314150269334	312	30	1	281
BE1305P450WS06	7314150269341	312	30	1	281
BE1305P450WS07	7314150269358	312	30	1	281
BE1305P450WS08	7314150269365	312	30	1	281
BE1305P450WS09	7314150269372	312	30	1	281
BE1305P450WS10	7314150269310	312	30	1	281
BE1305P450WS11	7314150269389	312	30	1	281
BE1305P450WS12	7314150269396	312	30	1	281



	CUENTA	SUBGRUPO			
BE1305P450WS13	7314150269402	312	30	1	281
BE1305P450WS14	7314150269419	312	30	1	281
BE1305P450WS15	7314150269426	312	30	1	281
BE1310DNS	7314150403240	312	30	12	281
BE1310P4	7314150205707	312	30	1	279
BE1310P425	7314150233649	312	30	1	280
BE1310P427	7314150233656	312	30	1	280
BE1310P429	7314150233663	312	30	1	280
BE1310P430	7314150233670	312	30	1	280
BE1311P13	7314150235414	312	30	1	279
BE1315P7	7314150205776	312	30	1	280
BE1315P71	7314150230273	312	30	1	280
BE1315P72	7314150230280	312	30	1	280
BE1315P73	7314150230297	312	30	1	280
BE1315P74	7314150230303	312	30	1	280
BE1315P75	7314150230310	312	30	1	280
BE1315P76	7314150230327	312	30	1	280
BE1315P77	7314150230334	312	30	1	280
BE13ZL11	7314150239733	312	30	1	282
BE1FFWF	7314150403325	312	30	12	275
BE1FLD1	7314150250745	312	30	1	274
BE1FLD2	7314150250752	312	30	1	274
BE1FLD3	7314150250769	312	30	1	274
BE1FLDS	7314150250783	312	30	1	274
BE1FTW	7314150251209	312	30	1	274
BE1GP5	7314150170043	312	10	1	280
BE1GP5-T	7314150170050	312	10	10	280
BE1GP510	7314150207732	312	10	1	270
BE1GP512	7314150207749	312	10	1	270
BE1GP514	7314150207756	312	10	1	270
BE1GP58	7314150207718	312	10	1	270
BE1GP59	7314150207725	312	10	1	270
BE1P	7314150170067	312	10	1	282
BE1SP14L	7314150170074	312	10	1	283
BE1T14	7314150167630	312	10	1	284
BE1T16	7314150167647	312	10	1	284
BE1T21	7314150167654	312	10	1	284
BE1TH-10	7314150343980	312	30	5	289
BE1TH-12	7314150343997	312	30	5	289
BE1TH-14	7314150344000	312	30	5	289
BE1TH-2	7314150343874	312	30	10	289
BE1TH-2.5	7314150343881	312	30	10	289
BE1TH-3	7314150343898	312	30	10	289
BE1TH-3.5	7314150343904	312	30	10	289
BE1TH-4	7314150343911	312	30	10	289
BE1TH-4.5	7314150343928	312	30	10	289
BE1TH-5	7314150343935	312	30	10	289
BE1TH-6	7314150343942	312	30	10	289
BE1TH-7	7314150343959	312	30	10	289
BE1TH-8	7314150343966	312	30	10	289
BE1TH-9	7314150343973	312	30	10	289
BE1TH-S6	7314150344017	312	30	30	289
BE1TS-10	7314150344062	312	30	10	289
BE1TS-11	7314150344079	312	30	10	289
BE1TS-12	7314150344086	312	30	10	289
BE1TS-13	7314150344093	312	30	10	289
BE1TS-14	7314150344109	312	30	10	289
BE1TS-15	7314150344116	312	30	10	289
BE1TS-16	7314150344123	312	30	10	289
BE1TS-17	7314150344130	312	30	10	289
BE1TS-18	7314150344147	312	30	10	289
BE1TS-19	7314150344154	312	30	10	289
BE1TS-20	7314150344161	312	30	8	289
BE1TS-21	7314150344178	312	30	8	289
BE1TS-22	7314150344185	312	30	8	289
BE1TS-24	7314150344192	312	30	8	289
BE1TS-6	7314150344024	312	30	10	289
BE1TS-7	7314150344031	312	30	10	289
BE1TS-8	7314150344048	312	30	10	289
BE1TS-9	7314150344055	312	30	10	289
BE1TS-S7	7314150344208	312	30	6	289
BE200	7314150165148	312	30	5	332
BE200CAB250SH10	7314150165452	312	30	1	332
BE200CAB250SH25	7314150165469	312	30	1	332
BE200CAB250SH3	7314150165445	312	30	1	332
BE200CAB40F1	7314150165391	312	30	1	332
BE200CAB55F1	7314150165407	312	30	1	332
BE200CAB55F3	7314150165414	312	30	1	332
BE200CAB58SR1	7314150165421	312	30	1	332
BE200CAB58SR3	7314150165438	312	30	1	332
BE200CAB80SR1	7314150165384	312	30	1	332
BE200CAB80SR3	7314150165476	312	30	1	332
BE200MAG4	7314150245192	312	30	1	332
BE200MAG55	7314150165513	312	30	1	332
BE200MAG80	7314150165551	312	30	1	332
BE200MIR4035	7314150245161	312	30	1	332
BE200MIR4045	7314150245178	312	30	1	332
BE200MIR4055	7314150245185	312	30	1	332
BE200MIR5535	7314150165483	312	30	1	332
BE200MIR5545	7314150165490	312			

BE240



CUENTA SUBGRUPO



BE240	7314150239917	312	30	1	277
BE240-CAT	7314150289417	312	30	1	277
BE250	7314150169924	312	30	1	281
BE251	7314150239429	312	30	1	281
BE251200	7314150249343	312	25	1	304
BE2512005	7314150249350	312	25	1	304
BE2512008	7314150249367	312	25	1	304
BE253	7314150250806	312	30	1	281
BE2541	7314150251797	312	30	1	272
BE2542	7314150251803	312	30	1	280
BE256-155	7314150205875	312	30	1	280
BE256-178	7314150205882	312	30	1	280
BE256-250	7314150205899	312	30	1	280
BE256M	7314150205851	312	30	1	268
BE256P3	7314150205868	312	30	1	280
BE257	7314150205844	312	30	8	279
BE25710	7314150230549	312	30	1	279
BE25718	7314150230532	312	30	1	279
BE2572	7314150230556	312	30	1	279
BE2576	7314150230525	312	30	1	279
BE258	7314150251780	312	30	1	278
BE310	7314150205943	312	30	8	305
BE400P24	7314150205806	312	30	1	286
BE400P2401	7314150230600	312	30	1	268
BE400P2402	7314150230617	312	30	1	268
BE400P2403	7314150230624	312	30	1	269
BE400P2404	7314150230631	312	30	1	283
BE400P2405	7314150230648	312	30	1	269
BE400P2406	7314150230655	312	30	1	269
BE400P2407	7314150230662	312	30	1	269
BE400P2408	7314150230679	312	30	1	283
BE400P2409	7314150230686	312	30	1	269
BE400P241	7314150230563	312	30	1	279
BE400P2410	7314150230693	312	30	1	269
BE400P2411	7314150230709	312	30	1	284
BE400P2412	7314150230716	312	30	1	284
BE400P2413	7314150230723	312	30	1	284
BE400P2414	7314150230730	312	30	1	284
BE400P2415	7314150230747	312	30	1	285
BE400P2416	7314150230754	312	30	1	285
BE400P2417	7314150230761	312	30	1	285
BE400P2418	7314150230778	312	30	1	285
BE400P2419	7314150230785	312	30	1	285
BE400P242	7314150230570	312	30	1	287
BE400P2420	7314150237647	312	30	1	280
BE400P243	7314150230587	312	30	1	268
BE400P244	7314150230594	312	30	1	282
BE401	7314150240593	312	30	1	278
BE410	7314150205813	312	30	4	271
BE4101	7314150230792	312	30	1	271
BE5008	7314150239344	312	30	1	282
BE5008-10	7314150239269	312	30	1	282
BE5008-15	7314150239276	312	30	1	282
BE5008-20	7314150239283	312	30	1	282
BE5008-25	7314150239290	312	30	1	282
BE5008-27	7314150239306	312	30	1	282
BE5008-30	7314150239313	312	30	1	282
BE5008-40	7314150239320	312	30	1	282
BE5008-45	7314150239337	312	30	1	282
BE500P24	7314150169955	312	30	1	278
BE500P2401	7314150209569	312	30	1	278
BE500P2402	7314150209682	312	30	1	278
BE500P2403	7314150209736	312	30	1	278
BE500P2404	7314150209729	312	30	1	278
BE500P2405	7314150209613	312	30	1	278
BE500P2406	7314150209804	312	30	1	278
BE500P2407	7314150209781	312	30	1	278
BE500P2408	7314150209743	312	30	1	278
BE500P2409	7314150209750	312	30	1	278
BE500P2410	7314150209637	312	30	1	278
BE500P2411	7314150209644	312	30	1	278
BE500P2412	7314150209699	312	30	1	278
BE500P2413	7314150209705	312	30	1	278
BE500P2414	7314150209798	312	30	1	278
BE500P2415	7314150209675	312	30	1	278
BE500P2416	7314150209620	312	30	1	278
BE500P2417	7314150209583	312	30	1	278
BE500P2418	7314150209576	312	30	1	278
BE500P2419	7314150209767	312	30	1	278
BE500P2420	7314150209590	312	30	1	278
BE500P2421	7314150209606	312	30	1	278
BE500P2422	7314150209774	312	30	1	278
BE500P2423	7314150209668	312	30	1	278
BE500P2424	7314150209712	312	30	1	278
BE501101	7314150274499	312	30	1	268
BE501102	7314150274505	312	30	1	268
BE501203	7314150274529	312	30	1	268
BE501204	7314150274536	312	30	1	269
BE502101	7314150274543	312	30	1	269
BE502102	7314150274550	312	30	1	270
BE502103	7314150274567	312	30	1	270
BE502104	7314150384952	312	30	8	268
BE502106	7314150403370	312	30	10	269
BE502204	7314150274574	312	30	1	270
BE5032	7314150189885	312	30	1	286
BE503201	7314150274581	312	30	1	287
BE5032H10EL	7314150220953	312	30	1	270
BE5032H14	7314150220960	312	30	1	286



CUENTA SUBGRUPO



BE5032M14	7314150220977	312	30	1	286
BE5032SQ10	7314150220991	312	30	1	286
BE5032SQ8	7314150220984	312	30	1	286
BE5032T55EL	7314150220946	312	30	1	288
BE504102	7314150274666	312	30	1	270
BE504201	7314150274369	312	30	1	271
BE5049	7314150169931	312	30	5	286
BE504901	7314150184576	312	30	1	286
BE504902	7314150184583	312	30	1	287
BE5049H10	7314150184705	312	30	1	286
BE5049H10L	7314150184712	312	30	1	287
BE5049H12	7314150184729	312	30	1	286
BE5049H12L	7314150184736	312	30	1	287
BE5049H4	7314150184590	312	30	1	286
BE5049H4L	7314150184606	312	30	1	287
BE5049H5	7314150184613	312	30	1	286
BE5049H5L	7314150184620	312	30	1	287
BE5049H6	7314150184637	312	30	1	286
BE5049H6L	7314150184651	312	30	1	287
BE5049H7	7314150184668	312	30	1	286
BE5049H7L	7314150184675	312	30	1	287
BE5049H8	7314150184682	312	30	1	286
BE5049H8L	7314150184699	312	30	1	287
BE5049M10	7314150184804	312	30	1	286
BE5049M10L	7314150184811	312	30	1	288
BE5049M12	7314150184828	312	30	1	286
BE5049M12L	7314150184835	312	30	1	288
BE5049M5	7314150184743	312	30	1	286
BE5049M5L	7314150184750	312	30	1	288
BE5049M6	7314150184767	312	30	1	286
BE5049M6L	7314150184774	312	30	1	288
BE5049M8	7314150184781	312	30	1	286
BE5049M8L	7314150184798	312	30	1	288
BE5049T	7314150325474	312	30	1	288
BE5049T20	7314150216048	312	30	1	286
BE5049T20H	7314150184842	312	30	1	287
BE5049T20HL	7314150184859	312	30	1	288
BE5049T20L	7314150221011	312	30	1	288
BE5049T25	7314150216055	312	30	1	286
BE5049T25H	7314150184866	312	30	1	287
BE5049T25HL	7314150184873	312	30	1	288
BE5049T25L	7314150221028	312	30	1	288
BE5049T27	7314150216062	312	30	1	286
BE5049T27H	7314150184880	312	30	1	287
BE5049T27HL	7314150184897	312	30	1	288
BE5049T27L	7314150221035	312	30	1	288
BE5049T30	7314150216079	312	30	1	287
BE5049T30H	7314150184903	312	30	1	287
BE5049T30HL	7314150184910	312	30	1	288
BE5049T30HXL	7314150184927	312	30	1	288
BE5049T30L	7314150221042	312	30	1	288
BE5049T40	7314150216086	312	30	1	287
BE5049T40H	7314150184934	312	30	1	287
BE5049T40HL	7314150184941	312	30	1	288
BE5049T40HXL	7314150185092	312	30	1	288
BE5049T40L	7314150221059	312	30	1	288
BE5049T45	7314150216093	312	30	1	287
BE5049T45H	7314150184958	312	30	1	287
BE5049T45HL	7314150184965	312	30	1	288
BE5049T45HXL	7314150184972	312	30	1	288
BE5049T45L	7314150216123	312	30	1	288
BE5049T50	7314150216109	312	30	1	287
BE5049T50H	7314150184989	312	30	1	287
BE5049T50HL	7314150184996	312	30	1	288
BE5049T50L	7314150221066	312	30	1	288
BE5049T55	7314150216116	312	30	1	287
BE5049T55H	7314150185009	312	30	1	287
BE5049T55HL	7314150185016	312	30	1	288
BE5049T55L	7314150221073	312	30	1	288
BE5049T60	7314150221004	312	30	1	287
BE5049T60H	7314150185023	312	30	1	287
BE5049T60HL	7314150185030	312	30	1	288
BE5049T70HL	7314150185047	312	30	1	288
BE5049T80HL	7314150186532	312	30	1	288
BE505101	7314150274598	312	30	1	271
BE505102	7314150274604	312	30	1	271
BE505203	7314150274611	312	30	1	272
BE505204	7314150274628	312	30	1	272
BE506101	7314150274376	312	30	1	272
BE506102	7314150274635	312	30	1	272
BE506103	7314150274642	312	30	1	273
BE506204	7314150274659	312	30	1	273
BE507101	7314150274673	312	30	1	273
BE507102	7314150274680	312	30	1	273
BE507203	7314150274697	312	30	1	273
BE508101	7314150274765	312	3		



CUENTA SUBGRUPO



BE510102	7314150274437	312	30	1	276
BE510125	7314150230877	312	30	1	288
BE510127	7314150230884	312	30	1	288
BE510130	7314150230891	312	30	1	288
BE510140	7314150230907	312	30	1	288
BE510145	7314150230914	312	30	1	288
BE510150	7314150230921	312	30	1	288
BE510155	7314150230938	312	30	1	288
BE510160	7314150230945	312	30	1	288
BE5102	7314150205738	312	30	1	283
BE510203	7314150274789	312	30	1	276
BE510210	7314150231003	312	30	1	283
BE510211	7314150231010	312	30	1	283
BE510212	7314150231027	312	30	1	283
BE510213	7314150231034	312	30	1	283
BE51025	7314150230952	312	30	1	283
BE51026	7314150230969	312	30	1	283
BE51027	7314150230976	312	30	1	283
BE51028	7314150230983	312	30	1	283
BE51029	7314150230990	312	30	1	283
BE5103	7314150205745	312	30	1	283
BE510304	7314150274444	312	30	1	276
BE510310	7314150231072	312	30	1	284
BE510312	7314150231089	312	30	1	284
BE510314	7314150231096	312	30	1	284
BE51035	7314150231041	312	30	1	284
BE51036	7314150231058	312	30	1	284
BE51038	7314150231065	312	30	1	284
BE511101	7314150274451	312	30	1	276
BE511102	7314150274468	312	30	1	277
BE511203	7314150274796	312	30	1	277
BE512201	7314150274475	312	30	1	279
BE513201	7314150274802	312	10	1	277
BE5150P27	7314150205790	312	30	1	288
BE5150P271	7314150230808	312	30	1	288
BE5150P272	7314150230815	312	30	1	288
BE5150P273	7314150230822	312	30	1	288
BE5200	7314150205905	312	30	1	287
BE52001	7314150230433	312	30	1	287
BE52002	7314150230440	312	30	1	287
BE52003	7314150230457	312	30	1	287
BE523106	7314150178391	312	30	1	277
BE530001	7314150205912	312	30	1	287
BE5350	7314150206049	312	30	5	282
BE5350C1	7314150230389	312	30	1	282
BE5350C2	7314150230396	312	30	1	282
BE5350C3	7314150230402	312	30	1	282
BE5350C4	7314150230419	312	30	1	282
BE5350C5	7314150230426	312	30	1	282
BE5400P	7314150245086	312	30	1	288
BE5401D	7314150245062	312	30	1	283
BE5500	7314150403233	312	30	25	279
BE61110	7314150167449	312	30	1	290
BE61110-1	7314150167463	312	30	100	290
BE61155	7314150167456	312	30	1	290
BE61155-1	7314150167470	312	30	1	290
BE62110	7314150403332	312	30	10	290
BE62155	7314150403349	312	30	10	290
BE6217	7314150169702	312	30	1	292
BE621701	7314150232642	312	30	1	292
BE621702	7314150232659	312	30	1	292
BE621703	7314150232666	312	30	1	292
BE621704	7314150232673	312	30	1	292
BE621705	7314150232680	312	30	1	292
BE621706	7314150232697	312	30	1	292
BE621707	7314150232703	312	30	1	292
BE621708	7314150232710	312	30	1	292
BE621709	7314150232727	312	30	1	292
BE621710	7314150232734	312	30	1	292
BE621711	7314150232741	312	30	1	292
BE621712	7314150232758	312	30	1	292
BE621713	7314150232765	312	30	1	292
BE621714	7314150232772	312	30	1	292
BE621715	7314150232789	312	30	1	292
BE621716	7314150232796	312	30	1	292
BE621717	7314150232802	312	30	1	292
BE630	7314150169580	312	30	3	291
BE63010015F	7314150232598	312	30	25	291
BE63010615F	7314150232604	312	30	1	291
BE63010815F	7314150232611	312	30	1	291
BE63010818F	7314150232628	312	30	1	291
BE630246F	7314150169597	312	30	50	291
BE6302712F	7314150412846	312	30	5	292
BE630276F	7314150169603	312	30	50	291
BE630326F	7314150169610	312	30	50	291
BE630366F	7314150169627	312	30	100	291
BE630386F	7314150169634	312	30	50	291
BE63064514F1	7314150340095	312	30	1	292
BE63064514F2	7314150340101	312	30	1	292
BE6306514F	7314150232123	312	30	12	291
BE630656714F	7314150232130	312	30	12	291
BE63066514F	7314150169641	312	30	25	291
BE630666F	7314150232116	312	30	1	291
BE6306814F	7314150232154	312	30	1	291
BE6307314F	7314150232161	312	30	1	291
BE6307414F	7314150370108	312	30	10	292
BE6307415F	7314150232178	312	30	1	291
BE630747615F	7314150232307	312	30	12	291



CUENTA SUBGRUPO



BE630757715F	7314150232321	312	30	1	291
BE6307612F	7314150232345	312	30	12	291
BE6307614F	7314150232369	312	30	12	291
BE6307630F	7314150232437	312	30	1	291
BE630768F	7314150232468	312	30	1	291
BE6307815F	7314150232475	312	30	1	291
BE6308015F	7314150232482	312	30	1	291
BE630808215F	7314150232499	312	30	1	291
BE6308616F	7314150232505	312	30	1	291
BE6308618F	7314150232512	312	30	1	291
BE6309015F	7314150232529	312	30	1	291
BE6309210F	7314150232536	312	30	1	291
BE6309315F	7314150232543	312	30	1	291
BE6309336F	7314150232550	312	30	1	291
BE6309345F	7314150232567	312	30	1	291
BE6309515F	7314150232574	312	30	1	291
BE6309618F	7314150232581	312	30	1	291
BE64350	7314150169672	312	30	1	291
BE64350CH	7314150169696	312	30	1	291
BE64520	7314150169665	312	30	1	291
BE64520CH	7314150169689	312	30	1	291
BE65F65120	7314150169658	312	30	12	291
BE65R106160	7314150170036	312	30	1	291
BE65R65120	7314150170012	312	30	1	291
BE65R80120	7314150170029	312	30	1	291
BE66152	7314150247639	312	30	6	291
BE661521	7314150247646	312	30	8	291
BE6701VAG	7314150333875	312	30	1	292
BE68	7314150237876	312	30	1	292
BE6810	7314150237869	312	30	1	292
BE700	7314150206087	312	30	1	289
BE700BP2	7314150206100	312	30	1	289
BE700SP15	7314150206094	312	30	1	289
BE74-55100	7314150169733	312	30	1	287
BE74-57125	7314150169511	312	30	1	288
BE74-57125L	7314150169535	312	30	1	288
BE74-80120	7314150169740	312	30	1	287
BE74-90175	7314150169528	312	30	1	288
BE76101	7314150240005	312	30	1	288
BE76105	7314150239412	312	30	1	287
BE762	7314150384983	312	30	12	281
BE800P12	7314150205677	312	40	1	278
BELMS12	7314150239214	312	10	25	310
BELMS12OBDL	7314150340323	312	10	8	310
BELP1224	7314150177882	312	10	1	310
BELS12	7314150170579	312	10	1	310
BELT10	7314150170623	312	30	1	290
BELT1213	7314150170616	312	10	1	309
BELT127	7314150177899	312	10	1	309
BELT2415	7314150170609	312	10	1	309
BELT247N	7314150170586	312	10	1	309
BELT247S	7314150170593	312	10	1	309
BELTKEY	7314150177875	312	10	1	309
BELTRP16	7314150169917	312	10	1	310
BELTRP1601	7314150231935	312	10	1	310
BELTRP1602	7314150231942	312	10	1	310
BELTRP1603	7314150231959	312	10	1	310
BELTRP1604	7314150231966	312	10	1	310
BELTRP1605	7314150231973	312	10	1	310
BELTRP1606	7314150231980	312	10	1	310
BELTRP1607	7314150231997	312	10	1	310
BELTRP1608	7314150232000	312	10	1	310
BELTRP1609	7314150232017	312	10	1	310
BELTRP1610	7314150232024	312	10	1	310
BELTRP1611	7314150232031	312	10	1	310
BELTRP1612	7314150232048	312	10	1	310
BELTRP1613	7314150232062	312	10	1	310
BELTRP1614	7314150232079	312	10	1	310
BELTRP1615	7314150232086	312	10	1	310
BELTRP1616	7314150232093	312	10	1	310
BFRL11	7314150306534	344	35	1	328
BGIS125	7314150416431	312	20	20	319
BH110000A	7314150272709	312	40	1	322
BH110000A-02	7314150273669	312	40	1	322
BH110000A-04	7314150273683	312	40	1	322
BH110000A-EXT	7314150291946	312	40	1	322
BH11500	7314150178797	312	40	1	321
BH11500-01	7314150182220	312	40	1	322
BH11500-02	7314150182237	312	40	1	322
BH12000	7314150178803	312	40	1	321
BH13000	7314150178810	312	40	1	321
BH13000-02	7314150182244	312	40	1	322
BH13000L	7314150301980	312	40	1	321
BH13000L-01	7314150301997	312	40	1	322
BH13000QA	7314150403295	312	40	1	321
BH15000A	7314150272693	312	40	1	322
BH15000A-01	7314150273515	312	40	1	322
BH15000A-02					

BH1CD680



CUENTA SUBGRUPO



BH1CD680	7314150330379	312	40	1	324
BH1CD680ST	7314150330386	312	40	1	324
BH1EU3000	7314150245000	312	40	1	321
BH1EU3000-01	7314150250004	312	40	1	322
BH1EU3000-03	7314150249893	312	40	1	322
BH1EU3000-08	7314150249947	312	40	1	322
BH1M1000	7314150237845	312	40	1	320
BH1S45	7314150292295	312	40	1	322
BH1S45-01	7314150311194	312	40	1	322
BH1S45-03	7314150311217	312	40	1	322
BH230	7314150264070	312	40	1	322
BH23015	7314150178759	312	40	1	323
BH23015C	7314150178742	312	40	1	322
BH2402010	7314150178766	312	40	1	323
BH2604020	7314150178773	312	40	1	323
BH2AC1	7314150213474	312	40	1	323
BH2AC2	7314150213481	312	40	1	323
BH2AC60-140	7314150168958	312	40	1	323
BH2AC60V110	7314150178933	312	40	1	323
BH33000	7314150178674	312	40	1	324
BH36000	7314150178681	312	40	1	324
BH3A10000	7314150234660	312	40	1	325
BH3A3000	7314150234646	312	40	1	325
BH3A5000	7314150234653	312	40	1	325
BH3AL2500	7314150302420	312	40	1	325
BH3HD12000	7314150170500	312	40	1	324
BH3HD16000	7314150170524	312	40	1	325
BH3HD20000A	7314150337668	312	40	1	325
BH3HD8000	7314150170494	312	40	2	324
BH3SQ15000	7314150234684	312	40	2	325
BH3SQ7000	7314150234677	312	40	2	325
BH410	7314150178711	312	40	1	320
BH415	7314150178728	312	40	1	320
BH42	7314150178698	312	40	1	320
BH420	7314150178735	312	40	1	320
BH430	7314150178780	312	40	2	320
BH45	7314150178704	312	40	1	320
BH4S12	7314150237920	312	40	3	320
BH4S2	7314150237883	312	40	6	320
BH4S20	7314150237937	312	40	1	320
BH4S4	7314150237890	312	40	6	320
BH4S6	7314150237906	312	40	4	320
BH4S8	7314150237913	312	40	4	320
BH5DP1000QA	7314150270224	312	40	1	320
BH5SP500QA	7314150270217	312	40	1	320
BH5US1000	7314150243174	312	40	1	320
BH6FC1000	7314150178650	312	40	1	325
BH6FC2000	7314150234639	312	40	1	325
BH6PC600	7314150234622	312	40	1	325
BH7100A	7314150345908	312	40	1	312
BH7100SG	7314150299782	312	40	1	312
BH715	7314150237555	312	40	1	312
BH715-13	7314150239191	312	40	1	312
BH720	7314150235650	312	40	1	312
BH720-22	7314150236961	312	40	1	312
BH720SG	7314150238477	312	40	1	312
BH730	7314150235667	312	40	1	312
BH730SG	7314150238484	312	40	1	312
BH750	7314150235674	312	40	1	312
BH750SG	7314150238491	312	40	1	312
BH8AC1-500	7314150170463	312	30	1	324
BH8AC2-500	7314150412532	312	30	1	289
BH8AC3-1500	7314150292264	312	40	1	324
BH8AC3-600	7314150351893	312	40	1	324
BH8BC1	7314150242276	312	20	1	318
BH8BC2	7314150242283	312	20	1	318
BH8BC3	7314150242290	312	20	10	318
BH8BC4	7314150242306	312	20	6	319
BH8BC5	7314150242313	312	20	6	319
BH8PR10000	7314150178957	312	20	1	320
BH8PR4000	7314150178940	312	20	1	320
BH9BJ22SLH	7314150246946	312	40	1	323
BH9BJ22SSH	7314150247462	312	40	1	323
BH9BJ23SLH	7314150246953	312	40	1	323
BH9BJ23SSH	7314150246960	312	40	1	323
BH9BJ260	7314150247509	312	40	1	324
BH9BJ280	7314150247516	312	40	1	324
BHVG15-250	7314150403745	312	40	12	326
BHVIS06100	7314150167753	312	25	1	301
BHVIS06105	7314150167760	312	25	1	301
BHVIS0670	7314150167692	312	25	1	301
BHVIS0677	7314150167708	312	25	1	301
BHVIS0680	7314150167715	312	25	1	301
BHVIS0685	7314150167722	312	25	1	301
BHVIS0690	7314150167739	312	25	1	301
BHVIS0695	7314150167746	312	25	1	301
BHVIS08100	7314150165711	312	25	1	301
BHVIS08115	7314150165728	312	25	1	301
BHVIS0895	7314150165704	312	25	1	301
BHVIS109BPW12	7314150165759	312	25	1	301
BHVIS111BPW12	7314150165735	312	25	1	301
BHVIS120BPW16	7314150165742	312	25	1	301
BHVIS1265	7314150167685	312	25	1	301
BHVIS80BPW12	7314150165766	312	25	1	301
BHVIS95BPW9	7314150243334	312	25	1	301
BL1FM	7314150242344	312	30	1	333
BLBT100	7314150179015	312	40	1	313
BLBT100AC1	7314150179022	312	40	1	313



CUENTA SUBGRUPO



BLCR230FR	7314150247356	344	35	1	329
BLCR230SC	7314150247349	344	35	1	329
BLCR24VCL	7314150247370	344	35	1	329
BLCR24VLL	7314150247387	344	35	1	329
BLCR400E	7314150247363	344	35	1	329
BLCRSC1	7314150247530	344	10	1	329
BLCRSC2	7314150247547	344	10	1	329
BLE300	7314150227648	312	40	1	313
BLE301	7314150227662	312	40	1	314
BLE302	7314150227679	312	40	1	314
BLE304	7314150249572	312	40	1	314
BLE305	7314150339341	312	40	1	314
BLS128	7314150246847	344	35	20	328
BLE68	7314150246472	344	35	21	328
BLT550	7314150243556	312	30	10	278
BLTFC1	7314150246434	344	35	20	328
BLTFS6U	7314150246441	344	35	9	328
BLTI3P	7314150247608	344	35	18	328
BLTS10	7314150246427	344	35	20	328
BLTS61	7314150246458	344	35	15	328
BLTS7P	7314150246410	344	35	58	328
BLUVF	7314150247622	312	40	1	279
BLX128	7314150246397	344	35	10	329
BMD150	7314150242238	312	40	1	313
BMMTRMS1	7314150274024	312	10	1	309
BMR240	7314150242245	312	40	1	313
BOD101	7314150205967	312	30	1	293
BOD1016	7314150169979	312	30	1	295
BOD101NWS	7314150269099	312	30	1	293
BOD101T	7314150269150	312	30	1	295
BOD102	7314150205974	312	30	1	293
BOD102NWS	7314150269105	312	30	1	293
BOD102T	7314150269167	312	30	1	295
BOD103	7314150205981	312	30	1	293
BOD103NWS	7314150269112	312	30	1	293
BOD103T	7314150269174	312	30	1	295
BOD104	7314150205998	312	30	1	293
BOD104NWS	7314150269129	312	30	1	293
BOD104T	7314150269181	312	30	1	295
BOD105	7314150206001	312	30	1	293
BOD105NWS	7314150269136	312	30	1	293
BOD105T	7314150269198	312	30	1	295
BOD106	7314150206018	312	30	1	293
BOD106NWS	7314150269143	312	30	1	293
BOD106T	7314150269204	312	30	1	295
BOD10P64	7314150205950	312	30	1	293
BOD2008	7314150169986	312	30	1	295
BOD2FS	7314150351879	312	40	20	295
BOD301200	7314150169993	312	40	1	294
BOD4200	7314150169436	312	40	1	291
BOD4500	7314150169443	312	40	1	291
BOD54-1	7314150239467	312	40	1	295
BOD54-2	7314150239474	312	40	1	295
BOD54-3	7314150239481	312	40	1	295
BOD5400	7314150169450	312	40	1	295
BOD5450	7314150169474	312	40	1	295
BOD55HD400	7314150169467	312	40	1	295
BOD60	7314150169481	312	40	1	295
BOD6080P12	7314150235407	312	40	1	293
BOD6080P12-01	7314150235438	312	40	1	294
BOD6080P12-02	7314150235445	312	40	1	294
BOD6080P12-03	7314150235452	312	40	1	294
BOD6080P12-04	7314150235469	312	40	1	294
BOD6080P12-05	7314150235476	312	40	1	294
BOD6080P12-06	7314150235490	312	40	1	294
BOD6080P12-07	7314150235506	312	40	1	294
BOD6080P12-08	7314150235513	312	40	1	294
BOD6080P12-09	7314150235520	312	40	1	294
BOD6080P12-10	7314150235537	312	40	1	294
BOD6080P12-11	7314150235544	312	40	1	294
BOD70	7314150169498	312	40	1	295
BOD8901	7314150169016	312	30	1	293
BOD8901AC1	7314150178490	312	30	1	293
BOD8902	7314150169023	312	30	1	293
BOD8903A	7314150265374	312	30	1	293
BP110	7314150135011	344	10	1	253
BP111E	7314150235872	344	10	12	256
BP115	7314150134991	344	10	1	253
BP117	7314150184309	344	10	1	253
BP117EH	7314150184316	344	10	1	253
BP118	7314150235834	344	10	1	253
BP125	7314150184323	344	10	1	257
BP127	7314150137565	344	10	1	254
BP204	7314150184286	344	10	1	255
BP20410320	7314150185948	344	10	1	255
BP20410800	7314150185955	344	10	1	255
BP20425180	7314150185924	344	10	1	255
BP20425220	7314150185931	344	10	1	255
BP204K	7314150184293	344	10	1	255
BP204PAD	7314150185917	344	10	1	255
BP212	7314150134601				



	CUENTA	SUBGRUPO			
BP254	7314150137633	344	10	1	258
BP255	7314150137640	344	10	1	258
BP420M	7314150134618	344	10	1	253
BP421M	7314150134625	344	10	1	253
BP422M	7314150134632	344	10	1	253
BP423M	7314150134649	344	10	1	254
BP424M	7314150134656	344	10	1	254
BP430M	7314150134663	344	10	1	254
BP431M	7314150134670	344	10	1	254
BP432M	7314150134687	344	10	1	254
BP433M	7314150134694	344	10	1	254
BP434M	7314150135837	344	10	1	254
BP500	7314150137992	344	10	1	258
BP51137	7314150134724	344	10	1	255
BP601	7314150134526	344	10	1	255
BP610	7314150134595	344	10	1	255
BP700	7314150134458	344	10	20	252
BP799	7314150134502	344	10	1	258
BP79912	7314150134717	344	10	1	258
BP809	7314150235841	344	10	1	254
BP80950	7314150275564	344	10	1	254
BP810	7314150235858	344	10	1	254
BP811	7314150235865	344	10	1	256
BP814	7314150184262	344	10	10	250
BP814A	7314150304349	344	10	10	250
BP815	7314150134311	344	10	1	250
BP815K1	7314150181957	344	10	1	251
BP815K2	7314150181964	344	10	1	251
BP817	7314150134106	344	10	1	251
BP820	7314150134465	344	10	1	252
BP821	7314150134472	344	10	1	252
BP822	7314150134984	344	10	1	253
BP822E	7314150184279	344	10	10	253
BP823	7314150135004	344	10	1	253
BP824	7314150134489	344	10	1	256
BP825	7314150134496	344	10	1	256
BP826	7314150137459	344	10	1	256
BP827	7314150137442	344	10	1	256
BP901	7314150336012	344	10	1	252
BP901L	7314150336029	344	10	1	252
BP905L	7314150336234	344	10	2	252
BP905P	7314150336210	344	10	2	252
BP905S	7314150336227	344	10	2	252
BP909AC1	7314150237401	344	10	1	257
BP909NE	7314150187980	344	10	1	257
BP909NF	7314150187973	344	10	1	257
BP909TE	7314150187942	344	10	1	257
BP909TF	7314150187911	344	10	1	257
BP909TH	7314150187959	344	10	1	257
BP909TSP	7314150187966	344	10	1	257
BP909TTP	7314150187935	344	10	1	257
BP909TWF	7314150187928	344	10	1	257
BP91BL	7314150192779	344	10	1	253
BP91BS	7314150192786	344	10	1	253
BPBG3515	7314150134823	344	10	1	256
BPBG3525A	7314150134830	344	10	1	256
BPBG3525B	7314150134847	344	10	1	256
BPBG5725	7314150134861	344	10	1	257
BPBG9057	7314150134878	344	10	1	257
BPBK30	7314150134854	344	10	1	256
BPBL00900	7314150358335	312	25	5	343
BPBL30900	7314150360451	312	25	5	343
BPBL70600	7314150360468	312	25	5	343
BPBL90600	7314150358366	312	25	5	343
BPBLS4	7314150360475	312	25	2	343
BPBSC156	7314150134816	344	10	1	256
BPBU18	7314150134755	344	10	1	256
BPBU24	7314150134762	344	10	1	256
BPBU36	7314150134779	344	10	1	256
BPBU60	7314150134786	344	10	1	256
BPBU90	7314150134793	344	10	1	256
BPC813	7314150296408	344	10	10	250
BPC813K1	7314150331253	344	10	1	250
BPC814	7314150296392	344	10	10	250
BPC815	7314150296385	344	10	1	250
BPC815K1	7314150331208	344	10	1	250
BPC815K2	7314150331215	344	10	1	251
BPC815K3	7314150331222	344	10	1	251
BPC815K4	7314150331239	344	10	1	251
BPC815K6	7314150331284	344	10	1	251
BPC816	7314150296415	344	10	10	250
BPC817	7314150296422	344	10	4	251
BPC817K1	7314150331260	344	10	1	251
BPC817K2	7314150331277	344	10	1	252
BPCVB1	7314150384792	312	25	6	304
BPH1010A	7314150330010	344	10	1	258
BPH1010B	7314150341757	344	10	1	258
BPH1310A	7314150330003	344	10	1	259
BPHRC1015	7314150247400	344	10	1	259
BPHRC1020	7314150247417	344	10	1	259
BPHRC1316	7314150247455	344	10	1	259
BPHRC815	7314150247394	344	10	1	259
BPHRO1315	7314150247431	344	10	1	259
BPHRSC	7314150247448	344	10	1	259
BPHVLP01	7314150138937	344	10	1	258
BPHVLP0110	7314150165865	344	10	1	258
BPHVLP0112	7314150165872	344	10	1	258
BPHVLP0114	7314150165889	344	10	1	258



	CUENTA	SUBGRUPO			
BPHVLP0117	7314150165896	344	10	1	258
BPHVLP0120	7314150165902	344	10	1	258
BPM917BOOT	7314150281664	344	10	1	252
BPM91MK1	7314150186938	344	10	1	252
BPM91MK2	7314150186945	344	10	1	252
BPNO10	7314150219728	344	10	1	259
BPN21201	7314150134731	344	10	1	256
BPN22201	7314150138074	344	10	1	256
BPN251	7314150137589	344	10	1	258
BPOC15	7314150360673	312	25	12	289
BPQCF14	7314150138920	344	10	10	259
BS1000	7314150170081	312	25	1	306
BS100001	7314150232819	312	25	1	306
BS100002	7314150232826	312	25	1	306
BS100003	7314150232833	312	25	1	306
BS100004	7314150232840	312	25	1	306
BS100005	7314150232857	312	25	1	306
BS100006	7314150232864	312	25	1	306
BS100007	7314150232871	312	25	1	306
BS100008	7314150232888	312	25	1	306
BS100009	7314150232895	312	25	1	306
BS100010	7314150232901	312	25	1	306
BS100011	7314150232918	312	25	1	306
BS100012	7314150232925	312	25	1	306
BS100013	7314150232932	312	25	1	306
BS100014	7314150232949	312	25	1	306
BS100015	7314150232956	312	25	1	306
BS100016	7314150232963	312	25	1	306
BS100017	7314150232970	312	25	1	306
BS100018	7314150232987	312	25	1	306
BS100019	7314150232994	312	25	1	306
BS100020	7314150233007	312	25	1	306
BS100021	7314150233014	312	25	1	306
BS100022	7314150233021	312	25	1	306
BS100023	7314150233038	312	25	1	306
BS100024	7314150233045	312	25	1	306
BS100025	7314150233052	312	25	1	306
BS100026	7314150233069	312	25	1	306
BS100027	7314150233076	312	25	1	306
BS100028	7314150233083	312	25	1	306
BS100029	7314150233090	312	25	1	306
BS100030	7314150233106	312	25	1	306
BS100031	7314150233113	312	25	1	306
BS100032	7314150233120	312	25	1	306
BS100033	7314150233137	312	25	1	306
BS100034	7314150233144	312	25	1	306
BS100035	7314150233151	312	25	1	306
BS100036	7314150233168	312	25	1	306
BS100037	7314150233175	312	25	1	306
BS100038	7314150233182	312	25	1	306
BS100039	7314150233199	312	25	1	306
BS100PSA1	7314150249282	312	25	1	303
BS10AC2	7314150182343	312	25	1	306
BS10MEC	7314150178834	312	25	1	305
BS15	7314150206117	312	25	1	305
BS15125	7314150231775	312	25	1	305
BS15125C	7314150231812	312	25	1	305
BS15160	7314150231782	312	25	1	305
BS15160C	7314150231829	312	25	1	305
BS15212	7314150231799	312	25	1	305
BS15212C	7314150231836	312	25	1	305
BS1550	7314150231805	312	25	1	305
BS20	7314150205592	312	25	1	305
BS20/S10	7314153009319	366	10	1	43
BS25	7314150416103	312	25	70	306
BS30	7314150346875	312	25	1	306
BS30AC1	7314150383504	312	25	1	306
BS52	7314150329212	312	25	1	304
BS5228341	7314150329229	312	25	1	303
BS5234401	7314150329236	312	25	1	303
BS5239451	7314150329243	312	25	1	303
BS54	7314150243341	312	25	1	299
BS618	7314150242368	312	25	1	303
BS623	7314150242375	312	25	1	303
BSSHE3	7314150251858	312	25	1	302
BT10P3	7314150205639	312	25	1	305
BT10P325	7314150231706	312	25	40	305
BT10P330	7314150231713	312	25	1	305
BT10P338	7314150231720	312	25	1	305
BT15P5	7314150205837	312	25	1	303
BT15P524	7314150231737	312	25	1	303
BT15P530	7314150231744	312	25	1	303
BT15P532	7314150231751	312	25	1	303
BT15P536	7314150342129	312	25	1	303
BT20P26	7314150205820	312	25	1	299
BT20P49	7314150385041	312	30	1	303
BTL-3-13	7314150333349	336	15	12	482
BTL-6-13	7314150333356	336	15	12	482
BTR-3-13	7314150333332	336	15	12	482
BTR-6-13	7314150333363	336	15	12	482
BUC100	7314150169962	312	30	1	290
BUC110	7314150206025	312	30	1	290
BUC50	7314150182329	312	30	1	290
BUCPE	7314150243259	312	30	1	290
BUCPE3SDH	7314153024183				



CUENTA SUBGRUPO



BWB14	7314150170166	312	25	1	303
BWB1418S4	7314150365593	312	40	6	314
BWB1922S4	7314150365609	312	40	6	314
BWBB	7314150407828	312	25	200	326
BWC1	7314150365586	312	25	25	313
BWHEHS	7314150251841	312	25	1	301
BWHEP	7314150251834	312	25	1	302
BWHEPS	7314150264087	312	25	1	302
BWHEPSH8	7314150264889	312	25	1	302
BWHEPSSH8	7314150264896	312	25	1	302
BWHPJ12	7314150403257	312	25	4	303
BWHTRS12	7314150384808	312	30	15	300
BWMSP15	7314150239740	312	40	1	341
BWMSP1501	7314150239757	312	40	1	341
BWMSP1502	7314150239764	312	40	1	341
BWMSP1503	7314150239771	312	40	1	341
BWMSP1504	7314150239788	312	40	1	341
BWMSP1505	7314150239795	312	40	1	341
BWMSP1506	7314150239801	312	40	1	341
BWMSP1507	7314150239817	312	40	1	341
BWMSP1508	7314150239818	312	40	1	341
BWMSP1509	7314150239825	312	40	1	341
BWMSP1510	7314150239832	312	40	1	341
BWMSP1511	7314150239849	312	40	1	341
BWMSP1512	7314150239856	312	40	1	341
BWMSP1513	7314150239863	312	40	1	341
BWMSP1514	7314150239870	312	40	1	341
BWMSP1515	7314150239887	312	40	1	341
BWP150	7314150170159	312	25	1	304
BWSH5	7314150251810	312	25	2	302
BWSH51	7314150251827	312	25	1	302
BWSH8	7314150255191	312	25	1	302
BWSHK21	7314150403271	312	25	25	299
BWSMB15	7314150365074	312	25	25	299
BWSMB17	7314150329656	312	25	1	299
BWSS12P3	7314150170128	312	25	20	299
BWSS12P317	7314150203451	312	25	1	300
BWSS12P317L	7314150330065	312	25	1	300
BWSS12P319	7314150203468	312	25	1	300
BWSS12P319L	7314150330072	312	25	1	300
BWSS12P321	7314150203475	312	25	1	300
BWSS12P321L	7314150330089	312	25	1	300
BWSS12P3L	7314150330096	312	25	1	302
BWSS12P5	7314150170135	312	25	1	299
BWSS12P522	7314150203482	312	25	1	300
BWSS12P524	7314150203499	312	25	1	300
BWTB12P100	7314150329830	312	25	1	300
BWTB12P110	7314150329847	312	25	1	300
BWTB12P120	7314150329854	312	25	1	300
BWTB12P135	7314150329861	312	25	1	300
BWTB12P150	7314150329878	312	25	1	300
BWTB12P160	7314150329885	312	25	1	300
BWTB12P175	7314150329892	312	25	1	300
BWTB12P190	7314150329908	312	25	1	300
BWTB12P200	7314150329915	312	25	1	300
BWTB12P5	7314150329991	312	25	1	300
BWTB12P90	7314150329823	312	25	1	300
BWTDG1	7314150403400	336	20	50	305
BWTPG1	7314150351886	312	40	10	298
BWTPMSS4C	7314150347100	312	25	25	299
BWTPMSS9	7314150347124	312	25	8	298
BWTSP16	7314150170296	312	25	1	301
BWTSP1608	7314150203284	312	25	1	301
BWTSP1610	7314150203291	312	25	1	301
BWTSP1611	7314150203307	312	25	1	301
BWTSP1612	7314150203314	312	25	1	301
BWTSP1613	7314150203321	312	25	1	301
BWTSP1614	7314150203338	312	25	1	301
BWTSP1616	7314150203345	312	25	1	301
BWTSP1617	7314150203352	312	25	1	301
BWTSP1618	7314150203369	312	25	1	301
BWTSP1619	7314150203376	312	25	1	301
BWTSP1621	7314150203383	312	25	1	301
BWTSP1622	7314150203390	312	25	1	301
BWTSP1624	7314150203406	312	25	1	301
BWTSP1627	7314150203413	312	25	1	301
BWTSP317L	7314150335480	312	25	1	300
BWTSP319L	7314150335497	312	25	1	300
BWTSP321L	7314150335503	312	25	1	300
BWTSP3L	7314150335473	312	25	1	301
BWTSP6	7314150240043	312	25	1	300
BWTSP617	7314150242399	312	25	1	300
BWTSP619	7314150242405	312	25	1	300
BWTSP621	7314150242412	312	25	1	300
BWTSP622	7314150242429	312	25	1	300
BWTSP624	7314150242436	312	25	1	300
BWTPS7	7314150170302	312	25	1	301
BWTPS732	7314150203420	312	25	1	301
BWTPS736	7314150203437	312	25	1	301
BWTPS741	7314150203444	312	25	1	301
BWTVCTT355	7314150347179	312	25	1	298
BWXW1	7314150167661	312	25	1	303
BWXW2	7314150167678	312	25	1	303
BWXW3	7314150214624	312	25	1	303
BWXW4	7314150214631	312	25	1	303
BZWTB0132450	7314150165674	312	25	1	299
BZWTB0132600	7314150165681	312	25	1	299
BZWTB0133600	7314150165698	312	25	1	299



CUENTA SUBGRUPO



C0313C03	7311518100643	346	15	1	144
C0313F03	7311518100629	346	15	1	144
C0313M03	7311518100636	346	15	1	144
C0313M03X	7311518182045	346	15	1	144
C0613M03X	7311518197889	346	15	1	144
C0616AL06	7311518181826	346	15	1	143
C0616C06	7311518100698	346	15	1	144
C0616F06	7311518100650	346	15	1	144
C0616M03X	7311518204679	346	15	1	144
C0616M06	7311518100667	346	15	1	144
C0616M06D	7311518215262	346	15	1	144
C0616M06X	7311518100681	346	15	1	144
C0820C06	7311518100742	346	15	1	144
C0820F06	7311518100704	346	15	1	144
C0820M06	7311518100711	346	15	1	144
C0820M06X	7311518100735	346	15	1	144
C1020C06	7311518100797	346	15	1	144
C1020F06	7311518100759	346	15	1	144
C1020M06	7311518100766	346	15	1	144
C1020M06X	7311518100780	346	15	1	144
C1225AL06	7311518187637	346	15	1	143
C1225AL08	7311518181833	346	15	1	143
C1225C06	7311518100841	346	15	1	144
C1225C08	7311518100889	346	15	1	144
C1225F06	7311518100803	346	15	1	144
C1225F08	7311518100858	346	15	1	144
C1225M06	7311518100810	346	15	1	144
C1225M06X	7311518100834	346	15	1	144
C1225M08	7311518100865	346	15	1	144
C1225M08X	7311518187996	346	15	1	144
C1625C06	7311518192273	346	15	1	144
C1625C08	7311518100933	346	15	1	144
C1625F06	7311518192259	346	15	1	144
C1625F08	7311518100896	346	15	1	144
C1625M06	7311518192266	346	15	1	144
C1625M06X	7311518187378	346	15	1	144
C1625M08	7311518100902	346	15	1	144
C1625M08X	7311518100926	346	15	1	144
C3140	7314150393312	340	10	10	212
C3140IP	7314150391158	340	10	10	212
C3230	7314150393329	340	10	10	215
C3230IP	7314150391189	340	10	10	215
C3330	7314150393336	340	10	10	212
C3330IP	7314150391196	340	10	10	212
C3330R	7314150393343	340	10	10	212
C3330R IP	7314150391202	340	10	10	212
C3340R	7314150393350	340	10	10	212
C3340R IP	7314150391219	340	10	10	212
C3430	7314150393367	340	10	10	223
C3430IP	7314150391226	340	10	10	223
C3530	7314150393374	340	10	10	224
C3530IP	7314150391233	340	10	10	224
C3630	7314150393381	340	10	10	220
C3630IP	7314150391240	340	10	10	220
C3640	7314150393398	340	10	10	220
C3640IP	7314150391257	340	10	10	220
C3745	7314150393404	340	10	10	221
C3745IP	7314150391264	340	10	10	221
C3790	7314150393411	340	10	10	221
C3790IP	7314150391271	340	10	10	221
C3830	7314150393428	340	10	10	220
C3830IP	7314150391288	340	10	10	220
C3840	7314150393435	340	10	10	220
C3840IP	7314150391295	340	10	10	220
C3901/3	7314150392797	340	10	1	235
C3902/3	7314150399604	340	10	1	235
CFP250	7314150400669	358	20	6	550
CFW250	7314150400683	358	20	6	550
CHALK-BLUE	7314150128686	336	10	6	486
CHALK-RED	7314150128709	336	10	6	486
CHALK-WHITE	7314150179671	336	10	6	486
CHALK-YELLOW	7314150128693	336	10	6	486
CL-1221	7314150127122	336	10	6	486
CL-1221-SET	7314150188574	336	10	4	486
CL-1331	7314150347728	336	10	48	486
CL-1331-SET	7314150360741	336	10	16	486
CL-1441	7314150347735	336	10	36	486
CL-1441-SET	7314150360758	336	10	16	486
CLIPS-1/2	7314153003201	354	15	25	88
CLIPS-1/4	7314153003188	354	15	25	67
CLIPS-3/8	7314153003195	354	15	25	79
CR B 01	7314150215409	340	40	5	231
CR B 02	7314150215416	340	40	5	232
CR B 03	7314150215423	340	40	5	232
CR B 05	7314150215454	340	40	2	232
CR B 06	7314150215461	340	40	2	232
CR HL 01	7314150215850	340	40	1	233
CR HL 02	7314150215867	340	40	1	234
CR HL 03	7314150215874	340	40	1	234
CR HL 04	7314150215881	340	40	1	234
CR HL 05	7314150215898				



CR W 04	7314150215522	340	40	1	233
CR W 05	7314150215539	340	40	1	233
CR W 06	7314150215546	340	40	1	233
CR W 07	7314150215553	340	40	1	233
CS150	7314150125241	336	10	12	488
CS300	7314150125258	336	10	12	488
CS400	7314150125265	336	10	12	488
CUC-0.4-360	7314150342075	326	15	4	538
CUC-0.8-600	7314150342099	326	15	4	538
D-DD/S20	7311518280345	354	30	4	107
D/S10	7311518280307	354	30	6	107
D/S14	7311518280314	354	30	6	106
D0303C03	7311518100964	346	15	1	144
D0303F03	7311518100940	346	15	1	144
D0303M03	7311518100957	346	15	1	144
D0303M03X	7311518182052	346	15	1	144
D0605M03X	7311518197896	346	15	1	144
D0606C06	7311518043872	346	15	1	144
D0606F06	7311518100971	346	15	1	144
D0606M06	7311518100988	346	15	1	144
D0606M06X	7311518101008	346	15	1	144
D0807C06	7311518043933	346	15	1	144
D0807F06	7311518043889	346	15	1	144
D0807M06	7311518043896	346	15	1	144
D0807M06X	7311518043919	346	15	1	144
D1009C06	7311518035310	346	15	1	144
D1009F06	7311518043926	346	15	1	144
D1009M06	7311518035280	346	15	1	144
D1009M06X	7311518035297	346	15	1	144
D1211AL06	7311518187644	346	15	1	143
D1211AL08	7311518181840	346	15	1	143
D1211C06	7311518035365	346	15	1	144
D1211F06	7311518035327	346	15	1	144
D1211F06D	7311518266424	346	15	1	144
D1211M06	7311518035334	346	15	1	144
D1211M06X	7311518035358	346	15	1	144
D1614C06	7311518192341	346	15	1	144
D1614C08	7311518035419	346	15	1	144
D1614F06	7311518192334	346	15	1	144
D1614F08	7311518035372	346	15	1	144
D1614M06	7311518192327	346	15	1	144
D1614M06X	7311518187385	346	15	1	144
D1614M08	7311518035389	346	15	1	144
D1614M08X	7311518035402	346	15	1	144
DD/S10	7311518280321	354	30	6	107
DD/S14	7311518280338	354	30	4	106
DOW 175-1	7314152202728	338	10	1	244
DOW 175-11/2	7314152202995	338	10	1	244
DOW 175-2	7314152203022	338	10	1	244
DOW 175-3	7314152203299	338	10	1	244
DOW 176-1	7314152206047	338	10	1	245
DOW 176-11/2	7314152206122	338	10	1	245
DOW 176-2	7314152206399	338	10	1	245
DOW 177-1/2-1	7314152816383	338	10	1	244
DOW 177-11/2	7314152816468	338	10	1	244
DOW 177-2	7314152816543	338	10	1	244
E0308C03	7311518035440	346	15	1	145
E0308F03	7311518035426	346	15	1	145
E0308M03	7311518035433	346	15	1	145
E0308M03X	7311518192372	346	15	1	145
E0614C06	7311518035495	346	15	1	145
E0614F06	7311518035457	346	15	1	145
E0614M06	7311518035464	346	15	1	145
E0816C06	7311518035549	346	15	1	145
E0816F06	7311518035501	346	15	1	145
E0816M06	7311518035518	346	15	1	145
E0816M06X	7311518035532	346	15	1	145
E1018C06	7311518035594	346	15	1	145
E1018F06	7311518035556	346	15	1	145
E1018M06	7311518035563	346	15	1	145
E1018M06X	7311518035587	346	15	1	145
E1222C06	7311518035648	346	15	1	145
E1222C08	7311518035686	346	15	1	145
E1222F06	7311518035600	346	15	1	145
E1222F08	7311518035655	346	15	1	145
E1222M06	7311518035617	346	15	1	145
E1222M06X	7311518035631	346	15	1	145
E1222M08	7311518172558	346	15	1	145
E1222M08X	7311518199302	346	15	1	145
E1625C06	7311518192464	346	15	1	145
E1625C08	7311518035730	346	15	1	145
E1625F06	7311518192457	346	15	1	145
E1625F08	7311518035693	346	15	1	145
E1625M06	7311518192440	346	15	1	145
E1625M06X	7311518187392	346	15	1	145
E1625M08	7311518035709	346	15	1	145
E1625M08X	7311518035723	346	15	1	145
EX-14-TEN-C	7311518298333	330	10	10	504
EX-14-VEN-C	7311518298340	330	10	10	505
EX-16-GNP-C	7311518298685	330	10	10	502
EX-19-XT9-C	7311518298302	330	10	10	503
EX-20-LAM-C	7311518298326	330	10	10	504
EX-20-XT11-C	7311518298319	330	10	10	504
EX-22-PLS-C	7311518298357	330	10	10	502
EX-22-U7	7311518300890	330	10	10	503
EX-22-XT7-C	7311518298289	330	10	10	505
EX-22-XT9-C	7311518298296	330	10	10	503
EX-24-XT7-C	7311518298272	330	10	10	505



EX-244P-22	7311518298456	330	10	10	506
EX-LL	7311518298494	330	10	4	506
EX-NPP-22	7311518324162	330	10	10	503
EX-RL	7311518298487	330	10	4	506
EX-RM	7311518298470	330	10	4	506
F0313C03	7311518035761	346	15	1	145
F0313F03	7311518035747	346	15	1	145
F0313M03	7311518035754	346	15	1	145
F0313M03X	7311518192495	346	15	1	145
F0612C04	7311518192525	346	15	1	145
F0612F04	7311518192518	346	15	1	145
F0612M04	7311518035778	346	15	1	145
F0612M04X	7311518188474	346	15	1	145
F0613M03X	7311518196608	346	15	1	145
F0618AL06	7311518181857	346	15	1	144
F0618C06	7311518035822	346	15	1	145
F0618F06	7311518035785	346	15	1	145
F0618M06	7311518035792	346	15	1	145
F0618M06X	7311518035815	346	15	1	145
F0820C06	7311518035877	346	15	1	145
F0820F06	7311518035846	346	15	1	145
F0820M06	7311518035839	346	15	1	145
F0820M06X	7311518035860	346	15	1	145
F1020C06	7311518035921	346	15	1	145
F1020F06	7311518035884	346	15	1	145
F1020M06	7311518035891	346	15	1	145
F1020M06X	7311518035914	346	15	1	145
F1225AL06	7311518187651	346	15	1	144
F1225AL08	7311518181864	346	15	1	144
F1225C06	7311518035969	346	15	1	145
F1225C08	7311518036010	346	15	1	145
F1225F06	7311518035938	346	15	1	145
F1225F08	7311518035976	346	15	1	145
F1225M06	7311518035945	346	15	1	145
F1225M06X	7311518036003	346	15	1	145
F1225M08	7311518035983	346	15	1	145
F1225M08X	7311518192563	346	15	1	145
F1625C06	7311518192594	346	15	1	145
F1625C08	7311518036065	346	15	1	145
F1625F06	7311518192587	346	15	1	145
F1625F08	7311518036027	346	15	1	145
F1625M06	7311518192570	346	15	1	145
F1625M06X	7311518187408	346	15	1	145
F1625M08	7311518036034	346	15	1	145
F1625M08X	7311518036058	346	15	1	145
FCP-1.8-810	7311518123970	326	15	4	538
FCP-2.3-860	7311518123994	326	15	2	538
FCS-1000	7314150321551	336	10	6	488
FCS-600	7314150321537	336	10	6	488
FCS-800	7314150321544	336	10	6	488
FF1A01	7314150228560	356	25	1	367
FF1A02	7314150228591	356	25	1	367
FF1A03	7314150228607	356	25	1	367
FF1A04	7314150227778	356	25	1	367
FF1A05	7314150227808	356	25	1	367
FF1A06	7314150227822	356	25	1	368
FF1A07	7314150227846	356	25	1	368
FF1A08	7314150227976	356	25	1	368
FF1A09	7314150227990	356	25	1	368
FF1A10	7314150228010	356	25	1	368
FF1A1001	7314150286478	356	25	1	369
FF1A1002	7314150286461	356	25	1	369
FF1A1003	7314150286485	356	25	1	369
FF1A1004	7314150286454	356	25	1	369
FF1A1005	7314150286591	356	25	1	369
FF1A1006	7314150286645	356	25	1	370
FF1A1007	7314150286621	356	25	1	370
FF1A1008	7314150309443	356	25	1	370
FF1A1010	7314150320660	356	25	1	370
FF1A1011	7314150339068	356	25	1	370
FF1A102	7314150334841	356	40	1	370
FF1A104	7314150334865	356	40	1	370
FF1A106	7314150335541	356	40	1	371
FF1A11	7314150228034	356	25	1	371
FF1A110	7314150335619	356	40	1	371
FF1A112	7314150335572	356	40	1	371
FF1A114	7314150335633	356	40	1	371
FF1A115	7314150335640	356	40	1	371
FF1A117	7314150335701	356	40	1	372
FF1A118	7314150335732	356	40	1	372
FF1A119	7314150335749	356	40	1	372
FF1A12	7314150228058	356	25	1	372
FF1A121	7314150335718	356	40	1	372
FF1A124	7314150335725	356	40	1	372
FF1A127	7314150336395	356	40	1	373
FF1A128	7314150336586	356	40	1	373
FF1A129	7314150336593	356	40	1	373
FF1A13	7314150228072	356	25	1	373
FF1A130	7314150336661	356	40	1	373
FF1A131	7314150336678	356	40	1	374
FF1A132	7314150336685	356	40	1	374
FF1A133	7314150336692	356	40	1	374
FF1A134	7314150336708				



CUENTA SUBGRUPO



FF1A14	7314150228089	356	25	1	375
FF1A141	7314150336777	356	40	1	375
FF1A142	7314150338573	356	40	1	376
FF1A143	7314150338580	356	40	1	376
FF1A145	7314150338603	356	40	1	376
FF1A146	7314150338610	356	40	1	376
FF1A147	7314150338627	356	40	1	376
FF1A15	7314150228096	356	25	1	377
FF1A16	7314150228102	356	25	1	377
FF1A17	7314150228119	356	25	1	377
FF1A18	7314150228126	356	25	1	377
FF1A19	7314150254354	356	25	1	377
FF1A20	7314150254361	356	25	1	377
FF1A21	7314150254378	356	25	1	378
FF1A22	7314150254385	356	25	1	378
FF1A23	7314150254392	356	25	1	378
FF1A2301	7314150286508	356	25	1	378
FF1A24	7314150254408	356	25	1	378
FF1A25	7314150254415	356	25	1	379
FF1A2501	7314150286492	356	25	1	379
FF1A2503	7314150320677	356	25	1	379
FF1A26	7314150254422	356	25	1	380
FF1A27	7314150254439	356	25	1	380
FF1A28	7314150254446	356	25	1	380
FF1A3001	7314150286515	356	25	1	380
FF1A3002	7314150289264	356	25	1	380
FF1A3003	7314150286522	356	25	1	380
FF1A3004	7314150286676	356	25	1	381
FF1A3005	7314150286638	356	25	1	381
FF1A35	7314150264124	356	25	1	381
FF1A36	7314150265862	356	25	1	381
FF1A37	7314150265855	356	25	1	381
FF1A39	7314150266920	356	25	1	381
FF1A40	7314150266951	356	25	1	382
FF1A4001	7314150286713	356	25	1	382
FF1A4002	7314150286560	356	25	1	382
FF1A4003	7314150286706	356	25	1	382
FF1A41	7314150266982	356	25	1	382
FF1A49	7314150271818	356	40	1	382
FF1A50	7314150271825	356	40	1	383
FF1A5001	7314150286430	356	25	1	383
FF1A5002	7314150286447	356	25	1	383
FF1A5003	7314150286690	356	25	1	383
FF1A5004	7314150286539	356	25	1	383
FF1A5005	7314150286546	356	25	1	384
FF1A5006	7314150286683	356	25	1	384
FF1A5007	7314150286553	356	25	1	384
FF1A5008	7314150286607	356	25	1	384
FF1A5009	7314150286669	356	25	1	385
FF1A5010	7314150286584	356	25	1	385
FF1A5011	7314150286614	356	25	1	385
FF1A5012	7314150286652	356	25	1	385
FF1A5013	7314150286577	356	25	1	385
FF1A5015	7314150307401	356	25	1	385
FF1A5017	7314150307425	356	25	1	386
FF1A5019	7314150309436	356	25	1	386
FF1A5021	7314150309467	356	25	1	386
FF1A5022	7314150309474	356	25	1	386
FF1A5023	7314150309498	356	25	1	386
FF1A5024	7314150309504	356	25	1	386
FF1A5027	7314150320684	356	25	1	387
FF1A5028	7314150320691	356	25	1	387
FF1A5029	7314150320707	356	25	1	387
FF1A5030	7314150320714	356	25	1	387
FF1A5031	7314150320721	356	25	1	387
FF1A5032	7314150320738	356	25	1	388
FF1A5036	7314150339037	356	25	1	388
FF1A5037	7314150339044	356	25	1	388
FF1A5038	7314150339051	356	25	1	388
FF1A51	7314150271832	356	40	1	388
FF1A53	7314150271856	356	40	1	388
FF1A54	7314150288786	356	40	1	366
FF1A55	7314150299720	356	40	1	389
FF1A56	7314150299737	356	40	1	389
FF1A59	7314150306442	356	40	1	389
FF1A65	7314150313389	356	40	1	389
FF1A66	7314150313396	356	40	1	389
FF1A67	7314150313402	356	40	1	389
FF1A68	7314150313419	356	40	1	390
FF1A70	7314150320189	356	40	1	390
FF1A71	7314150320196	356	40	1	390
FF1A72	7314150320202	356	40	1	390
FF1ASET-AUTO3	7314150254477	356	25	1	411
FF1ASET-AUTO6	7314150319909	356	25	1	410
FF1ASET-MAX	7314150255306	356	25	1	403
FF1ASET-MRO2	7314150336623	356	40	1	410
FF1ASET-MRO3	7314150336630	356	40	1	410
FF1ASET-MRO4	7314150336647	356	40	1	410
FF1ASET-MRO5	7314150336654	356	40	1	410
FF1E1001	7314150285839	356	25	1	352
FF1E1002	7314150285761	356	25	1	352
FF1E1003	7314150285853	356	25	1	352
FF1E1004	7314150285754	356	25	1	352
FF1E1005	7314150285785	356	25	1	352
FF1E1006	7314150285778	356	25	1	352
FF1E1007	7314150285792	356	25	1	353
FF1E1008	7314150285822	356	25	1	353
FF1E1009	7314150285808	356	25	1	353



CUENTA SUBGRUPO



FF1E1010	7314150285815	356	25	1	353
FF1E1011	7314150285846	356	25	1	353
FF1E2001	7314150285945	356	25	1	353
FF1E2002	7314150285921	356	25	1	353
FF1E2003	7314150286072	356	25	1	354
FF1E2004	7314150285952	356	25	1	354
FF1E2005	7314150285976	356	25	1	354
FF1E2006	7314150285914	356	25	1	354
FF1E2007	7314150285907	356	25	1	354
FF1E2008	7314150285860	356	25	1	354
FF1E2101	7314150285877	356	25	1	355
FF1E2102	7314150286058	356	25	1	355
FF1E2103	7314150286089	356	25	1	355
FF1E2104	7314150285990	356	25	1	355
FF1E2105	7314150286041	356	25	1	355
FF1E2201	7314150286010	356	25	1	355
FF1E2202	7314150285891	356	25	1	356
FF1E2203	7314150285884	356	25	1	356
FF1E2204	7314150285983	356	25	1	356
FF1E2205	7314150285938	356	25	1	356
FF1E2206	7314150286034	356	25	1	356
FF1E2207	7314150285969	356	25	1	356
FF1E2208	7314150286027	356	25	1	357
FF1E2209	7314150286096	356	25	1	357
FF1E2210	7314150286065	356	25	1	357
FF1E2211	7314150339006	356	25	1	357
FF1E2212	7314150339013	356	25	1	357
FF1E2213	7314150339020	356	25	1	357
FF1E2501	7314150286003	356	25	1	358
FF1E2502	7314150338993	356	25	1	358
FF1E3001	7314150286119	356	25	1	358
FF1E3002	7314150286102	356	25	1	358
FF1E3003	7314150286157	356	25	1	358
FF1E3004	7314150286133	356	25	1	358
FF1E3005	7314150286126	356	25	1	358
FF1E3006	7314150286140	356	25	1	358
FF1E3007	7314150286164	356	25	1	359
FF1E3008	7314150286171	356	25	1	359
FF1E4001	7314150285747	356	25	1	359
FF1E4002	7314150285730	356	25	1	359
FF1E5001	7314150285716	356	25	1	359
FF1E5002	7314150285709	356	25	1	359
FF1E5003	7314150285723	356	25	1	359
FF1E5004	7314150338931	356	25	1	359
FF1E5005	7314150338948	356	25	1	360
FF1E5006	7314150338955	356	25	1	360
FF1E5007	7314150338962	356	25	1	360
FF1E5008	7314150338979	356	25	1	360
FF1E5009	7314150338986	356	25	1	360
FF1F1001	7314150286270	356	25	1	360
FF1F1002	7314150286287	356	25	1	360
FF1F1003	7314150286294	356	25	1	360
FF1F1004	7314150286263	356	25	1	361
FF1F1005	7314150286300	356	25	1	361
FF1F1006	7314150286249	356	25	1	361
FF1F1007	7314150286256	356	25	1	361
FF1F1008	7314150339129	356	25	1	361
FF1F1009	7314150339136	356	25	1	361
FF1F2001	7314150286317	356	25	1	361
FF1F2002	7314150339143	356	25	1	362
FF1F2101	7314150286331	356	25	1	362
FF1F2102	7314150339105	356	25	1	362
FF1F2103	7314150339112	356	25	1	362
FF1F2201	7314150286324	356	25	1	362
FF1F2202	7314150339150	356	25	1	362
FF1F2203	7314150339167	356	25	1	362
FF1F3001	7314150286348	356	25	1	363
FF1F3002	7314150286379	356	25	1	363
FF1F3003	7314150286409	356	25	1	363
FF1F3004	7314150286386	356	25	1	363
FF1F3005	7314150286362	356	25	1	363
FF1F3006	7314150286355	356	25	1	363
FF1F3007	7314150286393	356	25	1	363
FF1F3008	7314150286423	356	25	1	364
FF1F3009	7314150286416	356	25	1	364
FF1F3010	7314150339082	356	25	1	364
FF1F3011	7314150339099	356	25	1	364
FF1F4001	7314150286195	356	25	1	364
FF1F4002	7314150286201	356	25	1	364
FF1F4003	7314150286225	356	25	1	364
FF1F4004	7314150286232	356	25	1	364
FF1F4005	7314150286218	356	25	1	365
FF1F5001	7314150286188	356	25	1	365
FF1F5002	7314150339174	356	25	1	365
FF1F5003	7314150339181	356	25	1	365
FF1F5004	7314150339198	356	25	1	365
FF1F5005	7314150339204	356	25	1	365
FF1F5006	7314150339211	356	25	1	365
FF1F5007	7314150339228	356	25	1	366
FF1F5008	7314150339235	356	25	1	366</

K1612M06



CUENTA SUBGRUPO



K1612M06	7311518193959	346	15	1	146
K1612M08	7311518036768	346	15	1	146
K172	7314150384396	354	35	1	104
K18NF-2	7314151347161	346	50	5	166
K18PH-2M5	7314153019646	346	50	5	166
K18PH-2M6	7314150274871	346	50	5	166
K19PZD-2M5	7314151693237	346	50	1	166
K19PZD-2NF	7314151586157	346	50	1	166
K20TORX-T25	7314151825799	346	50	10	166
K560F-1	7314151825492	354	35	5	102
K560F-2	7314151825324	354	35	5	104
K560F-3	7314151825331	354	35	5	104
K560F-4	7314151825348	354	35	5	106
K560F-5	7314151825355	354	35	5	106
K560F-6	7314151825362	354	35	5	108
K560F-7	7314151825379	354	35	5	110
K560F-8	7314151825508	354	35	5	110
K560F-9	7314151846688	354	35	5	112
K66100-1/4	7314150204540	346	52	1	157
K66100-1/4-1P	7314150260201	346	52	25	157
K66100-3/8	7314150204564	346	52	1	157
K66100-3/8-1P	7314150260249	346	52	25	157
K6625-1/4	7314150204496	346	52	1	157
K6625-1/4-1P	7314150260140	346	52	1	157
K6638-3/8	7314150204557	346	52	1	157
K6638-3/8-1P	7314150260164	346	52	25	157
K6650-1/2	7314150204519	346	52	1	157
K6650-1/2-1P	7314150260188	346	52	1	157
K6650-1/4	7314150204526	346	52	1	157
K6650-1/4-1P	7314150204533	346	52	1	157
K6650-3/8	7314150204502	346	52	1	157
K6650-3/8-1P	7314150260225	346	52	1	157
K6660-QR-1P	7314150204571	346	52	1	157
K6701M-10	7314151778149	354	30	1	102
K6701M-11	7314151778224	354	30	1	102
K6701M-12	7314151811891	354	30	1	102
K6701M-13	7314151778491	354	30	1	102
K6701M-14	7314151844172	354	30	1	102
K6701M-6	7314151813260	354	30	1	102
K6701M-7	7314151777920	354	30	1	102
K6701M-8	7314151778064	354	30	1	102
K6701M-9	7314151815110	354	30	1	102
K6750-1/4	7314150204663	346	48	1	159
K6750-10	7314150204700	346	48	1	159
K6750-13	7314150204823	346	48	1	159
K6750-3/8	7314150204656	346	48	1	159
K6750-6	7314150204670	346	48	1	159
K6750-7	7314150204687	346	48	1	159
K6750-8	7314150204694	346	48	1	159
K6964C	7314151215170	354	35	1	103
K7401M-10	7314151780128	354	30	1	103
K7401M-11	7314151780395	354	30	1	103
K7401M-12	7314151811907	354	30	1	103
K7401M-13	7314151780470	354	30	1	103
K7401M-14	7314151780555	354	30	1	103
K7401M-15	7314151812140	354	30	1	103
K7401M-16	7314151780630	354	30	1	103
K7401M-17	7314151780715	354	30	1	103
K7401M-18	7314151812157	354	30	1	103
K7401M-19	7314151812164	354	30	1	103
K7401M-20	7314151844271	354	30	1	103
K7401M-21	7314151845216	354	30	1	103
K7401M-22	7314151845223	354	30	1	103
K7401M-24	7314151844295	354	30	1	103
K7401M-7	7314151812126	354	30	1	103
K7401M-8	7314151780043	354	30	1	103
K7401M-9	7314151812133	354	30	1	103
K7401TORX-E-S7	7314150343324	354	30	1	104
K7401TORX-E10	7314151844448	354	30	1	103
K7401TORX-E12	7314151844455	354	30	1	103
K7401TORX-E14	7314151844462	354	30	1	103
K7401TORX-E5	7314151844400	354	30	1	103
K7401TORX-E6	7314151844417	354	30	1	103
K7401TORX-E7	7314151844424	354	30	1	103
K7401TORX-E8	7314151844431	354	30	1	103
K7401Z-1/2	7314150384402	354	30	1	103
K7401Z-11/16	7314150384419	354	30	1	103
K7401Z-13/16	7314150384426	354	30	1	103
K7401Z-3/4	7314150384433	354	30	1	103
K7401Z-3/8	7314150384440	354	30	1	103
K7401Z-5/8	7314150384457	354	30	1	103
K7401Z-7/16	7314150384464	354	30	1	103
K7401Z-7/8	7314150384471	354	30	1	103
K7401Z-9/16	7314150384488	354	30	1	103
K7406M-10	7314151844479	354	30	1	103
K7406M-13	7314151844486	354	30	1	103
K7406M-17	7314151844493	354	30	1	103
K7760C-1	7314151222369	354	35	1	103
K7760C-2	7314151222376	354	35	1	103
K7764D	7314151222475	354	35	1	105
K7767S	7314151222512	354	35	1	103
K7800M-10	7314150326297	354	30	1	104
K7800M-11	7314150326303	354	30	1	104
K7800M-12	7314150326310	354	30	1	104
K7800M-13	7314150326327	354	30	1	104
K7800M-14	7314150326334	354	30	1	104
K7800M-15	7314150326341	354	30	1	104
K7800M-16	7314150326358	354	30	1	104



CUENTA SUBGRUPO



K7800M-17	7314150326365	354	30	1	104
K7800M-18	7314150326372	354	30	1	104
K7800M-19	7314150326389	354	30	1	104
K7800M-21	7314150326396	354	30	1	104
K7800M-22	7314150326402	354	30	1	104
K7800M-24	7314150326419	354	30	1	104
K7801M-10	7314151778576	354	30	1	104
K7801M-11	7314151778651	354	30	1	104
K7801M-12	7314151815790	354	30	1	104
K7801M-13	7314151778736	354	30	1	104
K7801M-14	7314151778811	354	30	1	104
K7801M-15	7314151815806	354	30	1	104
K7801M-16	7314151779030	354	30	1	104
K7801M-17	7314151779115	354	30	1	104
K7801M-18	7314151779382	354	30	1	104
K7801M-19	7314151779467	354	30	1	104
K7801M-20	7314151844509	354	30	1	104
K7801M-21	7314151779542	354	30	1	104
K7801M-22	7314151779627	354	30	1	104
K7801M-23	7314151844516	354	30	1	104
K7801M-24	7314151779894	354	30	1	104
K7801M-25	7314151844523	354	30	1	104
K7801M-26	7314151844530	354	30	1	104
K7801M-27	7314151779979	354	30	1	104
K7801M-30	7314151811914	354	30	1	104
K7801M-32	7314151825157	354	30	1	104
K7801M-34	7314151844547	354	30	1	104
K7801M-36	7314151844554	354	30	1	104
K7801M-8	7314151845230	354	30	1	104
K7801M-9	7314151845247	354	30	1	104
K7801TORX-E10	7314151811587	354	30	1	105
K7801TORX-E12	7314151811594	354	30	1	105
K7801TORX-E14	7314151811600	354	30	1	105
K7801TORX-E16	7314151811617	354	30	1	105
K7801TORX-E18	7314151811624	354	30	1	105
K7801TORX-E20	7314151811631	354	30	1	105
K7801TORX-E24	7314151811648	354	30	1	105
K7801VM-17	7314151781521	354	30	1	104
K7801VM-19	7314151781798	354	30	1	104
K7801VM-22	7314151781873	354	30	1	104
K7801VM-24	7314151781958	354	30	1	104
K7801VM/S4	7314151799090	354	30	1	106
K7801Z-1	7314151844639	354	30	1	105
K7801Z-1.1/16	7314151844646	354	30	1	105
K7801Z-1.1/2	7314150137701	354	30	5	105
K7801Z-1.1/4	7314151844660	354	30	1	105
K7801Z-1.1/8	7314151844653	354	30	1	105
K7801Z-1.3/8	7314150137688	354	30	5	105
K7801Z-1.5/16	7314150137671	354	30	5	105
K7801Z-1.7/16	7314150137695	354	30	5	105
K7801Z-1/2	7314151822620	354	30	1	105
K7801Z-11/16	7314151844592	354	30	1	105
K7801Z-13/16	7314151844608	354	30	1	105
K7801Z-15/16	7314151844622	354	30	1	105
K7801Z-3/4	7314151822668	354	30	1	105
K7801Z-3/8	7314151822606	354	30	1	105
K7801Z-5/8	7314151844585	354	30	1	105
K7801Z-7/16	7314151844561	354	30	1	105
K7801Z-7/8	7314151844615	354	30	1	105
K7801Z-9/16	7314151822637	354	30	1	105
K7801Z/10	7314150165018	354	30	1	107
K7806M-10	7314151844677	354	30	1	105
K7806M-11	7314151844684	354	30	1	105
K7806M-12	7314151844691	354	30	1	105
K7806M-13	7314151805944	354	30	1	105
K7806M-14	7314151844707	354	30	1	105
K7806M-15	7314150330683	354	30	1	105
K7806M-16	7314151844714	354	30	1	105
K7806M-17	7314151805951	354	30	1	105
K7806M-18	7314151844721	354	30	1	105
K7806M-19	7314151805968	354	30	1	105
K7806M-21	7314151823597	354	30	1	105
K7806M-22	7314151805975	354	30	1	105
K7806M-23	7314151844738	354	30	1	105
K7806M-24	7314151805982	354	30	1	105
K7806M-27	7314151805999	354	30	1	105
K7806M-30	7314151844578	354	30	1	105
K7806M-32	7314150220304	354	30	1	105
K7806M-36	7314150220311	354	30	1	105
K7806M/S4	7314151813222	354	30	1	106
K7806Z-1	7314150137817	354	30	5	105
K7806Z-1.1/16	7314150137824	354	30	5	105
K7806Z-1.1/2	7314150137886	354	30	5	105
K7806Z-1.1/4	7314150137848	354	30	5	105
K7806Z-1.1/8					



CUENTA SUBGRUPO



K7806Z/10	7314150165025	354	30	1	107
K8160D-1	7314151237400	354	35	1	105
K8160D-2	7314151237417	354	35	1	105
K8160D-3	7314151237424	354	35	1	105
K8164C	7314151237523	354	35	1	103
K8164F	7314151237554	354	35	1	108
K8167S	7314151237592	354	35	1	105
K8901M-17	7314151803155	354	30	1	107
K8901M-18	7314151844189	354	30	1	107
K8901M-19	7314151803162	354	30	1	107
K8901M-21	7314151803179	354	30	1	107
K8901M-22	7314151803186	354	30	1	107
K8901M-23	7314151803193	354	30	1	107
K8901M-24	7314151803209	354	30	1	107
K8901M-27	7314151803216	354	30	1	107
K8901M-28	7314151803223	354	30	1	107
K8901M-29	7314151803230	354	30	1	107
K8901M-30	7314151803247	354	30	1	107
K8901M-32	7314151803254	354	30	1	107
K8901M-33	7314151803261	354	30	1	107
K8901M-34	7314151803278	354	30	1	107
K8901M-36	7314151803285	354	30	1	107
K8901M-38	7314151803292	354	30	1	107
K8901M-41	7314151803308	354	30	1	107
K8901M-46	7314151803315	354	30	1	107
K8901M-50	7314151846398	354	30	1	107
K8901M-55	7314151846404	354	30	1	107
K8901M-60	7314151846411	354	30	1	107
K8901M/8	7314150165032	354	30	1	109
K8901Z-1	7314151844752	354	30	1	108
K8901Z-1.1/16	7314151844769	354	30	1	108
K8901Z-1.1/2	7314151844820	354	30	1	108
K8901Z-1.1/4	7314151844783	354	30	1	108
K8901Z-1.1/8	7314151844776	354	30	1	108
K8901Z-1.11/16	7314150130269	354	30	1	108
K8901Z-1.13/16	7314150130276	354	30	1	108
K8901Z-1.15/16	7314150130290	354	30	1	108
K8901Z-1.3/16	7314150130245	354	30	1	108
K8901Z-1.3/4	7314151844844	354	30	1	108
K8901Z-1.3/8	7314151844806	354	30	1	108
K8901Z-1.5/16	7314151844790	354	30	1	108
K8901Z-1.5/8	7314151844837	354	30	1	108
K8901Z-1.7/16	7314151844813	354	30	1	108
K8901Z-1.7/8	7314150130283	354	30	1	108
K8901Z-1.9/16	7314150130252	354	30	1	108
K8901Z-11/16	7314150130238	354	30	1	108
K8901Z-13/16	7314151844226	354	30	1	108
K8901Z-15/16	7314151844745	354	30	1	108
K8901Z-2	7314150130306	354	30	1	108
K8901Z-2.1/16	7314150130313	354	30	1	108
K8901Z-2.1/4	7314150130344	354	30	1	108
K8901Z-2.3/16	7314150130337	354	30	1	108
K8901Z-2.3/8	7314150130351	354	30	1	108
K8901Z-3/4	7314151844202	354	30	1	108
K8901Z-7/8	7314151844301	354	30	1	108
K8901Z/8	7314150165049	354	30	1	109
K8906M-17	7314151803056	354	30	1	108
K8906M-19	7314151803063	354	30	1	108
K8906M-21	7314151844851	354	30	1	108
K8906M-22	7314151803070	354	30	1	108
K8906M-24	7314151803087	354	30	1	108
K8906M-27	7314151803094	354	30	1	108
K8906M-30	7314151803117	354	30	1	108
K8906M-32	7314151803124	354	30	1	108
K8906M-33	7314151844868	354	30	1	108
K8906M-34	7314151844875	354	30	1	108
K8906M-36	7314151803148	354	30	1	108
K8906M-41	7314151845254	354	30	1	108
K8906M-46	7314150220601	354	30	1	108
K8906M/8	7314150165056	354	30	1	109
K8906Z-1	7314150130436	354	30	1	108
K8906Z-1.1/16	7314150130443	354	30	1	108
K8906Z-1.1/2	7314150130511	354	30	1	108
K8906Z-1.1/4	7314150130474	354	30	1	108
K8906Z-1.1/8	7314150130450	354	30	1	108
K8906Z-1.3/4	7314150130559	354	30	1	108
K8906Z-1.3/8	7314150130498	354	30	1	108
K8906Z-1.5/16	7314150130481	354	30	1	108
K8906Z-1.5/8	7314150130535	354	30	1	108
K8906Z-1.7/16	7314150130504	354	30	1	108
K8906Z-13/16	7314150130405	354	30	1	108
K8906Z-15/16	7314150130429	354	30	1	108
K8906Z-2	7314150130580	354	30	1	108
K8906Z-3/4	7314150130399	354	30	1	108
K8906Z-7/8	7314150130412	354	30	1	108
K8906Z/8	7314150165063	354	30	1	109
K8909H-5	7314151619343	354	35	1	108
K8909ML-12	7314151232863	354	30	1	110
K8909ML-14	7314151232870	354	30	1	110
K8909ML-17	7314151232887	354	30	1	110
K8960F-2	7314151268138	354	35	1	108
K8960F-3	7314151268145	354	35	1	108
K8960F-4	7314150220625	354	30	10	108
K8964D	7314151268237	354	35	1	105
K8964G	7314151268268	354	35	1	110
K8967S	7314151268329	354	35	1	108
K9501M-22	7314151844882	354	30	1	109
K9501M-24	7314151802677	354	30	1	109



CUENTA SUBGRUPO



K9501M-27	7314151802684	354	30	1	109
K9501M-30	7314151802714	354	30	1	109
K9501M-32	7314151802721	354	30	1	109
K9501M-33	7314151802738	354	30	1	109
K9501M-34	7314151802745	354	30	1	109
K9501M-36	7314151802752	354	30	1	109
K9501M-38	7314151802769	354	30	1	109
K9501M-41	7314151802776	354	30	1	109
K9501M-42	7314151802783	354	30	1	109
K9501M-46	7314151802790	354	30	1	109
K9501M-50	7314151802806	354	30	1	109
K9501M-55	7314151802813	354	30	1	109
K9501M-60	7314151802820	354	30	1	109
K9501M-65	7314151802837	354	30	1	109
K9501M-70	7314151802844	354	30	1	109
K9501M-75	7314151802851	354	30	1	109
K9501M-80	7314151802868	354	30	1	109
K9501M-85	7314150352197	354	30	1	109
K9501Z-1	7314151844912	354	30	1	109
K9501Z-1.1/16	7314150130634	354	30	1	109
K9501Z-1.1/2	7314151844943	354	30	1	109
K9501Z-1.1/4	7314151844929	354	30	1	109
K9501Z-1.1/8	7314150130641	354	30	1	109
K9501Z-1.11/16	7314150130696	354	30	1	109
K9501Z-1.13/16	7314151844967	354	30	1	109
K9501Z-1.15/16	7314150130719	354	30	1	109
K9501Z-1.3/16	7314150130658	354	30	1	109
K9501Z-1.3/4	7314150130702	354	30	1	109
K9501Z-1.3/8	7314150130672	354	30	1	109
K9501Z-1.5/16	7314150130665	354	30	1	109
K9501Z-1.5/8	7314151844950	354	30	1	109
K9501Z-1.7/16	7314151844936	354	30	1	109
K9501Z-1.7/8	7314151844974	354	30	1	109
K9501Z-1.9/16	7314150130689	354	30	1	109
K9501Z-2	7314150130726	354	30	1	109
K9501Z-2.1/4	7314150130764	354	30	1	109
K9501Z-2.1/8	7314150130740	354	30	1	109
K9501Z-2.3/16	7314150130757	354	30	1	109
K9501Z-2.3/4	7314150130832	354	30	1	109
K9501Z-2.5/16	7314150130771	354	30	1	109
K9501Z-2.9/16	7314150130801	354	30	1	109
K9506M-22	7314151844998	354	30	1	110
K9506M-24	7314151802530	354	30	1	110
K9506M-27	7314151802547	354	30	1	110
K9506M-30	7314151802554	354	30	1	110
K9506M-32	7314151802561	354	30	1	110
K9506M-33	7314151802578	354	30	1	110
K9506M-34	7314151845018	354	30	1	110
K9506M-36	7314151802585	354	30	1	110
K9506M-38	7314151802592	354	30	1	110
K9506M-41	7314151802608	354	30	1	110
K9506M-46	7314151802615	354	30	1	110
K9506M-50	7314151802622	354	30	1	110
K9506M-55	7314151802639	354	30	1	110
K9506M-60	7314151802646	354	30	1	110
K9506Z-1	7314150131686	354	30	1	110
K9506Z-1.1/16	7314150131693	354	30	1	110
K9506Z-1.1/2	7314150131761	354	30	1	110
K9506Z-1.1/4	7314150131723	354	30	1	110
K9506Z-1.13/16	7314150131808	354	30	1	110
K9506Z-1.3/16	7314150131716	354	30	1	110
K9506Z-1.5/8	7314150131785	354	30	1	110
K9506Z-1.7/16	7314150131754	354	30	1	110
K9506Z-1.7/8	7314150131815	354	30	1	110
K9509H5	7314151619428	354	35	1	110
K9509ML-19	7314151618964	354	30	1	110
K9509ML-22	7314151619183	354	30	1	110
K9509ML-24	7314151619268	354	30	1	110
K9560G-0	7314150240012	354	35	1	110
K9560G-1	7314151285944	354	35	1	110
K9560G-2	7314151285951	354	35	1	110
K9560G-3	7314151285968	354	35	1	110
K9560G-4	7314150133970	354	35	1	110
K9560G-5	7314150133987	354	35	1	110
K9564F	7314151286026	354	35	1	108
K9567S	7314151286095	354	35	1	110
K9598H	7314150133956	354	35	1	112
K9801M-100	7314151845162	354	30	1	111
K9801M-105	7314151845179	354	30	1	111
K9801M-110	7314151845186	354	30	1	111
K9801M-115	7314151845193	354	30	1	111
K9801M-120	7314151845209	354	30	1	111
K9801M-125	7314150167159	354	30	1	11

K9801M-90



CUENTA SUBGRUPO



K9801M-90	7314151845148	354	30	1	111
K9801M-95	7314151845155	354	30	1	111
K9801Z-1.1/2	7314150131976	354	30	1	111
K9801Z-1.11/16	7314150132003	354	30	1	111
K9801Z-1.13/16	7314150132027	354	30	1	111
K9801Z-1.15/16	7314150132041	354	30	1	111
K9801Z-1.3/4	7314150132010	354	30	1	111
K9801Z-1.3/8	7314150131952	354	30	1	111
K9801Z-1.5/8	7314150131990	354	30	1	111
K9801Z-1.7/16	7314150131969	354	30	1	111
K9801Z-1.7/8	7314150132034	354	30	1	111
K9801Z-1.9/16	7314150131983	354	30	1	111
K9801Z-2	7314150132058	354	30	1	111
K9801Z-2.1/16	7314150132065	354	30	1	111
K9801Z-2.1/2	7314150132133	354	30	1	111
K9801Z-2.1/4	7314150132096	354	30	1	111
K9801Z-2.1/8	7314150132072	354	30	1	111
K9801Z-2.11/16	7314150132164	354	30	1	111
K9801Z-2.13/16	7314150132188	354	30	1	111
K9801Z-2.15/16	7314150132201	354	30	1	111
K9801Z-2.3/16	7314150132089	354	30	1	111
K9801Z-2.3/4	7314150132171	354	30	1	111
K9801Z-2.3/8	7314150132119	354	30	1	111
K9801Z-2.5/16	7314150132102	354	30	1	111
K9801Z-2.5/8	7314150132157	354	30	1	111
K9801Z-2.7/16	7314150132126	354	30	1	111
K9801Z-2.7/8	7314150132195	354	30	1	111
K9801Z-2.9/16	7314150132140	354	30	1	111
K9801Z-3	7314150132218	354	30	1	111
K9801Z-3.1/16	7314150132225	354	30	1	111
K9801Z-3.1/2	7314150132287	354	30	1	111
K9801Z-3.1/4	7314150132249	354	30	1	111
K9801Z-3.1/8	7314150132232	354	30	1	111
K9801Z-3.11/16	7314150132317	354	30	1	111
K9801Z-3.13/16	7314150132331	354	30	1	111
K9801Z-3.15/16	7314150132355	354	30	1	111
K9801Z-3.3/4	7314150132324	354	30	1	111
K9801Z-3.3/8	7314150132263	354	30	1	111
K9801Z-3.5/16	7314150132256	354	30	1	111
K9801Z-3.5/8	7314150132300	354	30	1	111
K9801Z-3.7/16	7314150132270	354	30	1	111
K9801Z-3.7/8	7314150132348	354	30	1	111
K9801Z-3.9/16	7314150132294	354	30	1	111
K9801Z-4	7314150132362	354	30	1	111
K9801Z-4.1/16	7314150132379	354	30	1	111
K9801Z-4.1/2	7314150132430	354	30	1	111
K9801Z-4.1/4	7314150132393	354	30	1	111
K9801Z-4.1/8	7314150132386	354	30	1	111
K9801Z-4.3/4	7314150132454	354	30	1	111
K9801Z-4.3/8	7314150132416	354	30	1	111
K9801Z-4.5/16	7314150132409	354	30	1	111
K9801Z-4.5/8	7314150132447	354	30	1	111
K9801Z-4.7/16	7314150132423	354	30	1	111
K9806M-100	7314150131105	354	30	1	111
K9806M-105	7314150131112	354	30	1	111
K9806M-110	7314150131129	354	30	1	111
K9806M-115	7314150131136	354	30	1	111
K9806M-120	7314150131143	354	30	1	111
K9806M-41	7314150130986	354	30	1	111
K9806M-46	7314150130993	354	30	1	111
K9806M-50	7314150131006	354	30	1	111
K9806M-55	7314150131013	354	30	1	111
K9806M-60	7314150131020	354	30	1	111
K9806M-65	7314150131037	354	30	1	111
K9806M-70	7314150131044	354	30	1	111
K9806M-75	7314150131051	354	30	1	111
K9806M-80	7314150131068	354	30	1	111
K9806M-85	7314150131075	354	30	1	111
K9806M-90	7314150131082	354	30	1	111
K9806M-95	7314150131099	354	30	1	111
K9806Z-1.1/2	7314150131174	354	30	1	111
K9806Z-1.11/16	7314150131198	354	30	1	111
K9806Z-1.3/8	7314150131150	354	30	1	111
K9806Z-1.5/8	7314150131181	354	30	1	111
K9806Z-1.7/16	7314150131167	354	30	1	111
K9806Z-2	7314150131204	354	30	1	111
K9806Z-2.1/16	7314150131211	354	30	1	111
K9806Z-2.1/2	7314150131273	354	30	1	111
K9806Z-2.1/4	7314150131235	354	30	1	111
K9806Z-2.11/16	7314150131303	354	30	1	111
K9806Z-2.13/16	7314150131327	354	30	1	111
K9806Z-2.15/16	7314150131341	354	30	1	111
K9806Z-2.3/16	7314150131228	354	30	1	111
K9806Z-2.3/4	7314150131310	354	30	1	111
K9806Z-2.3/8	7314150131259	354	30	1	111
K9806Z-2.5/16	7314150131242	354	30	1	111
K9806Z-2.5/8	7314150131297	354	30	1	111
K9806Z-2.7/16	7314150131266	354	30	1	111
K9806Z-2.7/8	7314150131334	354	30	1	111
K9806Z-2.9/16	7314150131280	354	30	1	111
K9806Z-3	7314150131358	354	30	1	111
K9806Z-3.1/16	7314150131365	354	30	1	111
K9806Z-3.1/2	7314150131433	354	30	1	111
K9806Z-3.1/4	7314150131396	354	30	1	111
K9806Z-3.1/8	7314150131372	354	30	1	111
K9806Z-3.11/16	7314150131464	354	30	1	111
K9806Z-3.13/16	7314150131488	354	30	1	111
K9806Z-3.15/16	7314150131501	354	30	1	111



CUENTA SUBGRUPO



K9806Z-3.3/16	7314150131389	354	30	1	111
K9806Z-3.3/4	7314150131471	354	30	1	111
K9806Z-3.3/8	7314150131419	354	30	1	111
K9806Z-3.5/16	7314150131402	354	30	1	111
K9806Z-3.5/8	7314150131457	354	30	1	111
K9806Z-3.7/16	7314150131426	354	30	1	111
K9806Z-3.7/8	7314150131495	354	30	1	111
K9806Z-3.9/16	7314150131440	354	30	1	111
K9806Z-4	7314150131518	354	30	1	111
K9806Z-4.1/16	7314150131525	354	30	1	111
K9806Z-4.1/2	7314150131570	354	30	1	111
K9806Z-4.1/4	7314150131549	354	30	1	111
K9806Z-4.1/8	7314150131532	354	30	1	111
K9806Z-4.3/4	7314150131594	354	30	1	111
K9806Z-4.3/8	7314150131563	354	30	1	111
K9806Z-4.5/16	7314150131556	354	30	1	111
K9806Z-4.5/8	7314150131587	354	30	1	111
K9860H-1	7314150133994	354	35	1	112
K9860H-2	7314150134007	354	35	1	112
K9860H-3	7314150134014	354	35	1	112
K9867S	7314150133932	354	35	1	112
K9895G	7314150133949	354	35	1	110
K9899H	7314150166763	354	35	1	112
K9998H	7314150133963	354	35	1	112
KB09-01	7314150196968	334	10	5	520
KB18-01	7314150196944	334	10	5	520
KBFU-01	7314150196913	334	10	5	520
KBGH-5P-DISPEN	7314150296729	334	15	20	520
KBGR-5P-DISPEN	7314150296774	334	15	20	520
KBGU-100P	7314150213405	334	15	1	520
KBGU-10P-DISPEN	7314150262984	334	15	20	520
KBGU-5P-DISPEN	7314150296705	334	15	20	520
KBRU-01	7314150196876	334	10	5	519
KBSK-01	7314150196999	334	10	5	522
KBSU-01	7314150197002	334	10	5	522
KBTU-01	7314150196982	334	10	5	521
KBWS-01	7314150225972	334	10	10	524
KCB753	7314150204915	346	52	1	157
KE18-01	7314150196937	334	10	5	519
KEFU-01	7314150196906	334	10	5	519
KERU-01	7314150196869	334	10	5	519
KG09-01	7314150196975	334	10	5	521
KG09-01-3P	7314150213962	334	10	10	521
KG18-01	7314150196951	334	10	5	521
KGAU-01	7314150223893	334	10	5	521
KGFU-01	7314150196920	334	10	5	520
KGRU-01	7314150196883	334	10	5	519
KGRU-02	7314150196890	334	10	5	519
KGSU-01	7314150197019	334	10	5	522
KHU-01	7314150268955	334	10	4	521
KM1/4-5/16-1P	7314150275953	346	52	50	157
KM100-SH	7314150215690	346	52	1	156
KM653	7314151786915	346	52	1	156
KM653-1P	7314151840709	346	52	25	156
KM653-QR	7314150115983	346	52	1	156
KM653-QR-1P	7314151848507	346	52	1	156
KM653-SF	7314150204984	346	52	1	156
KM6701M-10	7314151844264	354	30	1	102
KM6701M-7	7314151844240	354	30	1	102
KM6701M-8	7314151844257	354	30	1	102
KM6750-1/4	7314150204595	346	48	1	159
KM6750-10	7314150204649	346	52	20	159
KM6750-11	7314150302628	346	52	1	159
KM6750-13	7314150204632	346	52	1	159
KM6750-3/8	7314150204588	346	48	1	159
KM6750-6	7314150204601	346	48	1	159
KM6750-7	7314150204618	346	52	1	159
KM6750-8	7314150204625	346	52	1	159
KM753-QR-1P	7314150204830	346	52	1	156
KMR150	7314150204960	346	52	1	157
KMR150-1P	7314150204977	346	52	1	157
KMR653	7314150204922	346	52	1	156
KMR653-1P	7314150204939	346	52	1	156
KMR753	7314150204946	346	52	1	156
KMR753-1P	7314150204953	346	52	1	156
KMU-01	7314150197026	334	10	5	519
KR653	7314150204885	346	52	1	156
KR653-1P	7314150260263	346	52	25	156
KRSS-01	7314150214938	334	10	10	524
KS7401M-10	7314150384495	354	30	1	103
KS7401M-11	7314150384501	354	30	1	103
KS7401M-12	7314150384518	354	30	1	103



KUBG18-5P	7314150213443	334	15	20	521
L1020C06	7311518182113	346	15	1	146
L1020F06	7311518182106	346	15	1	146
L1020M06	7311518133665	346	15	1	146
L1020M06X	7311518136369	346	15	1	146
L1225F06	7311518192860	346	15	1	146
L1225M06	7311518132774	346	15	1	146
L1225M06X	7311518136857	346	15	1	146
L1230AL06	7311518187668	346	15	1	144
L1230AL08	7311518181871	346	15	1	144
L1230C06	7311518182120	346	15	1	146
L1230F06	7311518182137	346	15	1	146
L1230M06	7311518182168	346	15	1	146
L1230M06X	7311518182175	346	15	1	146
L1630C06	7311518192938	346	15	1	146
L1630C08	7311518182144	346	15	1	146
L1630F06	7311518192921	346	15	1	146
L1630F08	7311518182151	346	15	1	146
L1630M06	7311518192914	346	15	1	146
L1630M06X	7311518187446	346	15	1	146
L1630M08	7311518182205	346	15	1	146
L1630M08X	7311518136833	346	15	1	146
LAP-KNIFE	7311518216443	330	20	10	569
LS-6160-23	7311518041304	352	35	1	571
LS-COIN 19 CM	7311518031077	326	15	4	539
LS-COIN 26 CM	7311518333041	326	15	2	539
LS-COMBINESS	7311518041366	352	35	1	570
LS-MASSE-4	7311518012014	326	15	2	539
LS-MASSE-4FG	7311518275891	326	15	2	539
LS-MASSE-TR-4FG	7311518281106	326	15	2	539
LS-MERLIN-2.5	7311518012069	326	15	2	539
LS-MERLIN-2.5FG	7311518281113	326	15	2	539
LS-NATURAL	7311518224622	352	35	1	570
LS-PIERRE CORINDON	7311518009977	352	35	1	570
LS-PIERRE-FAUX	7311518009038	352	35	1	571
LS-TRIANGLE	7311518224653	352	35	1	570
LST-30111	7314150337262	320	10	5	552
LST-32011	7314150337279	320	10	5	552
LST-40311	7314150337309	320	10	5	553
LST-41312	7314150337293	320	10	5	552
LST-42312	7314150337286	320	10	5	552
LST-50123	7314150337248	320	10	5	554
LST-51121	7314150337231	320	10	5	554
LST-52102	7314150337347	320	10	5	554
LST-52121	7314150337224	320	10	5	554
LST-61121	7314150337187	320	10	5	554
LST-62121	7314150337194	320	10	5	554
LST-63102	7314150337330	320	10	5	554
LST-70120	7314150337255	320	10	5	552
LST-72324	7314150337163	320	10	5	552
LST-73524	7314150337170	320	10	5	552
LST-80121	7314150337200	320	10	5	552
LST-99102	7314150337354	320	10	4	554
LT-STEEL-30	7314150138012	336	15	5	483
LT-STEEL-50	7314150138029	336	15	5	483
LTB-10	7314150120048	336	15	6	483
LTB-20	7314150120062	336	15	6	483
LTB-30	7314150120086	336	15	6	483
LTG-10	7314150119981	336	15	6	483
LTG-20	7314150120000	336	15	6	483
LTG-30	7314150120024	336	15	6	483
LTS-100	7314150120147	336	15	5	483
LTS-100-E	7314150120154	336	15	5	483
LTS-30	7314150120109	336	15	5	483
LTS-30-E	7314150120116	336	15	5	483
LTS-50	7314150120123	336	15	5	483
LTS-50-E	7314150120130	336	15	5	483
LUB-2015	7311518335427	352	35	6	571
M0310C03	7311518036812	346	15	1	146
M0310F03	7311518036799	346	15	1	146
M0310M03	7311518036805	346	15	1	146
M0310M03X	7311518197063	346	15	1	146
M0613M03X	7311518196622	346	15	1	146
M0618C06	7311518036867	346	15	1	146
M0618F06	7311518036829	346	15	1	146
M0618M06	7311518036836	346	15	1	146
M0618M06X	7311518036850	346	15	1	146
M1022C06	7311518036911	346	15	1	146
M1022F06	7311518036874	346	15	1	146
M1022M06	7311518036881	346	15	1	146
M1022M06D	7311518210762	346	15	1	146
M1022M06X	7311518036904	346	15	1	146
M1227C06	7311518036966	346	15	1	146
M1227C08	7311518192983	346	15	1	146
M1227F06	7311518036935	346	15	1	146
M1227F08	7311518036973	346	15	1	146
M1227M06	7311518036928	346	15	1	146
M1227M06X	7311518036959	346	15	1	146
M1227M08	7311518036980	346	15	1	146
M1227M08X	7311518192990	346	15	1	146
M126	7311518160920	340	70	4	517
M1630C06	7311518193034	346	15	1	146
M1630C08	7311518037093	346	15	1	146
M1630F06	7311518193027	346	15	1	146
M1630F08	7311518037055	346	15	1	146
M1630M06	7311518193010	346	15	1	146
M1630M06X	7311518187453	346	15	1	146
M1630M08	7311518037062	346	15	1	146



M1630M08X	7311518037086	346	15	1	146
M227L	7311518160883	340	70	4	517
M227R	7311518160869	340	70	4	517
M330	7311518160906	340	70	4	517
M526	7311518160982	340	70	4	517
M6376	7311518196486	340	70	1	518
M6376-SH	7311518199296	340	70	1	518
M676	7311518161088	340	70	1	518
M676-SH	7311518211875	340	70	1	518
M722	7311518160937	340	70	4	517
M726	7311518160944	340	70	4	517
M730	7311518160968	340	70	2	517
M780	7314151826215	350	46	1	197
M781	7314153016218	350	46	5	197
M926	7311518161071	340	70	1	518
M926-SH	7314150107537	340	70	1	518
MA225	7311518161057	340	70	4	516
MA225L	7311518161033	340	70	4	516
MA225R	7311518161040	340	70	4	516
MA311	7314150181568	340	70	10	516
MA321	7314150181551	340	70	10	516
MA325	7311518161064	340	70	4	516
MA351	7314150181582	340	70	10	517
MA361	7314150181575	340	70	10	516
MA401	7314150167593	340	70	10	516
MA411	7314150167609	340	70	10	516
MA421	7314150167616	340	70	10	516
MA431	7314150181544	340	70	1	516
MA500-1	7314150112395	360	25	1	589
MA500-2	7314150112401	360	25	1	589
MA500-3	7314150112418	360	25	1	589
MAM50M	7314150215300	360	20	1	120
MCP-2.5-810	7311518124052	326	15	2	538
MES-3.0-900	7311518123864	326	15	2	539
MES-3.5-900	7311518123871	326	15	2	539
MES-3.5-900FG	7311518281120	326	15	2	539
MK5	7314150224333	366	30	1	60
MK9	7314150224326	366	30	1	61
MR126	7311518161019	340	70	4	517
MR227L	7311518161002	340	70	4	517
MR227R	7311518160999	340	70	4	517
MR340	7311518197537	340	70	2	516
MR726	7311518161026	340	70	4	518
MT-TS-3	7314150194995	336	15	12	482
MTB-3-16	7314150119066	336	15	6	482
MTB-3-16-M	7314150119073	336	15	6	482
MTB-3-16-M-E	7314150119141	336	15	6	482
MTB-5-25	7314150119080	336	15	6	482
MTB-5-25-C1	7314150119127	336	15	6	482
MTB-5-25-M	7314150119097	336	15	6	482
MTB-5-25-M-E	7314150119158	336	15	6	482
MTB-8-25	7314150125418	336	15	6	482
MTB-8-25-M	7314150127078	336	15	6	482
MTB-8-25-M-E	7314150127085	336	15	6	482
MTC-3-13	7314150321322	336	15	6	482
MTC-3-13-C1	7314150330843	336	15	6	482
MTC-5-16	7314150321339	336	15	6	482
MTC-5-16-C1	7314150330850	336	15	6	482
MTG-3-16	7314150118984	336	15	12	482
MTG-3-16-E	7314150119028	336	15	12	482
MTG-5-19	7314150118991	336	15	12	482
MTG-5-19-E	7314150119035	336	15	12	482
MTG-8-25	7314150330348	336	15	4	482
MTG-8-25-E	7314150390809	336	15	4	482
MTS-5-25	7314150119233	336	15	6	482
MTS-5-25-E	7314150119271	336	15	6	482
MTS-8-25	7314150119257	336	15	6	482
MTS-8-25-E	7314150119295	336	15	6	482
MTT051	7314150270521	334	25	6	524
MTT121	7314150213290	334	25	8	524
MTT151	7314150120703	334	25	6	523
MW-150	7314150125685	336	15	2	483
MW-250	7314150125678	336	15	2	483
N0306C03	7311518193065	346	15	1	146
N0306F03	7311518193058	346	15	1	146
N0306M03	7311518182212	346	15	1	146
N0306M03E	7311518182229	346	15	1	146
N0607C06	7311518193089	346	15	1	146
N0607F06	7311518193072	346	15	1	146
N0607M06	7311518182236	346	15	1	146
N0607M06E	7311518182243	346	15	1	146
N1213C06	7311518193102	346	15	1	146
N1213F06	7311518193096	346	15	1	146
N1213M06	7311518134570	346	15	1	146
N1213M06E	7311518182250	346	15	1	146
N1213M06X	7311518237172	346	15	1	146
N1613C06	7311518193133	346	15	1	146
N1613C08	7311518193157	346	15	1	146
N1613F06	7311518193126	346	15	1	146
N1613F08	7311518193140	346	15	1	146
N1613M06	7311518136000	346	15	1	146
N1613M06E	7311518193119	346	15	1	146
N1613M06X	7311518204525	346	15	1	146
N1613M08	7311518182267	346</			

NP-16-U7/8-HP

		CUENTA	SUBGRUPO		
NP-16-U7/8-HP	7311518241773	330	10	4	503
NP-19-U7/8-HP	7311518241452	330	10	10	503
NP-22-F7/8-HP	7311518035204	330	10	10	503
NP-22-U7/8-HP	7311518034399	330	10	10	503
NS001-150	7314150316069	348	80	1	448
NS001-200	7314150316076	348	80	1	448
NS001-250	7314150316083	348	80	1	448
NS001-300	7314150316090	348	80	1	448
NS001-375	7314150325108	348	80	1	448
NS001-450	7314150325115	348	80	1	448
NS001-600	7314150325122	348	80	1	448
NS001-900	7314150325139	348	80	1	448
NS002-10	7314150284719	348	80	1	448
NS002-11	7314150292592	348	80	1	448
NS002-12	7314150292608	348	80	1	448
NS002-13	7314150284726	348	80	1	448
NS002-14	7314150284733	348	80	1	448
NS002-15	7314150292615	348	80	1	448
NS002-16	7314150292622	348	80	1	448
NS002-17	7314150284740	348	80	1	448
NS002-18	7314150292639	348	80	1	448
NS002-19	7314150284757	348	80	1	448
NS002-20	7314150292646	348	80	1	448
NS002-21	7314150292653	348	80	1	448
NS002-22	7314150292660	348	80	1	448
NS002-23	7314150292677	348	80	1	448
NS002-24	7314150292684	348	80	1	448
NS002-25	7314150292691	348	80	1	448
NS002-26	7314150292707	348	80	1	448
NS002-27	7314150284764	348	80	1	448
NS002-28	7314150292714	348	80	1	448
NS002-29	7314150292721	348	80	1	448
NS002-30	7314150292738	348	80	1	448
NS002-31	7314150292745	348	80	1	448
NS002-32	7314150284771	348	80	1	448
NS002-33	7314150292752	348	80	1	448
NS002-34	7314150292769	348	80	1	448
NS002-35	7314150292776	348	80	1	448
NS002-36	7314150284788	348	80	1	448
NS002-38	7314150292783	348	80	1	448
NS002-40	7314150292790	348	80	1	448
NS002-41	7314150292806	348	80	1	448
NS002-42	7314150292813	348	80	1	448
NS002-46	7314150292820	348	80	1	448
NS002-50	7314150292837	348	80	1	448
NS002-52	7314150292844	348	80	1	448
NS002-55	7314150292851	348	80	1	448
NS002-6	7314150292554	348	80	1	448
NS002-60	7314150292868	348	80	1	448
NS002-65	7314150292875	348	80	1	448
NS002-7	7314150292561	348	80	1	448
NS002-70	7314150292882	348	80	1	448
NS002-75	7314150292899	348	80	1	448
NS002-8	7314150292578	348	80	1	448
NS002-80	7314150292905	348	80	1	448
NS002-9	7314150292585	348	80	1	448
NS006-0607	7314150292912	348	80	1	449
NS006-0608	7314150292929	348	80	1	449
NS006-0708	7314150292936	348	80	1	449
NS006-0709	7314150292943	348	80	1	449
NS006-0809	7314150292967	348	80	1	449
NS006-0810	7314150292950	348	80	1	449
NS006-0910	7314150292974	348	80	1	449
NS006-0911	7314150292981	348	80	1	449
NS006-1011	7314150292998	348	80	1	449
NS006-1012	7314150293001	348	80	1	449
NS006-1013	7314150293018	348	80	1	449
NS006-1014	7314150293025	348	80	1	449
NS006-1113	7314150293032	348	80	1	449
NS006-1114	7314150293049	348	80	1	449
NS006-1213	7314150293056	348	80	1	449
NS006-1214	7314150293063	348	80	1	449
NS006-1315	7314150293070	348	80	1	449
NS006-1415	7314150293087	348	80	1	449
NS006-1416	7314150293094	348	80	1	449
NS006-1417	7314150293100	348	80	1	449
NS006-1617	7314150293117	348	80	1	449
NS006-1618	7314150293124	348	80	1	449
NS006-1719	7314150293131	348	80	1	449
NS006-1722	7314150293148	348	80	1	449
NS006-1819	7314150293155	348	80	1	449
NS006-1820	7314150293162	348	80	1	449
NS006-1920	7314150293179	348	80	1	449
NS006-1922	7314150293186	348	80	1	449
NS006-1924	7314150293193	348	80	1	449
NS006-2022	7314150293209	348	80	1	449
NS006-2122	7314150293216	348	80	1	449
NS006-2123	7314150293223	348	80	1	449
NS006-2223	7314150293230	348	80	1	449
NS006-2224	7314150293247	348	80	1	449
NS006-2227	7314150293254	348	80	1	449
NS006-2326	7314150293261	348	80	1	449
NS006-2425	7314150293278	348	80	1	449
NS006-2426	7314150293285	348	80	1	449
NS006-2427	7314150293292	348	80	1	449
NS006-2430	7314150293308	348	80	1	449
NS006-2528	7314150293315	348	80	1	449
NS006-2629	7314150293322	348	80	1	449

		CUENTA	SUBGRUPO		
NS006-2729	7314150293339	348	80	1	449
NS006-2730	7314150293346	348	80	1	449
NS006-2732	7314150293353	348	80	1	449
NS006-2830	7314150293360	348	80	1	449
NS006-3031	7314150293377	348	80	1	449
NS006-3032	7314150293384	348	80	1	449
NS006-3034	7314150293391	348	80	1	449
NS006-3036	7314150293407	348	80	1	449
NS006-3234	7314150293414	348	80	1	449
NS006-3235	7314150293421	348	80	1	449
NS006-3236	7314150293438	348	80	1	449
NS006-3335	7314150293445	348	80	1	449
NS006-3436	7314150293452	348	80	1	449
NS006-3536	7314150293469	348	80	1	449
NS006-3638	7314150293476	348	80	1	449
NS006-3641	7314150293483	348	80	1	449
NS006-3642	7314150293490	348	80	1	449
NS006-4146	7314150293506	348	80	1	449
NS006-4650	7314150293513	348	80	1	449
NS006-5052	7314150293520	348	80	1	449
NS006-5055	7314150293537	348	80	1	449
NS006-5060	7314150293544	348	80	1	449
NS006-5062	7314150293551	348	80	1	449
NS006-5560	7314150293568	348	80	1	449
NS006-6065	7314150293575	348	80	1	449
NS006-6570	7314150293582	348	80	1	449
NS010-0607	7314150293599	348	80	1	449
NS010-0709	7314150293605	348	80	1	449
NS010-0809	7314150293612	348	80	1	449
NS010-0911	7314150293629	348	80	1	449
NS010-1011	7314150293636	348	80	1	449
NS010-1012	7314150293643	348	80	1	449
NS010-1214	7314150293650	348	80	1	449
NS010-1315	7314150293667	348	80	1	449
NS010-1417	7314150293674	348	80	1	449
NS010-1618	7314150293681	348	80	1	449
NS010-1719	7314150293698	348	80	1	449
NS010-1722	7314150293704	348	80	1	449
NS010-1819	7314150293711	348	80	1	449
NS010-1921	7314150293728	348	80	1	449
NS010-1922	7314150293735	348	80	1	449
NS010-2022	7314150293742	348	80	1	449
NS010-2123	7314150293759	348	80	1	449
NS010-2224	7314150293766	348	80	1	449
NS010-2427	7314150293773	348	80	1	449
NS010-2528	7314150293780	348	80	1	449
NS010-2628	7314150293797	348	80	1	449
NS010-2730	7314150293803	348	80	1	449
NS010-2732	7314150293810	348	80	1	449
NS010-3032	7314150293827	348	80	1	449
NS010-3036	7314150293834	348	80	1	449
NS010-3236	7314150293841	348	80	1	449
NS010-3641	7314150293858	348	80	1	449
NS010-4146	7314150293865	348	80	1	449
NS010-4650	7314150293872	348	80	1	449
NS011-0607	7314150317271	348	80	1	450
NS011-0809	7314150317288	348	80	1	450
NS011-1011	7314150317295	348	80	1	450
NS011-1213	7314150317301	348	80	1	450
NS011-1415	7314150317318	348	80	1	450
NS011-1617	7314150317325	348	80	1	450
NS011-1819	7314150317332	348	80	1	450
NS011-2022	7314150317349	348	80	1	450
NS011-2123	7314150317356	348	80	1	450
NS011-2426	7314150317363	348	80	1	450
NS011-2528	7314150317370	348	80	1	450
NS011-2729	7314150317387	348	80	1	450
NS011-3032	7314150317394	348	80	1	450
NS100-100	7314150294305	348	80	1	450
NS100-105	7314150294312	348	80	1	450
NS100-110	7314150294329	348	80	1	450
NS100-115	7314150294336	348	80	1	450
NS100-120	7314150294343	348	80	1	450
NS100-17	7314150293889	348	80	1	450
NS100-19	7314150293896	348	80	1	450
NS100-22	7314150293902	348	80	1	450
NS100-24	7314150293919	348	80	1	450
NS100-25	7314150293926	348	80	1	450
NS100-27	7314150293933	348	80	1	450
NS100-28	7314150293940	348	80	1	450
NS100-29	7314150293957	348	80	1	450
NS100-30	7314150293964	348	80	1	450
NS100-32	7314150293971	348	80	1	450
NS100-33	7314150293988	348	80	1	450
NS100-34	7314150293995	348	80	1	450
NS100-35	7314150294008	348	80	1	450
NS100-36	7314150294015	348	80	1	450
NS100-37	7314150294022	348	80	1	450



CUENTA SUBGRUPO



NS100-56	7314150294138	348	80	1	450
NS100-58	7314150294145	348	80	1	450
NS100-60	7314150294152	348	80	1	450
NS100-63	7314150294169	348	80	1	450
NS100-65	7314150294176	348	80	1	450
NS100-67	7314150294183	348	80	1	450
NS100-70	7314150294190	348	80	1	450
NS100-71	7314150294206	348	80	1	450
NS100-75	7314150294213	348	80	1	450
NS100-77	7314150294220	348	80	1	450
NS100-80	7314150294237	348	80	1	450
NS100-82	7314150294244	348	80	1	450
NS100-85	7314150294251	348	80	1	450
NS100-88	7314150294268	348	80	1	450
NS100-90	7314150294275	348	80	1	450
NS100-94	7314150294282	348	80	1	450
NS100-95	7314150294299	348	80	1	450
NS104-100	7314150294947	348	80	1	451
NS104-105	7314150294954	348	80	1	451
NS104-110	7314150294961	348	80	1	451
NS104-115	7314150294978	348	80	1	451
NS104-120	7314150294985	348	80	1	451
NS104-17	7314150294350	348	80	1	451
NS104-19	7314150294367	348	80	1	451
NS104-20	7314150294374	348	80	1	451
NS104-22	7314150294381	348	80	1	451
NS104-24	7314150284795	348	80	1	451
NS104-25	7314150294398	348	80	1	451
NS104-26	7314150294404	348	80	1	451
NS104-27	7314150284801	348	80	1	451
NS104-28	7314150294411	348	80	1	451
NS104-29	7314150294428	348	80	1	451
NS104-30	7314150284818	348	80	1	451
NS104-31	7314150294435	348	80	1	451
NS104-32	7314150284825	348	80	1	451
NS104-33	7314150294442	348	80	1	451
NS104-34	7314150294459	348	80	1	451
NS104-35	7314150294466	348	80	1	451
NS104-36	7314150284832	348	80	1	451
NS104-37	7314150294473	348	80	1	451
NS104-38	7314150294480	348	80	1	451
NS104-39	7314150294497	348	80	1	451
NS104-40	7314150294503	348	80	1	451
NS104-41	7314150284849	348	80	1	451
NS104-42	7314150294510	348	80	1	451
NS104-43	7314150294527	348	80	1	451
NS104-44	7314150294534	348	80	1	451
NS104-45	7314150294541	348	80	1	451
NS104-46	7314150284856	348	80	1	451
NS104-47	7314150294558	348	80	1	451
NS104-48	7314150294565	348	80	1	451
NS104-49	7314150294572	348	80	1	451
NS104-50	7314150284863	348	80	1	451
NS104-51	7314150294589	348	80	1	451
NS104-52	7314150294596	348	80	1	451
NS104-53	7314150294602	348	80	1	451
NS104-54	7314150294619	348	80	1	451
NS104-55	7314150284870	348	80	1	451
NS104-56	7314150294626	348	80	1	451
NS104-57	7314150294633	348	80	1	451
NS104-58	7314150294640	348	80	1	451
NS104-59	7314150294657	348	80	1	451
NS104-60	7314150284887	348	80	1	451
NS104-61	7314150294664	348	80	1	451
NS104-62	7314150294671	348	80	1	451
NS104-63	7314150294688	348	80	1	451
NS104-64	7314150294695	348	80	1	451
NS104-65	7314150294701	348	80	1	451
NS104-66	7314150294718	348	80	1	451
NS104-67	7314150294725	348	80	1	451
NS104-68	7314150294732	348	80	1	451
NS104-69	7314150294749	348	80	1	451
NS104-70	7314150284894	348	80	1	451
NS104-71	7314150294756	348	80	1	451
NS104-72	7314150294763	348	80	1	451
NS104-73	7314150294770	348	80	1	451
NS104-74	7314150294787	348	80	1	451
NS104-75	7314150284900	348	80	1	451
NS104-76	7314150294794	348	80	1	451
NS104-77	7314150294800	348	80	1	451
NS104-78	7314150294817	348	80	1	451
NS104-79	7314150294824	348	80	1	451
NS104-80	7314150284917	348	80	1	451
NS104-81	7314150294831	348	80	1	451
NS104-82	7314150294848	348	80	1	451
NS104-83	7314150294855	348	80	1	451
NS104-84	7314150294862	348	80	1	451
NS104-85	7314150284924	348	80	1	451
NS104-86	7314150294879	348	80	1	451
NS104-87	7314150294886	348	80	1	451
NS104-88	7314150294893	348	80	1	451
NS104-89	7314150294909	348	80	1	451
NS104-90	7314150284931	348	80	1	451
NS104-92	7314150294916	348	80	1	451
NS104-94	7314150294923	348	80	1	451
NS104-95	7314150284948	348	80	1	451
NS104-98	7314150294930	348	80	1	451
NS106-100	7314150295418	348	80	1	452



CUENTA SUBGRUPO



NS106-104	7314150295425	348	80	1	452
NS106-108	7314150295432	348	80	1	452
NS106-112	7314150295449	348	80	1	452
NS106-114	7314150295456	348	80	1	452
NS106-116	7314150295463	348	80	1	452
NS106-120	7314150295470	348	80	1	452
NS106-124	7314150295487	348	80	1	452
NS106-126	7314150295494	348	80	1	452
NS106-128	7314150295500	348	80	1	452
NS106-132	7314150295517	348	80	1	452
NS106-136	7314150295524	348	80	1	452
NS106-138	7314150295531	348	80	1	452
NS106-144	7314150295548	348	80	1	452
NS106-146	7314150295555	348	80	1	452
NS106-150	7314150295562	348	80	1	452
NS106-156	7314150295579	348	80	1	452
NS106-158	7314150295586	348	80	1	452
NS106-20	7314150294992	348	80	1	452
NS106-22	7314150295005	348	80	1	452
NS106-24	7314150295012	348	80	1	452
NS106-25	7314150295029	348	80	1	452
NS106-26	7314150295036	348	80	1	452
NS106-28	7314150295043	348	80	1	452
NS106-30	7314150295050	348	80	1	452
NS106-32	7314150295067	348	80	1	452
NS106-34	7314150295074	348	80	1	452
NS106-36	7314150295081	348	80	1	452
NS106-38	7314150295098	348	80	1	452
NS106-40	7314150295104	348	80	1	452
NS106-42	7314150295111	348	80	1	452
NS106-44	7314150295128	348	80	1	452
NS106-45	7314150295135	348	80	1	452
NS106-46	7314150295142	348	80	1	452
NS106-48	7314150295159	348	80	1	452
NS106-50	7314150295166	348	80	1	452
NS106-52	7314150295173	348	80	1	452
NS106-54	7314150295180	348	80	1	452
NS106-56	7314150295197	348	80	1	452
NS106-58	7314150295203	348	80	1	452
NS106-60	7314150295210	348	80	1	452
NS106-62	7314150295227	348	80	1	452
NS106-64	7314150295234	348	80	1	452
NS106-66	7314150295241	348	80	1	452
NS106-68	7314150295258	348	80	1	452
NS106-70	7314150295265	348	80	1	452
NS106-71	7314150295272	348	80	1	452
NS106-72	7314150295289	348	80	1	452
NS106-74	7314150295296	348	80	1	452
NS106-76	7314150295302	348	80	1	452
NS106-78	7314150295319	348	80	1	452
NS106-80	7314150295326	348	80	1	452
NS106-82	7314150295333	348	80	1	452
NS106-84	7314150295340	348	80	1	452
NS106-88	7314150295357	348	80	1	452
NS106-90	7314150295364	348	80	1	452
NS106-92	7314150295371	348	80	1	452
NS106-94	7314150295388	348	80	1	452
NS106-96	7314150295395	348	80	1	452
NS106-98	7314150295401	348	80	1	452
NS200-1200	7314150295661	348	80	1	452
NS200-200	7314150295593	348	80	1	452
NS200-250	7314150295609	348	80	1	452
NS200-300	7314150295616	348	80	1	452
NS200-350	7314150295623	348	80	1	452
NS200-450	7314150295630	348	80	1	452
NS200-600	7314150295647	348	80	1	452
NS200-900	7314150295654	348	80	1	452
NS202-350	7314150299690	348	80	1	453
NS203-200	7314150359509	348	80	1	453
NS203-215	7314150359516	348	80	1	453
NS203-290	7314150359523	348	80	1	453
NS203-400	7314150359530	348	80	1	453
NS203-490	7314150359547	348	80	1	453
NS203-800	7314150359554	348	80	1	453
NS204-30	7314150295685	348	80	1	453
NS204-32	7314150295692	348	80	1	453
NS204-35	7314150295708	348	80	1	453
NS204-40	7314150295715	348	80	1	453
NS204-45	7314150295722	348	80	1	453
NS204-48	7314150295739	348	80	1	453
NS204-50	7314150295746	348	80	1	453
NS204-55	7314150295753	348	80	1	453
NS204-60	7314150295760	348	80	1	453
NS204-65	7314150295777	348	80	1	453
NS204-70	7314150295784	348	80	1	453
NS204-75	7314150295791	348	80	1	453
NS204-80	7314150295807	348	80	1	453
NS204-85	7314150295814	348	80	1	453</



NS220-15	7314150347308	348	80	1	453
NS220-16	7314150347315	348	80	1	453
NS220-17	7314150347322	348	80	1	453
NS220-18	7314150347339	348	80	1	453
NS220-19	7314150347346	348	80	1	453
NS220-20	7314150347353	348	80	1	453
NS220-21	7314150347360	348	80	1	453
NS220-22	7314150347377	348	80	1	453
NS220-23	7314150347384	348	80	1	453
NS220-24	7314150347391	348	80	1	453
NS220-25	7314150347407	348	80	1	453
NS220-26	7314150347414	348	80	1	453
NS220-27	7314150347421	348	80	1	453
NS220-28	7314150347438	348	80	1	453
NS220-29	7314150347445	348	80	1	453
NS220-30	7314150347452	348	80	1	453
NS220-32	7314150347469	348	80	1	453
NS224-17	7314150355525	348	80	1	454
NS224-18	7314150355532	348	80	1	454
NS224-19	7314150355549	348	80	1	454
NS224-21	7314150355556	348	80	1	454
NS224-22	7314150355563	348	80	1	454
NS224-23	7314150355570	348	80	1	454
NS224-24	7314150355587	348	80	1	454
NS224-26	7314150355594	348	80	1	454
NS224-27	7314150355617	348	80	1	454
NS224-28	7314150355624	348	80	1	454
NS224-29	7314150355631	348	80	1	454
NS224-30	7314150355648	348	80	1	454
NS224-32	7314150355655	348	80	1	454
NS224-34	7314150355662	348	80	1	454
NS224-36	7314150355679	348	80	1	454
NS224-38	7314150355686	348	80	1	454
NS224-41	7314150355693	348	80	1	454
NS224-46	7314150355709	348	80	1	454
NS224-50	7314150355716	348	80	1	454
NS228-22	7314150355914	348	80	1	454
NS228-24	7314150355921	348	80	1	454
NS228-26	7314150355938	348	80	1	454
NS228-27	7314150355945	348	80	1	454
NS228-28	7314150355952	348	80	1	454
NS228-29	7314150355969	348	80	1	454
NS228-30	7314150355976	348	80	1	454
NS228-31	7314150355983	348	80	1	454
NS228-32	7314150355990	348	80	1	454
NS228-34	7314150356003	348	80	1	454
NS228-36	7314150356010	348	80	1	454
NS228-38	7314150356027	348	80	1	454
NS228-41	7314150356034	348	80	1	454
NS228-46	7314150356041	348	80	1	454
NS228-50	7314150356058	348	80	1	454
NS228-55	7314150356065	348	80	1	454
NS228-60	7314150356072	348	80	1	454
NS228-65	7314150356089	348	80	1	454
NS228-70	7314150356096	348	80	1	454
NS228-75	7314150356102	348	80	1	454
NS228-80	7314150356119	348	80	1	454
NS232-16-24	7314150356331	348	80	1	455
NS232-24-16	7314150356355	348	80	1	455
NS232-24-32	7314150356348	348	80	1	455
NS232-32-24	7314150356362	348	80	1	455
NS234-16-100	7314150356416	348	80	1	455
NS234-16-200	7314150356423	348	80	1	455
NS234-16-250	7314150356430	348	80	1	455
NS234-24-200	7314150356447	348	80	1	455
NS234-32-250	7314150356454	348	80	1	455
NS236-16	7314150356522	348	80	1	455
NS236-24	7314150356539	348	80	1	455
NS236-32	7314150356515	348	80	1	455
NS238-16-250	7314150356577	348	80	1	455
NS238-24-250	7314150356584	348	80	1	455
NS238-32-300	7314150356591	348	80	1	455
NS240-16-230	7314150356737	348	80	1	455
NS242-16	7314150356638	348	80	1	456
NS242-24	7314150356645	348	80	1	456
NS242-32	7314150356652	348	80	1	456
NS243-16-400	7314150356690	348	80	1	456
NS247-26	7314150356751	348	80	1	456
NS248-16-52	7314150356713	348	80	1	456
NS300-10-200	7314150317783	348	80	1	457
NS300-10-300	7314150316205	348	80	1	457
NS300-11-250	7314150317790	348	80	1	457
NS300-11-300	7314150317806	348	80	1	457
NS300-11-350	7314150316212	348	80	1	457
NS300-12-400	7314150325153	348	80	1	457
NS300-13-450	7314150325160	348	80	1	457
NS300-3-50	7314150317677	348	80	1	457
NS300-3-75	7314150317684	348	80	1	457
NS300-4-75	7314150317691	348	80	1	457
NS300-4-5-100	7314150316175	348	80	1	457
NS300-4-5-50	7314150317707	348	80	1	457
NS300-5-100	7314150317721	348	80	1	457
NS300-5-75	7314150317714	348	80	1	457
NS300-6-100	7314150316182	348	80	1	457
NS300-6-125	7314150317738	348	80	1	457
NS300-6-150	7314150317745	348	80	1	457
NS300-7-150	7314150317752	348	80	1	457
NS300-8-150	7314150316199	348	80	1	457



NS300-8-200	7314150317769	348	80	1	457
NS300-9-250	7314150317776	348	80	1	457
NS301-10-200	7314150317882	348	80	1	457
NS301-10-300	7314150317899	348	80	1	457
NS301-3-50	7314150317813	348	80	1	457
NS301-4-100	7314150317820	348	80	1	457
NS301-4-150	7314150317837	348	80	1	457
NS301-5-100	7314150317844	348	80	1	457
NS301-5-200	7314150317851	348	80	1	457
NS301-6-100	7314150317868	348	80	1	457
NS301-8-150	7314150317875	348	80	1	457
NS302-0-50	7314150316229	348	80	1	457
NS302-1-100	7314150316236	348	80	1	457
NS302-2-125	7314150316243	348	80	1	457
NS302-3-150	7314150316250	348	80	1	457
NS302-4-300	7314150316267	348	80	1	457
NS304-0-50	7314150316274	348	80	1	457
NS304-1-100	7314150316281	348	80	1	457
NS304-2-125	7314150316298	348	80	1	457
NS304-3-150	7314150316304	348	80	1	457
NS304-4-300	7314150316311	348	80	1	457
NS320-10	7314150318162	348	80	1	458
NS320-2	7314150318087	348	80	1	458
NS320-3	7314150318094	348	80	1	458
NS320-4	7314150318100	348	80	1	458
NS320-5	7314150318117	348	80	1	458
NS320-6	7314150318124	348	80	1	458
NS320-7	7314150318131	348	80	1	458
NS320-8	7314150318148	348	80	1	458
NS320-9	7314150318155	348	80	1	458
NS400-160	7314150316106	348	80	1	458
NS400-180	7314150316113	348	80	1	458
NS400-200	7314150316120	348	80	1	458
NS402-160	7314150316137	348	80	1	458
NS402-200	7314150325177	348	80	1	458
NS403-160	7314150318209	348	80	1	458
NS403-180	7314150318193	348	80	1	458
NS404-160	7314150318216	348	80	1	459
NS405-160	7314150318247	348	80	1	459
NS406-160	7314150316144	348	80	1	459
NS406-180	7314150318261	348	80	1	459
NS406-200	7314150316151	348	80	1	459
NS407-160	7314150318278	348	80	1	459
NS408-250	7314150316168	348	80	1	459
NS408-300	7314150318292	348	80	1	459
NS411-200	7314150318322	348	80	1	459
NS412-200	7314150318339	348	80	1	458
NS413-180	7314150318384	348	80	1	460
NS413-200	7314150318377	348	80	1	460
NS500-1000-FB	7314150296019	348	80	1	461
NS500-1500-FB	7314150296026	348	80	1	461
NS500-2000	7314150291847	348	80	1	460
NS500-2000-FB	7314150284955	348	80	1	461
NS500-2500	7314150291854	348	80	1	460
NS500-2500-FB	7314150284962	348	80	1	461
NS500-3000	7314150291861	348	80	1	460
NS500-3000-FB	7314150284979	348	80	1	461
NS500-3500-FB	7314150284986	348	80	1	461
NS500-4000	7314150291878	348	80	1	460
NS502-1000-FB	7314150284993	348	80	1	460
NS502-10000-FB	7314150285068	348	80	1	460
NS502-12000-FB	7314150318407	348	80	1	460
NS502-1500-FB	7314150318438	348	80	1	460
NS502-2000-FB	7314150285006	348	80	1	460
NS502-2500-FB	7314150285013	348	80	1	460
NS502-3000-FB	7314150285020	348	80	1	460
NS502-450-FB	7314150296033	348	80	1	460
NS502-4500-FB	7314150285037	348	80	1	460
NS502-5000-FB	7314150285044	348	80	1	460
NS502-6800-FB	7314150318445	348	80	1	460
NS502-8000-FB	7314150285051	348	80	1	460
NS504-100-FB	7314150296040	348	80	1	460
NS504-1000-FB	7314150285099	348	80	1	460
NS504-1500-FB	7314150285105	348	80	1	460
NS504-200-FB	7314150296057	348	80	1	460
NS504-2000-FB	7314150285112	348	80	1	460
NS504-300-FB	7314150296064	348	80	1	460
NS504-500-FB	7314150285075	348	80	1	460
NS504-800-FB	7314150285082	348	80	1	460
NS506-300	7314150285129	348	80	1	460
NS506-300-FB	7314150318469	348	80	1	461
NS506-450	7314150285136	348	80	1	460
NS506-450-FB	7314150318476	348	80	1	461
NS506-700	7314150296071	348	80	1	460
NS506-700-FB	7314150285143	348	80	1	461
NS506-900	7314150296088	348	80	1	460
NS506-900-FB	7314150285150	348	80	1	461
NS508-500-FB	731415031				



CUENTA SUBGRUPO



NS600-150-50	7314150296149	348	80	1	462
NS600-180-13	7314150296156	348	80	1	462
NS600-180-32	7314150285167	348	80	1	462
NS600-180-50	7314150285174	348	80	1	462
NS600-200-20	7314150296163	348	80	1	462
NS600-200-30	7314150296170	348	80	1	462
NS600-200-40	7314150296187	348	80	1	462
NS600-200-50	7314150301782	348	80	1	462
NS600-230-40	7314150296194	348	80	1	462
NS600-250-40	7314150296200	348	80	1	462
NS600-300-50	7314150296217	348	80	1	462
NS600-80-13	7314150296095	348	80	1	462
NS602-460	7314150285181	348	80	1	462
NS602-600	7314150285198	348	80	1	462
NS602-760	7314150296224	348	80	1	462
NS602-900	7314150296231	348	80	1	462
NS604-150	7314150296248	348	80	1	462
NS604-200	7314150285204	348	80	1	462
NS604-300	7314150285211	348	80	1	462
NS606-150	7314150285228	348	80	1	462
NS606-200	7314150285235	348	80	1	462
NS606-250	7314150285242	348	80	1	462
NS606-300	7314150285259	348	80	1	462
NS606-400	7314150285266	348	80	1	462
NS608-100	7314150285273	348	80	1	463
NS700-300	7314150325184	348	80	1	463
NS702-200	7314150325191	348	80	1	463
NS704-225	7314150325207	348	80	1	463
NS706-50	7314150325214	348	80	1	464
NS706-80	7314150325221	348	80	1	464
NS708-360	7314150325238	348	80	1	464
NS710-450	7314150325245	348	80	1	464
NS800-1100	7314150296323	348	80	1	464
NS800-1700	7314150285280	348	80	1	464
NS800-2000	7314150296330	348	80	1	464
NS802-290	7314150285297	348	80	1	464
NS804-290	7314150296347	348	80	1	465
NS810-100	7314150318728	348	80	1	465
NS810-150	7314150318711	348	80	1	465
NS810-200	7314150318704	348	80	1	465
NS810-350	7314150318698	348	80	1	465
NSB001-150	7314150292509	348	80	1	448
NSB001-200	7314150284689	348	80	1	448
NSB001-250	7314150284696	348	80	1	448
NSB001-300	7314150284702	348	80	1	448
NSB001-375	7314150292516	348	80	1	448
NSB001-450	7314150292523	348	80	1	448
NSB001-600	7314150292530	348	80	1	448
NSB001-900	7314150292547	348	80	1	448
NSB002-10	7314150316366	348	80	1	448
NSB002-11	7314150316373	348	80	1	448
NSB002-12	7314150316380	348	80	1	448
NSB002-13	7314150316397	348	80	1	448
NSB002-14	7314150316403	348	80	1	448
NSB002-15	7314150316410	348	80	1	448
NSB002-16	7314150316427	348	80	1	448
NSB002-17	7314150316434	348	80	1	448
NSB002-18	7314150316441	348	80	1	448
NSB002-19	7314150316458	348	80	1	448
NSB002-20	7314150316465	348	80	1	448
NSB002-21	7314150316472	348	80	1	448
NSB002-22	7314150316489	348	80	1	448
NSB002-23	7314150316496	348	80	1	448
NSB002-24	7314150316502	348	80	1	448
NSB002-25	7314150316519	348	80	1	448
NSB002-26	7314150316526	348	80	1	448
NSB002-27	7314150316533	348	80	1	448
NSB002-28	7314150316540	348	80	1	448
NSB002-29	7314150316557	348	80	1	448
NSB002-30	7314150316564	348	80	1	448
NSB002-31	7314150321728	348	80	1	448
NSB002-32	7314150316571	348	80	1	448
NSB002-33	7314150321735	348	80	1	448
NSB002-34	7314150321742	348	80	1	448
NSB002-35	7314150321759	348	80	1	448
NSB002-36	7314150321766	348	80	1	448
NSB002-38	7314150321773	348	80	1	448
NSB002-40	7314150321780	348	80	1	448
NSB002-41	7314150321797	348	80	1	448
NSB002-42	7314150321803	348	80	1	448
NSB002-46	7314150321810	348	80	1	448
NSB002-50	7314150321827	348	80	1	448
NSB002-52	7314150321834	348	80	1	448
NSB002-55	7314150321841	348	80	1	448
NSB002-6	7314150316328	348	80	1	448
NSB002-60	7314150321858	348	80	1	448
NSB002-65	7314150321865	348	80	1	448
NSB002-7	7314150316335	348	80	1	448
NSB002-70	7314150321872	348	80	1	448
NSB002-75	7314150321889	348	80	1	448
NSB002-8	7314150316342	348	80	1	448
NSB002-80	7314150321896	348	80	1	448
NSB002-9	7314150316359	348	80	1	448
NSB006-0607	7314150316588	348	80	1	449
NSB006-0608	7314150321926	348	80	1	449
NSB006-0708	7314150321933	348	80	1	449
NSB006-0709	7314150321940	348	80	1	449
NSB006-0809	7314150316595	348	80	1	449



CUENTA SUBGRUPO



NSB006-0810	7314150321957	348	80	1	449
NSB006-0910	7314150321964	348	80	1	449
NSB006-0911	7314150321971	348	80	1	449
NSB006-1011	7314150316601	348	80	1	449
NSB006-1012	7314150322015	348	80	1	449
NSB006-1013	7314150322022	348	80	1	449
NSB006-1014	7314150322039	348	80	1	449
NSB006-1113	7314150322046	348	80	1	449
NSB006-1114	7314150322053	348	80	1	449
NSB006-1213	7314150316618	348	80	1	449
NSB006-1214	7314150322060	348	80	1	449
NSB006-1315	7314150322077	348	80	1	449
NSB006-1415	7314150316625	348	80	1	449
NSB006-1416	7314150322084	348	80	1	449
NSB006-1417	7314150322091	348	80	1	449
NSB006-1617	7314150316632	348	80	1	449
NSB006-1618	7314150322107	348	80	1	449
NSB006-1719	7314150322114	348	80	1	449
NSB006-1722	7314150322121	348	80	1	449
NSB006-1819	7314150316649	348	80	1	449
NSB006-1820	7314150322138	348	80	1	449
NSB006-1920	7314150322145	348	80	1	449
NSB006-1922	7314150322152	348	80	1	449
NSB006-1924	7314150322169	348	80	1	449
NSB006-2022	7314150316656	348	80	1	449
NSB006-2122	7314150322176	348	80	1	449
NSB006-2123	7314150316663	348	80	1	449
NSB006-2223	7314150322183	348	80	1	449
NSB006-2224	7314150322190	348	80	1	449
NSB006-2227	7314150322206	348	80	1	449
NSB006-2326	7314150322213	348	80	1	449
NSB006-2425	7314150322220	348	80	1	449
NSB006-2426	7314150316670	348	80	1	449
NSB006-2427	7314150322237	348	80	1	449
NSB006-2430	7314150322244	348	80	1	449
NSB006-2528	7314150316687	348	80	1	449
NSB006-2629	7314150322251	348	80	1	449
NSB006-2729	7314150316694	348	80	1	449
NSB006-2730	7314150322336	348	80	1	449
NSB006-2732	7314150322343	348	80	1	449
NSB006-2830	7314150322350	348	80	1	449
NSB006-3031	7314150322367	348	80	1	449
NSB006-3032	7314150316700	348	80	1	449
NSB006-3034	7314150322374	348	80	1	449
NSB006-3036	7314150322381	348	80	1	449
NSB006-3234	7314150322398	348	80	1	449
NSB006-3235	7314150322404	348	80	1	449
NSB006-3236	7314150322411	348	80	1	449
NSB006-3335	7314150322428	348	80	1	449
NSB006-3436	7314150322435	348	80	1	449
NSB006-3536	7314150322442	348	80	1	449
NSB006-3638	7314150322459	348	80	1	449
NSB006-3641	7314150322466	348	80	1	449
NSB006-3642	7314150322473	348	80	1	449
NSB006-4146	7314150322480	348	80	1	449
NSB006-4650	7314150322497	348	80	1	449
NSB006-5052	7314150322503	348	80	1	449
NSB006-5055	7314150322510	348	80	1	449
NSB006-5060	7314150322527	348	80	1	449
NSB006-5062	7314150322534	348	80	1	449
NSB006-5560	7314150322558	348	80	1	449
NSB006-6065	7314150322565	348	80	1	449
NSB006-6570	7314150322572	348	80	1	449
NSB010-0607	7314150322589	348	80	1	450
NSB010-0709	7314150322596	348	80	1	450
NSB010-0809	7314150322602	348	80	1	450
NSB010-0911	7314150322619	348	80	1	450
NSB010-1011	7314150322626	348	80	1	450
NSB010-1012	7314150322633	348	80	1	450
NSB010-1214	7314150322640	348	80	1	450
NSB010-1315	7314150322657	348	80	1	450
NSB010-1417	7314150322664	348	80	1	450
NSB010-1618	7314150322671	348	80	1	450
NSB010-1719	7314150322688	348	80	1	450
NSB010-1722	7314150322695	348	80	1	450
NSB010-1819	7314150322718	348	80	1	450
NSB010-1921	7314150322725	348	80	1	450
NSB010-1922	7314150322732	348	80	1	450
NSB010-2022	7314150322749	348	80	1	450
NSB010-2123	7314150322766	348	80	1	450
NSB010-2224	7314150322763	348	80	1	450
NSB010-2427	7314150322770	348	80	1	450
NSB010-2528	7314150322787	348	80		

NSB011-1819



NSB	CUENTA	SUBGRUPO			
NSB011-1819	7314150317462	348	80	1	450
NSB011-2022	7314150317479	348	80	1	450
NSB011-2123	7314150317486	348	80	1	450
NSB011-2426	7314150317493	348	80	1	450
NSB011-2528	7314150317509	348	80	1	450
NSB011-2729	7314150317516	348	80	1	450
NSB011-3032	7314150317523	348	80	1	450
NSB100-100	7314150323302	348	80	1	451
NSB100-105	7314150323319	348	80	1	451
NSB100-110	7314150323326	348	80	1	451
NSB100-115	7314150323333	348	80	1	451
NSB100-120	7314150323340	348	80	1	451
NSB100-17	7314150322886	348	80	1	450
NSB100-19	7314150322893	348	80	1	450
NSB100-22	7314150322909	348	80	1	450
NSB100-24	7314150322916	348	80	1	450
NSB100-25	7314150322923	348	80	1	450
NSB100-27	7314150322930	348	80	1	450
NSB100-28	7314150322947	348	80	1	450
NSB100-29	7314150322954	348	80	1	450
NSB100-30	7314150322961	348	80	1	450
NSB100-32	7314150322978	348	80	1	450
NSB100-33	7314150322985	348	80	1	450
NSB100-34	7314150322992	348	80	1	450
NSB100-35	7314150323005	348	80	1	450
NSB100-36	7314150323012	348	80	1	450
NSB100-37	7314150323029	348	80	1	450
NSB100-38	7314150323036	348	80	1	450
NSB100-41	7314150323043	348	80	1	450
NSB100-42	7314150323050	348	80	1	450
NSB100-45	7314150323067	348	80	1	450
NSB100-46	7314150323074	348	80	1	450
NSB100-47	7314150323081	348	80	1	450
NSB100-50	7314150323098	348	80	1	450
NSB100-52	7314150323104	348	80	1	450
NSB100-54	7314150323111	348	80	1	450
NSB100-55	7314150323128	348	80	1	450
NSB100-56	7314150323135	348	80	1	450
NSB100-58	7314150323142	348	80	1	450
NSB100-60	7314150323159	348	80	1	450
NSB100-63	7314150323166	348	80	1	451
NSB100-65	7314150323173	348	80	1	451
NSB100-67	7314150323180	348	80	1	451
NSB100-70	7314150323197	348	80	1	451
NSB100-71	7314150323203	348	80	1	451
NSB100-75	7314150323210	348	80	1	451
NSB100-77	7314150323227	348	80	1	451
NSB100-80	7314150323234	348	80	1	451
NSB100-82	7314150323241	348	80	1	451
NSB100-85	7314150323258	348	80	1	451
NSB100-88	7314150323265	348	80	1	451
NSB100-90	7314150323272	348	80	1	451
NSB100-94	7314150323289	348	80	1	451
NSB100-95	7314150323296	348	80	1	451
NSB104-100	7314150316885	348	80	1	451
NSB104-105	7314150316892	348	80	1	451
NSB104-110	7314150316908	348	80	1	451
NSB104-115	7314150323937	348	80	1	451
NSB104-120	7314150316915	348	80	1	451
NSB104-17	7314150323357	348	80	1	451
NSB104-19	7314150323364	348	80	1	451
NSB104-20	7314150323371	348	80	1	451
NSB104-22	7314150323388	348	80	1	451
NSB104-24	7314150316717	348	80	1	451
NSB104-25	7314150323395	348	80	1	451
NSB104-26	7314150323401	348	80	1	451
NSB104-27	7314150316724	348	80	1	451
NSB104-28	7314150323418	348	80	1	451
NSB104-29	7314150323425	348	80	1	451
NSB104-30	7314150316731	348	80	1	451
NSB104-31	7314150323432	348	80	1	451
NSB104-32	7314150316748	348	80	1	451
NSB104-33	7314150323449	348	80	1	451
NSB104-34	7314150323456	348	80	1	451
NSB104-35	7314150323463	348	80	1	451
NSB104-36	7314150316755	348	80	1	451
NSB104-37	7314150323470	348	80	1	451
NSB104-38	7314150323487	348	80	1	451
NSB104-39	7314150323494	348	80	1	451
NSB104-40	7314150323500	348	80	1	451
NSB104-41	7314150316762	348	80	1	451
NSB104-42	7314150323517	348	80	1	451
NSB104-43	7314150323524	348	80	1	451
NSB104-44	7314150323531	348	80	1	451
NSB104-45	7314150323548	348	80	1	451
NSB104-46	7314150316779	348	80	1	451
NSB104-47	7314150323555	348	80	1	451
NSB104-48	7314150323562	348	80	1	451
NSB104-49	7314150323579	348	80	1	451
NSB104-50	7314150316786	348	80	1	451
NSB104-51	7314150323586	348	80	1	451
NSB104-52	7314150323593	348	80	1	451
NSB104-53	7314150323609	348	80	1	451
NSB104-54	7314150323616	348	80	1	451
NSB104-55	7314150316793	348	80	1	451
NSB104-56	7314150323623	348	80	1	451
NSB104-57	7314150323630	348	80	1	451
NSB104-58	7314150323647	348	80	1	451



NSB	CUENTA	SUBGRUPO			
NSB104-59	7314150323654	348	80	1	451
NSB104-60	7314150316809	348	80	1	451
NSB104-61	7314150323661	348	80	1	451
NSB104-62	7314150323678	348	80	1	451
NSB104-63	7314150323685	348	80	1	451
NSB104-64	7314150323692	348	80	1	451
NSB104-65	7314150316816	348	80	1	451
NSB104-66	7314150323708	348	80	1	451
NSB104-67	7314150323715	348	80	1	451
NSB104-68	7314150323722	348	80	1	451
NSB104-69	7314150323739	348	80	1	451
NSB104-70	7314150316823	348	80	1	451
NSB104-71	7314150323746	348	80	1	451
NSB104-72	7314150323753	348	80	1	451
NSB104-73	7314150323760	348	80	1	451
NSB104-74	7314150323777	348	80	1	451
NSB104-75	7314150316830	348	80	1	451
NSB104-76	7314150323784	348	80	1	451
NSB104-77	7314150323791	348	80	1	451
NSB104-78	7314150323807	348	80	1	451
NSB104-79	7314150323814	348	80	1	451
NSB104-80	7314150316847	348	80	1	451
NSB104-81	7314150323821	348	80	1	451
NSB104-82	7314150323838	348	80	1	451
NSB104-83	7314150323845	348	80	1	451
NSB104-84	7314150323852	348	80	1	451
NSB104-85	7314150316854	348	80	1	451
NSB104-86	7314150323869	348	80	1	451
NSB104-87	7314150323876	348	80	1	451
NSB104-88	7314150323883	348	80	1	451
NSB104-89	7314150323890	348	80	1	451
NSB104-90	7314150316861	348	80	1	451
NSB104-92	7314150323906	348	80	1	451
NSB104-94	7314150323913	348	80	1	451
NSB104-95	7314150316878	348	80	1	451
NSB104-98	7314150323920	348	80	1	451
NSB106-100	7314150324361	348	80	1	452
NSB106-104	7314150324378	348	80	1	452
NSB106-108	7314150324385	348	80	1	452
NSB106-112	7314150324392	348	80	1	452
NSB106-114	7314150324408	348	80	1	452
NSB106-116	7314150324415	348	80	1	452
NSB106-120	7314150324422	348	80	1	452
NSB106-124	7314150324439	348	80	1	452
NSB106-126	7314150324446	348	80	1	452
NSB106-128	7314150324453	348	80	1	452
NSB106-132	7314150324460	348	80	1	452
NSB106-136	7314150324477	348	80	1	452
NSB106-138	7314150324484	348	80	1	452
NSB106-144	7314150324491	348	80	1	452
NSB106-146	7314150324507	348	80	1	452
NSB106-150	7314150324514	348	80	1	452
NSB106-156	7314150324521	348	80	1	452
NSB106-158	7314150324538	348	80	1	452
NSB106-20	7314150323944	348	80	1	452
NSB106-22	7314150323951	348	80	1	452
NSB106-24	7314150323968	348	80	1	452
NSB106-25	7314150323975	348	80	1	452
NSB106-26	7314150323982	348	80	1	452
NSB106-28	7314150323999	348	80	1	452
NSB106-30	7314150324002	348	80	1	452
NSB106-32	7314150324019	348	80	1	452
NSB106-34	7314150324026	348	80	1	452
NSB106-36	7314150324033	348	80	1	452
NSB106-38	7314150324040	348	80	1	452
NSB106-40	7314150324057	348	80	1	452
NSB106-42	7314150324064	348	80	1	452
NSB106-44	7314150324071	348	80	1	452
NSB106-45	7314150324088	348	80	1	452
NSB106-46	7314150324095	348	80	1	452
NSB106-48	7314150324101	348	80	1	452
NSB106-50	7314150324118	348	80	1	452
NSB106-52	7314150324125	348	80	1	452
NSB106-54	7314150324132	348	80	1	452
NSB106-56	7314150324149	348	80	1	452
NSB106-58	7314150324156	348	80	1	452
NSB106-60	7314150324163	348	80	1	452
NSB106-62	7314150324170	348	80	1	452
NSB106-64	7314150324187	348	80	1	452
NSB106-66	7314150324194	348	80	1	452
NSB106-68	7314150324200	348	80	1	452
NSB106-70	7314150324217	348	80	1	452
NSB106-71	7314150324224	348	80	1	452
NSB106-72	7314150324231	348	80	1	452
NSB106-74	7314150324248	348	80	1	452
NSB106-76	7314150324255	348	80	1	452
NSB106-78	7314150324262	348	80	1	



CUENTA SUBGRUPO



NSB200-250	7314150324552	348	80	1	452
NSB200-300	7314150324569	348	80	1	452
NSB200-350	7314150324576	348	80	1	452
NSB200-450	7314150324583	348	80	1	452
NSB200-600	7314150324590	348	80	1	452
NSB200-900	7314150324606	348	80	1	452
NSB202-350	7314150324620	348	80	1	453
NSB203-200	7314150359561	348	80	1	453
NSB203-215	7314150359578	348	80	1	453
NSB203-290	7314150359585	348	80	1	453
NSB203-400	7314150359592	348	80	1	453
NSB203-490	7314150359608	348	80	1	453
NSB203-800	7314150359615	348	80	1	453
NSB204-30	7314150324637	348	80	1	453
NSB204-32	7314150324644	348	80	1	453
NSB204-35	7314150324651	348	80	1	453
NSB204-40	7314150324668	348	80	1	453
NSB204-45	7314150324675	348	80	1	453
NSB204-48	7314150324682	348	80	1	453
NSB204-50	7314150324699	348	80	1	453
NSB204-55	7314150324705	348	80	1	453
NSB204-60	7314150324712	348	80	1	453
NSB204-65	7314150324729	348	80	1	453
NSB204-70	7314150324736	348	80	1	453
NSB204-75	7314150324743	348	80	1	453
NSB204-80	7314150324750	348	80	1	453
NSB204-85	7314150324767	348	80	1	453
NSB204-90	7314150324774	348	80	1	453
NSB220-06	7314150354023	348	80	1	454
NSB220-07	7314150354030	348	80	1	454
NSB220-08	7314150354047	348	80	1	454
NSB220-09	7314150354054	348	80	1	454
NSB220-10	7314150354061	348	80	1	454
NSB220-11	7314150354078	348	80	1	454
NSB220-12	7314150354085	348	80	1	454
NSB220-13	7314150354092	348	80	1	454
NSB220-14	7314150354108	348	80	1	454
NSB220-15	7314150354115	348	80	1	454
NSB220-16	7314150354122	348	80	1	454
NSB220-17	7314150354139	348	80	1	454
NSB220-18	7314150354146	348	80	1	454
NSB220-19	7314150354153	348	80	1	454
NSB220-20	7314150354160	348	80	1	454
NSB220-21	7314150354177	348	80	1	454
NSB220-22	7314150354184	348	80	1	454
NSB220-23	7314150354191	348	80	1	454
NSB220-24	7314150354207	348	80	1	454
NSB220-25	7314150354214	348	80	1	454
NSB220-26	7314150354221	348	80	1	454
NSB220-27	7314150354238	348	80	1	454
NSB220-28	7314150354245	348	80	1	454
NSB220-29	7314150354252	348	80	1	454
NSB220-30	7314150354269	348	80	1	454
NSB220-32	7314150354276	348	80	1	454
NSB224-17	7314150355723	348	80	1	454
NSB224-18	7314150355730	348	80	1	454
NSB224-19	7314150355747	348	80	1	454
NSB224-21	7314150355754	348	80	1	454
NSB224-22	7314150355761	348	80	1	454
NSB224-23	7314150355778	348	80	1	454
NSB224-24	7314150355785	348	80	1	454
NSB224-26	7314150355792	348	80	1	454
NSB224-27	7314150355808	348	80	1	454
NSB224-28	7314150355815	348	80	1	454
NSB224-29	7314150355822	348	80	1	454
NSB224-30	7314150355839	348	80	1	454
NSB224-32	7314150355846	348	80	1	454
NSB224-34	7314150355853	348	80	1	454
NSB224-36	7314150355860	348	80	1	454
NSB224-38	7314150355877	348	80	1	454
NSB224-41	7314150355884	348	80	1	454
NSB224-46	7314150355891	348	80	1	454
NSB224-50	7314150355907	348	80	1	454
NSB228-22	7314150356126	348	80	1	454
NSB228-24	7314150356133	348	80	1	454
NSB228-26	7314150356140	348	80	1	454
NSB228-27	7314150356157	348	80	1	454
NSB228-28	7314150356164	348	80	1	454
NSB228-29	7314150356171	348	80	1	454
NSB228-30	7314150356188	348	80	1	454
NSB228-31	7314150356195	348	80	1	454
NSB228-32	7314150356201	348	80	1	454
NSB228-34	7314150356218	348	80	1	454
NSB228-36	7314150356225	348	80	1	454
NSB228-38	7314150356232	348	80	1	454
NSB228-41	7314150356249	348	80	1	454
NSB228-46	7314150356256	348	80	1	454
NSB228-50	7314150356263	348	80	1	454
NSB228-55	7314150356270	348	80	1	454
NSB228-60	7314150356287	348	80	1	454
NSB228-65	7314150356294	348	80	1	454
NSB228-70	7314150356300	348	80	1	454
NSB228-75	7314150356317	348	80	1	454
NSB228-80	7314150356324	348	80	1	454
NSB232-16-24	7314150356379	348	80	1	455
NSB232-24-16	7314150356393	348	80	1	455
NSB232-24-32	7314150356386	348	80	1	455
NSB232-32-24	7314150356409	348	80	1	455



CUENTA SUBGRUPO



NSB234-16-100	7314150356461	348	80	1	455
NSB234-16-200	7314150356478	348	80	1	455
NSB234-16-250	7314150356485	348	80	1	455
NSB234-24-200	7314150356492	348	80	1	455
NSB234-32-250	7314150356508	348	80	1	455
NSB236-16	7314150356553	348	80	1	455
NSB236-24	7314150356546	348	80	1	455
NSB236-32	7314150356560	348	80	1	455
NSB238-16-250	7314150356621	348	80	1	455
NSB238-24-250	7314150356614	348	80	1	455
NSB238-32-300	7314150356607	348	80	1	455
NSB240-16-230	7314150356744	348	80	1	456
NSB242-16	7314150356669	348	80	1	456
NSB242-24	7314150356676	348	80	1	456
NSB242-32	7314150356683	348	80	1	456
NSB243-16-400	7314150356706	348	80	1	456
NSB247-26	7314150356768	348	80	1	456
NSB248-16-52	7314150356720	348	80	1	456
NSB300-10-200	7314150317646	348	80	1	457
NSB300-10-300	7314150295845	348	80	1	457
NSB300-11-250	7314150317653	348	80	1	457
NSB300-11-300	7314150317660	348	80	1	457
NSB300-11-350	7314150295852	348	80	1	457
NSB300-12-400	7314150295869	348	80	1	457
NSB300-13-450	7314150295876	348	80	1	457
NSB300-3-50	7314150317530	348	80	1	457
NSB300-3-75	7314150317547	348	80	1	457
NSB300-4-75	7314150317554	348	80	1	457
NSB300-4.5-100	7314150295838	348	80	1	457
NSB300-4.5-50	7314150317561	348	80	1	457
NSB300-5-100	7314150317585	348	80	1	457
NSB300-5-75	7314150317578	348	80	1	457
NSB300-6-100	7314150285327	348	80	1	457
NSB300-6-125	7314150317592	348	80	1	457
NSB300-6-150	7314150317608	348	80	1	457
NSB300-7-150	7314150317615	348	80	1	457
NSB300-8-150	7314150285334	348	80	1	457
NSB300-8-200	7314150317622	348	80	1	457
NSB300-9-250	7314150317639	348	80	1	457
NSB301-10-200	7314150317974	348	80	1	457
NSB301-10-300	7314150317981	348	80	1	457
NSB301-3-50	7314150317905	348	80	1	457
NSB301-4-100	7314150317912	348	80	1	457
NSB301-4-150	7314150317929	348	80	1	457
NSB301-5-100	7314150317936	348	80	1	457
NSB301-5-200	7314150317943	348	80	1	457
NSB301-6-100	7314150317950	348	80	1	457
NSB301-8-150	7314150317967	348	80	1	457
NSB302-0-50	7314150295883	348	80	1	457
NSB302-1-100	7314150285341	348	80	1	457
NSB302-2-125	7314150285358	348	80	1	457
NSB302-3-150	7314150295890	348	80	1	457
NSB302-4-300	7314150295906	348	80	1	457
NSB304-0-50	7314150295913	348	80	1	458
NSB304-1-100	7314150295920	348	80	1	458
NSB304-2-125	7314150295937	348	80	1	458
NSB304-3-150	7314150295944	348	80	1	458
NSB304-4-300	7314150295951	348	80	1	458
NSB320-10	7314150318070	348	80	1	458
NSB320-2	7314150317998	348	80	1	458
NSB320-3	7314150318001	348	80	1	458
NSB320-4	7314150318018	348	80	1	458
NSB320-5	7314150318025	348	80	1	458
NSB320-6	7314150318032	348	80	1	458
NSB320-7	7314150318049	348	80	1	458
NSB320-8	7314150318056	348	80	1	458
NSB320-9	7314150318063	348	80	1	458
NSB400-160	7314150295968	348	80	1	458
NSB400-180	7314150285365	348	80	1	458
NSB400-200	7314150295975	348	80	1	458
NSB402-160	7314150295982	348	80	1	458
NSB402-200	7314150285372	348	80	1	458
NSB403-160	7314150318179	348	80	1	459
NSB403-180	7314150318186	348	80	1	459
NSB404-160	7314150318223	348	80	1	459
NSB405-160	7314150318230	348	80	1	459
NSB406-160	7314150295999	348	80	1	459
NSB406-180	7314150318254	348	80	1	459
NSB406-200	7314150296002	348	80	1	459
NSB407-160	7314150318285	348	80	1	459
NSB408-250	7314150285389	348	80	1	459
NSB408-300	7314150318308	348	80	1	

NSB502-12000-FB



NSB502-12000-FB	7314150318414	348	80	1	461
NSB502-1500-FB	7314150318421	348	80	1	461
NSB502-2000-FB	7314150316939	348	80	1	461
NSB502-2500-FB	7314150316946	348	80	1	461
NSB502-3000-FB	7314150316953	348	80	1	461
NSB502-450-FB	7314150324880	348	80	1	461
NSB502-4500-FB	7314150316960	348	80	1	461
NSB502-5000-FB	7314150316977	348	80	1	461
NSB502-6800-FB	7314150318452	348	80	1	461
NSB502-8000-FB	7314150316984	348	80	1	461
NSB504-100-FB	7314150317004	348	80	1	461
NSB504-1000-FB	7314150317059	348	80	1	461
NSB504-1500-FB	7314150317066	348	80	1	461
NSB504-200-FB	7314150317011	348	80	1	461
NSB504-2000-FB	7314150317073	348	80	1	461
NSB504-300-FB	7314150317028	348	80	1	461
NSB504-500-FB	7314150317035	348	80	1	461
NSB504-800-FB	7314150317042	348	80	1	461
NSB506-300	7314150324897	348	80	1	461
NSB506-300-FB	7314150318490	348	80	1	462
NSB506-450	7314150324903	348	80	1	461
NSB506-450-FB	7314150318483	348	80	1	462
NSB506-700	7314150324910	348	80	1	461
NSB506-700-FB	7314150317080	348	80	1	462
NSB506-900	7314150324927	348	80	1	461
NSB506-900-FB	7314150317097	348	80	1	462
NSB508-500-FB	7314150318513	348	80	1	461
NSB508-700-FB	7314150318520	348	80	1	461
NSB512-200-FB	7314150318643	348	80	1	461
NSB512-400-FB	7314150318636	348	80	1	461
NSB512-600-FB	7314150318629	348	80	1	461
NSB512-900-FB	7314150318605	348	80	1	461
NSB600-100-50	7314150317110	348	80	1	462
NSB600-135-50	7314150317127	348	80	1	462
NSB600-150-25	7314150317134	348	80	1	462
NSB600-150-30	7314150317141	348	80	1	462
NSB600-150-40	7314150317158	348	80	1	462
NSB600-150-50	7314150317165	348	80	1	462
NSB600-180-13	7314150317172	348	80	1	462
NSB600-180-32	7314150317189	348	80	1	462
NSB600-180-50	7314150317196	348	80	1	462
NSB600-200-20	7314150317202	348	80	1	462
NSB600-200-30	7314150317219	348	80	1	462
NSB600-200-40	7314150317226	348	80	1	462
NSB600-200-50	7314150317233	348	80	1	462
NSB600-230-40	7314150317240	348	80	1	462
NSB600-250-40	7314150317257	348	80	1	462
NSB600-300-50	7314150317264	348	80	1	462
NSB600-80-13	7314150317103	348	80	1	462
NSB602-460	7314150324934	348	80	1	462
NSB602-600	7314150324941	348	80	1	462
NSB602-760	7314150324958	348	80	1	462
NSB602-900	7314150324965	348	80	1	462
NSB604-150	7314150324972	348	80	1	462
NSB604-200	7314150324989	348	80	1	462
NSB604-300	7314150324996	348	80	1	462
NSB606-150	7314150325009	348	80	1	463
NSB606-200	7314150325016	348	80	1	463
NSB606-250	7314150325023	348	80	1	463
NSB606-300	7314150325030	348	80	1	463
NSB606-400	7314150325047	348	80	1	463
NSB608-100	7314150325054	348	80	1	463
NSB700-300	7314150296255	348	80	1	463
NSB702-200	7314150296262	348	80	1	463
NSB704-225	7314150296279	348	80	1	463
NSB706-50	7314150296286	348	80	1	464
NSB706-80	7314150296293	348	80	1	464
NSB708-360	7314150296309	348	80	1	464
NSB710-450	7314150296316	348	80	1	464
NSB800-1100	7314150325061	348	80	1	464
NSB800-1700	7314150325078	348	80	1	464
NSB800-2000	7314150325085	348	80	1	464
NSB802-290	7314150325092	348	80	1	465
NSB810-100	7314150318650	348	80	1	465
NSB810-150	7314150318667	348	80	1	465
NSB810-200	7314150318674	348	80	1	465
NSB810-350	7314150318681	348	80	1	465
P-HB	7314150125272	336	10	25	487
P-MEC	7314150374342	336	10	24	487
P-MEC-LEAD	7314150374359	336	10	12	487
P1-20	7311518044572	352	10	5	558
P1-23	7311518332501	352	10	5	558
P108-20-F	7311518275518	352	10	2	558
P108-23-F	7311518275525	352	10	2	558
P11	7311518009076	334	13	6	566
P110-20-F	7311518275532	352	10	2	557
P110-23-F	7311518275549	352	10	2	557
P114-SL-40	7311518301149	352	15	2	560
P114-SL-50	7311518301156	352	15	2	560
P114-SL-60	7311518301163	352	15	2	560
P116-SL-40	7311518301101	352	15	2	561
P116-SL-50	7311518301118	352	15	2	561
P116-SL-60	7311518301125	352	15	2	561
P116-SL-70	7311518301132	352	15	2	561
P121-18-F	7311518275662	352	10	6	557
P121-20-F	7311518275631	352	10	6	557
P121-23-F	7311518275648	352	10	6	557
P123-19-BULK15	7311518226251	352	10	15	560



P123-19-BULK30	7311518218218	352	10	30	560
P123-19-BULK56	7311518240202	352	10	56	560
P126-19-F	7311518275297	352	10	6	557
P126-22-F	7311518275303	352	10	6	557
P127-19-BULK30	7311518199333	352	10	30	560
P128-19	7311518160814	352	10	6	560
P128-19-BULK30	7311518172329	352	10	30	560
P129-19-BULK30	7311518172336	352	10	30	560
P130-F	7311518333980	352	15	6	561
P138-22-F	7311518301279	352	10	6	558
P140-F	7311518275372	352	15	6	561
P16-40	7311518013479	352	15	2	560
P16-40W	7311518043049	352	15	2	560
P16-50-F	7311518301286	352	15	2	560
P16-60-F	7311518276461	352	15	2	560
P160-SL-60	7311518301170	352	15	2	561
P160-SL-75	7311518301187	352	15	1	561
P160-SL-90	7311518301194	352	15	1	561
P173-SL-85	7311518334703	352	15	1	561
P19-80-F	7311518275365	352	15	1	561
P20	7311518009281	334	13	6	566
P241	7311518008956	320	10	5	554
P262	7311518299286	320	10	10	553
P263	7311518299262	320	10	10	553
P264	7311518299279	320	10	10	553
P266	7311518299293	320	10	10	553
P267	7311518299309	320	10	10	553
P268	7311518299316	320	10	10	553
P269	7311518299323	320	10	10	554
P270	7311518299330	320	10	10	554
P272	7311518299354	320	10	5	553
P274	7311518299347	320	10	5	553
P276	7311518299361	320	10	5	553
P277	7311518299378	320	10	5	553
P278	7311518299385	320	10	5	553
P280-SL-80	7311518301330	352	15	2	561
P3-20-F	7311518275259	352	10	2	557
P3-23-F	7311518275266	352	10	2	557
P34-27A-F	7311518275464	352	30	2	563
P34-37	7311518002787	352	30	2	562
P39-22	7311518337988	352	10	2	558
P5-20-F	7311518275273	352	10	2	558
P5-23-F	7311518275280	352	10	2	558
P51-F	7311518275426	352	20	2	565
P51-SL	7311518301217	352	20	2	565
P51H-SL	7311518301224	352	20	2	565
P54-SL-20	7311518301248	352	20	2	566
P54-SL-25	7311518301231	352	20	2	566
P54H-SL-20	7311518301262	352	20	2	566
P54H-SL-25	7311518301255	352	20	2	566
P57-25-F	7311518301293	352	20	4	565
P57-25-W-F	7311518301309	352	20	4	565
P59-25-F	7311518275655	352	20	6	566
P6160	7314150115075	340	65	10	578
P64-20	7311518288174	352	10	6	558
P64-20-BULK12	7311518288204	352	10	12	558
P74	7311518124076	352	25	1	566
P75	7311518124083	352	25	1	566
PAGS-2.0	7311518327835	320	20	6	539
PAGS-2.0-900FG	7311518292355	320	20	1	539
PBB-8	7314150399376	336	10	6	486
PBS-700	7314150341689	336	10	6	486
PC-10-DTF	7311518263560	330	10	10	506
PC-10-DTL	7311518263553	330	10	10	506
PC-10-DTR	7311518263546	330	10	10	506
PC-11-19-PS	7311518285548	330	10	4	506
PC-11-19-PS-B	7311518285555	330	10	10	506
PC-12-14-PS	7311518285562	330	10	4	506
PC-12-14-PS-B	7311518285579	330	10	10	506
PC-12-COM	7311518263454	330	10	4	502
PC-12-TEN	7311518263447	330	10	4	505
PC-12-VEN	7311518263430	330	10	4	505
PC-15-GNP	7311518264307	330	10	4	502
PC-15-TBX	7311518263423	330	10	4	505
PC-16-DECO	7311518264987	330	10	4	502
PC-16-FILE-U7	7311518263461	330	10	4	503
PC-19-FILE-U7	7311518263478	330	10	4	503
PC-19-GT7	7311518263362	330	10	4	503
PC-19-GT9	7311518263379	330	10	4	505
PC-20-LAM	7311518258290	330	10	4	504
PC-20-PRC	7311518264291	330	10	4	505
PC-22-FILE-U7	7311518263485	330	10	4	503
PC-22-GT7	7311518263393	330	10	4	503
PC-22-GT9	7311518263409	330	10	4	505
PC-22-INS	7314150154500	330	10	4	503
PC-22-PLC	7314150276318	330	10	4	502
PC-24-FILE-U7	7311518263492	330	10	4	503
PC-24-PLS	7311518263508	330	10	4	502
PC-24-TIM	7311518263515	330	10	4	505
PC-6-DRY					



CUENTA SUBGRUPO



PG-18-60-F	7311518288853	352	15	2	561
PG-19-F	7311518295936	352	15	2	561
PG-56-F	7311518288938	352	20	2	566
PG-57-F	7311518295943	352	20	2	566
PG-72	7311518242534	330	20	4	568
PG-L2-F	7311518269746	352	10	2	557
PG-M2-F	7311518269715	352	10	2	557
PG-R-M2-F	7311518269722	352	10	2	557
PG-S1-F	7311518327743	352	10	2	557
PH-6604-1P	7311518152819	324	10	15	35
PH-6604-25	7311518141134	324	10	25	35
PROF-H	7311518158439	356	30	2	571
PROF-LOPP	7311518288549	356	30	1	571
PROF-SEC	7311518288532	356	30	1	571
PS501-1	7314150338283	360	25	1	589
PS501-2	7314150112432	360	25	1	589
PS501-3	7314150338290	360	25	1	589
PS501-4	7314150338306	360	25	1	589
PU-10	7314150016181	366	10	5	44
PU-11	7314150016204	366	10	5	44
PU-12	7314150016228	366	10	5	44
PU-13	7314150016242	366	10	5	44
PU-14	7314150016266	366	10	5	44
PU-15	7314150016280	366	10	5	44
PU-16	7314150016303	366	10	5	44
PU-17	7314150016327	366	10	5	44
PU-18	7314150016341	366	10	5	44
PU-19	7314150016365	366	10	5	44
PU-20	7314150016389	366	10	3	44
PU-21	7314150016402	366	10	3	44
PU-22	7314150016426	366	10	3	44
PU-23	7314150016440	366	10	3	44
PU-24	7314150016464	366	10	3	44
PU-25	7314150016488	366	10	1	44
PU-26	7314150016501	366	10	1	44
PU-27	7314150016525	366	10	1	44
PU-28	7314150016549	366	10	1	44
PU-29	7314150016563	366	10	1	44
PU-30	7314150016587	366	10	1	44
PU-32	7314150016600	366	10	1	44
PU-36	7314150016631	366	10	1	44
PU-42	7314151839369	366	10	1	44
PU-6	7314150016105	366	10	5	44
PU-7	7314150016129	366	10	5	44
PU-8	7314150016143	366	10	5	44
PU-9	7314150016167	366	10	5	44
PX-L2	7311518233853	352	10	2	556
PX-L3	7311518233860	352	10	2	556
PX-M1	7311518233815	352	10	2	556
PX-M2	7311518233822	352	10	2	556
PX-M2-L	7311518240714	352	10	2	556
PX-M3	7311518233839	352	10	2	556
PX-S1	7311518233785	352	10	2	556
PX-S2	7311518233792	352	10	2	556
PXR-L1	7311518233907	352	10	2	556
PXR-L2	7311518233914	352	10	2	556
PXR-M1	7311518233877	352	10	2	556
PXR-M2	7311518233884	352	10	2	556
PXR-M2-L	7311518240738	352	10	2	556
PXR-M3	7311518233891	352	10	2	556
PXR-S1	7311518240677	352	10	2	556
PXR-S2	7311518240684	352	10	2	556
QC-300A	7314150401925	318	10	6	526
QCB-1250	7314150135981	318	10	8	526
QCB-150	7314150135912	318	10	6	526
QCB-300	7314150135936	318	10	6	526
QCB-450	7314150135950	318	10	6	526
QCB-600	7314150135967	318	10	4	526
QCB-900	7314150135974	318	10	4	526
QCG-150	7314150135899	318	10	6	526
QCG-300	7314150135905	318	10	6	526
R1068	7311518044398	352	10	1	559
R1069P	7311518219574	352	10	12	559
R1071	7311518222918	352	10	14	560
R1075-BULK50	7311518220495	352	10	50	560
R1080P	7311518282479	352	10	1	559
R112PG	7311518010058	352	10	1	558
R113PG	7311518044374	352	10	30	559
R114PG	7311518010065	352	10	1	558
R114V	7311518042660	352	15	25	562
R114V-BULK28	7311518177539	352	15	28	562
R115V	7311518243210	352	15	8	562
R115V-BULK14	7311518288341	352	15	14	562
R116V	7311518010164	352	15	1	562
R116V-BULK36	7311518159924	352	15	36	562
R116VP	7311518042721	352	15	25	562
R119V	7311518029487	352	15	1	562
R122PG	7311518010072	352	10	30	558
R123PG	7311518044381	352	10	30	559
R124PG	7311518010089	352	10	30	558
R1269P-BULK50	7311518240820	352	10	50	556
R133PG	7311518328252	352	30	1	565
R142P	7311518010126	352	10	24	559
R143PV	7311518010133	352	15	1	562
R143PVCB	7311518255633	352	15	1	562
R144PV	7311518291075	352	15	24	562
R146VC	7311518046545	352	20	22	566
R146VS	7311518046538	352	15	24	562



CUENTA SUBGRUPO



R146VS-BULK50	7311518159955	352	15	50	562
R147V	7311518044909	352	20	24	566
R1601	7311518044640	352	10	1	559
R160A	7311518201821	352	15	1	562
R166V	7311518328085	352	15	22	562
R16V	7311518254513	352	15	1	562
R16V-BULK14	7311518288334	352	15	14	562
R171P	7311518226534	352	10	1	558
R172A	7311518235413	352	15	1	562
R180V	7311518042677	352	15	20	562
R181P	7311518296087	352	15	1	562
R2000AP	7311518301088	352	30	8	564
R201P	7311518219536	352	10	1	558
R201P-BULK80	7311518225209	352	10	80	558
R202P	7311518219550	352	10	1	559
R211P	7311518234027	352	10	1	556
R211P-BULK80	7311518252212	352	10	80	556
R214SL	7311518301392	352	15	1	562
R214V	7311518042745	352	15	1	562
R214V-BULK28	7311518177553	352	15	28	562
R215V	7311518243227	352	15	1	562
R216SL	7311518301408	352	15	8	562
R221P	7311518229412	352	10	1	558
R221P-BULK50	7311518240653	352	10	50	558
R223P	7311518237554	352	10	1	558
R223P-BULK80	7311518240646	352	10	80	558
R239P	7311518219567	352	10	1	559
R260A	7311518201814	352	15	16	562
R272H	7311518258016	352	15	1	562
R300P	7311518234034	352	10	1	556
R303P	7311518234157	352	10	1	556
R310-0	7314151829797	366	15	1	57
R310-1	7314151829803	366	15	1	57
R310-2	7314151829810	366	15	1	57
R310-3	7314151829827	366	15	1	57
R312V	7311518235420	352	15	1	562
R315V	7311518243234	352	15	1	562
R318V	7311518029500	352	15	1	562
R328V	7311518296056	352	15	22	562
R337E	7311518011598	352	30	1	565
R341P	7311518011529	352	10	12	559
R372H	7311518235406	352	15	1	562
R373A	7311518334710	352	15	25	562
R403P	7311518234164	352	10	1	556
R414V-BULK10	7311518334567	352	15	10	562
R415V	7311518243241	352	15	1	562
R419V	7311518042936	352	15	1	562
R427AE	7311518176068	352	30	18	565
R430V	7311518243265	352	15	1	562
R437E	7311518011611	352	30	18	565
R438P	7311518229429	352	10	1	559
R438P-BULK50	7311518240660	352	10	50	559
R440V	7311518254544	352	15	22	562
R444V	7311518243340	352	20	22	566
R463P	7311518223908	352	10	1	559
R474P	7311518011536	352	10	1	559
R478P	7311518275600	352	10	1	560
R480P	7311518282486	352	10	1	560
R500P	7311518234041	352	10	40	556
R503P	7311518234171	352	10	1	556
R515VS	7311518046514	352	15	22	566
R516V	7311518200824	352	15	22	566
R519V	7311518029517	352	15	1	562
R600P	7311518240783	352	10	1	556
R603P	7311518240790	352	10	1	556
R615V	7311518010119	352	15	1	562
R619V	7311518029494	352	15	1	562
R660V	7311518210281	352	15	24	562
R6725MK	7314151088354	354	25	1	73
R6725ZK	7314151784898	354	25	1	73
R680V	7311518042752	352	15	1	562
R6950	7314151089658	354	20	1	69
R716VCB	7311518255497	352	15	40	562
R772V	7311518301385	352	15	14	562
R773V	7311518324414	352	15	1	562
R801P	7311518234126	352	10	1	556
R802P	7311518234133	352	10	1	556
R803P	7311518234140	352	10	1	556
R804P	7311518240806	352	10	1	556
R811P	7311518234058	352	10	1	556
R812P	7311518234065	352	10	1	556
R813P	7311518234072	352	10	1	556
R815P	7311518240752	352	10	1	556
R900P	7311518234188	352	10	1	556
R901P	7311518234195	352	10	30	556
R902P	7311518234201	352	10	24	556
R903P	7311518234218	352	10	1	556
R904P	7311518234225	352	10	1	557
R905P	7311518234232	352	10	1	557
R905P-BULK50	7311518252250	352	10	50	557
R906P	7311518234249	352	10	1	557
R906P-BULK50	7311518252267	352	10	50	557
R907P	7311518234256	352	10	1	557
RAIL-187	7314153003621	354	15	3	67
RAIL-264	7314153003638	354	15	3	67
RAIL-340	7314153003645	354	15	3	



CUENTA SUBGRUPO



RT823P	7311518234119	352	10	6	556
RT824P	7311518240776	352	10	1	556
RX 01	7314150103263	340	10	1	582
RX 7490	7314150103195	340	10	10	580
RX 7590	7314150103201	340	10	10	580
RX 7890	7314150103218	340	10	10	581
RX 7891	7314150103225	340	10	10	581
RX 7892	7314150103232	340	10	10	581
RX 7893	7314150103249	340	10	10	581
RX 8130	7314150103003	340	10	10	579
RX 8131	7314150103010	340	10	10	579
RX 8132	7314150103027	340	10	10	579
RX 8140	7314150103034	340	10	10	579
RX 8141	7314150103041	340	10	10	579
RX 8142	7314150103058	340	10	10	579
RX 8143	7314150103065	340	10	10	578
RX 8144	7314150103072	340	10	10	578
RX 8145	7314150103089	340	10	10	578
RX 8146	7314150103096	340	10	10	578
RX 8147	7314150103102	340	10	10	578
RX 8148	7314150103119	340	10	10	578
RX 8149	7314150103126	340	10	10	579
RX 8150	7314150103133	340	10	10	579
RX 8151	7314150103140	340	10	10	579
RX 8152	7314150103157	340	10	10	579
RX 8160	7314150111534	340	10	10	579
RX 8161	7314150111541	340	10	10	579
RX 8162	7314150111558	340	10	10	579
RX 8211	7314150103188	340	10	10	579
RX 8247	7314150103164	340	10	10	579
RX 8248	7314150103171	340	10	10	579
RX8233	7314150113521	340	10	10	580
RX8234	7314150113538	340	10	10	580
RX8237	7314150113545	340	10	10	580
S0810L	7314150256594	354	25	20	73
S10/SH11	7314153013408	366	10	1	51
S10/SH6	7314153013309	366	10	1	51
S103	7314150257119	354	25	2	96
S103-CASE	7314150321261	354	25	1	112
S106	7314150103997	354	25	2	75
S106-CASE	7314150214686	354	25	1	112
S108	7314150122257	354	25	2	96
S108-CASE	7314150349319	354	25	1	112
S1214L	7314150256600	354	25	10	83
S138	7314150195022	354	25	2	75
S138-CASE	7314150349296	354	25	1	112
S140T	7314150125203	354	10	1	84
S140T-R	7314150136353	354	10	10	84
S160	7314150104031	354	25	6	74
S160-CASE	7314150136209	354	25	1	112
S160AF	7314150137510	354	25	6	74
S1612L	7314150256617	354	25	4	95
S18TORX	7314150412464	354	25	4	96
S20/SH12	7314153013378	366	10	1	43
S20/SH6	7314153013316	366	10	1	42
S240	7314150104017	354	25	4	95
S240AF	7314150111077	354	25	4	95
S290	7314153000859	354	25	6	74
S290-CASE	7314150126385	354	25	1	112
S330	7314150104024	354	25	6	83
S330-CASE	7314150136223	354	25	1	112
S330AF	7314150137503	354	25	6	83
S330L	7314150256587	354	25	4	84
S330L-CASE	7311518337674	354	25	1	112
S380	7314150168934	354	25	4	84
S400	7314150111053	354	25	2	96
S400-CASE	7314150187300	354	25	1	112
S410	7314153019370	354	25	75	75
S410-CASE	7314150321223	354	25	1	112
S460	7314150111060	354	25	6	74
S460-CASE	7314150321209	354	25	1	112
S4RM-12-15	7314150179954	366	25	1	48
S4RM-16-19	7314150179961	366	25	1	48
S4RM-21-27	7314150179978	366	25	1	48
S4RM-30-36	7314150179985	366	25	1	48
S4RM-4-7	7314150179930	366	25	1	48
S4RM-8-11	7314150179947	366	25	1	48
S4RM/3T	7314150117406	366	25	20	48
S4RM/4T	7314150179916	366	25	1	48
S4RM/5T	7314150179923	366	25	1	48
S530T	7314150169122	354	10	4	84
S560	7314150122264	354	25	4	96
S560-CASE	7314150321216	354	25	1	112
S800	7314150165599	354	25	2	75
S800-CASE	7314150321230	354	25	1	112
S81MIX	7314150180127	354	25	2	96
S81MIX-CASE	7314150321247	354	25	1	112
S87+7	7314150103980	354	25	2	75
S87+7-CASE	7314150126392	354	25	1	112
S910	7314150104000	354	25	2	74
S910-CASE	7314150137961	354	25	1	112
S93	7314150129805	354	15	1	100
S95	7314150409167	354	25	2	96
SB-2058/S26	7314151849498	354	25	1	166
SB-2444	7314150189250	334	10	1	523
SB-2448	7314150136056	334	10	12	513
SB-2449	7314150194049	334	10	10	513
SB-3732-2-125	7314151847869	358	15	60	546



CUENTA SUBGRUPO



SB-3732-2.5-125	7314151847876	358	15	60	546
SB-3732-3.2-125	7314151847883	358	15	60	546
SB-3732-4-125	7314151847890	358	15	1	546
SB-3734N-10-150	7314151848101	358	15	1	544
SB-3734N-2-150	7314151847968	358	15	1	544
SB-3734N-3-150	7314151847975	358	15	1	544
SB-3734N-4-150	7314151847982	358	15	60	544
SB-3734N-5-150	7314151847999	358	15	1	544
SB-3734N-6-150	7314151848071	358	15	60	544
SB-3734N-7-150	7314151848088	358	15	1	544
SB-3734N-8-150	7314151848095	358	15	1	544
SB-3735N-2-100	7314151847906	358	15	1	543
SB-3735N-4-120	7314151847913	358	15	60	543
SB-3735N-5-120	7314151847920	358	15	1	543
SB-3735N-6-150	7314151847937	358	15	1	543
SB-3735N-8-150	7314151847944	358	15	1	543
SB-3740-125	7314150115990	358	15	5	542
SB-3740-150	7314150116003	358	15	5	542
SB-3740-175	7314150116010	358	15	5	542
SB-3740-200	7314150116027	358	15	5	542
SB-3740-250	7314150116034	358	15	5	542
SB-3740-300	7314150116041	358	15	5	542
SB-9526/S6	7314150154234	346	30	20	148
SB111M-10	7314151839864	366	10	1	40
SB111M-11	7314151839871	366	10	1	40
SB111M-12	7314151839888	366	10	1	40
SB111M-13	7314151839895	366	10	1	40
SB111M-14	7314151839901	366	10	1	40
SB111M-15	7314151839918	366	10	1	40
SB111M-16	7314151839925	366	10	1	40
SB111M-17	7314151839932	366	10	1	40
SB111M-18	7314151839949	366	10	1	40
SB111M-19	7314151839956	366	10	1	40
SB111M-20	7314151839963	366	10	1	40
SB111M-21	7314151839970	366	10	1	40
SB111M-22	7314151839987	366	10	1	40
SB111M-23	7314151839994	366	10	1	40
SB111M-24	7314151840006	366	10	1	40
SB111M-25	7314151840013	366	10	1	40
SB111M-26	7314151840020	366	10	1	40
SB111M-27	7314151840037	366	10	1	40
SB111M-28	7314150432103	366	10	1	40
SB111M-29	7314151840051	366	10	1	40
SB111M-30	7314151840068	366	10	1	40
SB111M-32	7314151840075	366	10	1	40
SB111M-5.5	7314151839819	366	10	1	40
SB111M-6	7314151839826	366	10	1	40
SB111M-7	7314151839833	366	10	1	40
SB111M-8	7314151839840	366	10	1	40
SB111M-9	7314151839857	366	10	1	40
SB141.007.075	7314150282753	350	11	1	180
SB141.008.075	7314150282760	350	11	1	180
SB141.009.075	7314150282777	350	11	1	180
SB141.010.075	7314150282784	350	11	1	180
SB141.015.100	7314150282791	350	11	1	180
SB141.020.100	7314150282807	350	11	1	180
SB141.025.125	7314150282814	350	11	1	180
SB141.027.125	7314150282821	350	11	1	180
SB141.030.150	7314150282838	350	11	1	180
SB141.040.150	7314150282845	350	11	1	180
SB142.000.075	7314150282579	350	25	1	437
SB142.001.080	7314150282586	350	25	1	437
SB142.002.100	7314150282593	350	25	1	437
SB142.003.150	7314150282609	350	25	1	437
SB143.020.100	7314150282852	350	11	1	180
SB143.025.100	7314150282859	350	11	1	180
SB143.030.100	7314150282876	350	11	1	180
SB143.040.100	7314150282883	350	11	1	180
SB143.050.100	7314150282890	350	11	1	180
SB143.060.125	7314150282906	350	11	1	180
SB143.080.150	7314150282913	350	11	1	180
SB144.001.100	7314150282951	350	11	1	180
SB144.002.125	7314150282968	350	11	1	180
SB144.003.150	7314150282975	350	11	1	180
SB145.006.100	7314150282920	350	11	1	180
SB146.006.100	7314150282937	350	11	1	180
SB147.001.400	7314150285617	322	10	1	181
SB147.003.400	7314150285624	322	10	1	181
SB148.001.080	7314150314577	350	25	1	437
SB148.002.100	7314150314584	350	25	1	437
SB149.001.080	7314150314591	350	25	1	438
SB149.002.100	7314150314607	350	25	1	438
SB150.010.100	7314150343492	350	25	1	437
SB150.015.125	7314150343515	350	25	1	437
SB150.020.125	7314150343577	350	25	1	437
SB150.025.150	7314150343584	350	25	1	437
SB190.040.075	7314150281985	350	1		



CUENTA SUBGRUPO



SB191.030.075	7314150282104	350	11	1	178
SB191.030.100	7314150282111	350	11	1	178
SB191.030.200	7314150282128	350	11	1	178
SB191.035.100	7314150282135	350	11	1	178
SB191.040.100	7314150282142	350	11	1	178
SB191.040.125	7314150282159	350	11	1	178
SB191.040.250	7314150282166	350	11	1	178
SB191.055.125	7314150282173	350	11	1	178
SB191.055.150	7314150282180	350	11	1	178
SB191.055.300	7314150282197	350	11	1	178
SB191.065.150	7314150282203	350	11	1	178
SB191.065.300	7314150282210	350	11	1	178
SB192.000.075	7314150282357	350	11	1	179
SB192.000.200	7314150282364	350	11	1	179
SB192.001.100	7314150282371	350	11	1	179
SB192.001.250	7314150282388	350	11	1	179
SB192.002.125	7314150282395	350	11	1	179
SB192.002.300	7314150282401	350	11	1	179
SB192.003.150	7314150282418	350	11	1	179
SB192.004.200	7314150282425	350	11	1	179
SB193.000.075	7314150282456	350	11	1	179
SB193.001.100	7314150282463	350	11	1	179
SB193.002.125	7314150282470	350	11	1	179
SB193.003.150	7314150282487	350	11	1	179
SB193.004.200	7314150282494	350	11	1	179
SB194.004.075	7314150282616	350	11	1	179
SB194.005.075	7314150282623	350	11	1	179
SB194.006.075	7314150282630	350	11	1	179
SB194.007.075	7314150282647	350	11	1	179
SB194.008.075	7314150282654	350	11	1	179
SB194.009.075	7314150282661	350	11	1	179
SB194.010.075	7314150282678	350	11	1	179
SB194.015.100	7314150282685	350	11	1	179
SB194.020.100	7314150282692	350	11	1	179
SB194.025.125	7314150282708	350	11	1	179
SB194.027.125	7314150282715	350	11	1	179
SB194.030.150	7314150282722	350	11	1	179
SB194.040.150	7314150282739	350	11	1	179
SB194.045.150	7314150282746	350	11	1	179
SB195.001.025	7314150282432	350	11	1	179
SB195.002.025	7314150282449	350	11	1	179
SB195.006.050	7314150289516	350	11	1	181
SB195.040.025	7314150282227	350	11	1	178
SB195.050.025	7314150282234	350	11	1	178
SB195.060.025	7314150282241	350	11	1	178
SB195.901.025	7314150282500	350	11	1	179
SB195.902.025	7314150282517	350	11	1	179
SB1952M-10	7314150105205	366	10	1	44
SB1952M-12	7314150105229	366	10	1	44
SB1952M-13	7314150105236	366	10	1	44
SB1952M-14	7314150105243	366	10	1	44
SB1952M-17	7314150105274	366	10	1	44
SB1952M-19	7314150105298	366	10	1	44
SB1952M-24	7314150105342	366	10	1	44
SB1952M-7	7314150105441	366	10	1	44
SB1952M-8	7314150105458	366	10	1	44
SB196.025.075	7314150282258	350	25	1	437
SB196.030.100	7314150282265	350	25	1	437
SB196.035.100	7314150282272	350	25	1	437
SB196.040.100	7314150282289	350	25	1	437
SB196.055.125	7314150282296	350	25	1	437
SB196.065.150	7314150282302	350	25	1	437
SB196.080.175	7314150282326	350	25	1	437
SB196.100.200	7314150282333	350	25	1	437
SB196.120.200	7314150282340	350	25	1	437
SB197.000.075	7314150282524	350	25	1	437
SB197.001.080	7314150282531	350	25	1	437
SB197.002.100	7314150282548	350	25	1	437
SB197.003.150	7314150282555	350	25	1	437
SB197.004.200	7314150282562	350	25	1	437
SB198.040.125	7314150282982	350	11	1	181
SB198.045.125	7314150282999	350	11	1	181
SB198.050.150	7314150283002	350	11	1	181
SB198.055.150	7314150283019	350	11	1	181
SB198.060.150	7314150283026	350	11	1	181
SB198.060.150F	7314150283033	350	11	1	181
SB198.070.150	7314150283040	350	11	1	181
SB198.070.150F	7314150283057	350	11	1	181
SB198.080.150	7314150283064	350	11	1	181
SB198.080.150F	7314150283071	350	11	1	181
SB198.090.150	7314150283088	350	11	1	181
SB198.100.150	7314150283095	350	11	1	181
SB198.110.150	7314150283101	350	11	1	181
SB198.120.150	7314150283118	350	11	1	181
SB198.130.150	7314150283125	350	11	1	181
SB198.140.150	7314150283132	350	11	1	181
SB199.055.125	7314150283149	350	25	1	438
SB199.060.125	7314150283156	350	25	1	438
SB199.070.125	7314150283163	350	25	1	438
SB199.080.125	7314150283170	350	25	1	438
SB199.090.125	7314150283187	350	25	1	438
SB199.100.125	7314150283194	350	25	1	438
SB199.110.125	7314150283200	350	25	1	438
SB199.120.125	7314150287765	350	25	1	438
SB199.130.125	7314150287796	350	25	1	438
SB2446-EL	7314150312207	334	10	10	523
SB27M-10-11	7314150180851	366	15	10	59
SB27M-12-13	7314150180868	366	15	10	59



CUENTA SUBGRUPO



SB27M-14-15	7314150180875	366	15	10	59
SB27M-16-17	7314150180882	366	15	10	59
SB27M-18-19	7314150180899	366	15	10	59
SB27M-20-22	7314150180905	366	15	10	59
SB27M-21-23	7314150180912	366	15	5	59
SB27M-24-26	7314150180929	366	15	5	59
SB27M-6-7	7314150180837	366	15	10	59
SB27M-8-9	7314150180844	366	15	10	59
SB6700SM-10	7314150104383	354	10	1	64
SB6700SM-11	7314150104390	354	10	1	64
SB6700SM-12	7314150104406	354	10	1	64
SB6700SM-13	7314150104413	354	10	1	64
SB6700SM-14	7314150104420	354	10	1	64
SB6700SM-4	7314150104307	354	10	1	64
SB6700SM-4.5	7314150104314	354	10	1	64
SB6700SM-5	7314150104321	354	10	1	64
SB6700SM-5.5	7314150104338	354	10	1	64
SB6700SM-6	7314150104345	354	10	1	64
SB6700SM-7	7314150104352	354	10	1	64
SB6700SM-8	7314150104369	354	10	1	64
SB6700SM-9	7314150104376	354	10	1	64
SB6700SZ-1/2	7314150240609	354	10	1	64
SB6700SZ-1/4	7314150240616	354	10	1	64
SB6700SZ-1/8	7314150412495	354	10	5	64
SB6700SZ-11/32	7314150240623	354	10	1	64
SB6700SZ-3/16	7314150240630	354	10	1	64
SB6700SZ-3/8	7314150240647	354	10	1	64
SB6700SZ-5/16	7314150240654	354	10	1	64
SB6700SZ-5/32	7314150240661	354	10	1	64
SB6700SZ-7/16	7314150240678	354	10	1	64
SB6700SZ-7/32	7314150240685	354	10	1	64
SB6700SZ-9/16	7314150240692	354	10	1	64
SB6700SZ-9/32	7314150240708	354	10	1	64
SB6700TORX-E10	7314150240715	354	10	1	64
SB6700TORX-E4	7314150240722	354	10	1	64
SB6700TORX-E5	7314150240739	354	10	1	64
SB6700TORX-E6	7314150240746	354	10	1	64
SB6700TORX-E7	7314150240753	354	10	1	64
SB6700TORX-E8	7314150240760	354	10	1	64
SB6709F-4.5	7314150240777	354	10	1	67
SB6709F-5.5	7314150240784	354	10	1	67
SB6709F-6.5	7314150240791	354	10	1	67
SB6709F-8	7314150240807	354	10	1	67
SB6709M-3	7314150240814	354	10	1	68
SB6709M-4	7314150240821	354	10	1	68
SB6709M-5	7314150240838	354	10	1	68
SB6709M-6	7314150240845	354	10	1	68
SB6709M-8	7314150240852	354	10	1	68
SB6709PH-1	7314150240869	354	10	1	67
SB6709PH-2	7314150240876	354	10	1	67
SB6709PH-3	7314150240883	354	10	1	67
SB6709PZ-1	7314150240890	354	10	1	67
SB6709PZ-2	7314150240906	354	10	1	67
SB6709PZ-3	7314150240913	354	10	1	67
SB6709TORX-R-T10	7314150240975	354	10	1	68
SB6709TORX-R-T15	7314150240937	354	10	1	68
SB6709TORX-R-T20	7314150240944	354	10	1	68
SB6709TORX-R-T25	7314150240951	354	10	1	68
SB6709TORX-R-T8	7314150240968	354	10	1	68
SB6709TORX-T10	7314150240982	354	10	1	68
SB6709TORX-T15	7314150240999	354	10	1	68
SB6709TORX-T20	7314150241002	354	10	1	68
SB6709TORX-T25	7314150241019	354	10	1	68
SB6709TORX-T27	7314150241026	354	10	1	68
SB6709TORX-T30	7314150241033	354	10	1	68
SB6709TORX-T40	7314150241040	354	10	1	68
SB6709TORX-T8	7314150241057	354	10	1	68
SB6709TORX-T9	7314150241064	354	10	1	68
SB6950	7314150104987	354	20	1	69
SB6950RN	7314150104994	354	20	1	69
SB6954	7314150250158	354	15	10	66
SB6956	7314150241071	354	15	1	66
SB6958	7314150240296	354	15	1	66
SB6960	7314150104925	354	15	1	66
SB6961	7314150104932	354	15	1	66
SB6962	7314150104949	354	15	1	66
SB6962L	7314150254743	354	15	1	66
SB6963	7314150241088	354	15	1	66
SB6966	7314150241095	354	15	1	66
SB6M-10-11	7314150105731	366	10	1	49
SB6M-12-13	73				

SB7400SM-11



SB7400SM-11	7314150241118	354	10	1	76
SB7400SM-12	7314150241125	354	10	1	76
SB7400SM-13	7314150241132	354	10	1	76
SB7400SM-14	7314150241149	354	10	1	76
SB7400SM-15	7314150241156	354	10	1	76
SB7400SM-16	7314150241170	354	10	1	76
SB7400SM-17	7314150241187	354	10	1	76
SB7400SM-18	7314150241194	354	10	1	76
SB7400SM-19	7314150241200	354	10	1	76
SB7400SM-20	7314150241217	354	10	1	76
SB7400SM-21	7314150241224	354	10	1	76
SB7400SM-22	7314150241231	354	10	1	76
SB7400SM-6	7314150241248	354	10	1	76
SB7400SM-7	7314150241255	354	10	1	76
SB7400SM-8	7314150241262	354	10	1	76
SB7400SM-9	7314150241279	354	10	1	76
SB7400TORX-E10	7314150241286	354	10	1	77
SB7400TORX-E11	7314150241293	354	10	1	77
SB7400TORX-E12	7314150241309	354	10	1	77
SB7400TORX-E14	7314150241316	354	10	1	77
SB7400TORX-E16	7314150241323	354	10	1	77
SB7400TORX-E18	7314150241330	354	10	1	77
SB7400TORX-E8	7314150241347	354	10	1	77
SB7409BH-10	7314150241354	354	10	1	81
SB7409BH-4	7314150241361	354	10	1	81
SB7409BH-5	7314150241378	354	10	1	81
SB7409BH-6	7314150241385	354	10	1	81
SB7409BH-8	7314150241392	354	10	1	81
SB7409F-10	7314150241408	354	10	1	80
SB7409F-6.5	7314150241415	354	10	1	80
SB7409F-8	7314150241422	354	10	1	80
SB7409M-10	7314150241439	354	10	1	81
SB7409M-3	7314150241446	354	10	1	81
SB7409M-4	7314150241453	354	10	1	81
SB7409M-5	7314150241460	354	10	1	81
SB7409M-6	7314150241477	354	10	1	81
SB7409M-7	7314150241484	354	10	1	81
SB7409M-8	7314150241491	354	10	1	81
SB7409PH-1	7314150241507	354	10	1	80
SB7409PH-2	7314150241514	354	10	1	80
SB7409PH-3	7314150241521	354	10	1	80
SB7409TORX-R-T27	7314150241538	354	10	1	80
SB7409TORX-R-T30	7314150241545	354	10	1	80
SB7409TORX-R-T40	7314150241552	354	10	1	80
SB7409TORX-R-T45	7314150241569	354	10	1	80
SB7409TORX-R-T50	7314150241576	354	10	1	80
SB7409TORX-T20	7314150241583	354	10	1	80
SB7409TORX-T25	7314150241590	354	10	1	80
SB7409TORX-T25-L	7314150241606	354	10	1	80
SB7409TORX-T27	7314150241613	354	10	1	80
SB7409TORX-T30	7314150241620	354	10	1	80
SB7409TORX-T30-L	7314150241637	354	10	1	80
SB7409TORX-T40	7314150241644	354	10	1	80
SB7409TORX-T40-L	7314150241651	354	10	1	80
SB7409TORX-T45	7314150241668	354	10	1	80
SB7409TORX-T45-L	7314150241675	354	10	1	80
SB7409TORX-T50	7314150241682	354	10	1	80
SB7409TORX-T50-L	7314150241699	354	10	1	80
SB7750	7314150187850	354	20	1	79
SB7750RN	7314153003966	354	20	1	79
SB7754	7314150250165	354	15	8	77
SB7755-3/8	7314153010100	354	20	1	79
SB7757	7314150254842	354	15	1	78
SB7758	7314150240302	354	15	1	77
SB7759	7314150254859	354	15	1	78
SB7760	7314153003980	354	15	1	78
SB7761	7314150241705	354	15	1	78
SB7762	7314153004000	354	15	1	78
SB7764	7314150241729	354	15	1	78
SB7765	7314150241736	354	15	1	66
SB7766	7314150241743	354	15	1	78
SB7767	7314150254897	354	15	1	67
SB7800DM-10	7314150104451	354	10	1	86
SB7800DM-11	7314150104468	354	10	1	86
SB7800DM-12	7314150104475	354	10	1	86
SB7800DM-13	7314150104482	354	10	1	86
SB7800DM-14	7314150104499	354	10	1	86
SB7800DM-15	7314150104505	354	10	1	86
SB7800DM-16	7314150104512	354	10	1	86
SB7800DM-17	7314150104529	354	10	1	86
SB7800DM-18	7314150104536	354	10	1	86
SB7800DM-19	7314150104543	354	10	1	86
SB7800DM-20	7314150104550	354	10	1	86
SB7800DM-21	7314150104567	354	10	1	86
SB7800DM-22	7314150104574	354	10	1	86
SB7800DM-23	7314150104581	354	10	1	86
SB7800DM-24	7314150104598	354	10	1	86
SB7800DM-25	7314150104604	354	10	1	86
SB7800DM-26	7314150104611	354	10	1	86
SB7800DM-27	7314150104628	354	10	1	86
SB7800DM-28	7314150104635	354	10	1	86
SB7800DM-29	7314150104642	354	10	1	86
SB7800DM-30	7314150104659	354	10	1	86
SB7800DM-32	7314150104666	354	10	1	86
SB7800DM-33	7314150240319	354	10	1	86
SB7800DM-34	7314150327607	354	10	1	86
SB7800DM-36	7314150104673	354	10	1	86
SB7800DM-8	7314150104437	354	10	1	86



SB7800DM-9	7314150104444	354	10	1	86
SB7800DZ-1	7314150234912	354	10	1	86
SB7800DZ-1.1/16	7314150240326	354	10	1	86
SB7800DZ-1.1/4	7314150240333	354	10	1	86
SB7800DZ-1.1/8	7314150240340	354	10	1	86
SB7800DZ-1.3/16	7314150240357	354	10	1	86
SB7800DZ-1.5/16	7314150240364	354	10	1	86
SB7800DZ-1/2	7314150234899	354	10	1	86
SB7800DZ-11/16	7314150234929	354	10	1	86
SB7800DZ-13/16	7314150234936	354	10	1	86
SB7800DZ-15/16	7314150234943	354	10	1	86
SB7800DZ-19/32	7314150240371	354	10	1	86
SB7800DZ-25/32	7314150240388	354	10	1	86
SB7800DZ-3/4	7314150234950	354	10	1	86
SB7800DZ-3/8	7314150234967	354	10	1	86
SB7800DZ-5/8	7314150234974	354	10	1	86
SB7800DZ-7/16	7314150234981	354	10	1	86
SB7800DZ-7/8	7314150234998	354	10	1	86
SB7800DZ-9/16	7314150235005	354	10	1	86
SB7800SM-10	7314150104703	354	10	1	85
SB7800SM-11	7314150104710	354	10	1	85
SB7800SM-12	7314150104727	354	10	1	85
SB7800SM-13	7314150104734	354	10	1	85
SB7800SM-14	7314150104741	354	10	1	85
SB7800SM-15	7314150104758	354	10	1	85
SB7800SM-16	7314150104765	354	10	1	85
SB7800SM-17	7314150104772	354	10	1	85
SB7800SM-18	7314150104789	354	10	1	85
SB7800SM-19	7314150104796	354	10	1	85
SB7800SM-20	7314150240395	354	10	1	85
SB7800SM-21	7314150104819	354	10	1	85
SB7800SM-22	7314150104826	354	10	1	85
SB7800SM-23	7314150104833	354	10	1	85
SB7800SM-24	7314150104840	354	10	1	85
SB7800SM-25	7314150104857	354	10	1	85
SB7800SM-26	7314150104864	354	10	1	85
SB7800SM-27	7314150104871	354	10	1	85
SB7800SM-28	7314150104888	354	10	1	85
SB7800SM-29	7314150240401	354	10	1	85
SB7800SM-30	7314150104895	354	10	1	85
SB7800SM-32	7314150104901	354	10	1	85
SB7800SM-33	7314150240418	354	10	1	85
SB7800SM-34	7314150235018	354	10	1	85
SB7800SM-36	7314150235025	354	10	1	85
SB7800SM-8	7314150104680	354	10	1	85
SB7800SM-9	7314150104697	354	10	1	85
SB7800TORX-E10	7314150240104	354	10	1	87
SB7800TORX-E11	7314150240111	354	10	1	87
SB7800TORX-E12	7314150240128	354	10	1	87
SB7800TORX-E14	7314150240135	354	10	1	87
SB7800TORX-E16	7314150240142	354	10	1	87
SB7800TORX-E18	7314150240159	354	10	1	87
SB7800TORX-E20	7314150240166	354	10	1	87
SB7800TORX-E24	7314150240173	354	10	1	87
SB7800TORX-E8	7314150240180	354	10	1	87
SB7805DM-10	7314150234851	354	10	1	86
SB7805DM-12	7314150234868	354	10	1	86
SB7805DM-13	7314150235032	354	10	1	86
SB7805DM-14	7314150235049	354	10	1	86
SB7805DM-15	7314150235056	354	10	1	86
SB7805DM-16	7314150235063	354	10	1	86
SB7805DM-17	7314150235070	354	10	1	86
SB7805DM-18	7314150235087	354	10	1	86
SB7805DM-19	7314150235094	354	10	1	86
SB7805DM-21	7314150235100	354	10	1	86
SB7805DM-22	7314150235117	354	10	1	86
SB7805DM-23	7314150327614	354	10	1	86
SB7805DM-24	7314150235124	354	10	1	86
SB7805DM-26	7314150240197	354	10	1	86
SB7805DM-27	7314150235131	354	10	1	86
SB7805DM-30	7314150235148	354	10	1	86
SB7805DM-32	7314150240203	354	10	1	86
SB7805SM-10	7314150235155	354	10	1	85
SB7805SM-12	7314150235162	354	10	1	85
SB7805SM-13	7314150235179	354	10	1	85
SB7805SM-14	7314150235193	354	10	1	85
SB7805SM-15	7314150235216	354	10	1	85
SB7805SM-16	7314150240210	354	10	1	85
SB7805SM-17	7314150235223	354	10	1	85
SB7805SM-18	7314150235230	354	10	1	85
SB7805SM-19	7314150235247	354	10	1	85
SB7805SM-21	7314150235254	354	10	1	85
SB7805SM-22	7314150235261	354	10	1	85
SB7805SM-23	7314150240234	354	10	1	85
SB7805SM-24	7314150235278	354	10	1	85
SB7805SM-26	7314150240258	354	10	1	85
SB7805SM-27	7314150235285	354	10	1	85
SB7805SM-30	7314150235292	354	10	1	85
SB7805SM-32	7314150235308	354	10	1	85



CUENTA	SUBGRUPO				
SB7809M-5-180	7314153004116	354	10	1	90
SB7809M-6	7314153004123	354	10	1	89
SB7809M-6-100	7314153013976	354	10	1	90
SB7809M-6-140	7314153013231	354	10	1	90
SB7809M-7	7314153004130	354	10	1	89
SB7809M-7-100	7314153004147	354	10	1	90
SB7809M-8	7314153004154	354	10	1	89
SB7809M-8-120	7314153004161	354	10	1	90
SB7809M-9	7314153004178	354	10	1	89
SB7809TORX-T20	7314153004017	354	10	1	89
SB7809TORX-T25	7314153004024	354	10	1	89
SB7809TORX-T27	7314153004031	354	10	1	89
SB7809TORX-T30	7314153004048	354	10	1	89
SB7809TORX-T40	7314153004055	354	10	1	89
SB7809TORX-T45	7314153004062	354	10	1	89
SB7809TORX-T50	7314153004079	354	10	1	89
SB7809TORX-T55	7314153004086	354	10	1	89
SB7809TORX-T60	7314153004093	354	10	1	89
SB8110-1/2	7314153004246	354	20	1	91
SB8150-1/2	7314150105014	354	20	1	90
SB8150RN-1/2	7314150105007	354	20	1	90
SB8154-1/2	7314150327621	354	15	1	87
SB8155-1/2	7314150105021	354	20	1	90
SB8158-1/2	7314153004253	354	15	1	87
SB8159-1/2	7314150104956	354	15	1	87
SB8160-1/2	7314150104963	354	15	1	87
SB8162-1/2	7314150327232	354	15	1	87
SB8166-1/2	7314153004260	354	15	1	87
SBA6700DM-10	7314150235575	354	10	1	64
SBA6700DM-11	7314150241750	354	10	1	64
SBA6700DM-12	7314150241767	354	10	1	64
SBA6700DM-13	7314150241774	354	10	1	64
SBA6700DM-14	7314150241781	354	10	1	64
SBA6700DM-5	7314150255054	354	10	1	64
SBA6700DM-5.5	7314150241798	354	10	1	64
SBA6700DM-6	7314150241804	354	10	1	64
SBA6700DM-7	7314150241811	354	10	1	64
SBA6700DM-8	7314150241828	354	10	1	64
SBA6700DM-9	7314150241835	354	10	1	64
SBA6700DZ-1/2	7314150241842	354	10	1	64
SBA6700DZ-1/4	7314150241859	354	10	1	64
SBA6700DZ-11/32	7314150241866	354	10	1	64
SBA6700DZ-3/16	7314150241873	354	10	1	64
SBA6700DZ-3/8	7314150241880	354	10	1	64
SBA6700DZ-5/16	7314150241897	354	10	1	64
SBA6700DZ-7/16	7314150241903	354	10	1	64
SBA6700DZ-7/32	7314150241910	354	10	1	64
SBA6700DZ-9/16	7314150241927	354	10	1	64
SBA6700DZ-9/32	7314150241934	354	10	1	64
SBA6709M-2.5	7314150254835	354	10	1	68
SBA6709M-3	7314150254828	354	10	1	68
SBA6709M-4	7314150254811	354	10	1	68
SBA6709M-5	7314150254804	354	10	1	68
SBA6709M-6	7314150254798	354	10	1	68
SBA6709Z-1/8	7314150254781	354	10	1	68
SBA6709Z-3/16	7314150254774	354	10	1	68
SBA6709Z-5/32	7314150254767	354	10	1	68
SBA6709Z-9/64	7314150254750	354	10	1	68
SBA6800DM-10	7314150250172	354	10	10	65
SBA6800DM-11	7314150250189	354	10	10	65
SBA6800DM-12	7314150250196	354	10	10	65
SBA6800DM-13	7314150250202	354	10	10	65
SBA6800DM-14	7314150250219	354	10	10	65
SBA6800DM-4	7314150250226	354	10	10	65
SBA6800DM-5	7314150250233	354	10	10	65
SBA6800DM-5.5	7314150250240	354	10	10	65
SBA6800DM-6	7314150250257	354	10	10	65
SBA6800DM-7	7314150250264	354	10	10	65
SBA6800DM-8	7314150250271	354	10	10	65
SBA6800DM-9	7314150250288	354	10	10	65
SBA6800DZ-1/2	7314150250295	354	10	10	65
SBA6800DZ-1/4	7314150250301	354	10	10	65
SBA6800DZ-11/32	7314150250318	354	10	10	65
SBA6800DZ-3/16	7314150250325	354	10	10	65
SBA6800DZ-3/8	7314150250332	354	10	10	65
SBA6800DZ-5/16	7314150250349	354	10	10	65
SBA6800DZ-7/16	7314150250356	354	10	10	65
SBA6800DZ-7/32	7314150250363	354	10	10	65
SBA6800DZ-9/16	7314150250370	354	10	10	65
SBA6800DZ-9/32	7314150250387	354	10	10	65
SBA7400DM-10	7314150241941	354	10	1	76
SBA7400DM-11	7314150241958	354	10	1	76
SBA7400DM-12	7314150241965	354	10	1	76
SBA7400DM-13	7314150241972	354	10	1	76
SBA7400DM-14	7314150241989	354	10	1	76
SBA7400DM-15	7314150241996	354	10	1	76
SBA7400DM-16	7314150242009	354	10	1	76
SBA7400DM-17	7314150242016	354	10	1	76
SBA7400DM-18	7314150242023	354	10	1	76
SBA7400DM-19	7314150242030	354	10	1	76
SBA7400DM-20	7314150242047	354	10	1	76
SBA7400DM-21	7314150242054	354	10	1	76
SBA7400DM-22	7314150242061	354	10	1	76
SBA7400DM-6	7314150242078	354	10	1	76
SBA7400DM-7	7314150242085	354	10	1	76
SBA7400DM-8	7314150242092	354	10	1	76
SBA7400DM-9	7314150242108	354	10	1	76
SBA7400DZ-1/2	7314150254705	354	10	1	76



CUENTA	SUBGRUPO				
SBA7400DZ-1/4	7314150242115	354	10	1	76
SBA7400DZ-11/16	7314150242122	354	10	1	76
SBA7400DZ-13/16	7314150242139	354	10	1	76
SBA7400DZ-17/32	7314150242146	354	10	1	76
SBA7400DZ-19/32	7314150242153	354	10	1	76
SBA7400DZ-3/4	7314150242160	354	10	1	76
SBA7400DZ-3/8	7314150242177	354	10	1	76
SBA7400DZ-5/16	7314150242184	354	10	1	76
SBA7400DZ-5/8	7314150242191	354	10	1	76
SBA7400DZ-7/16	7314150242207	354	10	1	76
SBA7400DZ-7/8	7314150242214	354	10	1	76
SBA7400DZ-9/16	7314150242221	354	10	1	76
SBA7402DM-10	7314150250394	354	10	10	77
SBA7402DM-11	7314150250400	354	10	10	77
SBA7402DM-12	7314150250417	354	10	10	77
SBA7402DM-13	7314150250424	354	10	10	77
SBA7402DM-14	7314150250431	354	10	10	77
SBA7402DM-15	7314150250448	354	10	1	77
SBA7402DM-16	7314150250455	354	10	10	77
SBA7402DM-17	7314150250462	354	10	10	77
SBA7402DM-18	7314150250479	354	10	10	77
SBA7402DM-19	7314150250486	354	10	10	77
SBA7402DM-7	7314150250493	354	10	10	77
SBA7402DM-8	7314150250509	354	10	10	77
SBA7402DM-9	7314150250516	354	10	10	77
SBA7402DZ-1/2	7314150250523	354	10	10	77
SBA7402DZ-1/4	7314150250530	354	10	10	77
SBA7402DZ-11/16	7314150250547	354	10	10	77
SBA7402DZ-13/16	7314150250554	354	10	10	77
SBA7402DZ-19/32	7314150250561	354	10	10	77
SBA7402DZ-3/4	7314150250578	354	10	10	77
SBA7402DZ-3/8	7314150250585	354	10	10	77
SBA7402DZ-5/16	7314150250592	354	10	10	77
SBA7402DZ-5/8	7314150250608	354	10	10	77
SBA7402DZ-7/16	7314150250615	354	10	10	77
SBA7402DZ-7/8	7314150250622	354	10	10	77
SBA7402DZ-9/16	7314150250639	354	10	10	77
SBE-8135TB	7314150320424	350	10	1	187
SBE-8145TB	7314150320431	350	10	1	187
SBE-8150TB	7314150320448	350	10	1	187
SBE-8155TB	7314150320455	350	10	1	187
SBE-8610TB	7314150320493	350	10	1	187
SBE-8620TB	7314150320509	350	10	1	187
SBE-8810TB	7314150320530	350	10	1	187
SBE-8820TB	7314150320547	350	10	1	187
SBE-8915TB	7314150320585	350	10	1	187
SBE-8920TB	7314150320592	350	10	1	187
SBE-8925TB	7314150320608	350	10	1	187
SBE-8930TB	7314150320622	350	10	1	187
SBE-8940TB	7314150320639	350	10	1	187
SBS20-10	7314153009142	366	10	1	41
SBS20-11	7314153009159	366	10	1	41
SBS20-12	7314153009166	366	10	1	41
SBS20-13	7314153009173	366	10	1	41
SBS20-14	7314153009180	366	10	1	41
SBS20-15	7314153009197	366	10	1	41
SBS20-16	7314153009203	366	10	1	41
SBS20-17	7314153009210	366	10	1	41
SBS20-18	7314153009227	366	10	1	41
SBS20-19	7314153009234	366	10	1	41
SBS20-20	7314153009241	366	10	1	41
SBS20-21	7314153009258	366	10	1	41
SBS20-22	7314153009265	366	10	1	41
SBS20-24	7314153009272	366	10	1	41
SBS20-27	7314153009289	366	10	1	41
SBS20-30	7314153009296	366	10	1	41
SBS20-32	7314153009302	366	10	1	41
SBS20-6	7314153009104	366	10	1	41
SBS20-7	7314153009111	366	10	1	41
SBS20-8	7314153009128	366	10	1	41
SBS20-9	7314153009135	366	10	1	41
SBS61	7314153009661	354	20	1	69
SBS61S	7314150179886	354	20	1	69
SBS705	7314153012968	354	15	1	77
SBS71-16	7314150127245	312	10	1	283
SBS71-21	7314150127252	312	10	1	283
SBS750	7314153012883	354	20	10	79
SBS81	7314153009937	354	20	5	90
SBS82	7314153009944	354	20	1	90
SBS87	7314153009968	354	15	1	87
SBS87S	7314153009951	354	15	1	87
SBSL25	7314153015853	354	25	5	74
SC127	7314150121984	334	35	10	518
SC127S	7314150121991	334	35	10	518
SC127V	7314150121847	334	45	5	444
SC140	7314150122004	334	35	10	518
SC140C	7314150122011	334	35	10	518

SE-15-30-23

	CUENTA	SUBGRUPO			
SE-15-30-23	7311518029845	316	10	5	568
SE-15-32	7311518249168	316	10	5	568
SE-15-36	7311518141202	316	10	5	568
SE-15-36-23	7311518258276	316	10	5	568
SE-16-21	7311518029807	316	10	5	568
SE-16-21-23	7311518273934	316	10	5	568
SH-407	7314150389827	358	10	12	532
SH-427-700	7314150349074	358	10	10	533
SH-428-700	7314150349081	358	10	10	533
SH-485W	7314150358021	358	10	1	531
SH-485W-PLATES	7314150358038	358	10	1	531
SH-486-493-495	7314150349098	358	10	10	533
SH-486F493F495F	7314150349104	358	10	10	533
SH-486W	7314150358014	358	10	1	532
SH-488-2000	7314150346912	358	10	10	532
SH-488-34	7314150349036	358	10	10	532
SH-488-56	7314150349043	358	10	10	533
SH-488F-2000	7314150346950	358	10	10	533
SH-488F-34	7314150349050	358	10	1	533
SH-488F-56	7314150349067	358	10	1	533
SH-491-34	7314150374298	358	10	12	532
SH-491-56	7314150374304	358	10	12	532
SH-FCP-860	7311518324421	326	15	1	539
SH-FCS-810	7311518140540	326	15	1	539
SH-FCS-860	7311518140557	326	15	1	539
SH-FGS-1.8-810	7311518327828	326	15	1	539
SH-FGS-600	7311518140649	326	15	1	539
SH-FGS-700	7311518140656	326	15	12	539
SH-FGS-800	7311518140663	326	15	1	539
SH-HFGPS-400FG	7311518282301	326	15	1	539
SH-HGPS-360	7311518140618	326	15	12	539
SH-HGPS-380	7311518140625	326	15	1	539
SH-HGPS-400	7311518207618	326	15	1	539
SH-HUS-380	7311518140502	326	15	1	539
SH-HUS-500	7311518140519	326	15	1	539
SH-HUS-650	7311518140526	326	15	1	539
SH-MCS-800	7311518140595	326	15	1	539
SH-MES-900	7311518140601	326	15	12	539
SH-MES-900FG	7311518282318	326	15	12	539
SH-MES-F-900	7311518141554	326	15	12	539
SH-PAGS-900	7311518327866	320	20	1	539
SH-PAGS-900FG	7311518326944	320	20	1	539
SH-SUS-800	7311518140809	326	15	12	539
SHARP-INS	7314150197897	330	10	100	506
SHARP-X	7311518264895	326	25	10	570
SHARP-X-DISP	7311518264901	326	25	1	570
SL24	7314150128389	354	25	1	74
SL25	7314150313422	354	25	20	74
SL25AF	7314150180141	354	25	1	74
SL25L	7314150256570	354	25	10	74
SL34	7314150409181	354	25	6	84
SLX 17	73141503015785	354	25	1	100
SLX 17AF	7314150137558	354	25	1	100
SLX17-CASE	7314150321254	354	25	1	112
SP120	7314150312474	354	10	1	88
SP120XL	7314150313594	354	10	1	88
SPAR-CASE-A4	7314150263523	354	25	1	112
SPAR-CASE-A5	7314150263530	354	25	1	112
SPAR-CASE-A6	7314150263547	354	25	1	112
SPAR-CASE-A7	7314150263554	354	25	1	112
SQZ-MINI	7314150186280	334	10	24	521
SQZ-MINI-BLADE	7314150190348	334	15	1	521
SQZ150003	7314153013477	334	10	6	520
SQZ150003-HSBL	7314153015389	334	15	6	520
SQZ150003-SBL	7314153015372	334	15	1	520
SR1000-E	7314150302918	336	15	20	484
SR1000-MM	7314150302857	336	15	20	484
SR150-E	7314150302864	336	15	12	484
SR150-MM	7314150302819	336	15	12	484
SR200-E	7314150302871	336	15	12	484
SR200-MM	7314150302826	336	15	12	484
SR300-E	7314150302888	336	15	12	484
SR300-MM	7314150302833	336	15	12	484
SR600-E	7314150302901	336	15	20	484
SR600-MM	7314150302840	336	15	20	484
SS001-100	7314150404384	348	70	1	468
SS001-150	7314150404377	348	70	1	468
SS001-200	7314150404391	348	70	1	468
SS001-250	7314150404407	348	70	1	468
SS001-300	7314150404414	348	70	1	468
SS001-375	7314150404421	348	70	1	468
SS001-450	7314150404438	348	70	1	468
SS001-600	7314150404445	348	70	1	468
SS002-10	7314150404483	348	70	1	468
SS002-11	7314150404490	348	70	1	468
SS002-12	7314150404506	348	70	1	468
SS002-13	7314150404513	348	70	1	468
SS002-14	7314150404520	348	70	1	468
SS002-15	7314150404537	348	70	1	468
SS002-16	7314150404551	348	70	1	468
SS002-17	7314150404568	348	70	1	468
SS002-19	7314150404575	348	70	1	468
SS002-21	7314150404582	348	70	1	468
SS002-22	7314150404599	348	70	1	468
SS002-24	7314150404605	348	70	1	468
SS002-27	7314150404612	348	70	1	468
SS002-32	7314150404629	348	70	1	468
SS002-6	7314150404469	348	70	1	468

	CUENTA	SUBGRUPO			
SS002-6-2	7314150407903	348	70	1	468
SS002-8	7314150404476	348	70	1	468
SS002-9-2	7314150407910	348	70	1	468
SS003-10	7314150404643	348	70	1	468
SS003-11	7314150404650	348	70	1	468
SS003-12	7314150404667	348	70	1	468
SS003-14	7314150404681	348	70	1	468
SS003-16	7314150404704	348	70	1	468
SS003-18	7314150404711	348	70	1	468
SS003-20	7314150404728	348	70	1	468
SS003-22	7314150404735	348	70	1	468
SS003-24	7314150404742	348	70	1	468
SS003-25	7314150404759	348	70	1	468
SS003-26	7314150404766	348	70	1	468
SS003-28	7314150404773	348	70	1	468
SS003-30	7314150404780	348	70	1	468
SS003-8	7314150404636	348	70	1	468
SS011-0507	7314150404797	348	70	1	468
SS011-0607	7314150404803	348	70	1	468
SS011-0809	7314150404810	348	70	1	468
SS011-0810	7314150404827	348	70	1	468
SS011-0911	7314150404834	348	70	1	468
SS011-1012	7314150404858	348	70	1	468
SS011-1214	7314150404865	348	70	1	468
SS011-1417	7314150404872	348	70	1	468
SS011-1618	7314150404889	348	70	1	468
SS011-1719	7314150404896	348	70	1	468
SS011-1722	7314150404902	348	70	1	468
SS011-2224	7314150404919	348	70	1	468
SS011-2427	7314150404926	348	70	1	468
SS011-2430	7314150404940	348	70	1	468
SS011-3032	7314150404957	348	70	1	468
SS210-10	7314150405343	348	70	1	469
SS210-11	7314150405350	348	70	1	469
SS210-12	7314150405367	348	70	1	469
SS210-13	7314150405374	348	70	1	469
SS210-14	7314150405381	348	70	1	469
SS210-4	7314150405268	348	70	1	469
SS210-4.5	7314150405275	348	70	1	469
SS210-5	7314150405282	348	70	1	469
SS210-5.5	7314150405299	348	70	1	469
SS210-6	7314150405305	348	70	1	469
SS210-7	7314150405312	348	70	1	469
SS210-8	7314150405329	348	70	1	469
SS210-9	7314150405336	348	70	1	469
SS220-10	7314150404995	348	70	1	469
SS220-11	7314150405008	348	70	1	469
SS220-12	7314150405022	348	70	1	469
SS220-13	7314150405039	348	70	1	469
SS220-14	7314150405053	348	70	1	469
SS220-15	7314150405060	348	70	1	469
SS220-16	7314150405077	348	70	1	469
SS220-17	7314150405084	348	70	1	469
SS220-18	7314150405091	348	70	1	469
SS220-19	7314150405114	348	70	1	469
SS220-20	7314150405121	348	70	1	469
SS220-21	7314150405138	348	70	1	469
SS220-22	7314150405145	348	70	1	469
SS220-23	7314150405152	348	70	1	469
SS220-24	7314150405176	348	70	1	469
SS220-25	7314150405183	348	70	1	469
SS220-26	7314150405190	348	70	1	469
SS220-27	7314150405206	348	70	1	469
SS220-28	7314150405213	348	70	1	469
SS220-29	7314150405220	348	70	1	469
SS220-30	7314150405237	348	70	1	469
SS220-31	7314150405244	348	70	1	469
SS220-32	7314150405251	348	70	1	469
SS220-8	7314150404964	348	70	1	469
SS220-9	7314150404988	348	70	1	469
SS224-17	7314150405398	348	70	1	469
SS224-19	7314150405404	348	70	1	469
SS224-22	7314150405411	348	70	1	469
SS224-24	7314150405428	348	70	1	469
SS224-27	7314150405435	348	70	1	469
SS224-30	7314150405442	348	70	1	469
SS224-32	7314150405459	348	70	1	469
SS224-34	7314150405466	348	70	1	469
SS224-36	7314150405473	348	70	1	469
SS224-41	7314150405480	348	70	1	469
SS224-46	7314150405497	348	70	1	469
SS224-50	7314150405503	348	70	1	469
SS224-55	7314150405510	348	70	1	469
SS224-60	7314150405527	348	70	1	469
SS224-65	7314150405534	348	70	1	469
SS234-16-100	7314150405572	348	70	1	469
SS234-16-200	7314150405589	348	70	1	469
SS234-16-250	7314150405602	348	70	1	469
SS234-24-100	7314150405619	348	70	1	469
SS234-24-200	7314150405626	348	70	1	469
SS234-24-250	7314150405633	34			



CUENTA SUBGRUPO



SS242-16-245	7314150405541	348	70	1	470
SS242-24-320	7314150405565	348	70	1	470
SS243-08	7314150405688	348	70	1	469
SS243-16	7314150405671	348	70	1	469
SS243-24	7314150405695	348	70	1	469
SS324-1.5	7314150405732	348	70	1	470
SS324-10	7314150405824	348	70	1	471
SS324-2	7314150405749	348	70	1	470
SS324-2.5	7314150405756	348	70	1	470
SS324-3	7314150405763	348	70	1	471
SS324-4	7314150405770	348	70	1	471
SS324-5	7314150405787	348	70	1	471
SS324-6	7314150405794	348	70	1	471
SS324-8	7314150405817	348	70	1	471
SS325-10	7314150405886	348	70	1	471
SS325-12	7314150405879	348	70	1	471
SS325-2.5	7314150405909	348	70	1	471
SS325-3	7314150405862	348	70	1	471
SS325-3.5	7314150405923	348	70	1	471
SS325-4	7314150405848	348	70	1	471
SS325-4.5	7314150405930	348	70	1	471
SS325-5	7314150405893	348	70	1	471
SS325-6	7314150405855	348	70	1	471
SS325-7	7314150405916	348	70	1	471
SS325-8	7314150405831	348	70	1	471
SS400-160	7314150405978	348	70	1	472
SS400-180	7314150405985	348	70	1	472
SS400-200	7314150405992	348	70	1	472
SS402-160	7314150406005	348	70	1	472
SS402-200	7314150406012	348	70	1	472
SS406-160	7314150406029	348	70	1	472
SS406-200	7314150406036	348	70	1	472
SS410-250	7314150406043	348	70	1	472
SS410-300	7314150406050	348	70	1	472
SS412-200	7314150406067	348	70	1	472
SS415-225	7314150406074	348	70	1	472
SS502-1000-FB	7314150406081	348	70	1	472
SS502-1500-FB	7314150406098	348	70	1	472
SS502-2000-FB	7314150406104	348	70	1	472
SS502-2500-FB	7314150406111	348	70	1	472
SS502-3000-FB	7314150406128	348	70	1	472
SS502-3600-FB	7314150406135	348	70	1	472
SS506-1100-FB	7314150406197	348	70	1	472
SS506-200-FB	7314150406142	348	70	1	472
SS506-300-FB	7314150406159	348	70	1	472
SS506-500-FB	7314150406166	348	70	1	472
SS506-700-FB	7314150406173	348	70	1	472
SS506-900-FB	7314150406180	348	70	1	472
SS603-15-500	7314150406203	348	70	1	472
SS603-19-500	7314150406210	348	70	1	472
SS603-20-500	7314150406227	348	70	1	472
SS603-23-500	7314150406234	348	70	1	472
SS603-23-800	7314150406258	348	70	1	472
SS603-25-600	7314150406241	348	70	1	472
SS603-30-1000	7314150406265	348	70	1	472
SS610-16-160	7314150406272	348	70	1	472
SS610-18-200	7314150406289	348	70	1	472
SS610-24-300	7314150406296	348	70	1	472
SS610-25-400	7314150406302	348	70	1	472
SS610-30-500	7314150406319	348	70	1	472
SUC-0.7-450	7314150342082	326	15	4	539
SUC-0.9-600	7314150342105	326	15	4	539
SUC-1.0-710	7314150342068	326	15	4	539
SUC-1.7-800	7314150342051	326	15	4	539
SUP-20-LAM	7311518258351	330	10	4	504
SUS-2.0-800	7311518123451	326	15	4	538
TAH08-10	7314150305087	348	45	1	422
TAH08-11	7314150305094	348	45	1	422
TAH08-12	7314150305100	348	45	1	422
TAH08-13	7314150305117	348	45	1	422
TAH08-5.5	7314150305032	348	45	1	422
TAH08-6	7314150305049	348	45	1	422
TAH08-7	7314150305056	348	45	1	422
TAH08-8	7314150305063	348	45	1	422
TAH08-9	7314150305070	348	45	1	422
TAH08-H3	7314150305124	348	45	1	423
TAH08-H4	7314150305131	348	45	1	423
TAH08-H5	7314150305148	348	45	1	423
TAH08-H6	7314150305155	348	45	1	423
TAH08-H8	7314150305162	348	45	1	423
TAH08-PH1	7314150305179	348	45	1	423
TAH08-PH2	7314150305186	348	45	1	423
TAH08-PH3	7314150305193	348	45	1	423
TAH08-T10	7314150305223	348	45	1	423
TAH08-T15	7314150305230	348	45	1	423
TAH08-T20	7314150305247	348	45	1	423
TAH08-T25	7314150305254	348	45	1	423
TAH08-T27	7314150305261	348	45	1	423
TAH08-T30	7314150305278	348	45	1	423
TAH08-T40	7314150305285	348	45	1	423
TAH08-T8	7314150305209	348	45	1	423
TAH08-T9	7314150305216	348	45	1	423
TAH1-143-12-1-2	7314150307548	348	45	1	428
TAH1-210-06-2-2	7314150307555	348	45	1	428
TAH1-230-06-2-2	7314150307562	348	45	1	428
TAH111M-10	7314150308538	348	45	1	421
TAH111M-11	7314150308545	348	45	1	421
TAH111M-12	7314150308552	348	45	1	421



CUENTA SUBGRUPO



TAH111M-13	7314150308569	348	45	1	421
TAH111M-14	7314150308576	348	45	1	421
TAH111M-15	7314150308583	348	45	1	421
TAH111M-16	7314150308590	348	45	1	421
TAH111M-17	7314150308606	348	45	1	421
TAH111M-18	7314150308613	348	45	1	421
TAH111M-19	7314150308620	348	45	1	421
TAH111M-20	7314150308637	348	45	1	421
TAH111M-21	7314150308644	348	45	1	421
TAH111M-22	7314150308651	348	45	1	421
TAH111M-23	7314150308668	348	45	1	421
TAH111M-24	7314150308675	348	45	1	421
TAH111M-25	7314150399611	348	45	1	421
TAH111M-27	7314150308682	348	45	1	421
TAH111M-30	7314150308699	348	45	1	421
TAH111M-32	7314150308705	348	45	1	421
TAH111M-34	7314150308712	348	45	1	421
TAH111M-36	7314150308729	348	45	1	421
TAH111M-41	7314150308736	348	45	1	421
TAH111M-46	7314150308743	348	45	1	421
TAH111M-50	7314150308750	348	45	1	421
TAH111M-55	7314150411573	348	45	1	421
TAH111M-6	7314150308491	348	45	1	421
TAH111M-7	7314150308507	348	45	1	421
TAH111M-8	7314150308514	348	45	1	421
TAH111M-85	7314150362356	348	45	1	421
TAH111M-9	7314150308521	348	45	1	421
TAH111Z-1	7314150343362	348	45	1	421
TAH111Z-1.1/16	7314150343379	348	45	1	421
TAH111Z-1.1/4	7314150343386	348	45	1	421
TAH111Z-1.1/8	7314150343393	348	45	1	421
TAH111Z-1.5/16	7314150343409	348	45	1	421
TAH111Z-1/2	7314150343461	348	45	1	421
TAH111Z-1/4	7314150343508	348	45	1	421
TAH111Z-11/16	7314150343522	348	45	1	421
TAH111Z-13/16	7314150343539	348	45	1	421
TAH111Z-15/16	7314150343546	348	45	1	421
TAH111Z-3/4	7314150343553	348	45	1	421
TAH111Z-3/8	7314150343560	348	45	1	421
TAH111Z-5/16	7314150343591	348	45	1	421
TAH111Z-5/8	7314150343607	348	45	1	421
TAH111Z-7/16	7314150343614	348	45	1	421
TAH111Z-7/8	7314150343621	348	45	1	421
TAH111Z-9/16	7314150343638	348	45	1	421
TAH150-1/2H/P	7314150307760	348	45	1	430
TAH1177-SCRIBE	7314150307777	348	45	1	430
TAH140	7314150344475	348	45	1	422
TAH141	7314150339433	348	45	1	422
TAH1410	7314150344543	348	45	1	422
TAH142	7314150339440	348	45	1	422
TAH1420	7314150344550	348	45	1	422
TAH143	7314150344482	348	45	1	422
TAH1544	7314150307746	348	45	1	431
TAH16-H10	7314150306176	348	45	1	424
TAH16-H12	7314150306183	348	45	1	424
TAH16-H14	7314150306190	348	45	1	424
TAH16-H17	7314150306206	348	45	1	424
TAH16-H19	7314150306213	348	45	1	424
TAH16-H4	7314150306121	348	45	1	424
TAH16-H5	7314150306138	348	45	1	424
TAH16-H6	7314150306145	348	45	1	424
TAH16-H7	7314150306152	348	45	1	424
TAH16-H8	7314150306169	348	45	1	424
TAH16-T30	7314150306220	348	45	1	424
TAH16-T40	7314150306237	348	45	1	424
TAH16-T45	7314150306244	348	45	1	424
TAH16-T50	7314150306251	348	45	1	424
TAH16-T55	7314150306268	348	45	1	424
TAH16-T60	7314150306275	348	45	1	424
TAH16B-1	7314150306077	348	45	1	423
TAH16B-1.1/16	7314150306084	348	45	1	423
TAH16B-1.1/4	7314150306107	348	45	1	423
TAH16B-1.1/8	7314150306114	348	45	1	423
TAH16B-1/2	7314150305995	348	45	1	423
TAH16B-10	7314150305629	348	45	1	423
TAH16B-11	7314150305636	348	45	1	423
TAH16B-11/16	7314150306022	348	45	1	423
TAH16B-12	7314150305643	348	45	1	423
TAH16B-13	7314150305650	348	45	1	423
TAH16B-13/16	7314150306046	348	45	1	423
TAH16B-14	7314150305667	348	45	1	423
TAH16B-15	7314150305674	348	45	1	423
TAH16B-15/16	7314150306060	348	45	1	423

TAH16H-1/2



CUENTA SUBGRUPO



TAH16H-1/2	7314150306329	348	45	1	424
TAH16H-1/4	7314150306282	348	45	1	424
TAH16H-3/8	7314150306305	348	45	1	424
TAH16H-5/16	7314150306299	348	45	1	424
TAH16H-5/8	7314150306343	348	45	1	424
TAH16H-7/16	7314150306312	348	45	1	424
TAH16H-9/16	7314150306336	348	45	1	424
TAH1949M-10-11	7314150308866	348	45	1	421
TAH1949M-12-14	7314150308873	348	45	1	421
TAH1949M-14-17	7314150308880	348	45	1	421
TAH1949M-19-22	7314150308897	348	45	1	421
TAH1949M-24-27	7314150308903	348	45	1	421
TAH1949M-8-9	7314150308859	348	45	1	421
TAH1RM-17	7314150352210	348	45	1	421
TAH1RM-19	7314150352227	348	45	1	421
TAH1RM-24	7314150352234	348	45	1	421
TAH1RM-30	7314150352241	348	45	1	421
TAH2047-0-8-4	7314150308088	348	45	1	426
TAH2047PR-1-2	7314150308095	348	45	1	426
TAH2101G-125	7314150344581	348	45	1	427
TAH2101G-125C	7314150344598	348	45	1	427
TAH2101G-140	7314150307869	348	45	1	427
TAH2101G-140C	7314150344611	348	45	1	427
TAH2101G-160	7314150307876	348	45	1	427
TAH2101G-160C	7314150344635	348	45	1	427
TAH2101G-180	7314150345106	348	45	1	427
TAH2101G-180C	7314150344666	348	45	1	427
TAH21HDG-200	7314150345649	348	45	1	427
TAH21HDG-200C	7314150345656	348	45	1	427
TAH2223G-150	7314150411597	348	45	1	427
TAH225-PLUS	7314150319978	348	45	1	427
TAH2427G-200	7314150307883	348	45	1	428
TAH2430G-200	7314150307906	348	45	1	427
TAH2484-30	7314150307968	348	45	1	430
TAH2487	7314150320028	348	45	1	432
TAH24B-27	7314150309306	348	45	1	424
TAH24B-30	7314150309313	348	45	1	424
TAH24B-32	7314150309320	348	45	1	424
TAH24B-36	7314150309337	348	45	1	424
TAH24B-38	7314150309344	348	45	1	424
TAH24B-41	7314150309351	348	45	1	424
TAH24B-46	7314150309368	348	45	1	424
TAH24B-50	7314150309375	348	45	1	424
TAH2509	7314150307753	348	45	1	431
TAH2535F2	7314150307784	348	45	1	431
TAH2628G-160	7314150307913	348	45	1	427
TAH2628G-180	7314150307920	348	45	1	427
TAH2820EF2	7314150307708	348	45	1	429
TAH2855	7314150307937	348	45	1	428
TAH2951-250	7314150432400	348	45	1	427
TAH2958-200	7314150320219	348	45	1	428
TAH2958-250	7314150307944	348	45	1	428
TAH2970G-200	7314150343331	348	45	1	427
TAH317	7314150319985	348	45	1	428
TAH320	7314150319992	348	45	1	428
TAH325	7314150320004	348	45	1	428
TAH3625PU-50	7314150307579	348	45	1	429
TAH3625W-35	7314150307609	348	45	1	429
TAH3640-250-C	7314150307975	348	45	1	430
TAH3683	7314150352258	348	45	1	430
TAH3734BM-10	7314150308057	348	45	1	430
TAH3734BM-2	7314150343348	348	45	1	430
TAH3734BM-3	7314150307982	348	45	1	430
TAH3734BM-4	7314150308019	348	45	1	430
TAH3734BM-5	7314150308026	348	45	1	430
TAH3734BM-6	7314150308033	348	45	1	430
TAH3734BM-8	7314150308040	348	45	1	430
TAH3755BM-4	7314150308064	348	45	1	430
TAH380-10	7314150307845	348	45	1	422
TAH380-14	7314150320172	348	45	1	422
TAH380-18	7314150307852	348	45	1	422
TAH380-24	7314150343317	348	45	1	422
TAH420SH-80-160	7314150411610	348	45	1	432
TAH440007000	7314150343355	348	45	1	430
TAH466-250	7314150307791	348	45	1	430
TAH479-16	7314150307586	348	45	1	429
TAH479-32	7314150307593	348	45	1	429
TAH481-300	7314150307616	348	45	1	429
TAH484-1500	7314150307623	348	45	1	429
TAH484-2000	7314150319916	348	45	1	429
TAH486F-700	7314150307658	348	45	1	430
TAH489-1100	7314150307647	348	45	1	429
TAH489-1800	7314150343294	348	45	1	429
TAH489-2700	7314150319923	348	45	1	429
TAH489-3600	7314150307654	348	45	1	429
TAH489-5400	7314150319930	348	45	1	429
TAH52	7314150339730	348	45	1	429
TAH6950	7314150309054	348	45	1	423
TAH6956-1	7314150309061	348	45	1	423
TAH6958B-1	7314150309078	348	45	1	422
TAH6960	7314150305315	348	45	1	422
TAH6961	7314150305322	348	45	1	422
TAH6962	7314150305339	348	45	1	422
TAH6962L	7314150305346	348	45	1	422
TAH6966	7314150305353	348	45	1	422
TAH6M-10-11	7314150370665	348	45	1	422
TAH6M-12-13	7314150370672	348	45	1	422
TAH6M-14-15	7314150400393	348	45	1	422



CUENTA SUBGRUPO



TAH6M-16-17	7314150400409	348	45	1	422
TAH6M-17-19	7314150370689	348	45	1	422
TAH6M-18-19	7314150400416	348	45	1	422
TAH6M-20-22	7314150400423	348	45	1	422
TAH6M-24-27	7314150400430	348	45	1	422
TAH6M-30-32	7314150400447	348	45	1	422
TAH6M-8-9	7314150400386	348	45	1	422
TAH7435-100	7314150327249	348	45	1	431
TAH7444SG-M-36	7314150308934	348	45	1	421
TAH7444SG-M-41	7314150308941	348	45	1	421
TAH7444SG-M-46	7314150308958	348	45	1	421
TAH7444SG-M-50	7314150308965	348	45	1	421
TAH7444SG-M-55	7314150308972	348	45	1	421
TAH7445-100A-1	7314150327546	348	45	1	431
TAH7452-2	7314150302543	348	45	1	432
TAH7455-300-1	7314150309412	348	45	1	431
TAH782-U	7314150339747	348	45	1	429
TAH8070	7314150347025	348	45	1	421
TAH8071	7314150347032	348	45	1	421
TAH8072	7314150307487	348	45	1	421
TAH8073	7314150319831	348	45	1	421
TAH8074	7314150319848	348	45	1	421
TAH8075	7314150307500	348	45	1	421
TAH8150-1/2	7314150309283	348	45	1	424
TAH8158B-1	7314150309290	348	45	1	423
TAH8160	7314150306367	348	45	1	423
TAH8162	7314150306374	348	45	1	423
TAH8166	7314150306381	348	45	1	424
TAH8224	7314150307951	348	45	1	427
TAH84-PODGER	7314150312221	348	45	1	421
TAH8950N/A	7314150309382	348	45	1	424
TAH8953	7314150309399	348	45	1	424
TAH8961	7314150309405	348	45	1	424
TAH9045-B-250	7314150411634	348	45	1	431
TAH9048-250	7314150411627	348	45	1	431
TAH9070	7314150307517	348	45	1	421
TAH9072	7314150307524	348	45	1	421
TAHBE-8020L	7314150308101	348	45	1	425
TAHBE-8030	7314150308118	348	45	1	425
TAHBE-8040	7314150308125	348	45	1	425
TAHBE-8040S	7314150308132	348	45	1	426
TAHBE-8050S	7314150308149	348	45	1	426
TAHBE-8155	7314150308156	348	45	1	425
TAHBE-8220S	7314150308163	348	45	1	426
TAHBE-8241	7314150308217	348	45	1	425
TAHBE-8252	7314150308224	348	45	1	425
TAHBE-8255S	7314150320226	348	45	1	426
TAHBE-8257	7314150308231	348	45	1	425
TAHBE-8258	7314150308248	348	45	1	425
TAHBE-8260	7314150308255	348	45	1	425
TAHBE-8350	7314150308262	348	45	1	425
TAHBE-8602	7314150308279	348	45	1	425
TAHBE-8610	7314150308286	348	45	1	425
TAHBE-8610S	7314150308293	348	45	1	426
TAHBE-8611	7314150308309	348	45	1	425
TAHBE-8620	7314150308316	348	45	1	425
TAHBE-8620L	7314150308323	348	45	1	425
TAHBE-8620S	7314150308330	348	45	1	426
TAHBE-8623	7314150308347	348	45	1	425
TAHBE-8624	7314150308354	348	45	1	425
TAHBE-8630	7314150308361	348	45	1	425
TAHBE-8630S	7314150320233	348	45	1	426
TAHBE-8640S	7314150320240	348	45	1	426
TAHBE-8810	7314150308378	348	45	1	425
TAHBE-8820	7314150308385	348	45	1	425
TAHBE-8830	7314150308392	348	45	1	425
TAHBE-8910	7314150343713	348	45	1	426
TAHBE-8910S	7314150343799	348	45	1	426
TAHBE-8915	7314150343744	348	45	1	426
TAHBE-8915S	7314150343805	348	45	1	426
TAHBE-8920	7314150343751	348	45	1	426
TAHBE-8920S	7314150343812	348	45	1	426
TAHBE-8925	7314150343768	348	45	1	426
TAHBE-8925S	7314150343829	348	45	1	426
TAHBE-8930	7314150343775	348	45	1	426
TAHBE-8930S	7314150343836	348	45	1	426
TAHBE-9777B	7314150307685	348	45	1	426
TAHBE-9787	7314150307692	348	45	1	426
TAHBE64520	7314150307821	348	45	1	432
TAHBFRLL11	7314150307739	348	45	1	432
TAHBOD5400	7314150339457	348	45	1	432
TAHBOD5450	7314150339464	348	45	1	432
TAHCS300	7314150411603	348	45		



TAS14S09	7314150423217	360	20	1	121
TAW12340	7314150274963	360	20	1	119
TAW1412M	7314150423156	360	20	1	119
TAW1430M	7314150422289	360	20	1	119
TAW14340	7314150340842	360	20	1	119
TAW24800	7314150368297	360	20	1	119
TAW34800	7314150285471	360	20	1	119
TAW38135	7314150274956	360	20	1	119
TAW912M	7314150423163	360	20	1	119
TAW9135	7314150340859	360	20	1	119
TAW930M	7314150422319	360	20	1	119
TAWM12340	7314150274925	360	20	1	119
TAWM1412M	7314150423149	360	20	1	120
TAWM1430M	7314150422265	360	20	1	120
TAWM14340	7314150340835	360	20	1	119
TAWM24800	7314150368280	360	20	1	119
TAWM34800	7314150274932	360	20	1	119
TAWM38135	7314150274918	360	20	1	119
TAWM912M	7314150423132	360	20	1	120
TAWM9135	7314150340828	360	20	1	119
TAWM930M	7314150422241	360	20	1	120
TEA1100	7314150423170	360	35	1	123
TEA350	7314150422210	360	35	1	123
TL 0-SA	7314150109593	340	80	1	582
TL 00-SA	7314150109579	340	80	1	582
TL 00-SA-ET	7311518279219	340	80	1	582
TL 00-SA-SL	7314150274928	340	80	5	584
TL 00B-SA	7314150109555	340	80	1	582
TL 00CFR-SA	7314150115402	340	80	1	586
TL 00D-SA	7314150109562	340	80	1	582
TL 009-SA	7314150109586	340	80	1	582
TL 1-SA	7314150109647	340	80	1	582
TL 1-SA-SL	7314150115235	340	80	5	584
TL 10G-SA	7314150109609	340	80	1	582
TL 124-SA	7314150110018	340	80	1	585
TL 15AP	7314150109630	340	80	1	582
TL 2-SA	7314150110117	340	80	1	583
TL 2-SA-SL	7314150115242	340	80	5	584
TL 231-SA	7314150110087	340	80	1	585
TL 249 ACF	7314150115174	340	80	1	587
TL 249CFR-SA	7314150115143	340	80	1	586
TL 259 ACF	7314150115167	340	80	1	587
TL 259 CFR-SA	7314150115150	340	80	1	586
TL 269CF-SA	7314150110735	340	80	1	587
TL 2A ACF	7314150115457	340	80	1	587
TL 2A-SA	7314150110100	340	80	1	583
TL 2A-SA-SL	7314150115259	340	80	5	584
TL 2AB-SA	7314150110094	340	80	1	582
TL 2ACFR-SA	7314150115419	340	80	1	586
TL 2AX-SA	7314150110025	340	80	1	584
TL 3-SA	7314150110162	340	80	1	583
TL 3-SA-ET	7311518279356	340	80	1	582
TL 3-SA-SL	7314150115266	340	80	5	584
TL 3C-SA	7314150110148	340	80	1	583
TL 3C-SA-SL	7314150115273	340	80	5	584
TL 3C-TA	7314150110155	340	80	1	583
TL 4-SA	7314150110186	340	80	1	583
TL 4-SA-SL	7314150115280	340	80	5	584
TL 475-SA	7314150110032	340	80	1	585
TL 5-SA	7314150110247	340	80	1	583
TL 5-SA-SL	7314150115297	340	80	5	585
TL 5-TA	7314150110254	340	80	1	583
TL 51S-SA	7314150110209	340	80	1	583
TL 577-SA	7314150110421	340	80	1	586
TL 578-SA	7314150110438	340	80	1	586
TL 582-SA	7314150110452	340	80	1	586
TL 5A-SA	7314150110216	340	80	1	583
TL 5A-SA-SL	7314150115303	340	80	5	584
TL 5ACF	7314150115464	340	80	1	587
TL 5B-SA	7314150110223	340	80	1	583
TL 5CFR-SA	7314150115426	340	80	1	586
TL 648-SA	7314150110049	340	80	1	585
TL 649-SA	7314150110063	340	80	1	585
TL 65A-SA	7314150110278	340	80	1	583
TL 7-SA	7314150110292	340	80	1	584
TL 7-SA-SL	7314150115310	340	80	5	585
TL 7A-SA	7314150110285	340	80	1	584
TL 7A-SA-SL	7314150115327	340	80	5	585
TL 7ACF	7314150115471	340	80	1	587
TL 7CFR-SA	7314150115433	340	80	1	586
TLAA-S	7314150110544	340	80	1	586
TLAA-SA	7314150110551	340	80	1	586
TLAA-SA-SL	7314150115334	340	80	5	585
TLAA-TA	7314150110575	340	80	1	586
TLAC-SA-SL	7314150115341	340	80	5	585
TLMM-SA-SL	7314150115365	340	80	5	585
TL SM 103-SA	7314150110773	340	80	1	587
TL SM 104-SA	7314150110780	340	80	1	587
TL SM 105-SA	7314150110797	340	80	1	587
TL SM 107-SA	7314150110810	340	80	1	587
TL SM 108-SA	7314150110827	340	80	1	587
TL SM 109-SA	7314150110834	340	80	1	587
TL SM 110-SA	7314150110841	340	80	1	588
TL SM 111-SA	7314150110858	340	80	1	588
TL SM 115-SA	7314150110896	340	80	1	588
TL SM 117-SA	7314150110919	340	80	1	588
TL SS-SA	7314150109937	340	80	1	584
TL SS-SA-SL	7314150115358	340	80	5	585



TRX 8180	7314150112272	340	65	5	581
TSS120	7314150347063	360	25	1	121
TSS600	7314150346417	360	25	1	121
W-S-1.5	7311518140816	326	15	4	539
W-S-2.0	7311518140823	326	15	4	539
W-S-2.5	7311518140830	326	15	4	539
W-T-2.0	7311518140847	326	15	4	539
WBB400	7314150315215	358	20	10	550
WBB500	7314150315222	358	20	10	550
WBB600	7314150315239	358	20	10	550
WBB700	7314150315246	358	20	6	550
WBB800	7314150340972	358	20	6	550
WBF380	7314150315253	358	20	12	550
WBMF190	7314150315260	358	20	24	550
WBP300	7314150315161	358	20	20	550
WBP500	7314150315178	358	20	12	550
WBP625	7314150315185	358	20	12	550
WBP710	7314150315192	358	20	10	550
WBP900	7314150315208	358	20	6	550
WC-HOL	7314150333158	364	15	1	513
WPCU2S	7314150422517	360	50	1	130
WPCU2S-AUS	7314150422555	360	50	1	130
WPCU2S-UK	7314150422524	360	50	1	130
WPCU2S-US	7314150422548	360	50	1	130
WPTC-100	7314150422487	360	50	1	130
WPTC-15	7314150422456	360	50	1	130
WPTC-200	7314150422494	360	50	1	130
WPTC-25	7314150422463	360	50	1	130
WPTC-300	7314150422500	360	50	1	130
WPTC-5	7314150422449	360	50	1	130
WPTC-60	7314150422470	360	50	1	130
WR1	7314150167425	336	15	50	483
WR1-MM	7314150220069	336	15	50	483
WR2	7314150167432	336	15	25	483
WR2-12	7314150185627	336	15	25	483
WR2-MM	7314150220038	336	15	25	483
ZHVIDEOBAT	8414909180244	312	30	1	332
ZHVIDEOCHA	8414909180237	312	30	1	332



Contacto

Argentina

A.M. de Justo 1750 3° A
C1107AFJ - Capital Federal
Buenos Aires
Tel : +54 (11) 4313-1004
Fax : +54 (11) 4893-3553

Australia

SNA E Australia
43 Enterprise Circuit
Prestons NSW 2170
Tel: +61 (0) 2 8738 1400
Fax: +61 (0) 2 8783 0684

Беларусь

220075, Минск,
ул. Селицкого, 8а
Tel.: +375 17 389 79 00
Fax: +375 17 389 79 51

Belgium

branch of SNA Europe (Benelux) BV
De Kleetlaan 12A Pegasus Park
1831 DIEGEM
Tel: +32 (0)2 726 03 03
Fax: +32 (0)2 726 04 36

Chile

Av. Americo Vespuccio 2760-D
Conchali - Santiago - Chile
Tel.: + 56 2 623 0203
Fax.: + 56 2 623 5395

Česká republika

SNA Europe [Czech republic] s.r.o.
Holadnská 2/4
639 00 Brno
Tel.: +420 537 022 520
Fax: +420 537 022 200

Danmark

Vallensbækvej 40,
2605 Brøndby
Tel: +45 4363 0330
Fax: +45 4396 2456

Deutschland

Willetstraße 10
40822 Mettmann
Tel: +49 (0) 2104 8 33 83 0
Fax: +49 (0) 2104 833 83 79 99

España

c/ Hilanderas, 1
(P.O. Box / Apdo de Correos nº 5)
C.P. 20303 Irún
Tel: +34 902 235 100 / +34 943 649 111
Fax: +34 943 649 120

Ελλάδα

Λ. Βουλιαγμένης 604Γ
167 77 Ελληνικό, Αθήνα
Τηλ: +30 210 9914263
Fax: +30 210 9914587

France

ZAC de l'Hoire
20 rue Charles Lacretelle
CS 60101
49072 Beaucouzé cedex
Tél: +33 (0) 2 41 22 98 40
Fax: +33 (0) 2 41 22 98 50

International Sales Group

Antigua Carretera de Altube Km 5,5
P.O.Box 307
01080 VITORIA (Spain)
Tel.: +34 945269711
Fax: +34 945165040

Italia

Via Villapizzone 26
20156 Milano
Tel: +39 02 302 416 1
Fax: +39 02 380 036 98

Казахстан

050000, Алматы,
ул. Шевченко 1656/72г, оф. 217
Тел/факс : +7 727 323 63 39

Nederland

Vossenbeemd 113
5705 CL Helmond
Tel: +31 (0) 492 58 23 82
Fax: +31(0) 492 58 23 20

New Zealand

Unit 3/25 Highbrook Drive
East Tamaki
Auckland
Tel: +64 9-273 46 50
Fax: + 64-9-273-2453

Norge

Postboks 800
1306 Sandvika
Tel: +47 40 49 66 00
info.no@snaeurope.com

Österreich

Vienna, Nineteen
Mooslackengasse 17
A-1190 Wien
Tel: +49 (0) 2104 8 33 83 0
Fax +49 (0) 2104 833 83 79 99

Polska

ul. Marynarska 15
02-674 Warszawa
Tel.: +48 (0) 22 6070510
Fax.: +48 (0) 22 6070521

Российская Федерация

141407, Московская область, г.
Химки, ул.Панфилова, вл.21, стр.1
Тел: +7(495) 2215851
Факс: +7(495) 2215851 (доб.3413)

Portugal

SNA Europe [Industries] LDA
R. Maria Julia M. Ramos - Junqueira
4480-254 Vila Do Conde
Tel. +351 252 650 131
Fax. +351 252 650 160

Slovenská republika

SNA Europe s.r.o.
Karadžičova 8/A
821 08 Bratislava
Tel.: +421 (0)2 5939 6124
Fax: +421 (0)2 5939 6217

Suomi

SNA Europe (Finland) Oy
PL 6580
00002 HELSINKI
Tel: +358 207 433 510
Fax: +358 207 433 525

Sverige

Box 83
SE-745 22 Enköping
Tel: +46 (0) 171-47 82 00
Fax: +46 (0) 171-47 82 38

Schweiz / Suisse

Willetstraße 10
D-40822 Mettmann
Deutschland
Tel: +49 (0) 2104 8 33 83 0
Fax +49 (0) 2104 833 83 79 99

Türkiye

Girne Mah. Maltepe Küçük San. Sitesi
F Blok No:19 Maltepe
Istanbul
Tel: +90 (0) 216 367 10 21
Fax: +90 (0) 216 367 11 71

Україна

Україна, 02140, м. Київ
вул. Єлизавети Чавдар, 9, офіс «А»
Tel: +38 044 220 45 58
Fax: +38 044 220 45 58

United Kingdom

Moorhead Way, Bramley,
Rotherham, South Yorkshire S66 1YY
Tel: +44 (0) 1709 731731
Fax: +44 (0) 1709 731741

Garantía

1. Todas las herramientas del catálogo (en los casos permitidos por la ley) ofrecen una garantía de por vida; una garantía que protege a la herramienta de defectos de material y de fabricación durante su vida natural. “De por vida” se define como el periodo de tiempo que se puede esperar dure una herramienta en condiciones de uso normales.
2. La gama de herramientas eléctricas, neumáticas y de medición de SNA Europe está excluida del punto 1, ya que cada una de dichas familias tiene su tarjeta de garantía específica, suministrada con el producto, que cubre condiciones de garantía especiales. Los productos se fabrican y diseñan para uso profesional. Normalmente el periodo de garantía es de un año (12 meses) para las herramientas de uso profesional y de dos años (24 meses) para las de uso particular. El periodo de garantía comienza con la fecha de compra. Esta fecha se puede comprobar en la factura o en cualquier otro documento de equivalente valor legal.
3. Cualquier producto defectuoso será reparado, reemplazado o sustituido. SNA Europe no se hace responsable del coste del transporte del producto a reparar, reemplazar o sustituir.
4. Cualquier producto que se haya utilizado o mantenido de forma incorrecta, o haya sufrido un mayor desgaste debido a un uso inadecuado, o haya sufrido modificaciones no autorizadas, no estará cubierto por esta garantía.
5. La reclamación de garantía debe presentarse dentro del periodo de garantía. Esto exige la entrega o el envío al vendedor o distribuidor de la herramienta completa en cuestión con la verificación de la documentación de venta, que debe validar la fecha de compra y la designación de la herramienta.
6. La sustitución o reparación del producto se efectuará lo antes posible. A la recepción del producto a reemplazar o sustituir, se pedirá su conformidad al cliente. Los repuestos y reparaciones del producto bajo esta garantía no alargarán o renovarán el periodo de garantía de la herramienta.

SNAEurope



Este catálogo comprende nuestra gama actual de productos. De manera regular se realizan cambios tanto en la gama de productos como en el conformado final, formas, diseños y designaciones de los mismos. Estas modificaciones no serán necesariamente notificadas.

Las ilustraciones y croquis han sido reproducidos para ser lo más precisos posibles. Sin embargo, en la elaboración de un catálogo, los mismos pueden diferir respecto a los propios productos y a las especificaciones técnicas.

Las indicaciones de peso deben entenderse como pesos netos aproximados, y sirven principalmente para facilitar el cálculo de los costes de transporte y franqueo.

Este catálogo reemplaza todas las especificaciones y gamas previas.

La propiedad intelectual de este catálogo pertenece a SNA Europe.

Los extractos, reimpresiones o copias de los contenidos solo se pueden realizar con nuestra autorización.

2020



B

A

E

R

O



M-325-CAT-20



7 314 150 452378