











-  Cric idropneumatici per camion
-  **Hydropneumatic heavy duty jacks**
-  Hydropneumatische LKW-Heber
-  Crics hydropneumatiques pour poids lourds
-  Gatos hidro-neumáticos para camión



-  Costruzione robusta per lavoro intensivo • Ruote con cuscinetto a sfera • Valvola limitatrice di carico
-  **Heavy duty design • Wheels with ball bearings • Overload safety valve**
-  Sehr robuste Konstruktion für intensive Arbeiten • Kugelgelagerte Räder • Überlastventil
-  Construction très robuste pour travail intensif • Roulettes avec roulement à billes • Soupape de surcharge
-  Construcción robusta para trabajo pesado • Ruedas con cojinete de bolas • Válvula limitadora de carga



Dati tecnici

Technical data

Technische Eigenschaften

Caractéristiques techniques

Datos técnicos

					W133	W137
Portata	Capacity	Capacité	Tragfähigkeit	Capacidad de carga	70/43/23/13 t	44/32/22/14/8 t
Peso	Weight	Poids	Gewicht	Peso	77 kg	63 kg
Pressione	Pressure	Pression	Luftdruck	Presión	8 - 10 bar	8 - 10 bar

W133

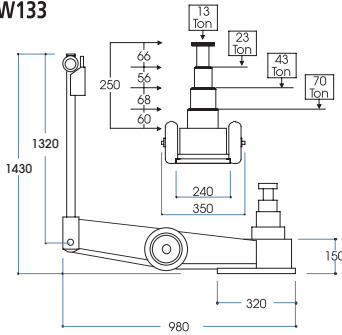

W137

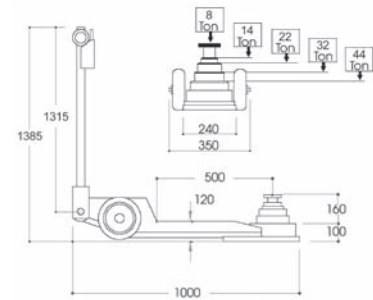

- Kit Prolunghe (10,70,120 mm)
- Extension kit (10,70,120 mm)**
- Verlängerungssatz (10,70,120 mm)
- Kit de rallonges (10,70,120 mm)
- Juego prolongaciones (10, 70, 120 mm)