











-  Cric idraulici a carrello
-  Hydraulic trolley jacks
-  Hydraulische Rangierheber
-  Crics rouleurs hydrauliques
-  Gatos hidráulicos con carrito



-  Manico ergonomico per il comfort dell'utilizzatore. Ricoperto in gomma • Il sistema di discesa "solleva e gira" previene abbassamenti non intenzionali • Valvola di controllo abbassamento per una discesa sicura perfino con il massimo carico • Il pedale a piede addizionale permette un sollevamento veloce della sella • Ruote a diametro largo per movimentazione facile.
-  Ergonomically designed handle for operator comfort. Rubber coated • "Lift-and-turn" lowering system prevents unintentional lowering • Safety lowering control valve for safe lowering even under maximum load • Additional foot pedal pumping feature provides fast saddle raising to the load • Large diameter swivel wheels for easy handling.
-  Ergonomisch geformte gummiüberzogene Griffe für besseren Bedienkomfort • Heben und Drehen, Absenksystem schützt gegen unbeabsichtigtes Absacken von Lasten • Ein Sicherheitsventil zur Steuerung des Absenkvorganges gewährleistet das Ablassen von Lasten mit definierter Geschwindigkeit und schützt gegen unbeabsichtigtes Absacken von Lasten auch unter max. Traglast • Zusätzliches Fußpedal zum schnellen Hochfahren des Sattels (Schnellhub) • Grosse Schwenkrollen für Stabilität und Wendigkeit unter Last.
-  Poignée de conception ergonomique pour un grand confort d'utilisation. Revêtement de caoutchouc • "Dispositif de descente "levage et blocage" empêchant toute descente intempestive • La pédale additionnelle de pompage assure un levage rapide du sabot d'appui vers la charge • Vanne-pilote de sécurité pour une descente sûre, même sous la charge maximale • Roues pivotantes de grand diamètre pour manutention facile.
-  Mango ergonómico para el confort del usuario. Revestido en goma • El sistema de descenso "eleva y gira" precave bajadas no intencionadas • Válvula de control de bajada para un descenso seguro también con la carga máxima • El pedal adicional permite una elevación rápida de la silla • Ruedas de diámetro grande para un desplazamiento facilitado.



Dati tecnici

Technical data

Technische Eigenschaften

Caractéristiques techniques

Datos técnicos

MOD.	Max (Ton)	A (mm)	B (mm)	C (mm)	D (mm)	E (mm)	F (mm)	Kg
WJC2T-C	2	80	500	730	160	380	925	37
WJF2T-77	2	77	480	950	126	380	925	41
WJC3T-C	3	115	500	1015	170	380	925	42

Ruote in nylon per la riduzione del rumore

Noise reducing nylon wheels

Serienmäßig mit geräuscharmen Kunststoffräder

Roues en nylon silencieuses

Ruedas en nylon para reducir el ruido

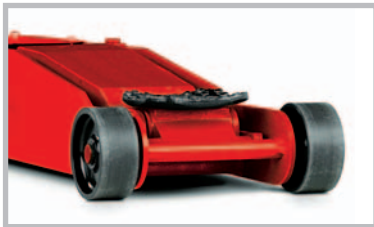
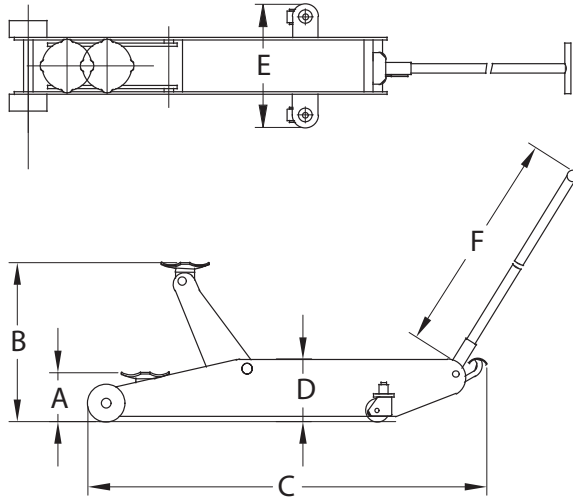

Altezza di entrata ultra bassa

Ultra low entry height

Ultraflache Aufnahmehöhe

Prise très basse de la charge

Altura de entrada ultra baja



Opzioni

Optionals

Sonderzubehör

Options

Opcionales



CD0601

WJC2T-C - WJF2T-F

Il sistema boogie è ideale per le officine con pavimento non pari ed all'esterno - Rulli e ruote in poliuretano

The boogie system is ideal for workshops with uneven floors and outdoors - Polyurethane rollers and wheels

Ideal für Karosserie Die Boogie - und Lackierwerkstätten - Rollen und Räder aus Polyurethan

Les roues boogie sont idéales pour les ateliers aux sols inégaux et à l'extérieur des bâtiments - Rouleaux et roues en polyurÉthane

El sistema de ruedas boogie es ideal para los talleres con piso irregular y al aire libre - Rodillos y ruedas de poliuretano



CD0603

WJF2T-F (+40mm) - WJ3T-C (+40mm)

Sella per altezze extra o accesso a punti di sollevamento posti sotto alle minigonne, etc.

Saddle for extra height or accessing lifting points situated behind skirts, etc.

Sattelverlängerung für extra hohe Aufnahmen oder schwer zugängliche Hebepunkte, z.B. Hinter Blenden.

Selle pour hauteurs exceptionnelles ou pour l'accès à des points de levage situés hors limites, etc.

Silla para alturas extra o acceso a puntos de elevación situados debajo de las minifaldas, etc.



CD0602

Tappo in gomma

Rubber pad

Gummiauflage

Tampon en caoutchouc

Tapón de goma